

SE400 Series

USER MANUAL



B+B SMARTWORX

Powered by

ADANTECH

Advantech B+B SmartWorx - Americas

707 Dayton Road
Ottawa, IL 61350 USA
Phone (815) 433-5100
Fax (815) 433-5105

Advantech B+B SmartWorx - European Headquarters

Westlink Commercial Park
Oranmore, Co. Galway, Ireland
Phone +353 91-792444
Fax +353 91-792445

www.advantech-bb.com
support@advantech-bb.com

CONTENTS

Product Overview 1

- Supported Models..... 1
- Specifications..... 1
- Hardware Views..... 3
 - Front View..... 3
 - Rear View 8
 - Top View..... 9
 - Bottom View..... 10

Switch Installation 12

- Installation Guidelines..... 12
 - Connecting Hardware 12
- Verifying Switch Operation 12
- Installing the Switch 13
 - DIN Rail Mounting..... 13
 - Wall-Mounting..... 15
- Installing and Removing SFP Modules 17
 - Installing SFP Modules 17
 - Removing SFP Modules 19
- Connecting the Switch to Ethernet Ports 20
 - RJ45 Ethernet Cable Wiring 20
- Power Supply Installation 20
 - Overview..... 20
 - Considerations..... 21
 - Grounding the Device 22
 - Wiring a Relay Contact 23
 - Wiring the Power Inputs..... 23

Managing Switch 26

- First Time set up 26
 - Overview..... 26
 - SCADA Requirements 26
 - Administrative Interface Access..... 26
 - Using the Graphical (Web) Interface 27
 - Configuring the Switch for Network Access..... 27
 - Configuring the Ethernet Ports 27
- Web Browser Configuration..... 29
 - Preparing for Web Configuration 29
- Log In..... 29
- Recommended Practices..... 30
 - Changing Default Password 30
- Monitoring 31
 - Device Information..... 31
 - Logging Message 32
 - Port Monitoring 33
 - Link Aggregation..... 34
 - LLDP Statistics 34
 - IGMP Statistics 35

System.....	36
IP Settings	36
DHCP Client Option 82.....	37
DHCP Auto Provision	38
IPv6 Settings.....	38
Management VLAN	39
System Time.....	40
L2 Switching	41
Port Configuration.....	41
Port Mirror.....	42
Link Aggregation.....	43
802.1Q VLAN.....	46
GARP.....	49
802.3az EEE.....	50
Multicast.....	51
SCADA Requirements	51
Jumbo Frame.....	56
Spanning Tree	57
X-Ring Elite.....	62
Loopback Detection	63
MAC Address Table.....	65
Static MAC.....	65
MAC Aging Time.....	66
Dynamic Forwarding Table.....	66
Security	67
Storm Control.....	67
Port Security	69
Protected Ports	69
DoS Prevention.....	70
Applications	72
802.1x.....	73
QoS.....	75
General.....	75
QoS Basic Mode.....	81
Rate Limit.....	82
Management.....	84
LLDP.....	84
SNMP	87
Diagnostics	91
Cable Diagnostics.....	91
Ping Test.....	92
IPv6 Ping Test	93
System Log.....	94
DDM.....	97
Tools	98
IXM	98
Backup Manager.....	99
Upgrade Manager.....	100
Dual Image	101
Save Configuration	101
User Account	102
Reset System	102
Reboot Device	102

Troubleshooting 103

Advantech B+B Smartworx Technical support 103

LIST OF FIGURES

Figure 1: Front View 3

Figure 2: Front View 4

Figure 3: Front View 5

Figure 4: Front View 6

Figure 5: System LED Panel 7

Figure 6: Rear View 8

Figure 7: Rear View 9

Figure 8: Top View..... 9

Figure 9: Top View..... 10

Figure 10: Bottom View 10

Figure 11: Bottom View 11

Figure 12: Installing the DIN-Rail Mounting Kit..... 13

Figure 13: Removing the DIN-Rail..... 14

Figure 14: Installing Wall Mount Plates 15

Figure 15: Securing Wall Mounting Screws..... 16

Figure 16: Wall Mount Installation 16

Figure 17: Removing the Dust Plug from an SFP Slot 17

Figure 18: Installing an SFP Transceiver..... 18

Figure 19: Attaching a Fiber Optic Cable to a Transceiver..... 18

Figure 20: Removing a Fiber Optic Cable to a Transceiver..... 19

Figure 21: Removing an SFP Transceiver..... 19

Figure 22: Ethernet Plug & Connector Pin Position 20

Figure 23: Power Wiring for SE400 Series 21

Figure 24: Grounding Connection..... 22

Figure 25: Terminal Receptor: Relay Contact 23

Figure 26: Terminal Receptor: Power Input Contacts..... 23

Figure 27: Removing a Terminal Block..... 24

Figure 28: Installing DC Wires in a Terminal Block 24

Figure 29: Installing DC Wires in a Terminal Block 24

Figure 30: Securing a Terminal Block to a Receptor 25

Figure 31: Login Screen 29

Figure 32: Changing a Default Password 30

Figure 33: Monitoring > Device Information..... 31

Figure 34: Monitoring > Logging Message 32

Figure 35: Monitoring > Port Monitoring > Port Statistics 33

Figure 36: Monitoring > Port Monitoring > Port Utilization 33

Figure 37: Monitoring > LLDP Statistics 34

Figure 38: Monitoring > IGMP Statistics 35

Figure 39: System > IP Settings 36

Figure 40: System > DHCP Client Option 82..... 37

Figure 41: System > DHCP Auto Provision 38

Figure 42: System > IPv6 Settings 38

Figure 43: System > Management VLAN 39

Figure 44: System > System Time..... 40

Figure 45: L2 Switching > Port Configuration 41

Figure 46: L2 Switching > Port Mirror 42

Figure 47: L2 Switching > Link Aggregation > Load Balance 43

Figure 48: L2 Switching > Link Aggregation > LAG Management..... 43

Figure 49: L2 Switching > Link Aggregation > LAG Port Settings 44

Figure 50: L2 Switching > Link Aggregation > LACP Priority Settings 45

Figure 51: L2 Switching > Link Aggregation > LACP Port Settings 45

Figure 52: L2 Switching > 802.1Q VLAN > VLAN Management 46

Figure 53: L2 Switching > 802.1Q VLAN > PVID Settings 47

Figure 54: L2 Switching > 802.1Q VLAN > Port to VLAN..... 48

Figure 55: L2 Switching > GARP > GARP Settings..... 49

Figure 56:	L2 Switching > GARP > GVRP Settings	50
Figure 57:	L2 Switching > 802.3az EEE	50
Figure 58:	L2 Switching > Multicast > Multicast Filtering	51
Figure 59:	L2 Switching > Multicast > IGMP Snooping > IGMP Settings	52
Figure 60:	L2 Switching > Multicast > IGMP Snooping > IGMP Querier	52
Figure 61:	L2 Switching > Multicast > IGMP Snooping > IGMP Static Groups	53
Figure 62:	L2 Switching > Multicast > MLD Snooping > MLD Settings	54
Figure 63:	L2 Switching > Multicast > MLD Snooping > MLD Querier	55
Figure 64:	L2 Switching > Multicast > MLD Snooping > MLD Static Group	55
Figure 65:	L2 Switching > Jumbo Frame	56
Figure 66:	L2 Switching > Spanning Tree > STP Global Settings	57
Figure 67:	L2 Switching > Spanning Tree > STP Port Settings	58
Figure 68:	L2 Switching > Spanning Tree > STP Bridge Settings	59
Figure 69:	L2 Switching > Spanning Tree > STP Port Advanced Settings	60
Figure 70:	L2 Switching > Spanning Tree > MST Config Identification	60
Figure 71:	L2 Switching > Spanning Tree > MST Instance ID Settings	61
Figure 72:	L2 Switching > Spanning Tree > MST Instance Priority Settings	61
Figure 73:	L2 Switching > X-Ring Elite > X-Ring Elite Settings	62
Figure 74:	L2 Switching > X-Ring Elite > X-Ring Elite Groups	63
Figure 75:	L2 Switching > Loopback Detection > Global Settings	63
Figure 76:	L2 Switching > Loopback Detection > Port Settings	64
Figure 77:	MAC Address Table > Static MAC	65
Figure 78:	MAC Address Table > MAC Aging Time	66
Figure 79:	MAC Address Table > Dynamic Forwarding Table	66
Figure 80:	Security > Storm Control > Global Settings	67
Figure 81:	Security > Storm Control > Port Settings	68
Figure 82:	Security > Port Security	69
Figure 83:	Security > Protected Ports	69
Figure 84:	Security > DoS Prevention > DoS Global Settings	70
Figure 85:	Security > DoS Prevention > DoS Port Settings	72
Figure 86:	Security > Applications > HTTP	72
Figure 87:	Security > 802.1x > 802.1x Settings	73
Figure 88:	Security > 802.1x > 802.1x Port Configuration	74
Figure 89:	QoS > General > QoS Properties	75
Figure 90:	QoS > General > QoS Settings	76
Figure 91:	QoS > General > QoS Scheduling	77
Figure 92:	QoS > General > CoS Mapping	78
Figure 93:	QoS > General > DSCP Mapping	79
Figure 94:	QoS > General > IP Precedence Mapping	80
Figure 95:	QoS > QoS Basic Mode > Global Settings	81
Figure 96:	QoS > QoS Basic Mode > Port Settings	81
Figure 97:	QoS > Rate Limit > Ingress Bandwidth Control	82
Figure 98:	QoS > Rate Limit > Egress Bandwidth Control	83
Figure 99:	QoS > Rate Limit > Egress Queue	83
Figure 100:	Management > LLDP > LLDP System Settings	84
Figure 101:	Management > LLDP > LLDP Port Settings > LLDP Port Configuration	85
Figure 102:	Management > LLDP > LLDP Port Settings > Optional TLVs Selection	85
Figure 103:	Management > LLDP > LLDP Port Settings > VLAN Name TLV VLAN Selection	86
Figure 104:	Management > LLDP > LLDP Remote Device Info	86
Figure 105:	Management > SNMP > SNMP Settings	87
Figure 106:	Management > SNMP > SNMP Community	88
Figure 107:	Management > SNMP > SNMP User Settings	89
Figure 108:	Management > SNMP > SNMP Trap	90
Figure 109:	Diagnostics > Cable Diagnostics	91
Figure 110:	Diagnostics > Ping Test	92
Figure 111:	Diagnostics > IPv6 Ping Test	93
Figure 112:	Diagnostics > System Log > Logging Service	94
Figure 113:	Diagnostics > System Log > Local Logging	95

Figure 114: Diagnostics > System Log > System Log Server	96
Figure 115: Diagnostics > DDM.....	97
Figure 116: Diagnostics > DDM > Diagnostic Alarm Information	97
Figure 117: Tools > IXM	98
Figure 118: Tools > Backup Manager.....	99
Figure 119: Tools > Upgrade Manager.....	100
Figure 120: Tools > Dual Image	101
Figure 121: Tools > User Account	102

LIST OF TABLES

Table 1:	Standard Models	1
Table 2:	Wide Temperature Models	1
Table 3:	Specifications	1
Table 4:	Front View	3
Table 5:	Front View	4
Table 6:	Front View	5
Table 7:	Front View	6
Table 8:	System LED Panel	7
Table 9:	Rear View	8
Table 10:	Rear View	9
Table 11:	Top View.....	9
Table 12:	Top View.....	10
Table 13:	Bottom View	10
Table 14:	Bottom View	11
Table 15:	Pin Definition	20
Table 16:	Monitoring > Device Information.....	31
Table 17:	Monitoring > Logging Message	32
Table 18:	Monitoring > Port Monitoring > Port Statistics	33
Table 19:	Monitoring > Port Monitoring > Port Utilization	33
Table 20:	Monitoring > LLDP Statistics	34
Table 21:	Monitoring > IGMP Statistics	35
Table 22:	System > IP Settings	36
Table 23:	System > DHCP Client Option 82.....	37
Table 24:	System > DHCP Auto Provision	38
Table 25:	System > IPv6 Settings	38
Table 26:	System > Management VLAN	39
Table 27:	System > System Time.....	40
Table 28:	L2 Switching > Port Configuration	41
Table 29:	L2 Switching > Port Mirror	42
Table 30:	L2 Switching > Link Aggregation > Load Balance	43
Table 31:	L2 Switching > Link Aggregation > LAG Management.....	43
Table 32:	L2 Switching > Link Aggregation > LAG Port Settings	44
Table 33:	L2 Switching > Link Aggregation > LACP Priority Settings	45
Table 34:	L2 Switching > Link Aggregation > LACP Port Settings.....	45
Table 35:	L2 Switching > 802.1Q VLAN > VLAN Management	46
Table 36:	L2 Switching > 802.1Q VLAN > PVID Settings	47
Table 37:	L2 Switching > 802.1Q VLAN > Port to VLAN.....	48
Table 38:	L2 Switching > GARP > GARP Settings.....	49
Table 39:	L2 Switching > GARP > GVRP Settings.....	50
Table 40:	L2 Switching > 802.3az EEE	50
Table 41:	L2 Switching > Multicast > Multicast Filtering.....	51
Table 42:	L2 Switching > Multicast > IGMP Snooping > IGMP Settings	52
Table 43:	L2 Switching > Multicast > IGMP Snooping > IGMP Querier	53
Table 44:	L2 Switching > Multicast > IGMP Snooping > IGMP Static Groups	53
Table 45:	L2 Switching > Multicast > MLD Snooping > MLD Settings	54
Table 46:	L2 Switching > Multicast > MLD Snooping > MLD Querier	55
Table 47:	L2 Switching > Multicast > MLD Snooping > MLD Static Group	55
Table 48:	L2 Switching > Jumbo Frame	56
Table 49:	L2 Switching > Spanning Tree > STP Global Settings	57
Table 50:	L2 Switching > Spanning Tree > STP Port Settings	58
Table 51:	L2 Switching > Spanning Tree > STP Bridge Settings	59
Table 52:	L2 Switching > Spanning Tree > STP Port Advanced Settings.....	60
Table 53:	L2 Switching > Spanning Tree > MST Config Identification	60
Table 54:	L2 Switching > Spanning Tree > MST Instance ID Settings.....	61
Table 55:	L2 Switching > Spanning Tree > MST Instance Priority Settings	61

Table 56:	L2 Switching > X-Ring Elite > X-Ring Elite Settings	62
Table 57:	L2 Switching > Loopback Detection > Global Settings	63
Table 58:	L2 Switching > Loopback Detection > Port Settings	64
Table 59:	MAC Address Table > Static MAC	65
Table 60:	MAC Address Table > MAC Aging Time	66
Table 61:	MAC Address Table > Dynamic Forwarding Table	66
Table 62:	Security > Storm Control > Global Settings	67
Table 63:	Security > Storm Control > Port Settings	68
Table 64:	Security > Port Security	69
Table 65:	Security > Protected Ports	69
Table 66:	Security > DoS Prevention > DoS Global Settings	71
Table 67:	Security > DoS Prevention > DoS Port Settings	72
Table 68:	Security > Applications > HTTP	72
Table 69:	Security > 802.1x > 802.1x Settings	73
Table 70:	Security > 802.1x > 802.1x Port Configuration	74
Table 71:	QoS > General > QoS Properties	75
Table 72:	QoS > General > QoS Settings	76
Table 73:	QoS > General > QoS Scheduling	77
Table 74:	QoS > General > CoS Mapping	78
Table 75:	QoS > General > DSCP Mapping	79
Table 76:	QoS > General > IP Precedence Mapping	80
Table 77:	QoS > QoS Basic Mode > Global Settings	81
Table 78:	QoS > QoS Basic Mode > Port Settings	81
Table 79:	QoS > Rate Limit > Ingress Bandwidth Control	82
Table 80:	QoS > Rate Limit > Egress Bandwidth Control	83
Table 81:	QoS > Rate Limit > Egress Queue	83
Table 82:	Management > LLDP > LLDP System Settings	84
Table 83:	Management > LLDP > LLDP Port Settings > LLDP Port Configuration	85
Table 84:	Management > LLDP > LLDP Port Settings > Optional TLVs Selection	85
Table 85:	Management > LLDP > LLDP Port Settings > VLAN Name TLV VLAN Selection	86
Table 86:	Management > LLDP > LLDP Remote Device Info	86
Table 87:	Management > SNMP > SNMP Settings	87
Table 88:	Management > SNMP > SNMP Community	88
Table 89:	Management > SNMP > SNMP User Settings	89
Table 90:	Management > SNMP > SNMP Trap	90
Table 91:	Diagnostics > Cable Diagnostics	91
Table 92:	Diagnostics > Ping Test	92
Table 93:	Diagnostics > IPv6 Ping Test	93
Table 94:	Diagnostics > System Log > Logging Service	94
Table 95:	Diagnostics > System Log > Local Logging	95
Table 96:	Diagnostics > System Log > System Log Server	96
Table 97:	Diagnostics > DDM	97
Table 98:	Diagnostics > DDM > Diagnostic Alarm Information	97
Table 99:	Tools > IXM	98
Table 100:	Tools > Backup Manager	99
Table 101:	Tools > Upgrade Manager	100
Table 102:	Tools > Dual Image	101
Table 103:	Tools > User Account	102

DECLARATION OF CONFORMITY

CE

This product has passed the CE test for environmental specifications when shielded cables are used for external wiring. We recommend the use of shielded cables. This kind of cable is available from Advantech. Please contact your local supplier for ordering information.

This product has passed the CE test for environmental specifications. Test conditions for passing included the equipment being operated within an industrial enclosure. In order to protect the product from being damaged by ESD (Electrostatic Discharge) and EMI leakage, we strongly recommend the use of CE-compliant industrial enclosure products.

FCC Class A

This equipment has been tested and found to comply with the limits for a Class A digital device, pursuant to part 15 of the FCC Rules. These limits are designed to provide reasonable protection against harmful interference when the equipment is operated in a commercial environment. This equipment generates, uses, and can radiate radio frequency energy and, if not installed and used in accordance with the instruction manual, may cause harmful interference to radio communications. Operation of this equipment in a residential area is likely to cause harmful interference in which case the user will be required to correct the interference at his own expense.

Safety Instructions

- Read these safety instructions carefully.
- Keep this user manual for later reference.
- Disconnect this equipment from any AC outlet before cleaning. Use damp cloth. Do not use liquid or spray detergents for cleaning.
- For plug-in equipment, the power outlet socket must be located near the equipment and must be easily accessible.
- Keep this equipment away from humidity.
- Put this equipment on a reliable surface during installation. Dropping it or letting it fall may cause damage.
- The openings on the enclosure are for air convection. Protect the equipment from overheating. **DO NOT COVER THE OPENINGS.**
- Make sure the voltage of the power source is correct before connecting the equipment to the power outlet.
- Position the power cord so that people cannot step on it. Do not place anything over the power cord.
- All cautions and warning on the equipment should be noted.
- If the equipment is not used for a long time, disconnect it from the power source to avoid damage by transient over voltage.
- Never pour any liquid into an opening. This may cause fire or electrical shock.
- Never open the equipment. For safety reasons, the equipment should be opened only by qualified service personnel.
- If one of the following situations arises, get the equipment checked by service personnel:
 - The power cord or plug is damaged.
 - Liquid has penetrated into the equipment.

- The equipment has been exposed to moisture.
- The equipment does not work well, or you cannot get it to work according to the user manual
- The equipment has been dropped and damaged.
- The equipment has obvious signs of breakage.
- Instructions for installation in a pollution Degree 2 environment or equivalent statement.
- PoE requirements:
This product was in-door used and not connected to outside plant, so user manual shall have the description as below or equivalent: “The equipment is to be connected only to PoE networks without routing to the outside plant.”
- Do NOT LEAVE THIS EQUIPMENT IN AN ENVIRONMENT WHERE THE STORAGE TEMPERATURE MAY GO BELOW -40°C(-40°F) OR ABOVE 75°C(167°F) THIS COULD DAMAGE THE EQUIPMENT. THE EQUIPMENT SHOULD BE IN A CONTROLLED ENVIRONMENT.

PRODUCT WARRANTY – LIMITED LIFETIME

Effective for products of Advantech B+B SmartWorx shipped on or after May 1, 2013, Advantech B+B SmartWorx warrants that each such product shall be free from defects in material and workmanship for its lifetime. This limited lifetime warranty is applicable solely to the original user and is not transferable. Power supplies are exempt from the limited lifetime warranty and are covered by a six year warranty.

This warranty is expressly conditioned upon proper storage, installation, connection, operation and maintenance of products in accordance with their written specifications.

Pursuant to the warranty, within the warranty period, Advantech B+B SmartWorx, at its option will:

1. Replace the product with a functional equivalent;
2. Repair the product; or
3. Provide a partial refund of purchase price based on a depreciated value.

Products of other manufacturers sold by Advantech B+B SmartWorx are not subject to any warranty or indemnity offered by Advantech B+B SmartWorx, but may be subject to the warranties of the other manufacturers.

Notwithstanding the foregoing, under no circumstances shall Advantech B+B SmartWorx have any warranty obligations or any other liability for: (i) any defects resulting from wear and tear, accident, improper use by the buyer or use by any third party except in accordance with the written instructions or advice of the Advantech B+B SmartWorx or the manufacturer of the products, including without limitation surge and overvoltage conditions that exceed specified ratings, (ii) any products which have been adjusted, modified or repaired by any party other than Advantech B+B SmartWorx or (iii) any descriptions, illustrations, figures as to performance, drawings and particulars of weights and dimensions contained in the Advantech B+B SmartWorx' catalogs, price lists, marketing materials or elsewhere since they are merely intended to represent a general idea of the products and do not form part of this price quote and do not constitute a warranty of any kind, whether express or implied, as to any of the Advantech B+B SmartWorx's products.

THE REPAIR OR REPLACEMENT OF THE DEFECTIVE ITEMS IN ACCORDANCE WITH THE EXPRESS WARRANTY SET FORTH ABOVE IS ADVANTECH B+B SMARTWORX SOLE OBLIGATION UNDER THIS WARRANTY. THE WARRANTY CONTAINED IN THIS SECTION SHALL EXTEND TO THE ORIGINAL USER ONLY, IS IN LIEU OF ANY AND ALL OTHER WARRANTIES, EXPRESS OR IMPLIED, AND ALL SUCH WARRANTIES AND INDEMNITIES ARE EXPRESSLY DISCLAIMED, INCLUDING WITHOUT LIMITATION (I) THE IMPLIED WARRANTIES OF FITNESS FOR A PARTICULAR PURPOSE AND OF MER-

CHANTABILITY AND (II) ANY WARRANTY THAT THE PRODUCTS ARE DO NOT INFRINGE OR VIOLATE THE INTELLECTUAL PROPERTY RIGHTS OF ANY THIRD PARTY. IN NO EVENT SHALL ADVANTECH B+B SMARTWORX BE LIABLE FOR LOSS OF BUSINESS, LOSS OF USE OR OF DATA INTERRUPTION OF BUSINESS, LOST PROFITS OR GOODWILL OR OTHER SPECIAL, INCIDENTAL, EXEMPLARY OR CONSEQUENTIAL DAMAGES. ADVANTECH B+B SMARTWORX SHALL DISREGARD AND NOT BE BOUND BY ANY REPRESENTATIONS, WARRANTIES OR INDEMNITIES MADE BY ANY OTHER PERSON, INCLUDING WITHOUT LIMITATION EMPLOYEES, DISTRIBUTORS, RESELLERS OR DEALERS OF ADVANTECH B+B SMARTWORX WHICH ARE INCONSISTENT WITH THE WARRANTY, SET FORTH ABOVE.

RETURNS POLICY

Eligible items returned within 30 days of purchase qualify for a full refund (less shipping charges). Advantech B+B SmartWorx has the option to accept returns of products 30 days after the date of purchase and such returns are subject to a restocking fee of up to 20%. Software is not returnable if opened. Advantech B+B SmartWorx will not accept returns of products that were modified by a customer. All custom orders are non-returnable and non-cancelable.

REPAIR SERVICE: We offer a repair service for our products. Please call, FAX, or e-mail to request a Return Material Authorization (RMA) number and routing instructions. Shipping charges and any duties, taxes or brokerage fees are the customer's responsibility.

RETURN AND REPAIR CONTACT INFORMATION

Phone: (815) 433-5100 7:00 AM - 7:00 PM CST

Fax: (815) 433-5109

Email: orders@advantech-bb.com

WARNINGS, CAUTIONS AND NOTES

Warning! *Warnings indicate conditions, which if not observed, can cause personal injury!*



Caution! *Cautions are included to help you avoid damaging hardware or losing data. e.g.*



There is a danger of a new battery exploding if it is incorrectly installed. Do not attempt to recharge, force open, or heat the battery. Replace the battery only with the same or equivalent type recommended by the manufacturer. Discard used batteries according to the manufacturer's instructions.

Note! *Notes provide optional additional information.*



PRODUCT OVERVIEW

Supported Models

Standard Models:

Table 1: Standard Models

SE408	SEC410-2SFP	SE416
SEC418-2SFP		

Wide Temperature Models:

Table 2: Wide Temperature Models

SE408-EI-T	SE408-PN-T	SE408-PNMA-T
SE408-T	SEC410-2SFP-EI-T	SEC410-2SFP-PN-T
SEC410-2SFP-T	SE416-EI-T	SE416-PN-T
SE416-T	SEC418-2SFP-EI-T	SEC418-2SFP-PN-T
SEC418-2SFP-T		

Specifications

Table 3: Specifications

Specifications	Description	
Interface	I/O Port	<ul style="list-style-type: none"> ■ SE408 series: 8 x 10/100BaseT(X) ■ SE416 series: 16 x 10/100BaseT(X) ■ SEC410 series: 8 x 10/100BaseT(X) + 2 x 10/100Base-T(X) or 100Base-FX SFP ■ SEC418 series: 16 x 10/100BaseT(X) + 2 x 10/100Base-T(X) or 100Base-FX SFP
	Power Connector	6-pin screw Terminal Block (including relay)
Physical	Enclosure	Metal Shell
	Protection Class	IP30
	Installation	DIN-Rail and Wall-Mount
	Dimensions (W x H x D)	<ul style="list-style-type: none"> ■ SE408 series: 43mm x 120mm x 84mm (1.69in x 4.72in x 3.3in) ■ SE416 series: 74mm x 120mm x 84mm (2.91in x 4.72in x 3.3in) ■ SEC410 series: 74mm x 120mm x 84mm (2.91in x 4.72in x 3.3in) ■ SEC418 series: 74mm x 120mm x 84mm (2.91in x 4.72in x 3.3in)
LED Display	System LED	PWR1, PWR2, P-Fail, Loop detection PoE
	Port LED	Link / Speed / Activity

Table 3: Specifications (Continued)

Specifications	Description	
Environment	Operating Temperature	Standard Temperature: -10°C ~ 60°C (14°F ~ 140°F) Wide Temperature: -40°C ~ 75°C (-40°F ~ 167°F)
	Storage Temperature	-40°C ~ 85° C (-40°F ~ 185° F)
	Ambient Relative Humidity	10 ~ 95% (non-condensing)
Switch Properties	MAC Address	8K entries
	Switching Bandwidth	<ul style="list-style-type: none"> ■ SE408 series : 1.6Gbps ■ SE416 series : 3.2Gbps ■ SEC410 series: 5.6Gbps ■ SEC418 series: 7.2Gbps
Power	Power Consumption	<ul style="list-style-type: none"> ■ SE408 series: 5.2 watts ■ SE416 series: 8 watts ■ SEC410 series: 5.8 watts ■ SEC418 series: 8.2 watts
	Power Input	12V ~ 48V (8.4V ~ 52.8V), redundant dual inputs
Certifications	Safety	<ul style="list-style-type: none"> ■ IEC/EN 60950-1, UL508 ■ Class 1 Division 2, IECEX, ATEX
	EMC	CE, FCC
	EMI	EN 55011/ 55022 Class A, EN 61000-6-4, FCC Part 15 Subpart B Class A
	EMS	<ul style="list-style-type: none"> ■ EN 55024/ EN 61000-6-2 ■ EN 61000-4-2 (ESD) Level 3 ■ EN 61000-4-3 (RS) Level 3 ■ EN 61000-4-4 (EFT) Level 3 ■ EN 61000-4-5 (Surge) Level 3 ■ EN 61000-4-6 (CS) Level 3 ■ EN 61000-4-8 (Magnetic Field) Level 3
	Shock	IEC 60068-2-27
	Freefall	IEC 60068-2-32
	Vibration	IEC 60068-2-6

Hardware Views

Front View

The following view applies to SE408 series.

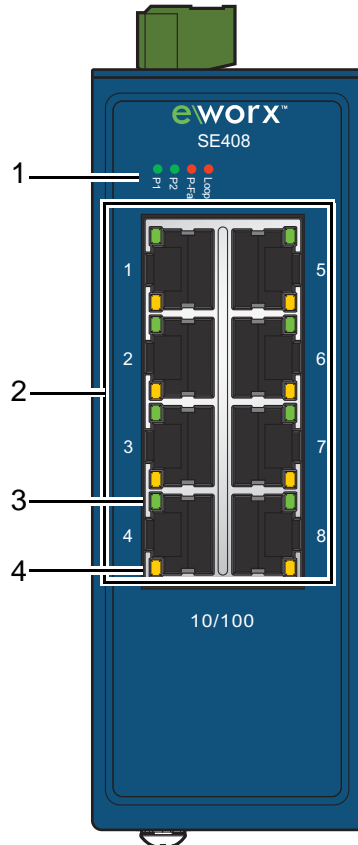

Figure 1: Front View

Table 4: Front View

No.	Item	Description
1	System LED panel	See "System LED Panel" on page 7 for further details.
2	ETH port	Eight 10/100BaseT(X) ports.
3	LNK/ACT LED	Link activity LED.
4	Speed LED	<ul style="list-style-type: none"> ■ Gigabit Ethernet: <ul style="list-style-type: none"> - Green: 1000M - Amber: 100M - Off: 10M ■ Fast Ethernet: <ul style="list-style-type: none"> - Amber: 100M - Off: 10M

The following view applies to SE416 series.

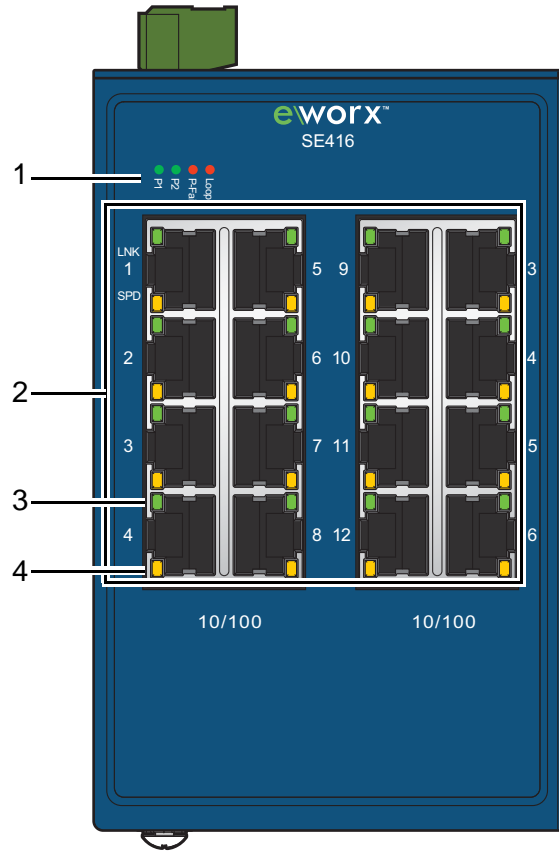

Figure 2: Front View

Table 5: Front View

No.	Item	Description
1	System LED panel	See "System LED Panel" on page 7 for further details.
2	ETH port	Sixteen 10/100BaseT(X) ports.
3	LNK/ACT LED	Link activity LED.
4	Speed LED	<ul style="list-style-type: none"> ■ Fast Ethernet: – Amber: 100M – Off: 10M

The following view applies to SEC410 series.

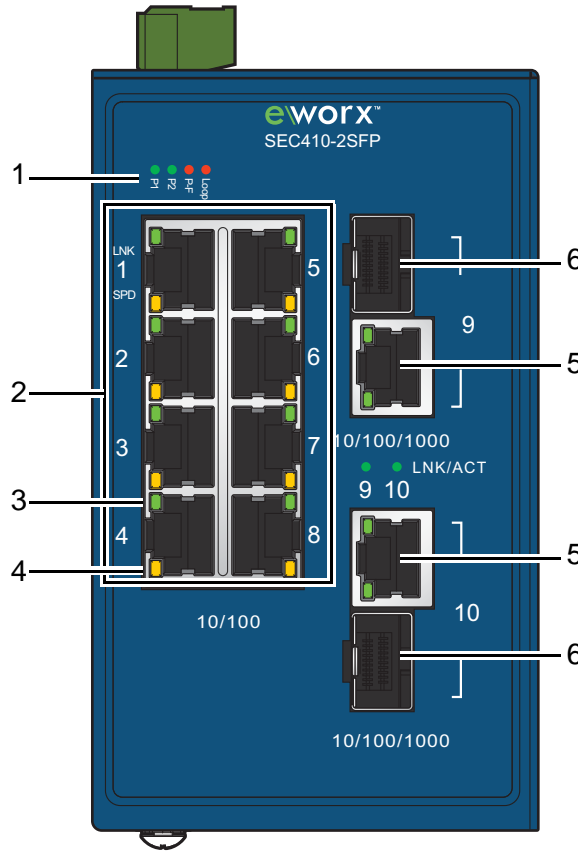

Figure 3: Front View

Table 6: Front View

No.	Item	Description
1	System LED panel	See "System LED Panel" on page 7 for further details.
2	ETH port	Eight 10/100BaseT(X) ports + two 100/1000BaseT(X) combo ports.
3	LNK/ACT LED	Link activity LED.
4	Speed LED	<ul style="list-style-type: none"> ■ Gigabit Ethernet: <ul style="list-style-type: none"> - Green: 1000M - Amber: 100M - Off: 10M
5	ETH port	Two 10/100/1000BaseT(X) ports.
6	ETH port	Two 100/1000Base-FX SFP ports.

The following view applies to SEC418 series.

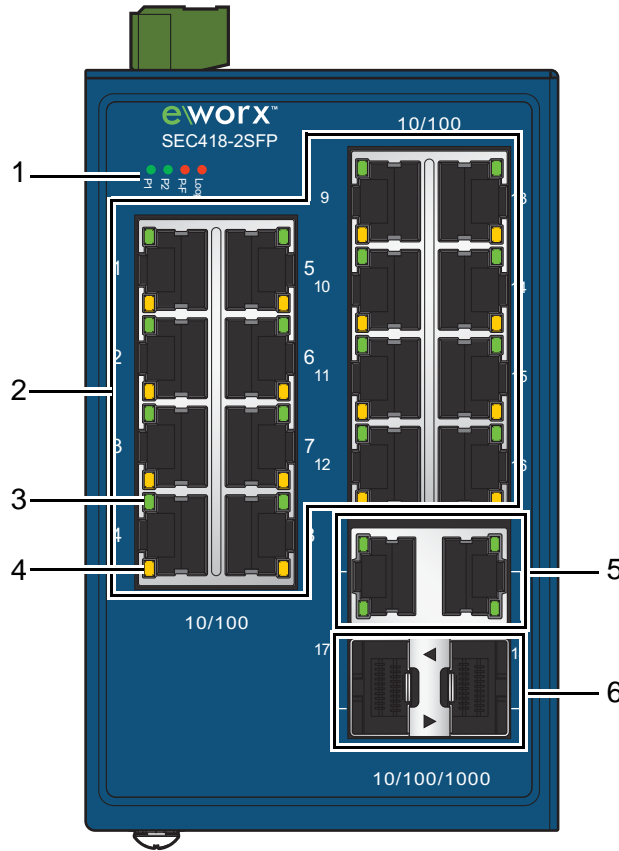

Figure 4: Front View

Table 7: Front View

No.	Item	Description
1	System LED panel	See "System LED Panel" on page 7 for further details.
2	ETH port	Sixteen 10/100BaseT(X) ports + two 100/1000BaseT(X) combo ports.
3	LNK/ACT LED	Link activity LED.
4	Speed LED	<ul style="list-style-type: none"> ■ Gigabit Ethernet: <ul style="list-style-type: none"> - Green: 1000M - Amber: 100M - Off: 10M
5	ETH port	Two 10/100/1000BaseT(X) ports.
6	ETH port	Two 100/1000Base-FX SFP ports.

System LED Panel

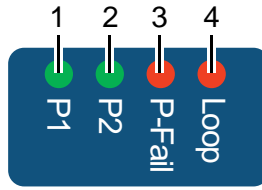

Figure 5: System LED Panel

Table 8: System LED Panel

No.	LED Name	LED Color	Description
1	PW1 LED	Solid green	Powered up.
		Off	Powered down or not installed.
2	PW2 LED	Solid green	Powered up.
		Off	Powered down or not installed.
3	P-Fail	Solid red	When PW1 or PW2 is disconnected, the LED lights.
		Off	When PW1 and PW2 is connected, the LED is off.
4	Loop	Solid red	When loop detected, the LED lights.
		Off	No loop detected.

Rear View

The following view applies to SE408 series.

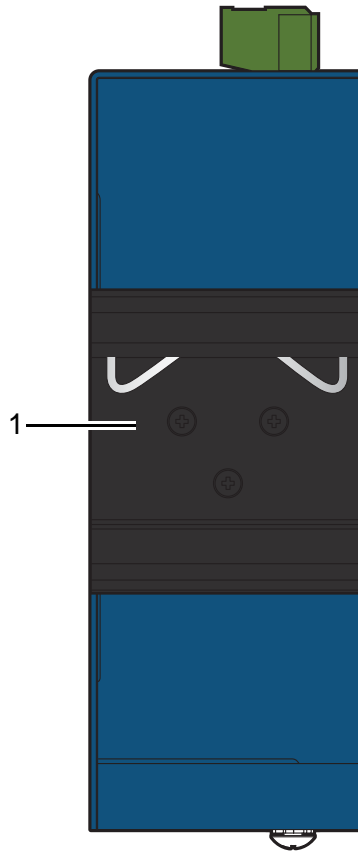

Figure 6: Rear View

Table 9: Rear View

No.	Item	Description
1	DIN-Rail mounting plate	Mounting plate used for the installation to a standard DIN rail.

The following view applies to SE416, SEC410, SEC418 series.

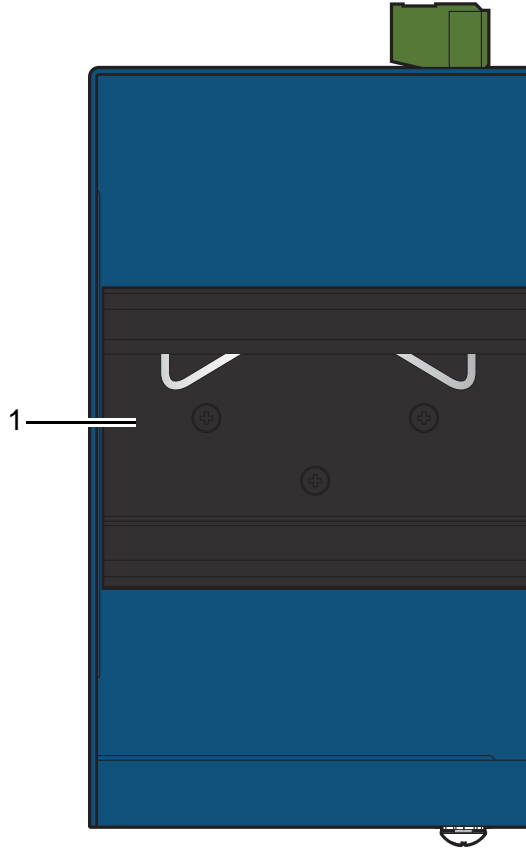

Figure 7: Rear View

Table 10: Rear View

No.	Item	Description
1	DIN-Rail mounting plate	Mounting plate used for the installation to a standard DIN rail.

Top View

The following view applies to SE408 series.

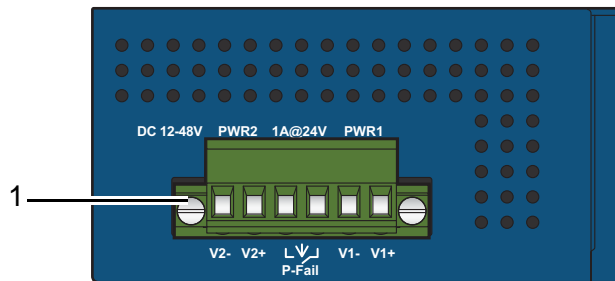

Figure 8: Top View

Table 11: Top View

No.	Item	Description
1	Terminal block	Connect cabling for power and alarm wiring.

The following view applies to SE416, SEC410, SEC418 series.

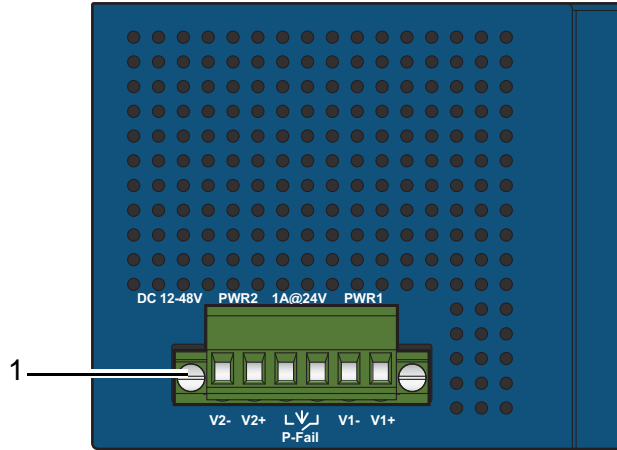

Figure 9: Top View

Table 12: Top View

No.	Item	Description
1	Terminal block	Connect cabling for power and alarm wiring.

Bottom View

The following view applies to SE408 series.

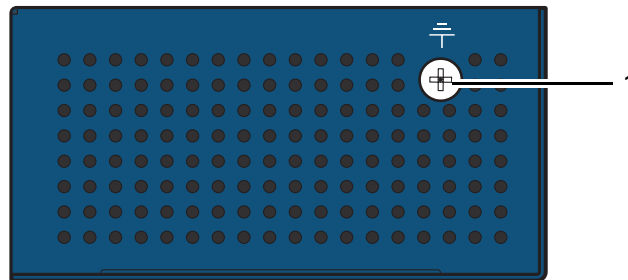

Figure 10: Bottom View

Table 13: Bottom View

No.	Item	Description
1	Ground terminal	Screw terminal used to ground chassis.

The following view applies to SE416, SEC410, SEC418 series.

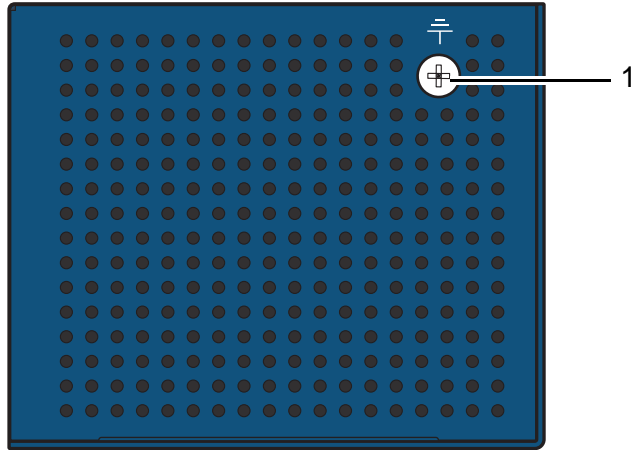

Figure 11: Bottom View

Table 14: Bottom View

No.	Item	Description
1	Ground terminal	Screw terminal used to ground chassis.

SWITCH INSTALLATION

Installation Guidelines

The following guidelines are provided to optimize the device performance. Review the guidelines before installing the device.

- Make sure cabling is away from sources of electrical noise. Radios, power lines, and fluorescent lighting fixtures can interference with the device performance.
- Make sure the cabling is positioned away from equipment that can damage the cables.
- Operating environment is within the ranges listed range, see “Specifications” on page 1.
- Relative humidity around the switch does not exceed 95 percent (noncondensing).
- Altitude at the installation site is not higher than 10,000 feet.
- In 10/100 fixed port devices, the cable length from the switch to connected devices can not exceed 100 meters (328 feet).
- Make sure airflow around the switch and respective vents is unrestricted. Without proper airflow the switch can overheat. To prevent performance degradation and damage to the switch, make sure there is clearance at the top and bottom and around the exhaust vents.

Connecting Hardware

These instructions will explain how to find a proper location for your Modbus Gateways, how to connect to the network, hook up the power cable, and connect to the SE400 Series.

Verifying Switch Operation

Before installing the device in a rack or on a wall, power on the switch to verify that the switch passes the power-on self-test (POST). To connect the cabling to the power source see “Power Supply Installation” on page 20.

At startup (POST), the System LED blinks green, while the remaining LEDs are a solid green. Once the switch passes POST self-test, the System LED turns green. The other LEDs turn off and return to their operating status. If the switch fails POST, the System LED switches to an amber state.

After a successful self-test, power down the switch and disconnect the power cabling.

The switch is now ready for installation on its final location.

Installing the Switch

DIN Rail Mounting

The DIN rail mount option is the quickest installation option. Additionally, it optimizes the use of rail space.

The metal DIN rail kit is secured to the rear of the switch. The device can be mounted onto a standard 35mm (1.37") x 75 mm (3") height DIN rail. The devices can be mounted vertically or horizontally. Refer to the following guidelines for further information.

Note! A corrosion-free mounting rail is advisable.



When installing, make sure to allow for enough space to properly install the cabling.

Installing the DIN-Rail Mounting Kit

1. Insert the top back of the mounting bracket over the DIN rail.
2. Push the bottom of the switch towards the DIN rail until it snaps into place.

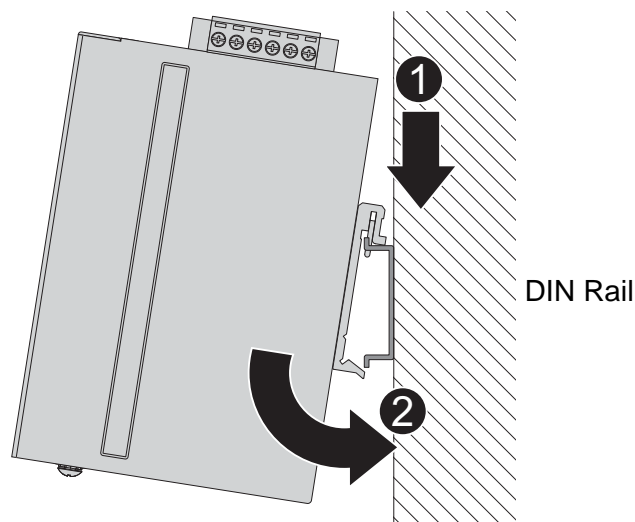

Figure 12: Installing the DIN-Rail Mounting Kit

Removing the DIN-Rail Mounting Kit

1. Push the switch down to free the bottom of the plate from the DIN rail.
2. Rotate the bottom of the device towards you and away from the DIN rail.
3. Once the bottom is clear of the DIN rail, lift the device straight up to unhook it from the DIN rail.

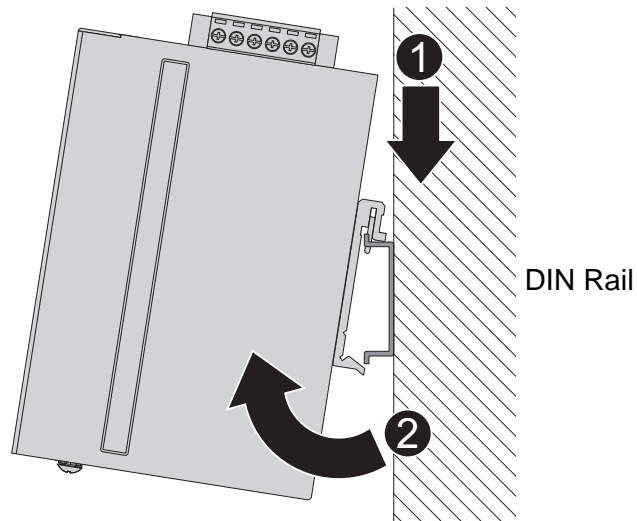

Figure 13: Removing the DIN-Rail

Wall-Mounting

The wall mounting option provides better shock and vibration resistance than the DIN rail vertical mount.

Note! *When installing, make sure to allow for enough space to properly install the cabling.*



Before the device can be mounted on a wall, you will need to remove the DIN rail plate.

1. Rotate the device to the rear side and locate the DIN mounting plate.
2. Remove the screws securing the DIN mounting plate to the rear panel of the switch.
3. Remove the DIN mounting plate. Store the DIN mounting plate and provided screws for later use.
4. Align the wall mounting plates on the rear side. The screw holes on the device and the mounting plates must be aligned, see the following illustration.
5. Secure the wall mount plates with M3 screws, see the following figure.

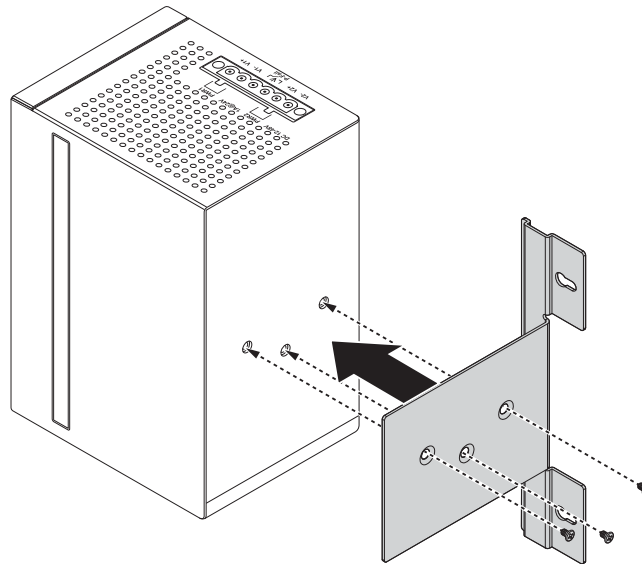

Figure 14: Installing Wall Mount Plates

Once the wall mounting plates are secure on the device, you will need to attach the wall screws (x3).

6. Locate the installation site and place the switch against the wall, making sure it is the final installation location.
7. Use the wall mount plates as a guide to mark the locations of the screw holes.
8. Drill four holes over the four marked locations on the wall, keeping in mind that the holes must accommodate wall sinks in addition to the screws.
9. Insert the wall sinks into the walls.
10. Insert the screws into the wall sinks. Leave a 2 mm gap between the wall and the screw head to allow for wall mount plate insertion.



Figure 15: Securing Wall Mounting Screws

Note!



- Make sure the screws dimensions are suitable for use with the wall mounting plate.
- Do not completely tighten the screws into the wall. A final adjustment may be needed before fully securing the wall mounting plates on the wall.

11. Align the wall mount plate over the screws on the wall.
12. Install the wall mount plate on the screws and slide it forward to lock in place, see the following figure.

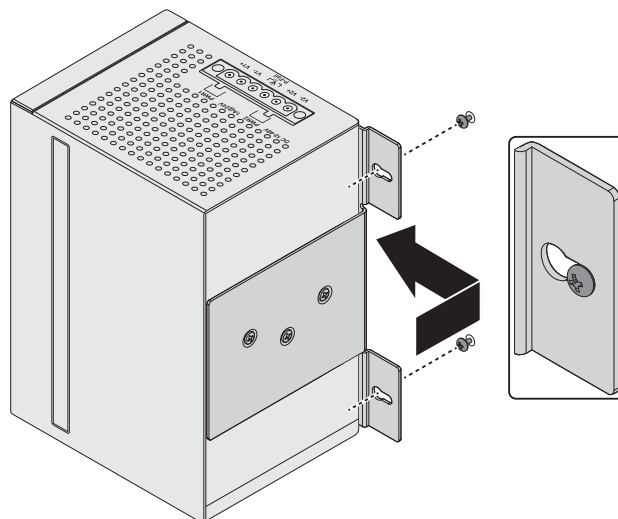

Figure 16: Wall Mount Installation

13. Once the device is installed on the wall, tighten the screws to secure the device.

Installing and Removing SFP Modules

Up to two fiber optic ports are available (dependent on model) for use in the switch. Refer to the technical specifications for details.

The Gigabit Ethernet ports on the switch are 100Base SFP Fiber ports, which require using the 100M or 1G mini-GBIC fiber transceivers to work properly. Advantech provides completed transceiver models for different distance requirement.

The concept behind the LC port and cable is quite straight forward. Suppose that you are connecting devices I and II; contrary to electrical signals, optical signals do not require a circuit in order to transmit data. Consequently, one of the optical lines is used to transmit data from device I to device II, and the other optical line is used transmit data from device II to device I, for full-duplex transmission.

Remember to connect the Tx (transmit) port of device I to the Rx (receive) port of device II, and the Rx (receive) port of device I to the Tx (transmit) port of device II. If you make your own cable, we suggest labeling the two sides of the same line with the same letter (A-to-A and B-to-B, as shown below, or A1-to-A2 and B1-to-B2).

Note! *This is a Class 1 Laser/LED product. To avoid causing serious damage to your eyes, do not stare directly into the Laser Beam.*



Installing SFP Modules

To connect the fiber transceiver and LC cable, use the following guidelines:

1. Remove the dust plug from the fiber optic slot chosen for the SFP transceiver.

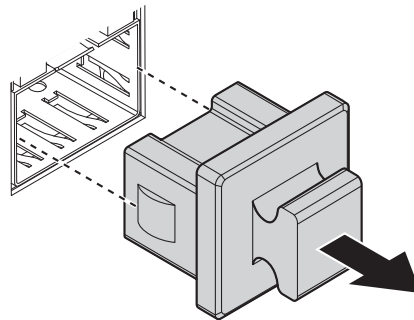

Figure 17: Removing the Dust Plug from an SFP Slot

Note! *Do not remove the dust plug from the SFP slot if you are not installing the transceiver at this time. The dust plug protects hardware from dust contamination.*



2. Position the SFP transceiver with the handle on top, see the following figure.
3. Locate the triangular marking in the slot and align it with the bottom of the transceiver.
4. Insert the SFP transceiver into the slot until it clicks into place.
5. Make sure the module is seated correctly before sliding the module into the slot. A click sounds when it is locked in place.

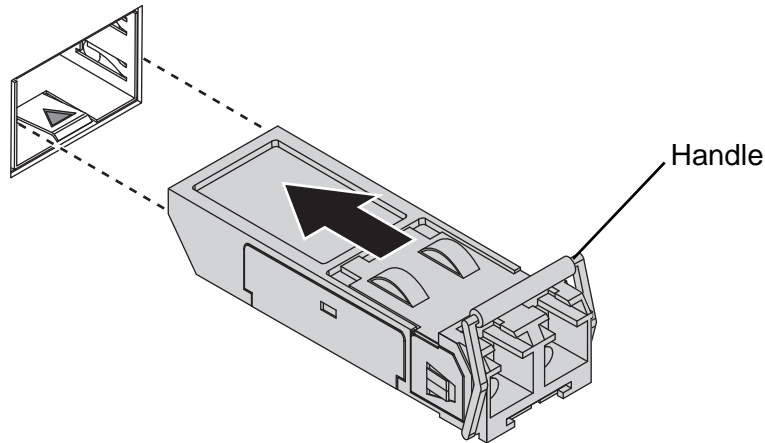

Figure 18: Installing an SFP Transceiver

Note! *If you are attaching fiber optic cables to the transceiver, continue with the following step. Otherwise, repeat the previous steps to install the remaining SFP transceivers in the device.*



6. Remove the protective plug from the SFP transceiver.

Note! *Do not remove the dust plug from the transceiver if you are not installing the fiber optic cable at this time. The dust plug protects hardware from dust contamination.*



7. Insert the fiber cable into the transceiver. The connector snaps into place and locks.

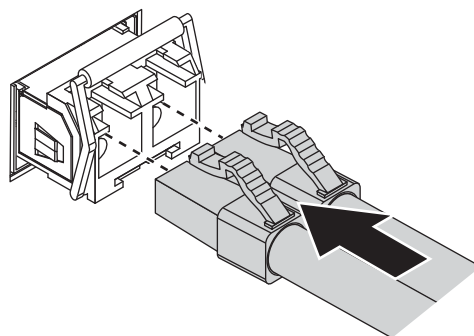

Figure 19: Attaching a Fiber Optic Cable to a Transceiver

8. Repeat the previous procedures to install any additional SFP transceivers in the switch. The fiber port is now set up.

Removing SFP Modules

To disconnect an LC connector, use the following guidelines:

1. Press down and hold the locking clips on the upper side of the optic cable.
2. Pull the optic cable out to release it from the transceiver.

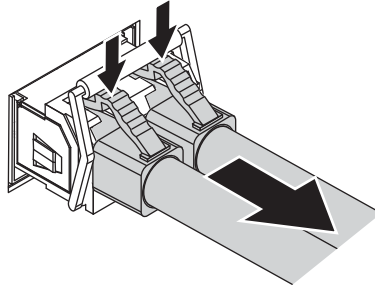

Figure 20: Removing a Fiber Optic Cable to a Transceiver

3. Hold the handle on the transceiver and pull the transceiver out of the slot.

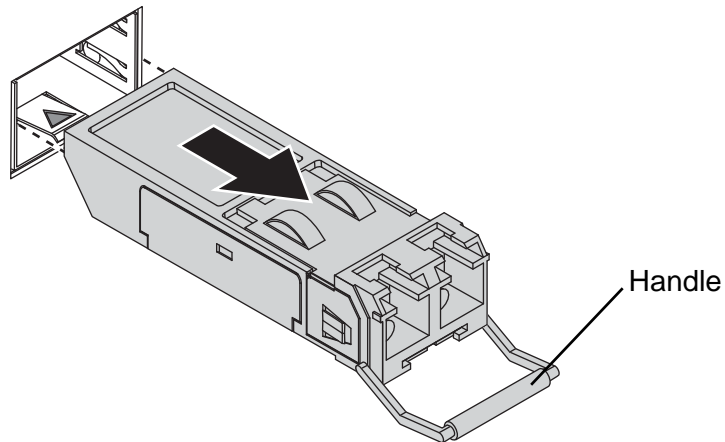

Figure 21: Removing an SFP Transceiver

Note! Replace the dust plug on the slot if you are not installing a transceiver. The dust plug protects hardware from dust contamination.



Connecting the Switch to Ethernet Ports

RJ45 Ethernet Cable Wiring

For RJ45 connectors, data-quality, twisted pair cabling (rated CAT5 or better) is recommended. The connector bodies on the RJ45 Ethernet ports are metallic and connected to the GND terminal. For best performance, use shielded cabling. Shielded cabling may be used to provide further protection.

Table 15: Pin Definition

Straight-thru Cable Wiring		Cross-over Cable Wiring	
Pin 1	Pin 1	Pin 1	Pin 3
Pin 2	Pin 2	Pin 2	Pin 6
Pin 3	Pin 3	Pin 3	Pin 1
Pin 6	Pin 6	Pin 6	Pin 2

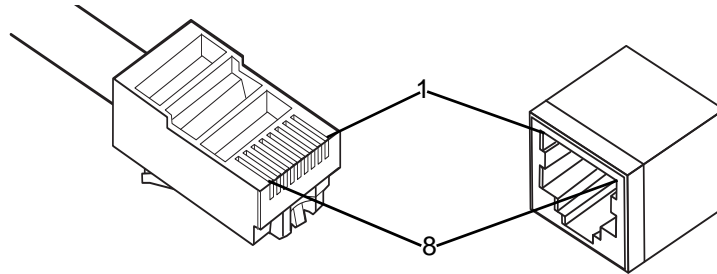

Figure 22: Ethernet Plug & Connector Pin Position

Maximum cable length: 100 meters (328 ft.) for 10/100BaseT.

Power Supply Installation

Overview

Warning! Power down and disconnect the power cord before servicing or wiring the switch.



Caution! Do not disconnect modules or cabling unless the power is first switched off.



The device only supports the voltage outlined in the type plate. Do not use any other power components except those specifically designated for the switch device.

Caution! Disconnect the power cord before installation or cable wiring.



The switches can be powered by using the same DC source used to power other devices. A DC voltage range of 12 to 48 VDC must be applied between the V1+ terminal and the V1- terminal (PW1), see the following illustrations. A Class 2 power supply is required to maintain a UL60950 panel listing. The chassis ground screw terminal should be tied to the panel or chassis ground. A redundant power configuration is supported through a secondary power supply unit to reduce network down time as a result of power loss.

SE400 Series support 12 and 48 VDC. Dual power inputs are supported and allow you to connect a backup power source.

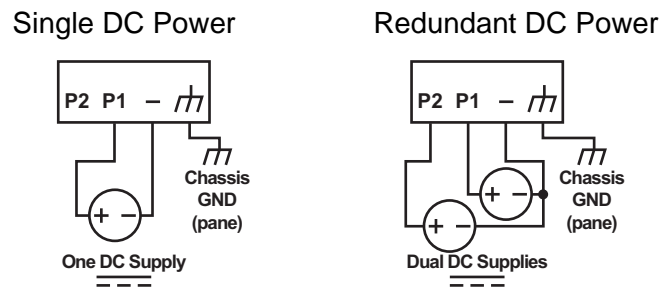

Figure 23: Power Wiring for SE400 Series

Considerations

Take into consideration the following guidelines before wiring the device:

- The Terminal Block (CN1) is suitable for 12-24 AWG (3.31 - 0.205 mm²). Torque value 7 lb-in.
- The cross sectional area of the earthing conductors shall be at least 3.31 mm².
- Calculate the maximum possible current for each power and common wire. Make sure the power draw is within limits of local electrical code regulations.
- For best practices, route wiring for power and devices on separate paths.
- Do not bundle together wiring with similar electrical characteristics.
- Make sure to separate input and output wiring.
- Label all wiring and cabling to the various devices for more effective management and servicing.

Note! *Routing communications and power wiring through the same conduit may cause signal interference. To avoid interference and signal degradation, route power and communications wires through separate conduits.*



Grounding the Device

Caution! Do not disconnect modules or cabling unless the power is first switched off.



The device only supports the voltage outlined in the type plate. Do not use any other power components except those specifically designated for the switch device.

Caution! Before connecting the device properly ground the device. Lack of a proper grounding set up may result in a safety risk and could be hazardous.



Caution! Do not service equipment or cables during periods of lightning activity.



Caution! Do not service any components unless qualified and authorized to do so.



Caution! Do not block air ventilation holes.



Electromagnetic Interference (EMI) affects the transmission performance of a device. By properly grounding the device to earth ground through a drain wire, you can set up the best possible noise immunity and emissions.

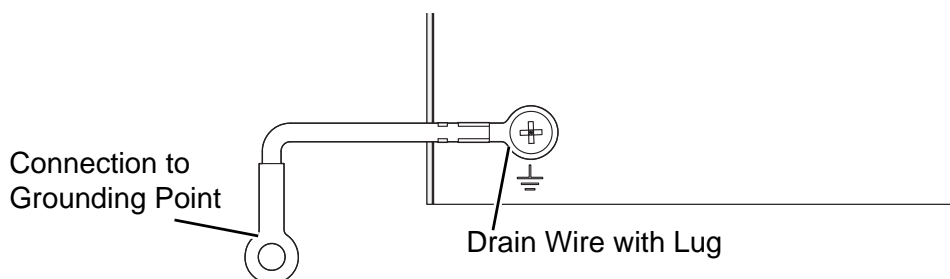

Figure 24: Grounding Connection

By connecting the ground terminal by drain wire to earth ground the switch and chassis can be ground.

Note! Before applying power to the grounded switch, it is advisable to use a volt meter to ensure there is no voltage difference between the power supply's negative output terminal and the grounding point on the switch.



Wiring a Relay Contact

The following section details the wiring of the relay output. The terminal block on the series is wired and then installed onto the terminal receptor located on the series.

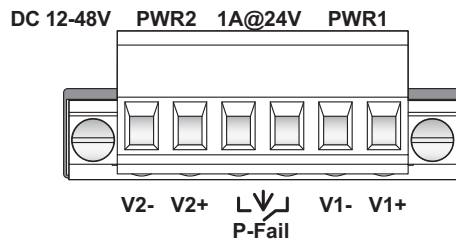

Figure 25: Terminal Receptor: Relay Contact

The terminal receptor includes a total of six pins: two for PWR1, two for PWR2 and two for a fault circuit.

Wiring the Power Inputs

Caution! Do not disconnect modules or cabling unless the power is first switched off. The device only supports the voltage outlined in the type plate. Do not use any other power components except those specifically designated for the switch device.



Warning! Power down and disconnect the power cord before servicing or wiring the switch.



There are two power inputs for normal and redundant power configurations. The power input 2 is used for wiring a redundant power configuration. See the following for terminal block connector views.

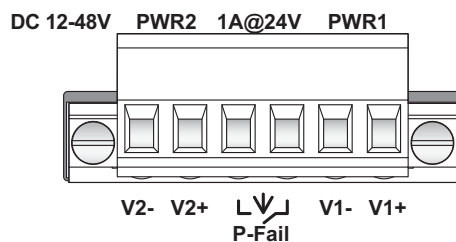

Figure 26: Terminal Receptor: Power Input Contacts

To wire the power inputs:

Make sure the power is not connected to the switch or the power converter before proceeding.

1. Loosen the screws securing terminal block to the terminal block receptor.
2. Remove the terminal block from the switch.

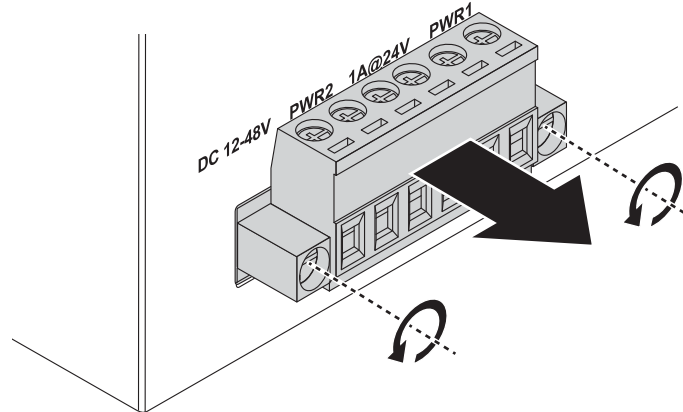

Figure 27: Removing a Terminal Block

3. Insert a small flat-bladed screwdriver in the V1+/V1- wire-clamp screws, and loosen the screws.
4. Insert the negative/positive DC wires into the V+/V- terminals of PW1. If setting up power redundancy, connect PW2 in the same manner.

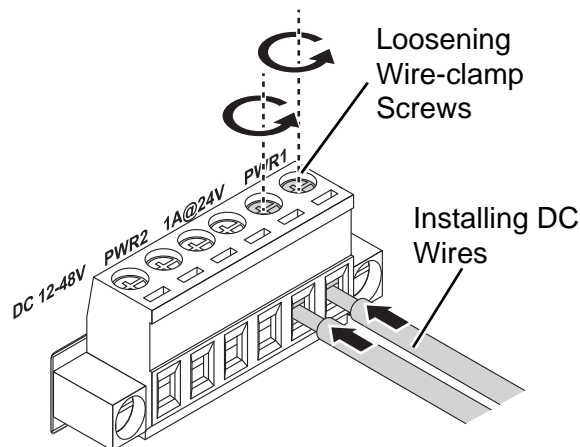

Figure 28: Installing DC Wires in a Terminal Block

5. Tighten the wire-clamp screws to secure the DC wires in place.

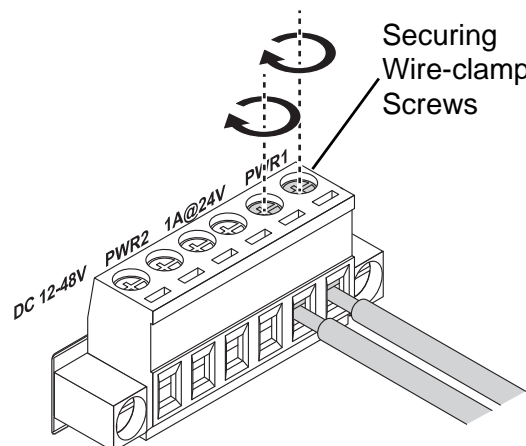

Figure 29: Installing DC Wires in a Terminal Block

6. Align the terminal block over the terminal block receptor on the switch.
7. Insert the terminal block and press it in until it is flush with the terminal block receptor.
8. Tighten the screws on the terminal block to secure it to the terminal block receptor.

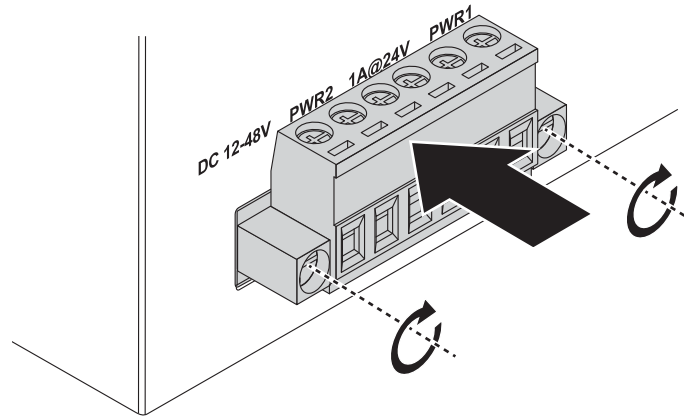

Figure 30: Securing a Terminal Block to a Receptor

If there is no gap between the terminal block and the terminal receptor, the terminal block is seated correctly.

MANAGING SWITCH

First Time set up

Overview

The Industrial Ethernet Managed Switch is a configurable device that facilitates the interconnection of Ethernet devices on an Ethernet network. This includes computers, operator interfaces, I/O, controllers, RTUs, PLCs, other switches/hubs or any device that supports the standard IEEE 802.3 protocol.

This switch has all the capabilities of a store and forward Ethernet switch plus advanced management features such as SNMP, RSTP and port mirroring. This manual details how to configure the various management parameters in this easy to use switch.

SCADA Requirements

To take full advantage of all the features and resources available from the switch, it must be configured for your network.

The switch implements Rapid Spanning Tree Protocol (RSTP) and Simple Network Management Protocol (SNMP) to provide most of the services offered by the switch. Rapid Spanning Tree Protocol allows managed switches to communicate with each other to ensure that there exists only one active route between each pair of network nodes and provides automatic failover to the next available redundant route. A brief explanation of how RSTP works is given in the Spanning Tree section.

The switch is capable of communicating with other SNMP capable devices on the network to exchange management information. This statistical/derived information from the network is saved in the Management Information Base (MIB) of the switch. The MIB is divided into several different information storage groups. These groups will be elaborated in detail in the Management and SNMP information section of this document. The switch implements Internet Group Management Protocol (IGMP) to optimize the flow of multicast traffic on your network.

The switch supports both port-based and tag-based Virtual LANs for flexible integration with VLAN-aware networks with support for VLAN-unaware devices.

Administrative Interface Access

There are several administrative interfaces to the switch:

1. A graphical web interface accessible via the switch's built-in web server, supporting HTTP.

Note! *This is the recommended method for managing the switch.*



2. An SNMP interface can be used to read/write many settings.

Using the Graphical (Web) Interface

The graphical interface is provided via a web server in the switch and can be accessed via a web browser such as Opera, Mozilla, or Internet Explorer.

Note! *JavaScript must be supported and enabled in your browser for the graphical interface to work correctly.*



HTTP is supported for access to the web server. By default, both protocols are enabled. Either or both may be disabled to secure the switch. (See “HTTP” on page 72 in this section.)

To access the graphical interface, enter a URL like HTTP://192.168.1.1 in your browser's address bar. Replace “http” with “https” to use secure http and replace “192.168.1.1” with your switch's IP address if you've changed it from the factory default.

Note! *This manual describes and depicts the web user interface in detail. The terminal interface is not specifically shown but is basically the same.*



Configuring the Switch for Network Access

To control and monitor the switch via the network, it must be configured with basic network settings, including an IP address and subnet mask. Refer to the quick start guide in Section 1 for how to access your switch initially.

To configure the switch for network access, select **System** to reach the System Settings menu. The settings in this menu control the switch's general network configuration.

- DHCP Enabled/Disabled: The switch can automatically obtain an IP address from a server using the Dynamic Host Configuration Protocol (DHCP). This can speed up initial set up, as the network administrator does not have to find an open IP address.
- IP Address and subnet mask configuration: The IP address for the switch can be changed to a user-defined address along with a customized subnet mask to separate subnets.
- NTP Server: The IP address or domain name of an NTP (Network Time Protocol) server from which the switch may retrieve the current time at startup. Please note that using a domain name requires that at least one domain name server be configured.

Configuring the Ethernet Ports

The switch comes with default port settings that should allow you to connect to the Ethernet Ports without any additional configuration. Should there be a need to change the name of the ports, negotiation settings or flow control settings, you can do this in the **Port Configuration** menu. Access this menu by navigating to **L2 Switching > Port Configuration**.

- Port Name: Each port in the managed switch can be identified with a custom name. Specify a name for each port here.
- Admin: Ports can be enabled or disabled in the managed switch. For ports that are disabled, they are virtually non-existent (not visible in terms of switch operation or spanning tree algorithm). Choose to enable or disable a port by selecting Enabled or Disabled, respectively.

- Negotiation: All copper ports and gigabit fiber ports in the managed switch are capable of auto-negotiation such that the fastest bandwidth is selected. Choose to enable auto-negotiation or use fixed settings. 100Mbps Fiber ports are Fixed speed only.
- Speed/Duplex/Flow Control: The managed switch accepts three local area network Ethernet Standards. The first standard, 10BASE-T, runs 10Mbps with twisted pair Ethernet cable between network interfaces. The second local area network standard is 100BASE-T, which runs at 100Mbps over the same twisted pair Ethernet cable. Lastly, there is 100BASE-F, which enables fast Ethernet (100Mbps) over fiber.

These options are available:

- 10h–10 Mbps, Half Duplex
- 10f –10 Mbps, Full Duplex
- 100h–100 Mbps, Half Duplex
- 100f –100 Mbps, Full Duplex

On managed switches with gigabit combination ports, those ports will have two rows, a standard row of check boxes and a row labeled “SFP” with radio buttons. The SFP setting independently sets the speed at which a transceiver will operate if one is plugged in. Otherwise, the switch will use the fixed Ethernet port and the corresponding settings for it.

Web Browser Configuration

The switch has an HTML based user interface embedded in the flash memory. The interface offers an easy to use means to manage basic and advanced switch functions. The interface allows for local or remote switch configuration anywhere on the network.

The interface supports the following:

- Internet Explorer (6.0)
- Chrome
- Firefox

Preparing for Web Configuration

The interface requires the installation and connection of the switch to the existing network. A PC also connected to the network is required to connect to the switch and access the interface through a web browser. The required networking information is provided as follows:

- IP address: 192.168.1.1
- Subnet mask: 255.255.255.0
- Default gateway: 192.168.1.254
- User name: admin
- Password: admin

Log In

To access the login window, connect the device to the network, see “Connecting the Switch to Ethernet Ports” on page 20. Once the switch is installed and connected, power on the switch see the following procedures to log into your switch.

When the switch is first installed, the default network configuration is set to DHCP enabled. You will need to make sure your network environment supports the switch set up before connecting it to the network.

1. Launch your web browser on a computer.
2. In the browser's address bar type in the switch's default IP address (192.168.1.1). The login screen displays.
3. Enter the default user name and password (admin/admin) to log into the management interface. You can change the default password after you have successfully logged in.
4. Click **Login** to enter the management interface.

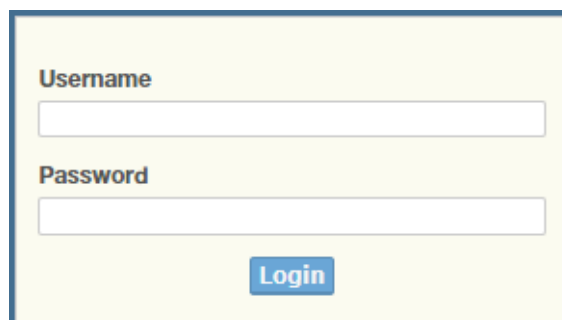

The image shows a web browser login screen with a light yellow background. It contains two text input fields: the top one is labeled 'Username' and the bottom one is labeled 'Password'. Below these fields is a blue button with the text 'Login' in white.

Figure 31: Login Screen

Recommended Practices

One of the easiest things to do to help increase the security posture of the network infrastructure is to implement a policy and standard for secure management. This practice is an easy way to maintain a healthy and secure network.

After you have performed the basic configurations on your switches, the following is a recommendation which is considered best practice policy.

Changing Default Password

In keeping with good management and security practices, it is recommended that you change the default password as soon as the device is functioning and set up correctly. The following details the necessary steps to change the default password.

To change the password:

1. Navigate to **Tools > User Account**.
2. From the User drop-down menu, select the Admin (default) account.
3. In the **User Name** field, enter admin for this account. It is not necessary to change the user name, however, a change in the default settings increases the security settings.
4. In the **Password** field, type in the new password. Re-type the same password in the **Retype Password** field.
5. Click **Apply** to change the current account settings.

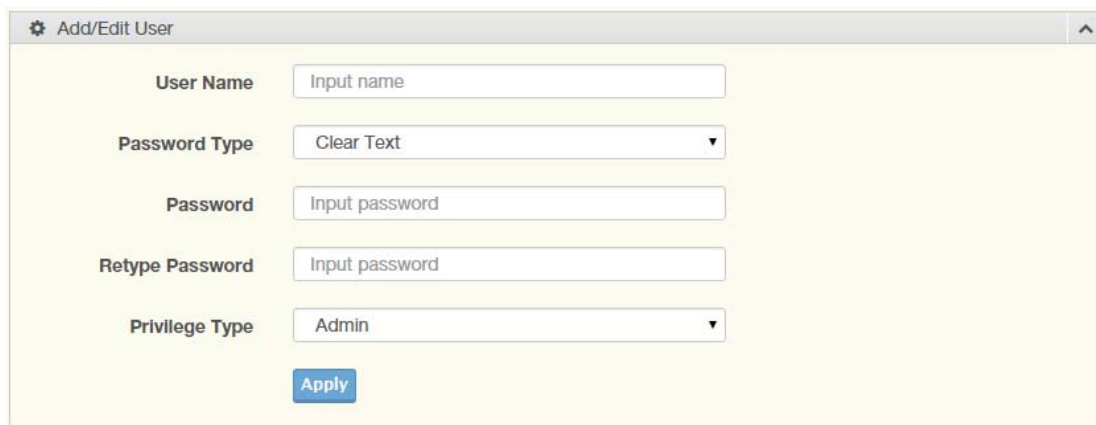

Figure 32: Changing a Default Password

After saving all the desired settings, perform a system save (**Tools > Save Configuration**). The changes are saved.

Monitoring

Device Information

The Device Information menu lists information, such as: System Name, System Location, MAC Address, Firmware version, and more, pertaining to the system. The information is for review only. To modify the device information, see the respective item within the user interface.

To access this page, click **Monitoring > Device Information**.

Information Name	Information Value
System Name	Switch
System Location	Default
System Contact	Default
MAC Address	00:D0:C9:F5:31:0B
IP Address	192.168.1.156
Subnet Mask	255.255.255.0
Gateway	192.168.1.1
Loader Version	1.0.0.48895
Loader Date	Sep 02 2015 - 13:26:50
Firmware Version	1.00.21
Firmware Date	Sep 02 2015 - 13:27:32
System Object ID	1.3.6.1.4.1.10297.202.7000
System Up Time	0 days, 4 hours, 31 mins, 13 secs

Figure 33: Monitoring > Device Information

The following table describes the items in the previous figure.

Table 16: Monitoring > Device Information

Item	Description
System Name	Click Switch to enter the system name: up to 128 alphanumeric characters (default is Switch).
System Location	Click Default to enter the location: up to 256 alphanumeric characters (default is Default).
System Contact	Click Default to enter the contact person: up to 128 alphanumeric characters (default is Default).
MAC Address	Displays the MAC address of the switch.
IP Address	Displays the assigned IP address of the switch.
Subnet Mask	Displays the assigned subnet mask of the switch.
Gateway	Displays the assigned gateway of the switch.
Loader Version	Displays the current loader version of the switch.
Loader Date	Displays the current loader build date of the switch.
Firmware Version	Displays the current firmware version of the switch.
Firmware Date	Displays the current firmware build date of the switch.

Table 16: Monitoring > Device Information (Continued)

Item	Description
System Object ID	Displays the base object ID of the switch.
System Up Time	Displays the time since the last switch reboot.

Logging Message

The Logging Message Filter page allows you to enable the display of logging message filter. To access this page, click **Monitoring > Logging Message**.

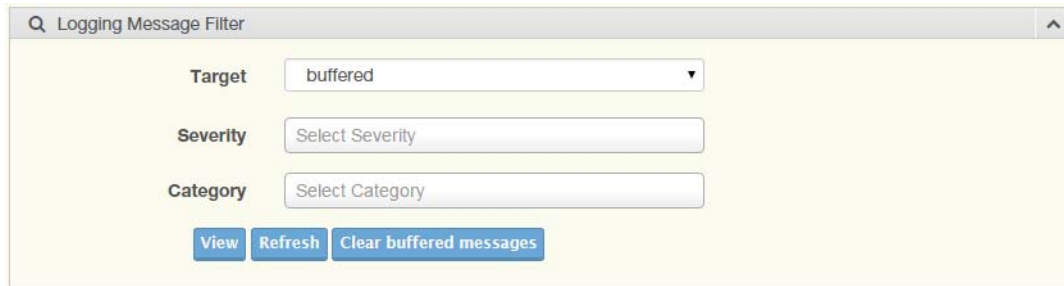

Figure 34: Monitoring > Logging Message

The following table describes the items in the previous figure.

Table 17: Monitoring > Logging Message

Item	Description
Target	Click the drop-down menu to select a target to store the log messages. <ul style="list-style-type: none"> ■ Buffered: Store log messages in RAM. All log messages are cleared after system reboot. ■ File: Store log messages in a file.
Severity	The setting allows you to designate a severity level for the Logging Message Filter function. Click the drop-down menu to select the severity level target setting. The level options are: <ul style="list-style-type: none"> ■ emerg: Indicates system is unusable. It is the highest level of severity. ■ alert: Indicates action must be taken immediately. ■ crit: Indicates critical conditions. ■ error: Indicates error conditions. ■ warning: Indicates warning conditions. ■ notice: Indicates normal but significant conditions. ■ info: Indicates informational messages. ■ debug: Indicates debug-level messages.
Category	Click the drop-down menu to select the category level target setting.
View	Click View to display all Logging Information and Logging Message information.
Refresh	Click Refresh to update the screen.
Clear buffered messages	Click Clear buffered messages to clear the logging buffer history list.

The ensuing table for **Logging Information** table settings are informational only: Target, Severity and Category.

The ensuing table for **Logging Message** table settings are informational only: No., Time Stamp, Category, Severity and Message.

Port Monitoring

Port Network Monitor is a bandwidth and network monitoring tool for the purpose of capturing network traffic and measuring of network throughput. The monitoring functionality includes listing of port statistics as well as port utilization.

Port Statistics

To access this page, click **Monitoring > Port Monitoring > Port Statistics**.



Figure 35: Monitoring > Port Monitoring > Port Statistics

The following table describes the items in the previous figure.

Table 18: Monitoring > Port Monitoring > Port Statistics

Item	Description
Port	Click the drop-down menu to select a port and its captured statistical setting values.
Clear	Click Clear to clear the counter selections.

The ensuing table for **IF MIB Counters** settings are informational only: ifInOctets, ifInUcastPkts, ifInNUcastPkts, ifInDiscards, ifOutOctets, ifOutUcastPkts, ifOutNUcastPkts, ifOutDiscards, ifInMulticastPkts, ifInBroadcastPkts, ifOutMulticastPkts and ifOutBroadcastPkts.

The ensuing table for **Ether-Like MIB Counters** settings are informational only: dot3StatsAlignmentErrors, dot3StatsFCSErrors, dot3StatsSingleCollisionFrames, dot3StatsMultipleCollisionFrames, dot3StatsDeferredTransmissions, dot3StatsLateCollisions, dot3StatsExcessiveCollisions, dot3StatsFrameTooLongs, dot3StatsSymbolErrors, dot3ControllnUnknownOpcodes, dot3InPauseFrames and dot3OutPauseFrames.

Port Utilization

To access this page, click **Monitoring > Port Monitoring > Port Utilization**.

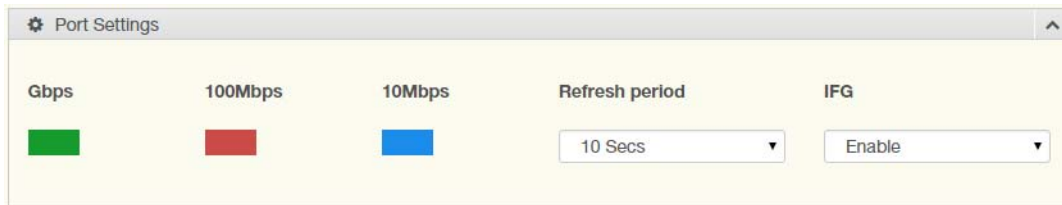

Figure 36: Monitoring > Port Monitoring > Port Utilization

The following table describes the items in the previous figure.

Table 19: Monitoring > Port Monitoring > Port Utilization

Item	Description
Refresh period	Click the drop-down menu to select and designate a period (second intervals) to refresh the information (TX and RX) listings.
IFG	Click the drop-down menu to enable or disable the Interframe Gap (IFG) statistic.

Link Aggregation

The Link Aggregation function provides LAG information for each trunk. It displays membership status, link state and membership type for each port.

To access this page, click **Monitoring > Link Aggregation**.

The ensuing table for **Link Aggregation Group Status** settings are informational only: LAG, Name, Type, Link State, Active Member and Standby Member.

The ensuing table for **LACP Information** settings are informational only: LAG, Port, Partner-SysId, PnKey, AtKey, Sel, Mux, Receiv, PrdTx, AtState and PnState.

LLDP Statistics

The LLDP Statistics page displays the LLDP statistics.

To access this page, click **Monitoring > LLDP Statistics**.

Information Name	Information Value
Insertions	0
Deletions	0
Drops	0
Age Outs	0

Figure 37: Monitoring > LLDP Statistics

The following table describes the items in the previous figure.

Table 20: Monitoring > LLDP Statistics

Item	Description
Clear	Click Clear to reset LLDP Statistics of all the interfaces.
Refresh	Click Refresh to update the data on the screen with the present state of the data in the switch.

The ensuing table for **LLDP Global Statistics** settings are informational only: Insertions, Deletions, Drops and Age Outs.

The ensuing table for **LLDP Port Statistics** settings are informational only: Port, TX Frames (Total), RX Frames (Total, Discarded and Errors), RX TLVs (Discarded and Unrecognized) and RX Ageouts (Total).

IGMP Statistics

The IGMP Statistics function displays statistical package information for IP multicasting. To access this page, click **Monitoring > IGMP Statistics**.

IGMP Statistics	
Statistics Packets	Counter
Total RX	0
Valid RX	0
Invalid RX	0
Other RX	0
Leave RX	0
Report RX	0
General Query RX	0
Special Group Query RX	0
Special Group & Source Query RX	0
Leave TX	0
Report TX	0
General Query TX	0
Special Group Query TX	0
Special Group & Source Query TX	0

Figure 38: Monitoring > IGMP Statistics

The following table describes the items in the previous figure.

Table 21: Monitoring > IGMP Statistics

Item	Description
Clear	Click Clear to refresh IGMP Statistics of all the interfaces.
Refresh	Click Refresh to update the data on the screen with the present state of the data in the switch.

The ensuing table for **IGMP Statistics** settings are informational only: Total RX, Valid RX, Invalid RX, Other RX, Leave RX, Report RX, General Query RX, Special Group Query RX, Special Group & Source Query RX, Leave TX, Report TX, General Query TX, Special Group Query TX and Special Group & Source Query TX.

System

IP Settings

The IP Settings menu allows you to select a static or DHCP network configuration. The Static displays the configurable settings for the static option.

To access this page, click **System > IP Settings**.

Figure 39: System > IP Settings

The following table describes the items in the previous figure.

Table 22: System > IP Settings

Item	Description
Mode	Click the radio button to select the IP Address Setting mode: Static, DHCP, or BOOTP.
IP Address	Enter a value to specify the IP address of the interface. The default is 192.168.1.1.
Subnet Mask	Enter a value to specify the IP subnet mask for the interface. The default is 255.255.255.0.
Gateway	Enter a value to specify the default gateway for the interface. The default is 192.168.1.254.
DNS Server 1	Enter a value to specify the DNS server 1 for the interface. The default is 168.95.1.1.
DNS Server 2	Enter a value to specify the DNS server 2 for the interface. The default is 168.95.192.1.
Apply	Click Apply to save the values and update the screen.

The ensuing table for **IP Address Information** settings are informational only: DHCP State, BOOTP State, Static IP Address, Static Subnet Mask, Static Gateway, Static DNS Server 1 and Static DNS Server 2.

DHCP Client Option 82

The DHCP Client Option 82 configurable Circuit ID and Remote ID feature enhances validation security by allowing you to select naming choices suboptions. You can select a switch-configured hostname or specify an ASCII test string for the remote ID. You can also configure an ASCII text string to override the circuit ID.

To access this page, click **System > DHCP Client Option 82**.

Figure 40: System > DHCP Client Option 82

The following table describes the items in the previous figure.

Table 23: System > DHCP Client Option 82

Item	Description
Mode	Click the radio button to enable or disable the DHCP Client Option 82 mode.
Circuit ID Format	Click the drop-down menu to set the ID format: String, Hex, User Definition.
Circuit ID String	Enter the string ID of the corresponding class.
Circuit ID Hex	Enter the hex string of the corresponding class.
Circuit ID User-Define	Enter the user definition of the corresponding class.
Remote ID Format	Click the drop-down menu to set the Remote ID format: String, Hex, User Definition.
Remote ID String	Enter the remote string ID of the corresponding class.
Remote ID Hex	Enter the remote hex string of the corresponding class.
Remote ID User-Define	Enter the remote user definition of the corresponding class.
Apply	Click Apply to save the values and update the screen.

The ensuing table for **DHCP Client Option 82 Information** table settings are informational only: Status, Circuit ID Format, Circuit ID String, Circuit ID Hex, Circuit ID User-Define, Remote ID Format, Remote ID String, Remote ID Hex and Remote ID User-Define.

DHCP Auto Provision

The DHCP Auto Provision feature allows you to load configurations using a server with DHCP options. Through the remote connection, the switch obtains information from a configuration file available through the TFTP server.

To access this page, click **System > DHCP Auto Provision**.



Figure 41: System > DHCP Auto Provision

The following table describes the items in the previous figure.

Table 24: System > DHCP Auto Provision

Item	Description
Status	Select the radio button to enable or disable the DHCP Auto Provisioning Setting.
Apply	Click Apply to save the values and update the screen.

The ensuing table for **DHCP Auto Provision Information** settings are informational only: Status.

IPv6 Settings

To access this page, click **System > IPv6 Settings**.

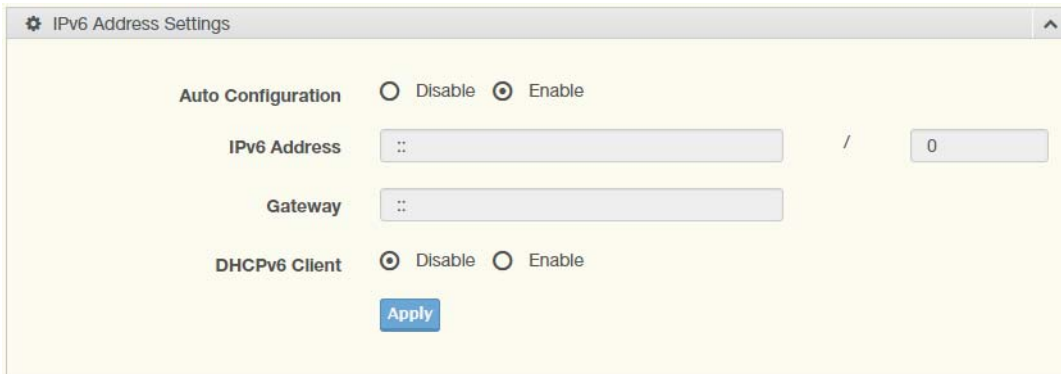

Figure 42: System > IPv6 Settings

The following table describes the items in the previous figure.

Table 25: System > IPv6 Settings

Item	Description
Auto Configuration	Select the radio button to enable or disable the IPv6.
IPv6 Address	Enter the IPv6 address for the system.
Gateway	Enter the gateway address for the system.
DHCPv6 Client	Enter the DHCPv6 address for the system.
Apply	Click Apply to save the values and update the screen.

The ensuing table for **IPv6 Information** settings are informational only: Auto Configuration, IPv6 In Use Address, IPv6 In Use Router, IPv6 Static Address, IPv6 Static Router and DHCPv6 Client.

Management VLAN

By default the VLAN is the management VLAN providing communication with the switch management interface.

To access this page, click **System > Management VLAN**.



Figure 43: System > Management VLAN

The following table describes the items in the previous figure.

Table 26: System > Management VLAN

Item	Description
Management VLAN	Click the drop-down menu to select a defined VLAN.
Apply	Click Apply to save the values and update the screen.

The ensuing table for **Management VLAN State** are informational only: Management VLAN.

System Time

To access this page, click **System > System Time**.

Figure 44: System > System Time

The following table describes the items in the previous figure.

Table 27: System > System Time

Item	Description
Enable SNTP	Click the radio button to enable or disable the SNTP.
SNTP/NTP Server Address	Enter the address of the SNTP server. This is a text string of up to 64 characters containing the encoded unicast IP address or hostname of a SNTP server. Unicast SNTP requests will be sent to this address. If this address is a DNS hostname, then that hostname should be resolved into an IP address each time a SNTP request is sent to it.
SNTP Port	Enter the port on the server to which SNTP requests are to be sent. Allowed range is 1 to 65535 (default: 123).
Manual Time	Click the drop-down menus to set local date and time of the system.
Time Zone	Click the drop-down menu to select a system time zone.

Table 27: System > System Time (Continued)

Item	Description
Daylight Saving Time	Click the drop-down menu to enable or disable the daylight saving time settings.
Daylight Saving Time Offset	Enter the offsetting variable in seconds to adjust for daylight saving time.
Recurring From	Click the drop-down menu to designate the start date and time for daylight saving time.
Recurring To	Click the drop-down menu to designate the end date and time for daylight saving time.
Non-Recurring From	Click the drop-down menu to designate a start date and time for a non-recurring daylight saving time event.
Non-Recurring To	Click the drop-down menu to designate the end date and time for a non-recurring daylight saving time event.
Apply	Click Apply to save the values and update the screen.

The ensuing table for **System Time Information** settings are informational only: Current Date/Time, SNTP, SNTP Server Address, SNTP Server Port, Time zone, Daylight Saving Time, Daylight Saving Time Offset, From and To.

L2 Switching

Port Configuration

Port Configuration describes how to use the user interface to configure LAN ports on the switch.

To access this page, click **L2 Switching > Port Configuration**.

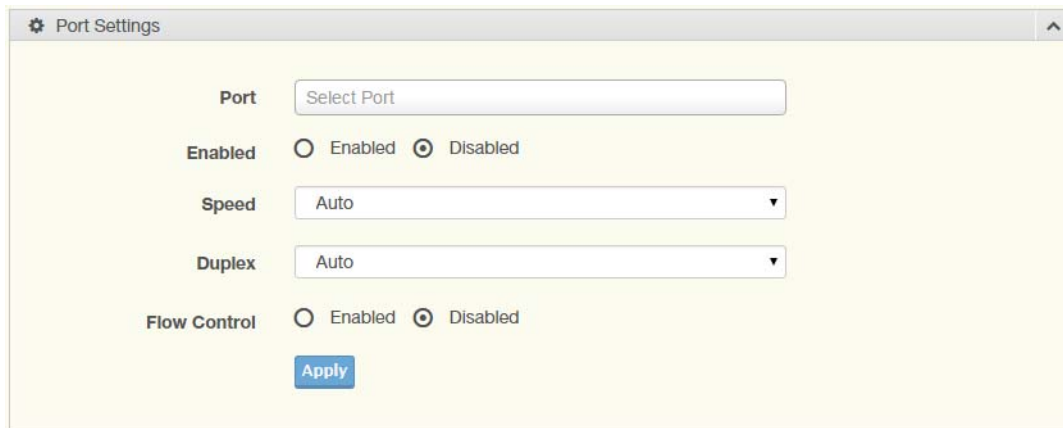

Figure 45: L2 Switching > Port Configuration

The following table describes the items in the previous figure.

Table 28: L2 Switching > Port Configuration

Item	Description
Port	Click the drop-down menu to select the port for the L2 Switch setting.
Enabled	Click the radio-button to enable or disable the Port Setting function.
Speed	Click the drop-down menu to select the port speed: Auto, Auto-10M, Auto-100M, Auto-10/100M, 10M or 100M.
Duplex	Click the drop-down menu to select the duplex setting: Half or Full.

Table 28: L2 Switching > Port Configuration (Continued)

Item	Description
Flow Control	Click the radio button to enable or disable the flow control function.
Apply	Click Apply to save the values and update the screen.

The ensuing table for **Port Status** settings are informational only: Port, **Edit** (click to enter description), Enable State, Link Status, Speed, Duplex, FlowCtrl Config and FlowCtrl Status.

Port Mirror

Port mirroring function allows the sending of a copy of network packets seen on one switch port to a network monitoring connection on another switch port. Port mirroring can be used to analyze and debug data or diagnose errors on a network or to mirror either inbound or outbound traffic (or both).

There are no preset values in the Port Mirror. The displayed values do not represent the actual setting values.

To access this page, click **L2 Switching > Port Mirror**.

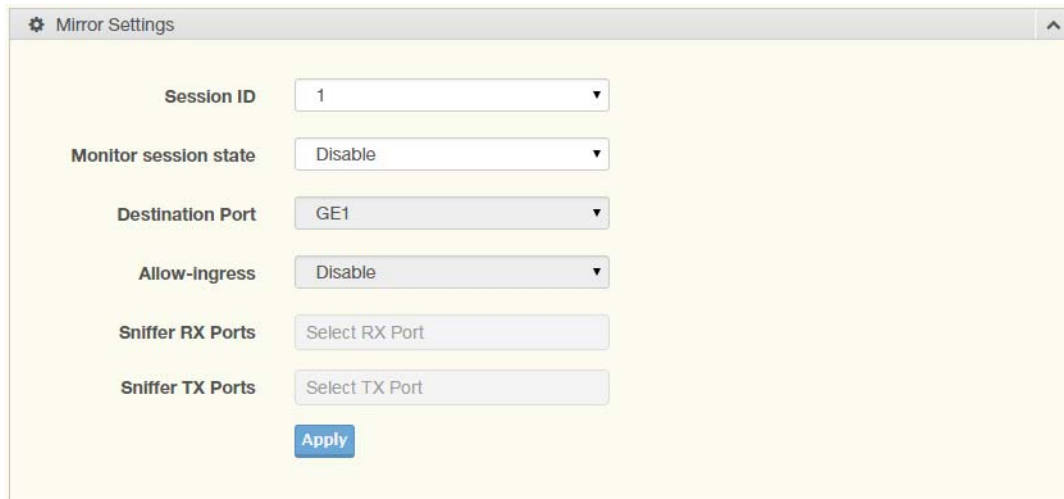

Figure 46: L2 Switching > Port Mirror

The following table describes the items in the previous figure.

Table 29: L2 Switching > Port Mirror

Item	Description
Session ID	Click the drop-down menu to select a port mirroring session from the list. The number of sessions allowed is platform specific.
Monitor session state	Click the drop-down menu to enable or disable the session mode for a selected session ID.
Destination Port	Click the drop-down menu to select the destination port and receive all the traffic from configured mirrored port(s).
Allow-ingress	Click the drop-down menu to enable or disable the Allow-ingress function.
Sniffer RX Ports	Enter the variable to define the RX port.
Sniffer TX Ports	Enter the variable to define the TX port.
Apply	Click Apply to save the values and update the screen.

The ensuing table for **Mirror Status** settings are informational only: Session ID, Destination Port, Ingress State, Source TX Port and Source RX Port.

Link Aggregation

Link Aggregation is a method for combining multiple network connections in parallel in order to increase throughput beyond the capability of a single connection, and to provide redundancy in case one of the links should fail.

Load Balance

The Load Balancing page allows you to select between a MAC Address or IP/MAC Address algorithm for the even distribution of IP traffic across two or more links.

To access this page, click **L2 Switching > Link Aggregation > Load Balance**.



Figure 47: L2 Switching > Link Aggregation > Load Balance

The following table describes the items in the previous figure.

Table 30: L2 Switching > Link Aggregation > Load Balance

Item	Description
Load Balance Algorithm	Select the radio button to select the Load Balance Setting: MAC Address or IP/MAC Address.
Apply	Click Apply to save the values and update the screen.

The ensuing table for **Load Balance Information** settings are informational only: Load Balance Algorithm.

LAG Management

Link aggregation is also known as trunking. It is a feature available on the Ethernet gateway and is used with Layer 2 Bridging. Link aggregation allows for the logical merging of multiple ports into a single link.

To access this page, click **L2 Switching > Link Aggregation > LAG Management**.



Figure 48: L2 Switching > Link Aggregation > LAG Management

The following table describes the items in the previous figure.

Table 31: L2 Switching > Link Aggregation > LAG Management

Item	Description
LAG	Click the drop-down menu to select the designated trunk group: Trunk 1~8.
Name	Enter an entry to specify the LAG name.

Table 31: L2 Switching > Link Aggregation > LAG Management

Item	Description
Type	Click the radio button to specify the type mode: Static or LACP.
Ports	Click the drop-down menu to select designated ports: Port1-10.
Apply	Click Apply to save the values and update the screen.

The ensuing table for **LAG Management Information** settings are informational only: LAG, Name, Type, Link State, Active Member, Standby Member, **Edit** (click to modify the settings) and **Clear** (click to load default settings).

LAG Port Settings

The LAG Port Settings page allows you to enable or disable, set LAG status, speed and flow control functions.

In this example we will configure a LAG between the following switches:

To access this page, click **L2 Switching > Link Aggregation > LAG Port Settings**.

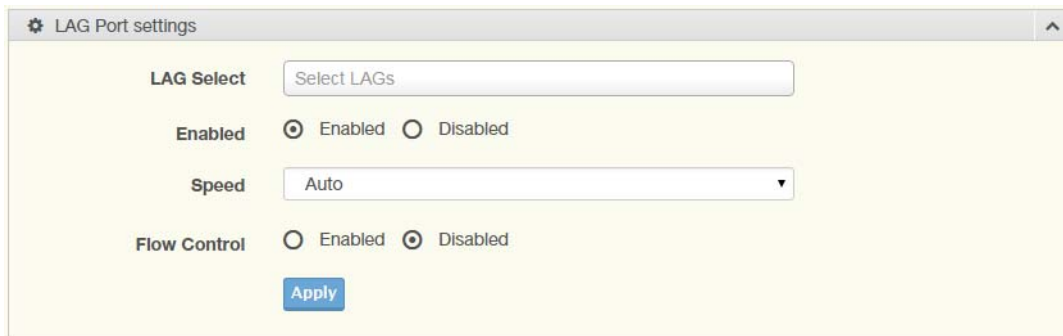

Figure 49: L2 Switching > Link Aggregation > LAG Port Settings

The following table describes the items in the previous figure.

Table 32: L2 Switching > Link Aggregation > LAG Port Settings

Item	Description
LAG Select	Click the drop-down menu to select a predefined LAG trunk definition: LAG 1-8.
Enabled	Click the radio button to enable or disable the LAG Port.
Speed	Click the drop-down menu to select the port speed: Auto, Auto-10M, Auto-100M, Auto-10/100M, 10M or 100M.
Flow Control	Click the radio button to enable or disable the Flow Control for the LAG Port.
Apply	Click Apply to save the values and update the screen.

The ensuing table for **LAG Port Status** settings are informational only: LAG, Description, Port Type, Enable State, Link Status, Speed, Duplex, FlowCtrl Config and FlowCtrl Status.

LACP Priority Settings

The LACP Priority Settings page allows you to configure the system priority for LACP. To access this page, click **L2 Switching > Link Aggregation > LACP Priority Settings**.



Figure 50: L2 Switching > Link Aggregation > LACP Priority Settings

The following table describes the items in the previous figure.

Table 33: L2 Switching > Link Aggregation > LACP Priority Settings

Item	Description
System Priority	Enter the value (1-65535) to designate the LACP system priority.
Apply	Click Apply to save the values and update the screen.

The ensuing table for **LACP Information** settings are informational only: System Priority.

LACP Port Settings

Link Aggregation Control Protocol (LACP) provides a method to control the bundling of several physical ports together to form a single logical channel. By configuring the LACP function, the switch can negotiate an automatic bundling of links by sending LACP packets to the peer device (also implementing LACP).

To access this page, click **L2 Switching > Link Aggregation > LACP Port Settings**.

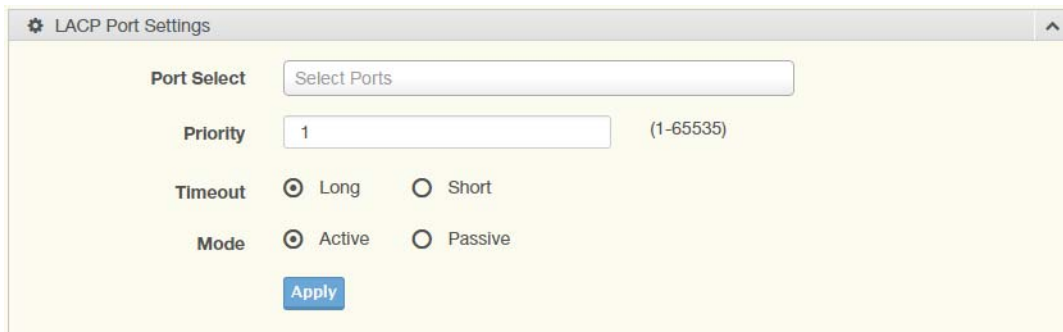

Figure 51: L2 Switching > Link Aggregation > LACP Port Settings

The following table describes the items in the previous figure.

Table 34: L2 Switching > Link Aggregation > LACP Port Settings

Item	Description
Port Select	Select a port for the LACP Port Settings. The listed available settings are: Port1-10. However, the available settings are dependent on the connected LACP device and may not be listed as displayed in the current figure.
Priority	Enter a variable (1 to 65535) to assign a priority to the defined port selection.
Timeout	Click the radio button to select a long or short timeout period.
Mode	Click the radio button to select the setting mode: Active or Passive. <ul style="list-style-type: none"> ■ Active: Enables LACP unconditionally. ■ Passive: Enables LACP only when an LACP device is detected (default state).
Apply	Click Apply to save the values and update the screen.

The ensuing table for **LACP Port Information** settings are informational only: Port Name, Priority, Timeout and Mode.

802.1Q VLAN

The 802.1Q VLAN feature allows for a single VLAN to support multiple VLANs. With the 802.1Q feature you can preserve VLAN IDs and segregate different VLAN traffic.

The 802.1Q VLAN tag feature encapsulates the 802.1Q VLAN tagging within another 802.1Q VLAN tag. The outer tag is assigned following the AP group, while the inner VLAN ID is assigned dynamically by the AAA server.

VLAN Management

The management of VLANs is available through the VLAN Settings page. Through this page you can add or delete VLAN listings and add a prefix name to an added entry.

To access this page, click **L2 Switching > 802.1Q VLAN > VLAN Management**.

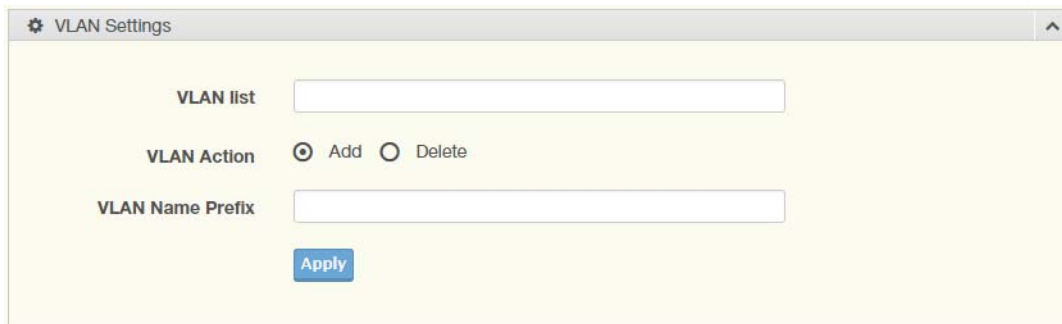

Figure 52: L2 Switching > 802.1Q VLAN > VLAN Management

The following table describes the items in the previous figure.

Table 35: L2 Switching > 802.1Q VLAN > VLAN Management

Item	Description
VLAN list	Enter the name of the VLAN entry to set up.
VLAN Action	Click the radio button to add or delete the VLAN entry shown in the previous field.
VLAN Name Prefix	Enter the prefix to be used by the VLAN list entry in the previous field.
Apply	Click Apply to save the values and update the screen.

The ensuing table for **VLAN Table** settings are informational only: VLAN ID, VLAN Name, VLAN Type and **Edit** (click to enter VLAN name).

PVID Settings

The PVID Settings page allows you to designate a PVID for a selected port, define the accepted type and enable/disable the ingress filtering.

To access this page, click **L2 Switching > 802.1Q VLAN > PVID Settings**.

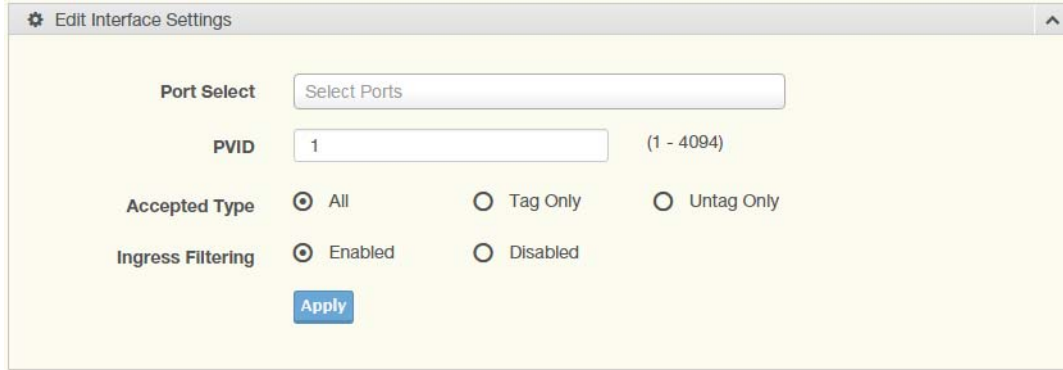

Figure 53: L2 Switching > 802.1Q VLAN > PVID Settings

The following table describes the items in the previous figure.

Table 36: L2 Switching > 802.1Q VLAN > PVID Settings

Item	Description
Port Select	Click the drop-down menu to select a port and edit its settings: Port1-10, or Trunk1 - Trunk8.
PVID	Enter the VLAN ID you want assigned to untagged or priority tagged frames received on this port. The value ranges 1 to 4094. The default is 1.
Accepted Type	Click the radio button to specify which frames to forward. Tag Only discards any untagged or priority tagged frames. Untag Only discards any tagged frames. All accepts all untagged and tagged frames. Whichever you select, VLAN tagged frames are forwarded in accordance with the IEEE 802.1Q VLAN standard. The default is All.
Ingress Filtering	Click the radio button to specify how you want the port to handle tagged frames. If you enable Ingress Filtering, a tagged frame will be discarded if this port is not a member of the VLAN identified by the VLAN ID in the tag. If you select Disabled, all tagged frames will be accepted. The default is Disabled.
Apply	Click Apply to save the values and update the screen.

The ensuing table for **Port VLAN Status** settings are informational only: Port, Interface VLAN Mode, PVID, Accept Frame Type and Ingress Filtering.

Port to VLAN

The Port to VLAN page allows you to add a port to a VLAN and select the related parameters. To access this page, click **L2 Switching > 802.1Q VLAN > Port to VLAN**.



Figure 54: L2 Switching > 802.1Q VLAN > Port to VLAN

The following table describes the items in the previous figure.

Table 37: L2 Switching > 802.1Q VLAN > Port to VLAN

Item	Description
Port	Displays the assigned port to the entry.
Interface VLAN Mode	Displays the assigned mode to the listed VLAN port. <ul style="list-style-type: none"> ■ Hybrid: Port hybrid model. ■ Access: Port hybrid model. ■ Trunk: Port hybrid model. ■ Tunnel: Port hybrid model.
Membership	Displays the assigned membership status of the port entry, options include: Forbidden, Excluded Tagged or Untagged.
Apply	Click Apply to save the values and update the screen.

Port-VLAN Mapping

To access this page, click **L2 Switching > 802.1Q VLAN > Port-VLAN Mapping**.

The ensuing table for **Port-VLAN Mapping Table** settings are informational only: Port, Mode, Administrative VLANs and Operational VLANs.

GARP

The Generic Attribute Registration Protocol (GARP) is a local area network (LAN) protocol. The protocol defines procedures for the registration and de-registration of attributes (network identifiers or addresses) by end stations and switches with each other.

GARP Settings

To access this page, click **L2 Switching > GARP > GARP Settings**.

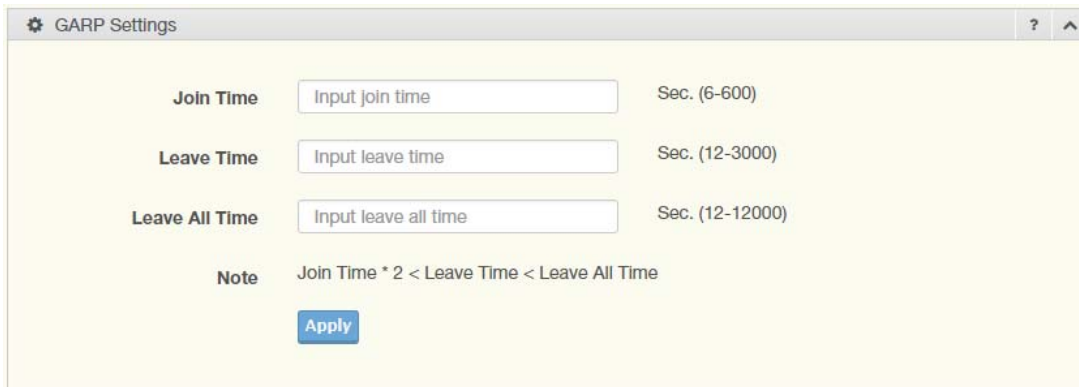

Figure 55: L2 Switching > GARP > GARP Settings

The following table describes the items in the previous figure.

Table 38: L2 Switching > GARP > GARP Settings

Item	Description
Join Time	Enter a value to specify the time between the transmission of GARP PDUs registering (or re-registering) membership for a VLAN or multicast group in centiseconds. Enter a number between 6 and 600. An instance of this timer exists for each GARP participant for each port.
Leave Time	Enter a value to specify the time to wait after receiving an unregister request for a VLAN or multicast group before deleting the associated entry, in centiseconds. This allows time for another station to assert registration for the same attribute in order to maintain uninterrupted service. Enter a number between 12 and 3000. An instance of this timer exists for each GARP participant for each port.
Leave All Time	Enter a value to specify the Leave All Time controls how frequently Leave All PDUs are generated. A LeaveAll PDU indicates that all registrations will shortly be deregistered. Participants will need to rejoin in order to maintain registration. The Leave All Period Timer is set to a random value in the range of LeaveAllTime to 1.5*LeaveAllTime. The timer is specified in centiseconds. Enter a number between 12 and 12000. An instance of this timer exists for each GARP participant for each port.
Apply	Click Apply to save the values and update the screen.

The ensuing table for **GARP Information** settings are informational only: Join Time, Leave Time and Leave All Time.

GVRP Settings

The GVRP Settings page allows you to enable or disable the GVRP (GARP VLAN Registration Protocol or Generic VLAN Registration Protocol) protocol which facilitates control of virtual local area networks (VLANs) within a larger network.

To access this page, click **L2 Switching > GARP > GVRP Settings**.



Figure 56: L2 Switching > GARP > GVRP Settings

The following table describes the items in the previous figure.

Table 39: L2 Switching > GARP > GVRP Settings

Item	Description
Status	Click to enable or disable the GARP VLAN Registration Protocol administrative mode for the switch. The factory default is Disable.
Apply	Click Apply to save the values and update the screen.

The ensuing table for **GVRP Information** settings are informational only: GVRP.

802.3az EEE

The 802.3az Energy Efficient Ethernet (EEE) innovative green feature reduces energy consumption through intelligent functionality:

- Traffic detection — Energy Efficient Ethernet (EEE) compliance
- Inactive link detection

Inactive link detection function automatically reduces power usage when inactive links or devices are detected.

To access this page, click **L2 Switching > 802.3az EEE**.



Figure 57: L2 Switching > 802.3az EEE

The following table describes the items in the previous figure.

Table 40: L2 Switching > 802.3az EEE

Item	Description
Port Select	Enter the port to set up the EEE function.
State	Click Enabled or Disabled to set the state mode of the port select setting.
Apply	Click Apply to save the values and update the screen.

The ensuing table for **EEE Enable Status** settings are informational only: Port and EEE State.

Multicast

SCADA Requirements

Multicast forwarding allows a single packet to be forwarded to multiple destinations. The service is based on L2 switch receiving a single packet addressed to a specific Multicast address. Multicast forwarding creates copies of the packet, and transmits the packets to the relevant ports.

Multicast Filtering

The Multicast Filtering page allows for the definition of action settings when an unknown multicast request is received. The options include: Drop, Flood, or Router Port.

To access this page, click **L2 Switching > Multicast > Multicast Filtering**.

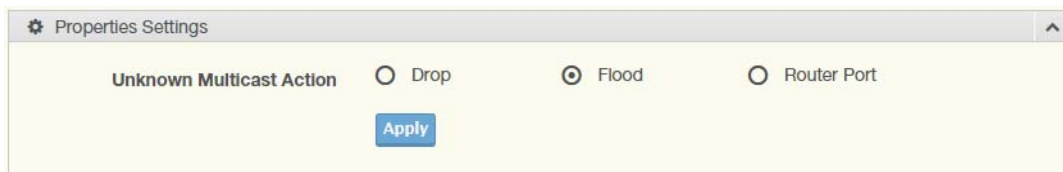

Figure 58: L2 Switching > Multicast > Multicast Filtering

The following table describes the items in the previous figure.

Table 41: L2 Switching > Multicast > Multicast Filtering

Item	Description
Unknown Multicast Action	Select the configuration protocol: Drop, Flood, or Router Port, to apply for any unknown multicast event.
Apply	Click Apply to save the values and update the screen.

The ensuing table for **Properties Information** settings are informational only: Unknown Multicast Action.

IGMP Snooping

IGMP Snooping is defined as the process of listening to Internet Group Management Protocol (IGMP) network traffic. IGMP Snooping allows a network switch to listen in on the IGMP conversation between hosts and routers and maintain a map of which links need which IP multi-cast streams. Multicasts can be filtered from the links which do not need them in turn controlling which ports receive specific multicast traffic.

IGMP Settings

To access this page, click **L2 Switching > Multicast > IGMP Snooping > IGMP Settings**.

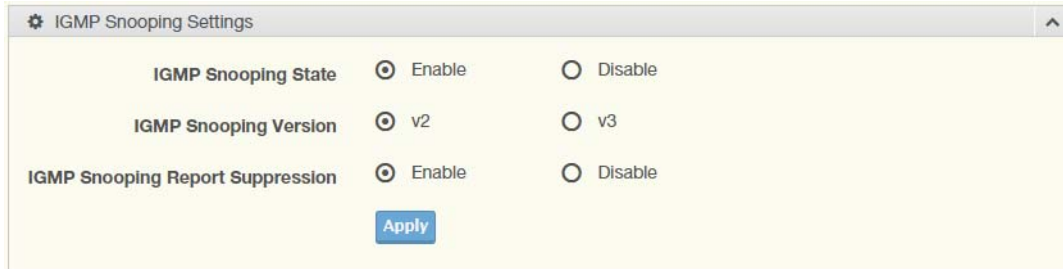

Figure 59: L2 Switching > Multicast > IGMP Snooping > IGMP Settings

The following table describes the items in the previous figure.

Table 42: L2 Switching > Multicast > IGMP Snooping > IGMP Settings

Item	Description
IGMP Snooping State	Select Enable or Disable to designate the IGMP Snooping State.
IGMP Snooping Version	Select designate the IGMP Snooping Version: V2 or V3.
IGMP Snooping Report Suppression	Select Enable or Disable to set up the report suppression for IGMP Snooping.
Apply	Click Apply to save the values and update the screen.

The ensuing table for **IGMP Snooping Information** settings are informational only: IGMP Snooping State, IGMP Snooping Version and IGMP Snooping V2 Report Suppression.

The ensuing table for **IGMP Snooping Table** settings are informational only: Entry No., VLAN ID, IGMP Snooping Operation State, Router Ports Auto Learn, Query Robustness, Query Interval (sec.), Query Max Response Interval (sec.), Last Member Query count, Last Member Query Interval (sec), Immediate Leave and **Edit** (click to modify the settings).

IGMP Querier

IGMP Querier allows snooping to function by creating the tables for snooping. General queries must be unconditionally forwarded by all switches involved in IGMP snooping.

To access this page, click **L2 Switching > Multicast > IGMP Snooping > IGMP Querier**.

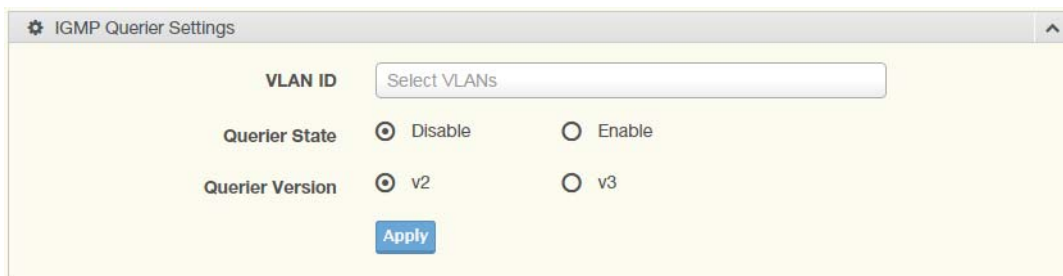

Figure 60: L2 Switching > Multicast > IGMP Snooping > IGMP Querier

The following table describes the items in the previous figure.

Table 43: L2 Switching > Multicast > IGMP Snooping > IGMP Querier

Item	Description
VLAN ID	Select the VLAN ID to define the local IGMP querier.
Querier State	Select Disable or Enable to configure the VLAN ID (IGMP Querier).
Querier Version	Select the querier version (V2 or V3) designated to the selected VLAN ID.
Apply	Click Apply to save the values and update the screen.

The ensuing table for **IGMP Querier Status** settings are informational only: VLAN ID, Querier State, Querier Status, Querier Version and Querier IP.

IGMP Static Groups

To access this page, click **L2 Switching > Multicast > IGMP Snooping > IGMP Static Groups**.

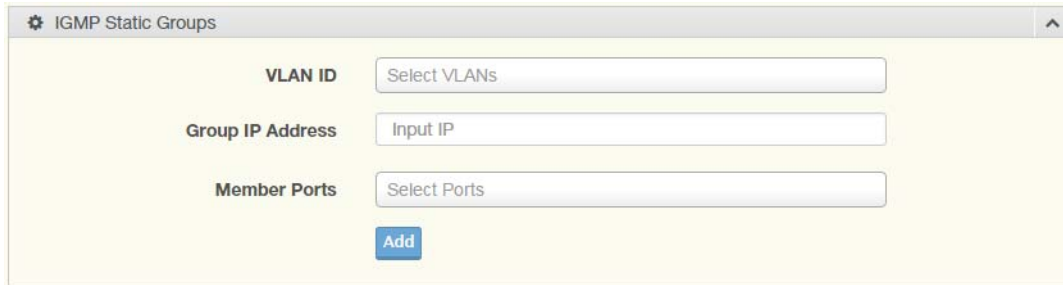

Figure 61: L2 Switching > Multicast > IGMP Snooping > IGMP Static Groups

The following table describes the items in the previous figure.

Table 44: L2 Switching > Multicast > IGMP Snooping > IGMP Static Groups

Item	Description
VLAN ID	Select the VLAN ID to define IGMP static group.
Group IP Address	Enter the IP address assigned to the VLAN ID.
Member Ports	Enter the port numbers to associate with the static group.
Add	Click Add to add an IGMP group.

The ensuing table for **IGMP Static Groups Status** settings are informational only: VLAN ID, Group IP Address, Member Ports and Modify.

Multicast Groups

To access this page, click **L2 Switching > Multicast > IGMP Snooping > Multicast Groups**.

The ensuing table for **Multicast Groups** settings are informational only: VLAN ID, Group IP Address, Member Ports, Type and Life (Sec).

Router Ports

To access this page, click **L2 Switching > Multicast > IGMP Snooping > Router Ports**.

The ensuing table for **Router Ports** settings are informational only: VLAN ID, Port and Expiry Time (Sec).

MLD Snooping

The MLD Snooping page allows you to select the snooping status (enable or disable), the version (v1 or v2) and the enabling/disabling of the report suppression for the MLD querier, which sends out periodic general MLD queries and are forwarded through all ports in the VLAN.

MLD Settings

To access this page, click **L2 Switching > Multicast > MLD Snooping > MLD Settings**.



Figure 62: L2 Switching > Multicast > MLD Snooping > MLD Settings

The following table describes the items in the previous figure.

Table 45: L2 Switching > Multicast > MLD Snooping > MLD Settings

Item	Description
MLD Snooping State	Select Enable or Disable to set up the MLD Snooping State.
MLD Snooping Version	Select the querier version (V1 or V2) designated to the MLD Snooping Version.
MLD Snooping Report Suppression	Select Enable or Disable to designate the status of the report suppression.
Apply	Click Apply to save the values and update the screen.

The ensuing table for **MLD Snooping Information** settings are informational only: MLD Snooping State, MLD Snooping Version and MLD Snooping V2 Report Suppression.

The ensuing table for **MLD Snooping Table** settings are informational only: Entry No., VLAN ID, MLD Snooping Operation State, Router Ports Auto Learn, Query Robustness, Query Interval (sec.), Query Max Response Interval (sec.), Last Member Query count, Last Member Query Interval (sec), Immediate Leave and **Edit** (click to modify the settings).

MLD Querier

The MLD Querier page allows you to select and enable/disable the MLD querier and define the version (IGMPv1 or IGMPv2) when enabled.

To access this page, click **L2 Switching > Multicast > MLD Snooping > MLD Querier**.

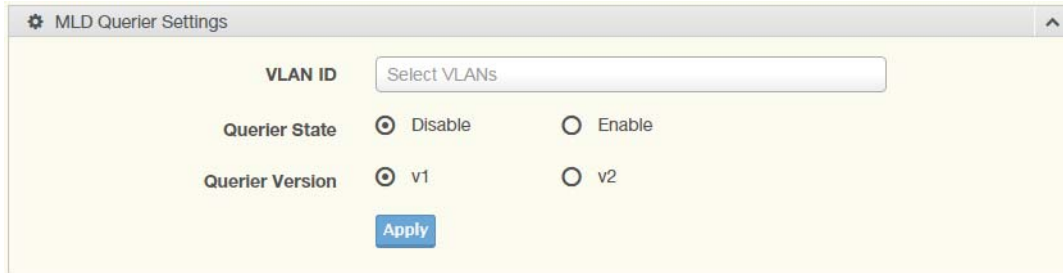

Figure 63: L2 Switching > Multicast > MLD Snooping > MLD Querier

The following table describes the items in the previous figure.

Table 46: L2 Switching > Multicast > MLD Snooping > MLD Querier

Item	Description
VLAN ID	Enter the VLAN ID to configure.
Querier State	Select Enable or Disable status on the selected VLAN. <ul style="list-style-type: none"> ■ Enable: Enable IGMP Querier Election. ■ Disable: Disable IGMP Querier Election.
Querier Version	Select the querier version (IGMPV1 or IGMPV2) designated to the MLD Querier function.
Apply	Click Apply to save the values and update the screen.

The ensuing table for **MLD Querier Status** settings are informational only: VLAN ID, Querier State, Querier Status, Querier Version and Querier IP.

MLD Static Group

The MLD Static Group page allows you to configure specified ports as static member ports.

To access this page, click **L2 Switching > Multicast > MLD Snooping > MLD Static Group**.

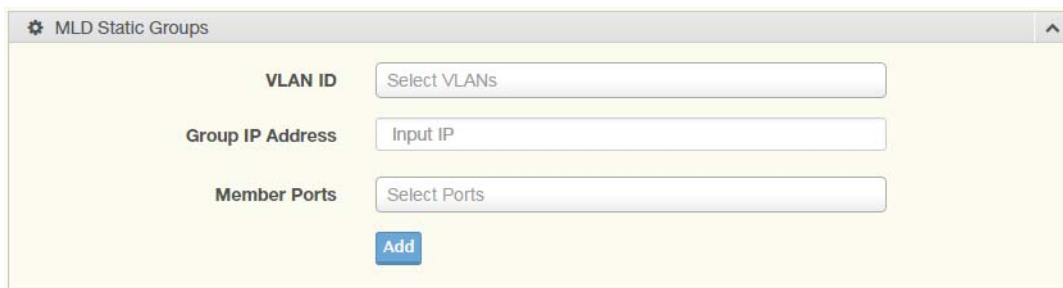

Figure 64: L2 Switching > Multicast > MLD Snooping > MLD Static Group

The following table describes the items in the previous figure.

Table 47: L2 Switching > Multicast > MLD Snooping > MLD Static Group

Item	Description
VLAN ID	Enter the VLAN ID to define the local MLD Static Group.
Group IP Address	Enter the IP address associated with the static group.
Member Ports	Enter the ports designated with the static group.
Add	Click Add to add a MLD static group.

The ensuing table for **MLD Static Groups Status** settings are informational only: VLAN ID, Group IP Address, Member Ports and Modify.

Multicast Groups

To access this page, click **L2 Switching > Multicast > MLD Snooping > Multicast Groups**.

The ensuing table for **Multicast Groups** settings are informational only: ID, Group IP Address, Member Ports, Type and Life (Sec).

Router Ports

To access this page, click **L2 Switching > Multicast > MLD Snooping > Router Ports**.

The ensuing table for **Router Ports** settings are informational only: VLAN ID, Port and Expiry Time (Sec).

Jumbo Frame

Jumbo frames are frames larger than the standard Ethernet frame size of 1518 bytes. The Jumbo Frame function allows the configuration of Ethernet frame size.

To access this page, click **L2 Switching > Jumbo Frame**.



Figure 65: L2 Switching > Jumbo Frame

The following table describes the items in the previous figure.

Table 48: L2 Switching > Jumbo Frame

Item	Description
Jumbo Frame (Bytes)	Enter the variable in bytes (1518 to 9216) to define the jumbo frame size.
Apply	Click Apply to save the values and update the screen.

The ensuing table for **Jumbo Frame Config** settings are informational only: Jumbo Frame (Bytes).

Spanning Tree

The Spanning Tree Protocol (STP) is a network protocol to ensure loop-free topology for any bridged Ethernet local area network.

STP Global Settings

The STP Global Settings page allows you to set the STP status, select the configuration for a BPDU packet, choose the path overhead, force version and set the configuration revision range.

To access this page, click **L2 Switching > Spanning Tree > STP Global Settings**.

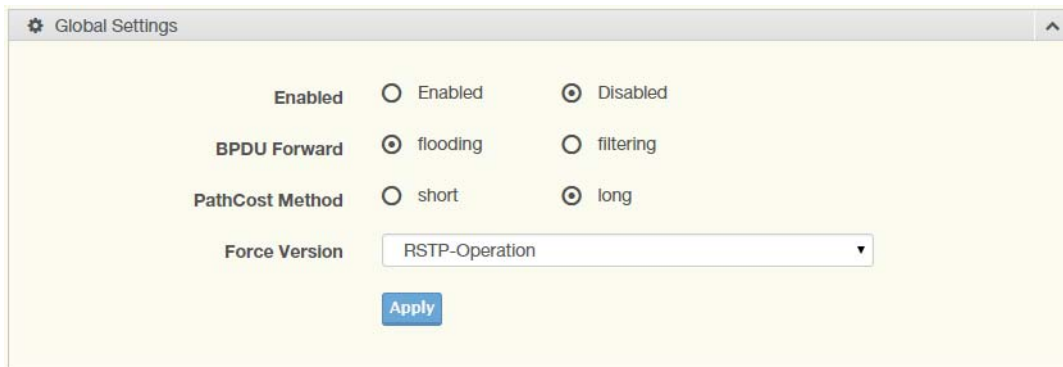

Figure 66: L2 Switching > Spanning Tree > STP Global Settings

The following table describes the items in the previous figure.

Table 49: L2 Switching > Spanning Tree > STP Global Settings

Item	Description
Enabled	Click the radio-button to enable or disable the STP status.
BPDU Forward	Select flooding or filtering to designate the type of BPDU packet.
PathCost Method	Select short or long to define the method of used for path cost calculations.
Force Version	Click the drop-down menu to select the operating mode for STP. <ul style="list-style-type: none"> ■ STP-Compatible: 802.1D STP operation. ■ RSTP-Operation: 802.1w operation.
Apply	Click Apply to save the values and update the screen.

The ensuing table for **STP Information** settings are informational only: STP, BPDU Forward, PathCost Method and Force Version.

STP Port Settings

The STP Port Settings page allows you to configure the ports for the setting, port's contribution, configure edge port, and set the status of the BPDU filter.

To access this page, click **L2 Switching > Spanning Tree > STP Port Settings**.

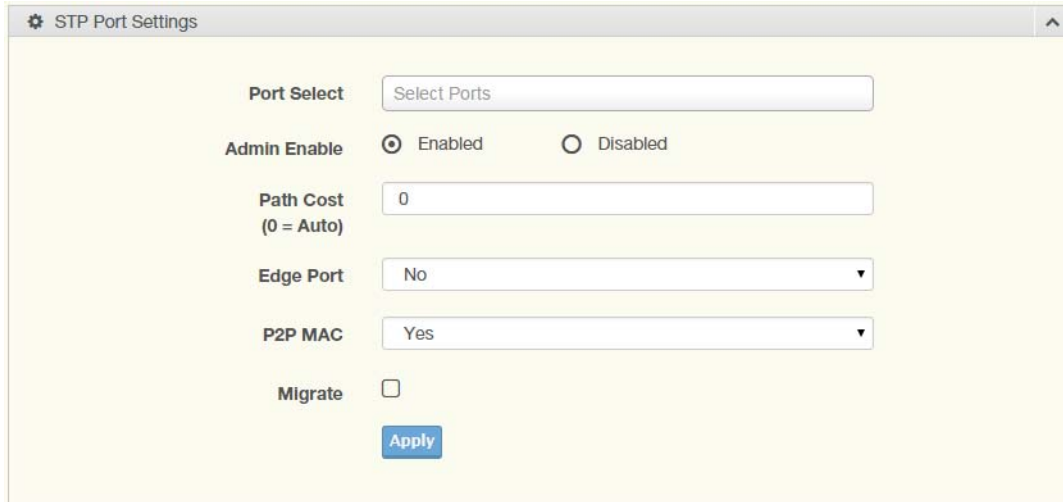

Figure 67: L2 Switching > Spanning Tree > STP Port Settings

The following table describes the items in the previous figure.

Table 50: L2 Switching > Spanning Tree > STP Port Settings

Item	Description
Port Select	Select the port list to specify the ports that apply to this setting.
Admin Enable	Select Enabled or Disabled to set up the admin profile for the STP port.
Path Cost (0 = Auto)	Set the port's cost contribution. For a root port, the root path cost for the bridge. (0 means Auto).
Edge Port	Click the drop-down menu to set the edge port configuration. <ul style="list-style-type: none"> ■ No: Force to false state (as link to a bridge). ■ Yes: Force to true state (as link to a host).
P2P MAC	Click the drop-down menu to set the Point-to-Point port configuration. <ul style="list-style-type: none"> ■ No: Force to false state. ■ Yes: Force to true state.
Migrate	Click the check box to enable the migrate function. Forces the port to use the new MST/RST BPDUs, requiring the switch to test on the LAN segment. for the presence of legacy devices, which are not able to understand the new BPDU formats.
Apply	Click Apply to save the values and update the screen.

The ensuing table for **STP Port Status** settings are informational only: Port, Admin Enable, Path Cost, Edge Port and P2P MAC.

STP Bridge Settings

The STP Bridge Settings page allows you to configure the priority, forward delay, maximum age, Tx hold count, and the hello time for the bridge.

To access this page, click **L2 Switching > Spanning Tree > STP Bridge Settings**.

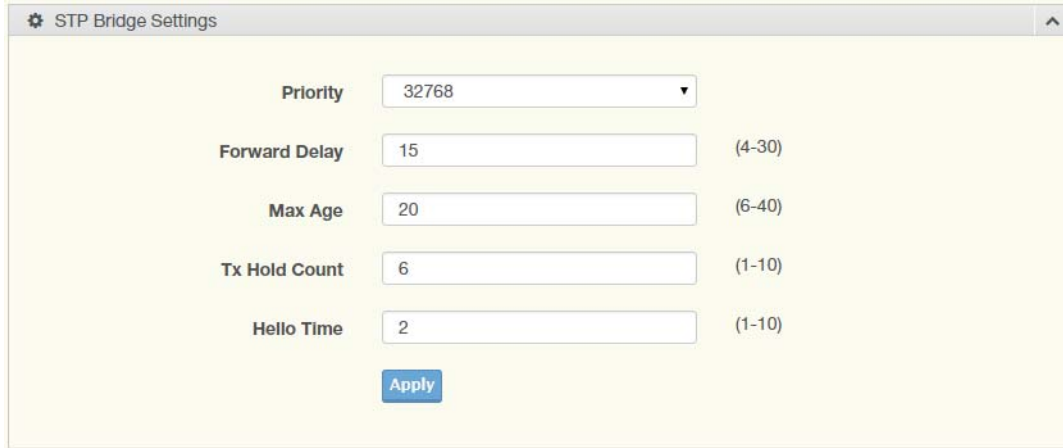

Figure 68: L2 Switching > Spanning Tree > STP Bridge Settings

The following table describes the items in the previous figure.

Table 51: L2 Switching > Spanning Tree > STP Bridge Settings

Item	Description
Priority	Click the drop-down menu to select the STP bridge priority.
Forward Delay	Enter the variable (4 to 30) to set the forward delay for STP bridge settings.
Max Age	Enter the variable (6 to 40) to set the Max age for STP bridge settings.
Tx Hold Count	Enter the variable (1 to 10) to designate the TX hold count for STP bridge settings.
Hello Time	Enter the variable (1 to 10) to designate the Hello Time for STP bridge settings.
Apply	Click Apply to save the values and update the screen.

The ensuing table for **STP Bridge Information** settings are informational only: Priority, Forward Delay, Max Age, Tx Hold Count and Hello Time.

The ensuing table for **STP Bridge Status** settings are informational only: Bridge Identifier, Designated Root Bridge, Root Path Cost, Designated Bridge, Root Port and Last Topology Change.

STP Port Advanced Settings

The STP Port Advanced Settings page allows you to select the port list to apply this setting. To access this page, click **L2 Switching > Spanning Tree > STP Port Advanced Settings**.



Figure 69: L2 Switching > Spanning Tree > STP Port Advanced Settings

The following table describes the items in the previous figure.

Table 52: L2 Switching > Spanning Tree > STP Port Advanced Settings

Item	Description
Port Select	Select the port to designate the STP settings.
Priority	Click the drop-down menu to designate a priority.
Apply	Click Apply to save the values and update the screen.

The ensuing table for **STP Port Status** settings are informational only: Port, Identifier (Priority / Port Id), Path Cost Conf/Oper, Designated Root Bridge, Root Path Cost, Designated Bridge, Edge Port Conf/Oper, P2P MAC Conf/Oper, Port Role and Port State.

MST Config Identification

The MST Config Identification page allows you to configure the identification setting name and the identification range.

To access this page, click **L2 Switching > Spanning Tree > MST Config Identification**.

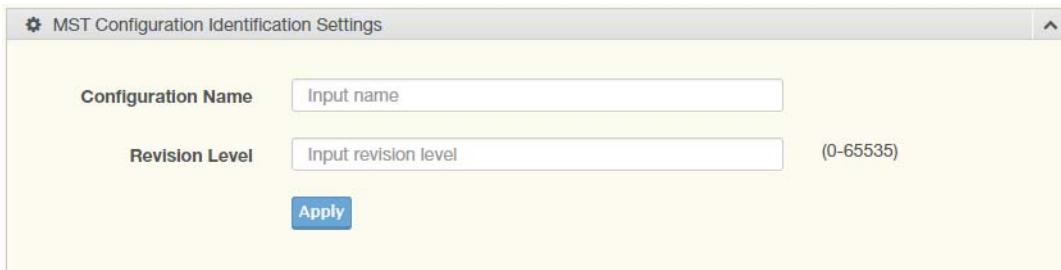

Figure 70: L2 Switching > Spanning Tree > MST Config Identification

The following table describes the items in the previous figure.

Table 53: L2 Switching > Spanning Tree > MST Config Identification

Item	Description
Configuration Name	Enter the identifier used to identify the configuration currently being used. It may be up to 32 characters.
Revision Level	Enter the identifier for the Revision Configuration, range: 0 to 65535 (default: 0).
Apply	Click Apply to save the values and update the screen.

The ensuing table for **MST Configuration Identification Information** settings are informational only: Configuration Name and Revision Level.

MST Instance ID Settings

The MST Instance ID Settings page allows you to edit the MSTI ID and VID List settings. To access this page, click **L2 Switching > Spanning Tree > MST Instance ID Settings**.



Figure 71: L2 Switching > Spanning Tree > MST Instance ID Settings

The following table describes the items in the previous figure.

Table 54: L2 Switching > Spanning Tree > MST Instance ID Settings

Item	Description
MSTI ID	Enter the MST instance ID (0-15).
VID List	Enter the pre-configured VID list.
Move	Click Move to save the values and update the screen.

The ensuing table for **MST Instance ID Information** settings are informational only: MSTI ID and VID List.

MST Instance Priority Settings

The MST Instance Priority Settings allows you to specify the MST instance and the bridge priority in that instance.

To access this page, click **L2 Switching > Spanning Tree > MST Instance Priority Settings**.



Figure 72: L2 Switching > Spanning Tree > MST Instance Priority Settings

The following table describes the items in the previous figure.

Table 55: L2 Switching > Spanning Tree > MST Instance Priority Settings

Item	Description
MSTI ID	Click the drop-down menu to specify the MST instance.
Priority	Click the drop-down menu set the bridge priority in the specified MST instance
Apply	Click Apply to save the values and update the screen.

The ensuing table for **MST Instance Priority Information** settings are informational only: MSTI ID, Priority and Action.

MST Instance Info

To access this page, click **L2 Switching > Spanning Tree > MST Instance Info**.

The ensuing table for **STP Bridge Status** settings are informational only: Bridge Identifier, Designated Root Bridge, Root Path Cost, Designated Bridge, Root Port and TCNLast Topology Change.

The ensuing table for **STP Port Status** settings are informational only: Port, Identifier (Priority / Port Id), Path Cost Conf/Oper, Designated Root Bridge, Root Path Cost, Designated Bridge, Edge Port Conf/Oper, P2P MAC Conf/Oper, Port Role and Port State.

STP Statistics

To access this page, click **L2 Switching > Spanning Tree > STP Statistics**.

The ensuing table for **STP Statistics** settings are informational only: Port, Configuration BPDUs Received, TCN BPDUs Received, Configuration BPDUs Transmitted and TCN BPDUs Transmitted.

X-Ring Elite

The X-Ring Elite function provides an improvement over Spanning Tree and Rapid Spanning Tree and a rapid auto recovery in the event that the network suffers a corrupt or broken link and prevents network loops.

X-Ring Elite Settings

The X-Ring Elite Settings allows you to enable or disable the state of the X-Ring settings.

To access this page, click **L2 Switching > X-Ring Elite > X-Ring Elite Settings**.



Figure 73: L2 Switching > X-Ring Elite > X-Ring Elite Settings

The following table describes the items in the previous figure.

Table 56: L2 Switching > X-Ring Elite > X-Ring Elite Settings

Item	Description
State	Select Enabled or Disabled to set up the X-Ring Elite mode.
Apply	Click Apply to save the values and update the screen.

The ensuing table for **Information** settings are informational only: X-Ring Elite State.

X-Ring Elite Groups

The X-Ring Elite Groups page allows you to select the function and role for each device and the connected ports.

To access this page, click **L2 Switching > X-Ring Elite > X-Ring Elite Groups**.



Figure 74: L2 Switching > X-Ring Elite > X-Ring Elite Groups

The ensuing table for **Information** settings is informational only: Ring ID, Role, Port 1, Port 2 and **Delete** (click to delete the desired Ring ID).

Loopback Detection

The Loopback Detection function is used to detect looped links. By sending detection frames and then checking to see if the frames returned to any port on the device, the function is used to detect loops.

Global Settings

The Global Settings page allows you to configure the state (enabled or disabled) of the function, select the interval at which frames are transmitted and the delay before recovery.

To access this page, click **L2 Switching > Loopback Detection > Global Settings**.



Figure 75: L2 Switching > Loopback Detection > Global Settings

The following table describes the items in the previous figure.

Table 57: L2 Switching > Loopback Detection > Global Settings

Item	Description
State	Select Enabled or Disabled to set up the loopback mode.
Interval	Enter the variable in seconds (1 to 32767) to set the interval at which frames are transmitted.
Recover Time	Enter the variable in seconds (60 to 1000000) to define the delay before recovery.
Apply	Click Apply to save the values and update the screen.

The ensuing table for **Loopback Detection Global Information** settings are informational only: State, Interval and Recover Time.

Port Settings

The Port Settings page allows you to select ports that are detected by the loopback detection function and configure their status (enabled or disabled).

To access this page, click **L2 Switching > Loopback Detection > Port Settings**.

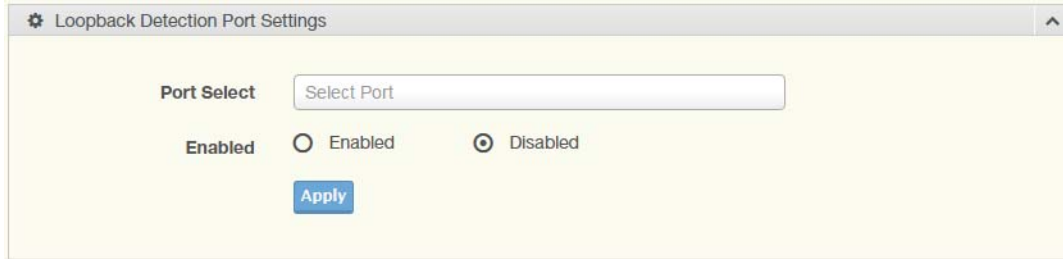

Figure 76: L2 Switching > Loopback Detection > Port Settings

The following table describes the items in the previous figure.

Table 58: L2 Switching > Loopback Detection > Port Settings

Item	Description
Port Select	Enter the port to define the local loopback detection setting.
Enabled	Select Enabled or Disabled to set up the Loopback Detection function.
Apply	Click Apply to save the values and update the screen.

The ensuing table for **Loopback Detection Port Information** settings are informational only: Port, Enable State and Loop Status.

MAC Address Table

The MAC Address Table provides access to the Static MAC Settings, MAC Aging Time, and Dynamic Forwarding.

Static MAC

The Static MAC page allows you to configure the address for forwarding of packets, the VLAN ID of the listed MAC address and the designated Port.

To access this page, click **MAC Address Table > Static MAC**.

Figure 77: MAC Address Table > Static MAC

The following table describes the items in the previous figure.

Table 59: MAC Address Table > Static MAC

Item	Description
MAC Address	Enter the MAC address to which packets are statically forwarded.
VLAN	Click the drop-down menu to select the VLAN ID number of the VLAN for which the MAC address is residing.
Port	Click the drop-down menu to select the port number.
Apply	Click Apply to save the values and update the screen.

The ensuing table for **Static MAC Status** settings are informational only: No., MAC Address, VLAN, Port and **Delete** (click to delete the desired MAC address).

MAC Aging Time

The MAC Aging Time page allows you to set the MAC address of the aging time to study. To access this page, click **MAC Address Table > MAC Aging Time**.



Figure 78: MAC Address Table > MAC Aging Time

The following table describes the items in the previous figure.

Table 60: MAC Address Table > MAC Aging Time

Item	Description
Aging Time	Enter the variable (10 to 630) to define the time required for aging.
Apply	Click Apply to save the values and update the screen.

The ensuing table for **Dynamic Address Status** settings are informational only: Aging time.

Dynamic Forwarding Table

The Dynamic Forwarding function allows you to configure an address tables, which contain the following:

- The port each hardware address is associated with
- The VLAN to show or clear dynamic MAC entries
- The MAC address selection

To access this page, click **MAC Address Table > Dynamic Forwarding Table**.

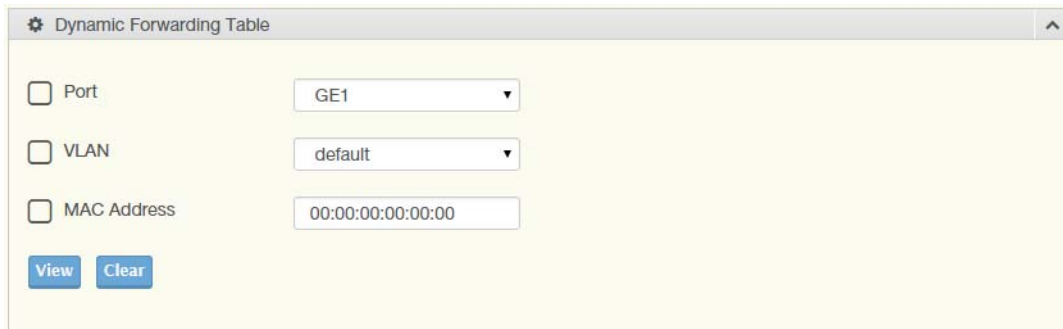

Figure 79: MAC Address Table > Dynamic Forwarding Table

The following table describes the items in the previous figure.

Table 61: MAC Address Table > Dynamic Forwarding Table

Item	Description
Port	Click the drop-down menu to select the port number to show or clear dynamic MAC entries. If a port, VLAN or MAC address is not selected the whole dynamic MAC table is displayed or cleared.
VLAN	Click the drop-down menu to select the VLAN to show or clear dynamic MAC entries.

Table 61: MAC Address Table > Dynamic Forwarding Table (Continued)

Item	Description
MAC Address	Enter the MAC address to show or clear dynamic MAC entries. If a port, VLAN or MAC address is not selected the whole dynamic MAC table is displayed or cleared.
View	Click View to display the MAC address information.
Clear	Click Clear to clear the MAC Address Information table.

The ensuing table for **MAC Address Information** settings are informational only: MAC Address, VLAN, Type, Port and **Add to Static MAC** (click to add the MAC address to static MAC address list).

Security

The Security function allows for the configuration of Storm Control, Port Security, Protected Ports, DoS Prevention, Applications, and 802.1x.

Storm Control

The Storm Control page allows you to set up the units and Preamble/IFG to manage the occurrence of packet flooding on the LAN and consequent traffic to prevent the degrading of network performance.

Global Settings

To access this page, click **Security > Storm Control > Global Settings**.

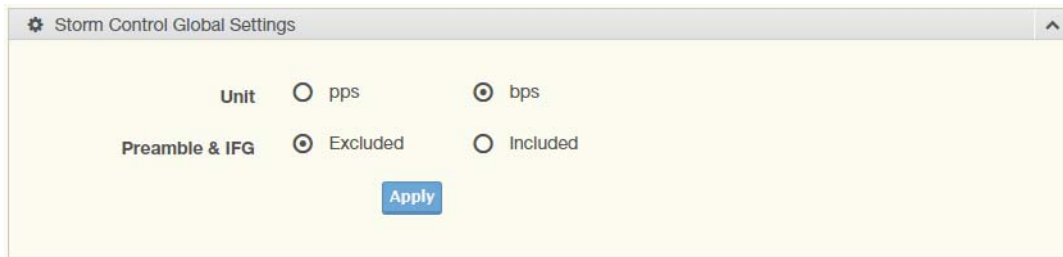

Figure 80: Security > Storm Control > Global Settings

The following table describes the items in the previous figure.

Table 62: Security > Storm Control > Global Settings

Item	Description
Unit	Select pps or bps control units for the Storm Control function.
Preamble & IFG	Select Excluded or Included to set up the Storm Control Global settings. <ul style="list-style-type: none"> ■ Excluded: exclude preamble & IFG (20 bytes) when count ingress storm control rate. ■ Included: include preamble & IFG (20 bytes) when count ingress storm control rate.
Apply	Click Apply to save the values and update the screen.

The ensuing table for **Storm Control Global Information** settings are informational only: Unit and Preamble & IFG.

Port Settings

The Port Settings page allows you to configure the port and the type of storm control association along with the value of the storm rate for the selected port.

To access this page, click **Security > Storm Control > Port Settings**.

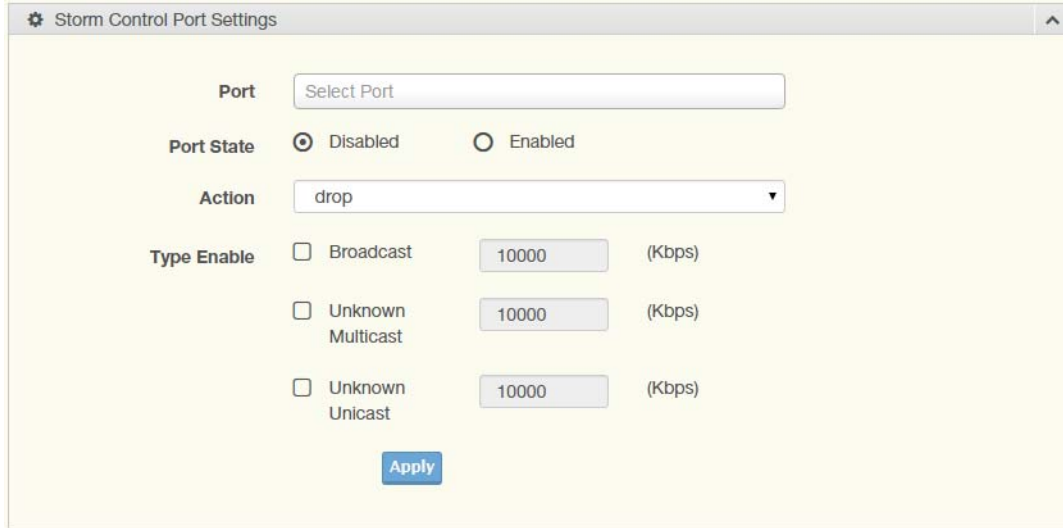

Figure 81: Security > Storm Control > Port Settings

The following table describes the items in the previous figure.

Table 63: Security > Storm Control > Port Settings

Item	Description
Port	Enter the port number to designate the local port for the Storm Control function.
Port State	Select Disabled or Enabled to define the port state
Action	Click the drop-down menu to select the type of action to designate for the selected port during a Storm Control incident. The options are Drop and Shutdown.
Type Enable	Click the radio button to enable Broadcast, Unknown Multicast, or Unknown Unicast. <ul style="list-style-type: none"> ■ Broadcast: Select the variable in Kbps to define the broadcast bandwidth. ■ Unknown Multicast: Select the variable in Kbps to define the multicast setting. ■ Broadcast: Select the variable in Kbps to define the unknown unicast setting.
Apply	Click Apply to save the values and update the screen.

The ensuing table for **Storm Control Port Information** settings are informational only: Port, Port State, Broadcast (Kbps), Unknown Multicast (Kbps), Unknown Unicast (Kbps) and Action.

Port Security

The Port Security page allows you to configure port isolation behavior. To access this page, click **Security > Port Security**.

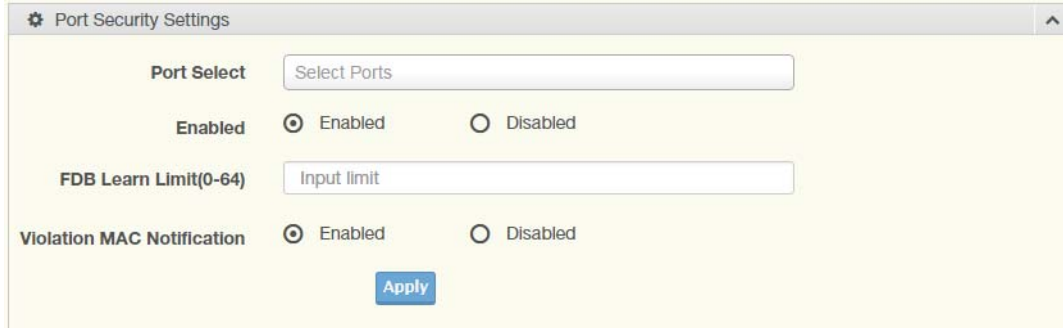

Figure 82: Security > Port Security

The following table describes the items in the previous figure.

Table 64: Security > Port Security

Item	Description
Port Select	Enter a single or multiple port numbers to configure.
Enabled	Select Enabled or Disabled to define the selected Port.
FDB Learn Limit (0-64)	Enter the variable (0 to 64) to set the learn limit for the FDB setting.
Violation MAC Notification	Select Enabled or Disabled to define the selected Port.
Apply	Click Apply to save the values and update the screen.

The ensuing table for **Port Security Information** settings are informational only: Port, Enabled, FDB Learn Limit and Violation MAC Notification.

Protected Ports

The Protected Port page allows you to configure a single or multiple ports as a protected or unprotected type.

To access this page, click **Security > Protected Ports**.

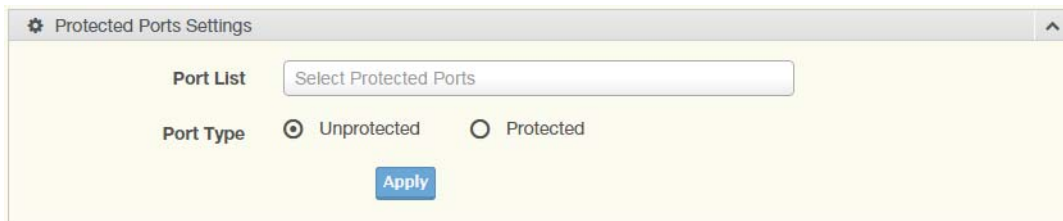

Figure 83: Security > Protected Ports

The following table describes the items in the previous figure.

Table 65: Security > Protected Ports

Item	Description
Port List	Enter the port number to designate for the Protected Port setting.
Port Type	Select Unprotected or Protected to define the port type.
Apply	Click Apply to save the values and update the screen.

The ensuing table for **Protected Ports Status** settings are informational only: Protected Ports and Unprotected Ports.

DoS Prevention

The DoS Prevention page allows you to set up (enabled or disabled) the denial of service.

DoS Global Settings

The DoS Global Settings page allows you to configure (enabled or disabled) the setting for each function.

To access this page, click **Security > DoS Prevention > DoS Global Settings**.

Setting	Enabled	Disabled	Value / Range
DMAC = SMAC	<input checked="" type="radio"/>	<input type="radio"/>	
LAND	<input checked="" type="radio"/>	<input type="radio"/>	
UDP Blat	<input checked="" type="radio"/>	<input type="radio"/>	
TCP Blat	<input checked="" type="radio"/>	<input type="radio"/>	
POD	<input checked="" type="radio"/>	<input type="radio"/>	
IPv6 Min Fragment	<input checked="" type="radio"/>	<input type="radio"/>	
			Bytes: 1240 (0-65535)
ICMP Fragments	<input checked="" type="radio"/>	<input type="radio"/>	
IPv4 Ping Max Size	<input checked="" type="radio"/>	<input type="radio"/>	
IPv6 Ping Max Size	<input checked="" type="radio"/>	<input type="radio"/>	
Ping Max Size Setting			Bytes: 512 (0-65535)
Smurf Attack	<input checked="" type="radio"/>	<input type="radio"/>	
			Netmask Length: 0 (0-32)
TCP Min Hdr Size	<input checked="" type="radio"/>	<input type="radio"/>	
			Byte: 20 (0-31)
TCP-SYN(SPORT<1024)	<input checked="" type="radio"/>	<input type="radio"/>	
Null Scan Attack	<input checked="" type="radio"/>	<input type="radio"/>	
X-Mas Scan Attack	<input checked="" type="radio"/>	<input type="radio"/>	
TCP SYN-FIN Attack	<input checked="" type="radio"/>	<input type="radio"/>	
TCP SYN-RST Attack	<input checked="" type="radio"/>	<input type="radio"/>	
TCP Fragment (Offset = 1)	<input checked="" type="radio"/>	<input type="radio"/>	

Apply

Figure 84: Security > DoS Prevention > DoS Global Settings

The following table describes the items in the previous figure.

Table 66: Security > DoS Prevention > DoS Global Settings

Item	Description
DMAC = SMAC	Click Enabled or Disabled to define DMAC-SMAC for the DoS Global settings.
LAND	Click Enabled or Disabled to define LAND for the DoS Global settings.
UDP Blat	Click Enabled or Disabled to define UDP Blat for the DoS Global settings.
TCP Blat	Click Enabled or Disabled to define TCP Blat for the DoS Global settings.
POD	Click Enabled or Disabled to define POD for the DoS Global settings.
IPv6 Min Fragment	Click Enabled or Disabled to define minimum fragment size for the IPv6 protocol. Enter the variable in bytes (0 to 65535) to set the minimum fragment size when the function is enabled.
ICMP Fragments	Click Enabled or Disabled to define the ICMP Fragments function.
IPv4 Ping Max Size	Click Enabled or Disabled to set the maximum ping size for the IPv4 protocol.
IPv6 Ping Max Size	Click Enabled or Disabled to set a maximum ping size for the IPv6 protocol.
Ping Max Size Setting	Enter the variable in bytes (0 to 65535) to set the maximum ping size.
Smurf Attack	Click Enabled or Disabled to set the Smurf Attack function.
TCP Min Hdr Size	Click Enabled or Disabled to set the minimum header size. Enter the variable in bytes (0 to 31) to set the minimum header size.
TCP-SYN (SPORT < 1024)	Click Enabled or Disabled to set the TCP synchronization function (sport < 1021).
Null Scan Attack	Click Enabled or Disabled to set the Null Scan Attack function.
X-Mas Scan Attack	Click Enabled or Disabled to set the X-Mas Scan function.
TCP SYN-FIN Attack	Click Enabled or Disabled to set the TCP synchronization termination attack function.
TCP SYN-RST Attack	Click Enabled or Disabled to set the TCP synchronization reset attack function.
TCP Fragment (Offset = 1)	Click Enabled or Disabled to set the TCP fragment function (offset =1).
Apply	Click Apply to save the values and update the screen.

The ensuing table for **DoS Global Information** settings are informational only: DMAC = SMAC, Land Attack, UDP Blat, TCP Blat, POD (Ping of Death), IPv6 Min Fragment Size, ICMP Fragment Packets, IPv4 Ping Max Packet Size, IPv6 Ping Max Packet Size, Smurf Attack, TCP Min Header Length, TCP Syn (SPORT < 1024), Null Scan Attack, X-Mas Scan Attack, TCP SYN-FIN Attack, TCP SYN-RST Attack and TCP Fragment (Offset = 1).

DoS Port Settings

The DoS Port Settings page allow you to configure DoS security (enabled or disabled) for the selected port.

To access this page, click **Security > DoS Prevention > DoS Port Settings**.

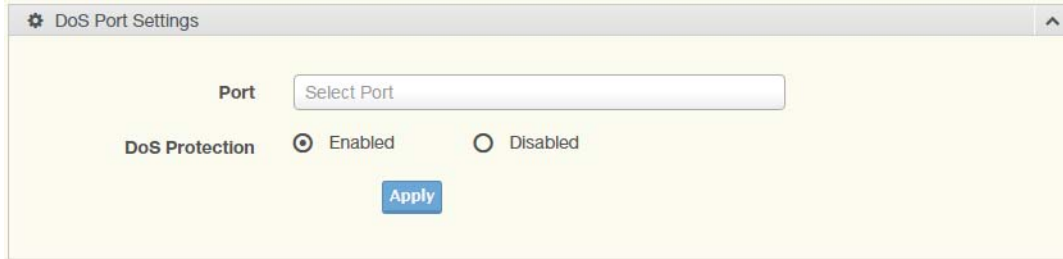

Figure 85: Security > DoS Prevention > DoS Port Settings

The following table describes the items in the previous figure.

Table 67: Security > DoS Prevention > DoS Port Settings

Item	Description
Port	Select the port to configure for the DoS prevention function.
DoS Protection	Click Enabled or Disabled to set the DoS Port security function state.
Apply	Click Apply to save the values and update the screen.

The ensuing table for **DoS Port Status** settings are informational only: Port and DoS Protection.

Applications

The Applications function allows you to configure various types of AAA lists.

HTTP

The HTTP page allows you to combine all kinds of AAA lists to the HTTP line. Attempts to access the switch’s Web UI from HTTP are first authenticated.

To access this page, click **Security > Applications > HTTP**.

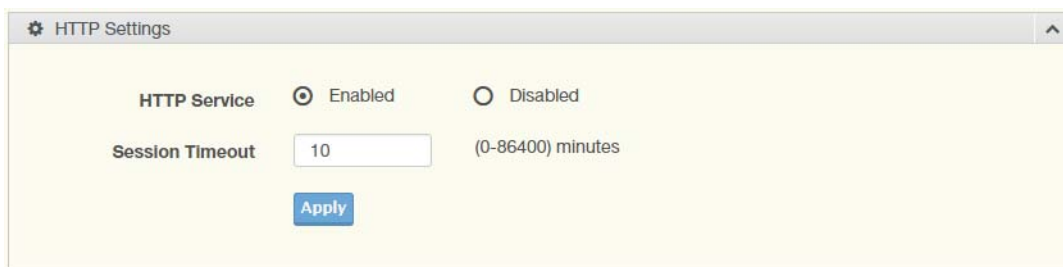

Figure 86: Security > Applications > HTTP

The following table describes the items in the previous figure.

Table 68: Security > Applications > HTTP

Item	Description
HTTP Service	Click Enabled or Disabled to set up Ethernet encapsulation (remote access) through HTTP function.
Session Timeout	Enter the variable in minutes (0 to 86400) to define the timeout period for the HTTP session.
Apply	Click Apply to save the values and update the screen.

The ensuing table for **HTTP Information** settings are informational only: HTTP Service and Session Timeout.

802.1x

The 802.1x function provides port-based authentication to prevent unauthorized devices (clients) from gaining access to the network.

802.1x Settings

The 802.1x Settings page allows you to set the state (enabled or disabled) for the selected IP server address, port, accounting port and associated password, including a re-authentication period.

To access this page, click **Security > 802.1x > 802.1x Settings**.

Figure 87: Security > 802.1x > 802.1x Settings

The following table describes the items in the previous figure.

Table 69: Security > 802.1x > 802.1x Settings

Item	Description
State	Click Enabled or Disabled to set up 802.1x Setting function.
Server IP	Enter the IP address of the local server providing authentication function.
Server Port	Enter the port number (1 to 65535) assigned to the listed Server IP.
Accounting Port	Enter the port number (1 to 65535) assigned to the listed server IP configured to provide authorization and authentication for network access.
Security Key	Enter the variable to define the network security key used in authentication.
Reauth Period	Enter the variable in seconds to define the period of time between authentication attempts.
Apply	Click Apply to save the values and update the screen.

The ensuing table for **802.1x Information** settings are informational only: 802.1x State, Server IP, Server Port, Accounting Port, Security Key and Reauth Period.

802.1x Port Configuration

The 802.1x Port Configuration page allows you to identify the authorization state for a port by using a MAC or Port authentication base.

To access this page, click **Security > 802.1x > 802.1x Port Configuration**.

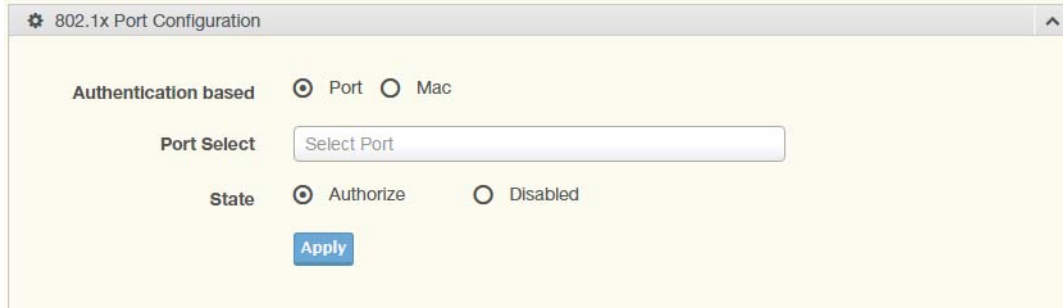

Figure 88: Security > 802.1x > 802.1x Port Configuration

The following table describes the items in the previous figure.

Table 70: Security > 802.1x > 802.1x Port Configuration

Item	Description
Authentication based	Click Port or Mac to designate the type of configuration for the 802.1x Port setting.
Port Select	Enter the port number associated with the configuration setting.
State	Click Authorize or Disabled to define the listed port's state mode.
Apply	Click Apply to save the values and update the screen.

The ensuing table for **802.1x Port Authorization** settings are informational only: Port and Port State.

QoS

The QoS function allows you to configure settings for the switch QoS interface and how the switch connects to a remote server to get services.

General

Traditionally, networks operate on a best-effort delivery basis, all traffic has equal priority and an equal chance of being delivered in a timely manner. When there is congestion, all traffic has an equal chance of being dropped.

The QoS feature can be configured for congestion-management and congestion-avoidance to specifically manage the priority of the traffic delivery. Implementing QoS in the network makes performance predictable and bandwidth utilization much more effective.

The QoS implementation is based on the prioritization values in Layer 2 frames.

QoS Properties

The QoS Properties allows you to set the QoS mode.

To access this page, click **QoS > General > QoS Properties**.

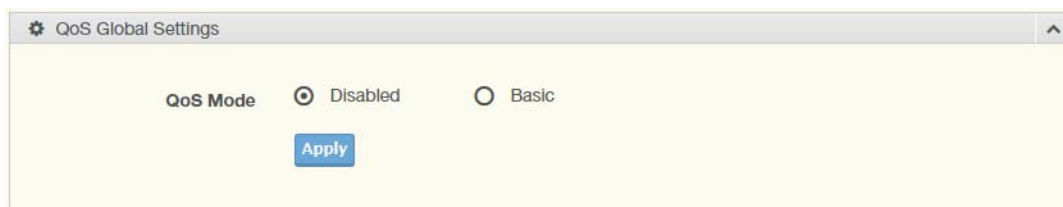

Figure 89: QoS > General > QoS Properties

The following table describes the items in the previous figure.

Table 71: QoS > General > QoS Properties

Item	Description
QoS Mode	Select Disabled or Basic to set up the QoS function.
Apply	Click Apply to save the values and update the screen.

The ensuing table for **QoS Global Information** settings are informational only: QoS Mode.

QoS Settings

Once the QoS function is enabled, you can configure the available settings.

To access this page, click **QoS > General > QoS Settings**.

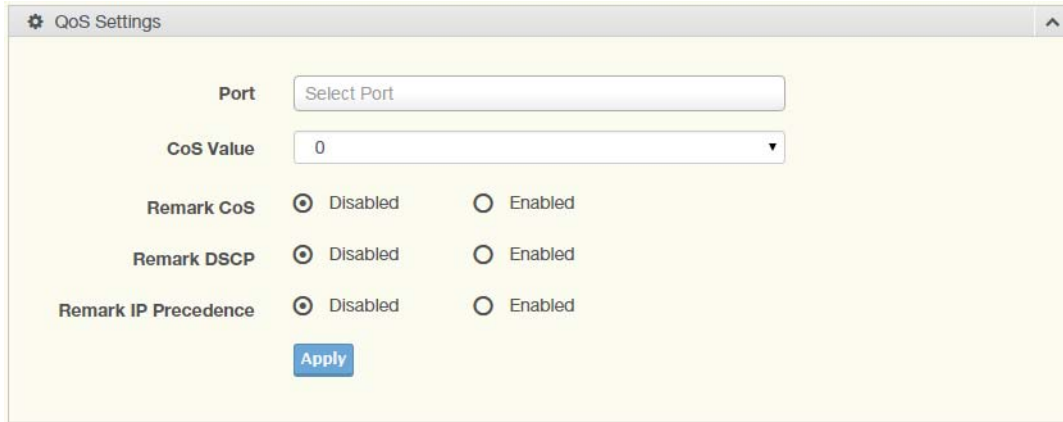

Figure 90: QoS > General > QoS Settings

The following table describes the items in the previous figure.

Table 72: QoS > General > QoS Settings

Item	Description
Port	Enter the port number to associate with the QoS setting.
CoS Value	Click the drop-down menu to designate the Class of Service (CoS) value (0 to 7) for the Port entry.
Remark CoS	Click Disabled or Enabled to set up the Remark CoS function. When enabled the LAN (preassigned priority values) is marked at Layer 2 boundary to CoS values.
Remark DSCP	Click Disabled or Enabled to set up the DSCP remark option for the QoS function.
Remark IP Precedence	Click Disabled or Enabled to set up the Remark IP Precedence for the QoS function.
Apply	Click Apply to save the values and update the screen.

The ensuing table for **QoS Status** settings are informational only: Port, CoS value, Remark CoS, Remark DSCP and Remark IP Precedence.

Queue Scheduling

The switch support eight CoS queues for each egress port. For each of the eight queues, two types of scheduling can be configured: Strict Priority and Weighted Round Robin (WRR).

Strict Priority scheduling is based on the priority of queues. Packets in a high-priority queue are always sent first and packets in a low-priority queue are only sent after all the high priority queues are empty.

Weighted RoundRobin (WRR) scheduling is based on the user priority specification to indicate the importance (weight) of the queue relative to the other CoS queues. WRR scheduling prevents low-priority queues from being completely ignored during periods of high priority traffic. The WRR scheduler sends some packets from each queue in turn.

To access this page, click **QoS > General > QoS Scheduling**.

Queue	Strict	WRR	Weight	% of WRR Bandwidth
1	<input checked="" type="radio"/>	<input type="radio"/>	1	
2	<input checked="" type="radio"/>	<input type="radio"/>	2	
3	<input checked="" type="radio"/>	<input type="radio"/>	3	
4	<input checked="" type="radio"/>	<input type="radio"/>	4	
5	<input checked="" type="radio"/>	<input type="radio"/>	5	
6	<input checked="" type="radio"/>	<input type="radio"/>	9	
7	<input checked="" type="radio"/>	<input type="radio"/>	13	
8	<input checked="" type="radio"/>	<input type="radio"/>	15	

Figure 91: QoS > General > QoS Scheduling

The following table describes the items in the previous figure.

Table 73: QoS > General > QoS Scheduling

Item	Description
Queue	Queue entry for egress port.
Strict	Select Strict to assign the scheduling designation to the selected queue.
WRR	Select WRR to assign the scheduling designation to the selected queue.
Weight	Enter a queue priority (weight) relative to the defined entries (WRR only).
% of WRR Bandwidth	Displays the allotted bandwidth for the queue entry in percentage values.
Apply	Click Apply to save the values and update the screen.

The ensuing table for **Queue Information** settings are informational only: Strict Priority Queue Number.

CoS Mapping

The CoS Mapping allows you to apply CoS mapping.

To access this page, click **QoS > General > CoS Mapping**.

Figure 92: QoS > General > CoS Mapping

The following table describes the items in the previous figure.

Table 74: QoS > General > CoS Mapping

Item	Description
CoS to Queue Mapping	
Class of Service	Displays the CoS for the queue entry.
Queue	Click the drop-down menu to select the queue priority for selected CoS
Queue to CoS Mapping	
Queue	Displays the queue entry for CoS mapping.
Class of Service	Click the drop-down menu to select the CoS type
Apply	Click Apply to save the values and update the screen.

The ensuing table for **CoS Mapping Information** settings are informational only: CoS and Mapping to Queue.

The ensuing table for **Queue Mapping Information** settings are informational only: Queue and Mapping to CoS.

DSCP Mapping

The DSCP to Queue mapping function maps queue values in incoming packets to a DSCP value that QoS uses internally to represent the priority of the traffic. The following table shows the DSCP to Queue map.

If these values are not appropriate for your network, you need to modify them.

To access this page, click **QoS > General > DSCP Mapping**.

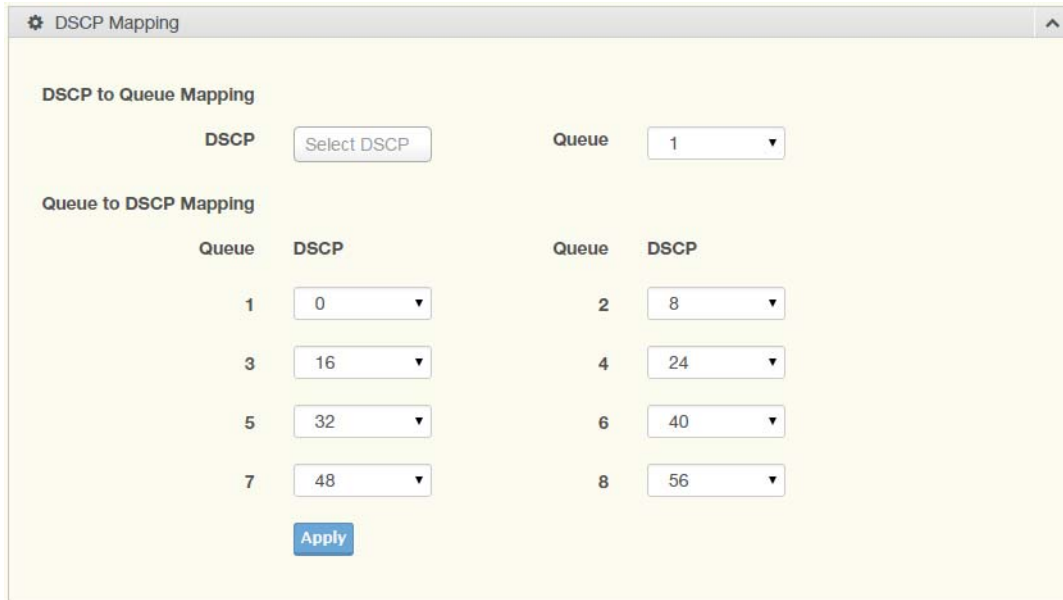

Figure 93: QoS > General > DSCP Mapping

The following table describes the items in the previous figure.

Table 75: QoS > General > DSCP Mapping

Item	Description
DSCP to Queue Mapping	
DSCP	Enter the DSCP entry to define the precedence values.
Queue	Click the drop-down menu to select the queue designation for the DSCP value.
Queue to DSCP Mapping	
Queue	Displays the queue value for the DSCP map.
DSCP	Enter the DSCP entry to define the precedence values.
Apply	Click Apply to save the values and update the screen.

The ensuing table for **DSCP Mapping Information** settings are informational only: DSCP and Mapping to Queue.

The ensuing table for **Queue Mapping Information** settings are informational only: Queue and Mapping to DSCP.

IP Precedence Mapping

The IP Precedence Mapping allows you to set IP Precedence mapping.

To access this page, click **QoS > General > IP Precedence Mapping**.

Figure 94: QoS > General > IP Precedence Mapping

The following table describes the items in the previous figure.

Table 76: QoS > General > IP Precedence Mapping

Item	Description
IP Precedence to Queue Mapping	
IP Precedence	Displays the IP precedence value for the queue map.
Queue	Click the drop-down menu to map a queue value to the selected IP precedence.
Queue to IP Precedence Mapping	
Queue	Displays the queue entry for mapping IP precedence values.
IP Precedence	Click the drop-down menu to map an IP precedence value to the selected queue.
Apply	Click Apply to save the values and update the screen.

The ensuing table for **IP Precedence Mapping Information** settings are informational only: IP Precedence and Mapping to Queue.

The ensuing table for **Queue Mapping Information** settings are informational only: Queue and Mapping to IP Precedence.

QoS Basic Mode

Quality of Service (QoS) allows to give preferential treatment to certain types of traffic at the expense of others. Without QoS, the switch offers best-effort service to each packet, regardless of the packet contents or size sending the packets without any assurance of reliability, delay bounds, or throughput.

QoS mode supports two modes: 802.1p and DSCP.

Global Settings

The Global Settings page allows you to configure the trust mode to a port selection.

To access this page, click **QoS > QoS Basic Mode > Global Settings**.

The function is only available when **QoS Properties** is set to **Basic**.



Figure 95: QoS > QoS Basic Mode > Global Settings

The following table describes the items in the previous figure.

Table 77: QoS > QoS Basic Mode > Global Settings

Item	Description
Trust Mode	Click the drop-down menu to select the trust state of the QoS basic mode.
Apply	Click Apply to save the values and update the screen.

The ensuing table for **QoS Information** settings are informational only: Trust Mode.

Port Settings

The Port Settings page allows you to define a trust state (enabled or disabled) to a listed port.

To access this page, click **QoS > QoS Basic Mode > Port Settings**.



Figure 96: QoS > QoS Basic Mode > Port Settings

The following table describes the items in the previous figure.

Table 78: QoS > QoS Basic Mode > Port Settings

Item	Description
Port	Enter the port number for the QoS basic mode setting.
Trust State	Select Enabled or Disabled to set the port's trust state status.
Apply	Click Apply to save the values and update the screen.

The ensuing table for **QoS Port Status** settings are informational only: Port and Trust State.

Rate Limit

Rate Limits features control on a per port basis. Bandwidth control is supported for the following: Ingress Bandwidth Control, Egress Bandwidth Control and Egress Queue.

Ingress Bandwidth Control

The Ingress Bandwidth Control page allows you to configure the bandwidth control for a listed port.

To access this page, click **QoS > Rate Limit > Ingress Bandwidth Control**.

Figure 97: QoS > Rate Limit > Ingress Bandwidth Control

The following table describes the items in the previous figure.

Table 79: QoS > Rate Limit > Ingress Bandwidth Control

Item	Description
Port	Enter the port number for the rate limit set up.
State	Select Disabled or Enabled to set the port's state status.
Rate (Kbps)	Enter the value in Kbps (16 to 1000000) to set as the bandwidth rate for the selected port.
Apply	Click Apply to save the values and update the screen.

The ensuing table for **Ingress Bandwidth Control Status** settings are informational only: Port and Ingress Rate Limit (Kbps).

Egress Bandwidth Control

The Egress Bandwidth Control page allows you to set the egress bandwidth control for a listed port.

To access this page, click **QoS > Rate Limit > Egress Bandwidth Control**.

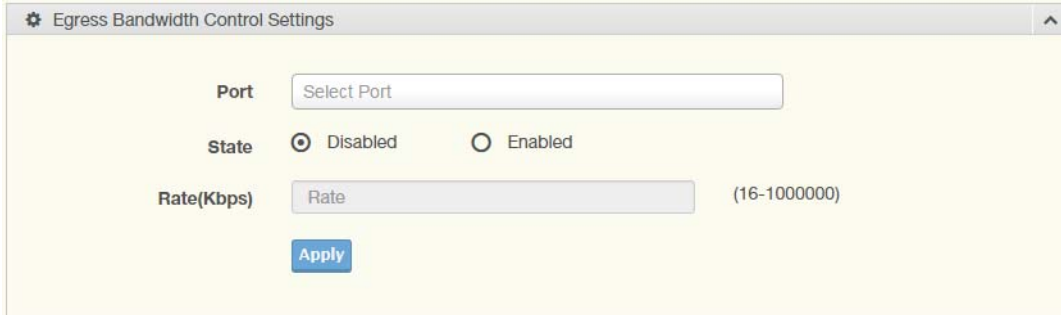

Figure 98: QoS > Rate Limit > Egress Bandwidth Control

The following table describes the items in the previous figure.

Table 80: QoS > Rate Limit > Egress Bandwidth Control

Item	Description
Port	Enter the port number to set the Egress Bandwidth Control.
State	Select Disabled or Enabled to set the Egress Bandwidth Control state.
Rate (Kbps)	Enter the value in Kbps (16 to 1000000) to set the Egress Bandwidth rate.
Apply	Click Apply to save the values and update the screen.

The ensuing table for **Egress Bandwidth Control Status** settings are informational only: Port and Egress Rate Limit (Kbps).

Egress Queue

The Egress Queue page allows you to set the egress bandwidth parameters.

To access this page, click **QoS > Rate Limit > Egress Queue**.

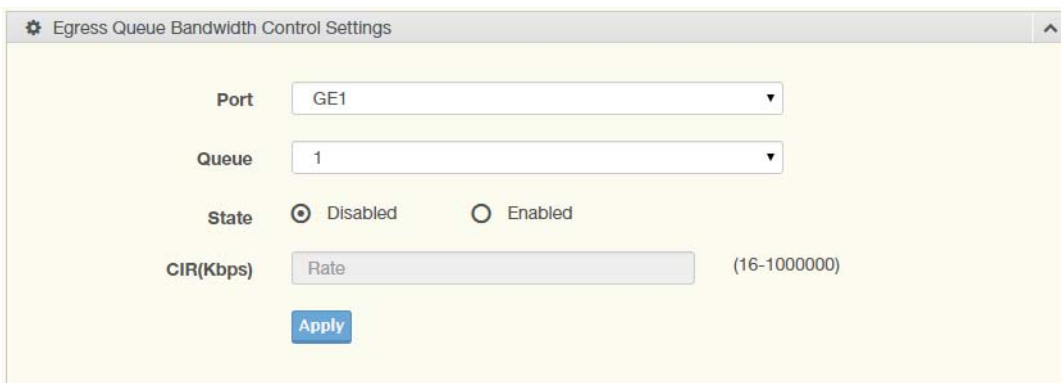

Figure 99: QoS > Rate Limit > Egress Queue

The following table describes the items in the previous figure.

Table 81: QoS > Rate Limit > Egress Queue

Item	Description
Port	Click the drop-down menu to select the port to define the Egress queue.
Queue	Click the drop-down menu to set the queue order for the Egress setting.
State	Click Disabled or Enabled to set the Egress queue state.

Table 81: QoS > Rate Limit > Egress Queue (Continued)

Item	Description
CIR (Kbps)	Enter the value in Kbps (16 to 1000000) to set the CIR rate for the Egress queue.
Apply	Click Apply to save the values and update the screen.

The ensuing table for **FE1 Egress Per Queue Status** settings are informational only: Queue Id and Egress Rate Limit (Kbps).

Management

LLDP

LLDP is a one-way protocol without request/response sequences. Information is advertised by stations implementing the transmit function, and is received and processed by stations implementing the receive function.

LLDP System Settings

The LLDP System Settings allows you to configure the status (enabled or disabled) for the protocol, set the interval for frame transmission, set the hold time multiplier and the re-initialization delay.

To access this page, click **Management > LLDP > LLDP System Settings**.

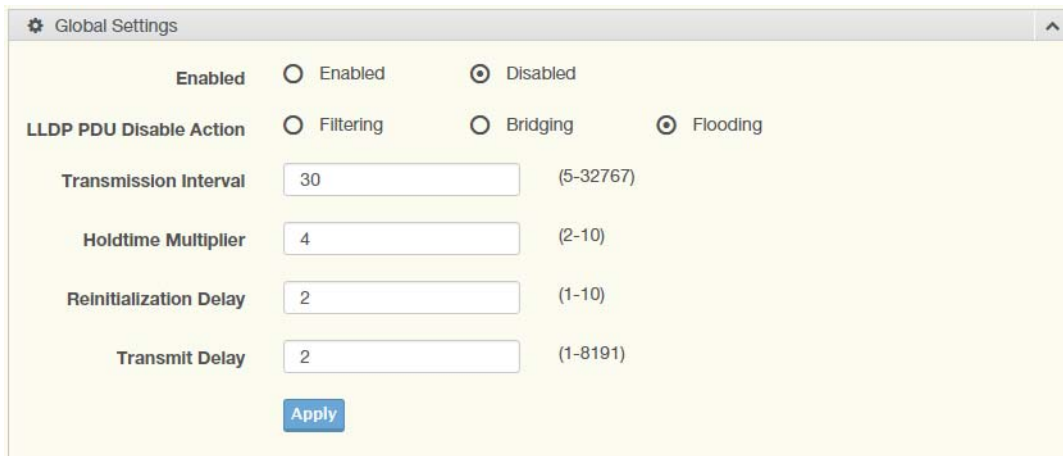

Figure 100: Management > LLDP > LLDP System Settings

The following table describes the items in the previous figure.

Table 82: Management > LLDP > LLDP System Settings

Item	Description
Enabled	Click Enabled or Disabled to set the Global Settings state.
LLDP PDU Disable Action	Click to select the LLDP PDU handling action when LLDP is globally disabled. Options include: Filtered, Bridged, or Flooded.
Transmission Interval	Select the interval at which frames are transmitted. The default is 30 seconds, and the valid range is 5 to 32768 seconds.
Holdtime Multiplier	Select the multiplier on the transmit interval to assign to TTL.
Reinitialization Delay	Select the delay length before re-initialization.
Transmit Delay	Select the delay after an LLDP frame is sent.
Apply	Click Apply to save the values and update the screen.

The ensuing table for **LLDP Global Config** settings are informational only: LLDP Enabled, LLDP PDU Disable Action, Transmission Interval, Holdtime Multiplier, Reinitialization Delay and Transmit Delay.

LLDP Port Settings

The LLDP Port Settings page allows you to configure the state (enabled or disabled) of the selected port.

To access this page, click **Management > LLDP > LLDP Port Settings**.



Figure 101: Management > LLDP > LLDP Port Settings > LLDP Port Configuration

The following table describes the items in the previous figure.

Table 83: Management > LLDP > LLDP Port Settings > LLDP Port Configuration

Item	Description
Port Select	Enter the port number associated with the LLDP setting.
State	Click the drop-down menu to select the LLDP port state.
Apply	Click Apply to save the values and update the screen.



Figure 102: Management > LLDP > LLDP Port Settings > Optional TLVs Selection

The following table describes the items in the previous figure.

Table 84: Management > LLDP > LLDP Port Settings > Optional TLVs Selection

Item	Description
Port Select	Enter the port number associated with the TLV (optional) selection.
Optional TLV Select	Click the drop-down menu to select the LLDP optional TLVs to be carried (multiple selections are allowed). <ul style="list-style-type: none"> ■ System Name: To include system name TLV in LLDP frames. ■ Port Description: To include port description TLV in LLDP frames. ■ System Description: To include system description TLV in LLDP frames. ■ System Capability: To include system capability TLV in LLDP frames. ■ 802.3 MAC-PHY: ■ 802.3 Link Aggregation: ■ 802.3 Maximum Frame Size: ■ Management Address: ■ 802.1 PVID:
Apply	Click Apply to save the values and update the screen.

The ensuing table for **LLDP Port Status** settings are informational only: Port, State and Selected Optional TLVs.

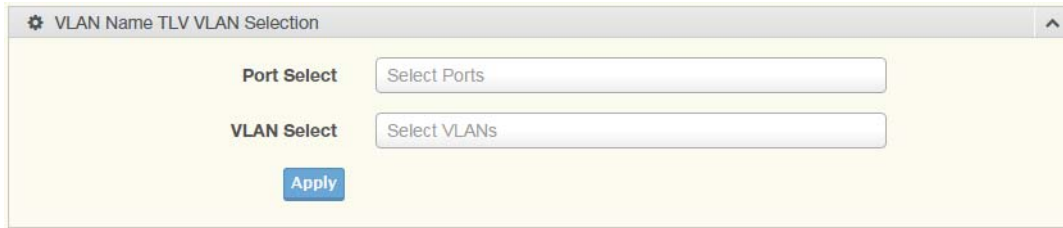

Figure 103: Management > LLDP > LLDP Port Settings > VLAN Name TLV VLAN Selection

The following table describes the items in the previous figure.

Table 85: Management > LLDP > LLDP Port Settings > VLAN Name TLV VLAN Selection

Item	Description
Port Select	Enter the port number to associated with the TLV selection.
VLAN Select	Select the VLAN Name ID to be carried out (multiple selection is allowed).
Apply	Click Apply to save the values and update the screen.

The ensuing table for **LLDP Port VLAN TLV Status** settings are informational only: Port and Selected VLAN.

LLDP Local Device Info

The LLDP Local Device Info page allows you to view information regarding network devices, providing that the switch has already obtained LLDP information on the devices.

To access this page, click **Management > LLDP > LLDP Local Device Info**.

The ensuing table for **Local Device Summary** settings are informational only: Chassis ID Subtype, Chassis ID, System Name, System Description, Capabilities Supported, Capabilities Enabled and Port ID Subtype.

The ensuing table for **Port Status** settings are informational only: Port, Selected VLAN and **Detail** (click the radio box and click **Detail** to displays the details).

LLDP Remote Device Info

The LLDP Remote Device Info page allows you to view information about remote devices, LLDP information must be available on the switch.

To access this page, click **Management > LLDP > LLDP Remote Device Info**.



Figure 104: Management > LLDP > LLDP Remote Device Info

The following table describes the items in the previous figure.

Table 86: Management > LLDP > LLDP Remote Device Info

Item	Description
Detail	Click to display the device details.
Delete	Click to delete the selected devices.
Refresh	Click to refresh the remote device information list.

LLDP Overloading

To access this page, click **Management > LLDP > LLDP Overloading**.

The ensuing table for **LLDP Overloading** settings are informational only: Port, Total (Bytes), Left to Send (Bytes), Status and Status (Mandatory TLVs, 802.3 TLVs, Optional TLVs and 802.1 TLVs).

SNMP

Simple Network Management Protocol (SNMP) is a protocol to facilitate the monitoring and exchange of management information between network devices. Through SNMP, the health of the network or status of a particular device can be determined.

SNMP Settings

The SNMP Settings page allows you to set the SNMP daemon state (enabled or disabled).

To access this page, click **Management > SNMP > SNMP Settings**.



Figure 105: Management > SNMP > SNMP Settings

The following table describes the items in the previous figure.

Table 87: Management > SNMP > SNMP Settings

Item	Description
State	Click Enabled or Disabled to define the SNMP daemon.
Apply	Click Apply to save the values and update the screen.

The ensuing table for **SNMP Information** settings are informational only: SNMP.

SNMP Community

The SNMP Community page provides configuration options for the community.

SNMP v1 and SNMP v2c use the group name (Community Name) certification. It's role is similar to the password function. If SNMP v1 and SNMP v2c are used, you can go directly from the configuration settings to this page to configure the SNMP community.

To access this page, click **Management > SNMP > SNMP Community**.



Figure 106: Management > SNMP > SNMP Community

The following table describes the items in the previous figure.

Table 88: Management > SNMP > SNMP Community

Item	Description
Community Name	Enter a community name (up to 20 characters).
Access Right	Click the radio box to specify the access level (read only or read write).
Apply	Click Apply to save the values and update the screen.

The ensuing table for **Community Status** settings are informational only: No., Community Name, Access Right and **Delete** (click to delete the desired community name).

SNMP User Settings

The SNMP User Settings page allows you to create SNMP groups. The users have the same level of security and access control permissions as defined by the group settings.

To access this page, click **Management > SNMP > SNMP User Settings**.

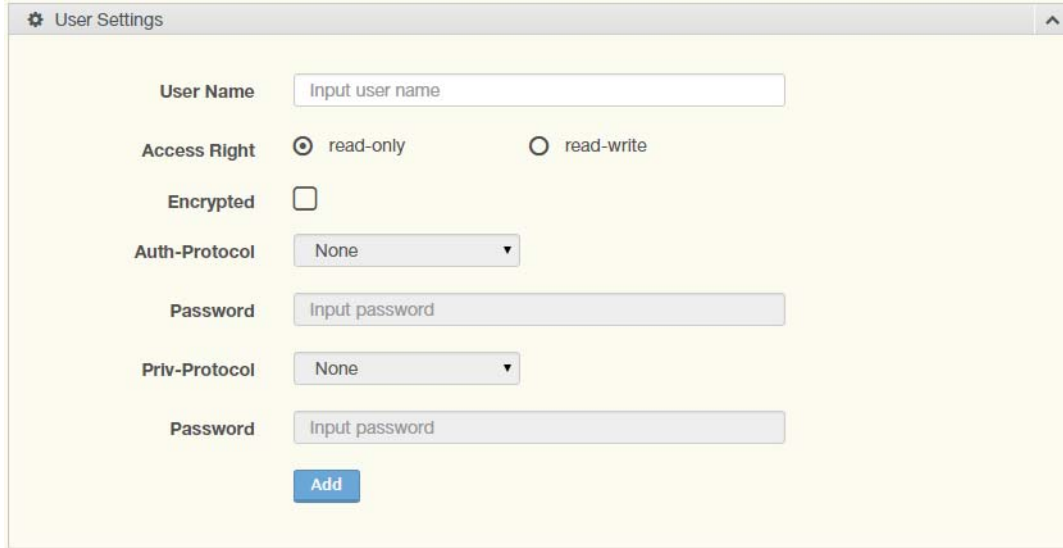

Figure 107: Management > SNMP > SNMP User Settings

The following table describes the items in the previous figure.

Table 89: Management > SNMP > SNMP User Settings

Item	Description
User Name	Enter a user name (up to 32 characters) to create an SNMP profile.
Access Right	Click read-only or read-write to define the access right for the profile.
Encrypted	Click the option to set the encrypted option for the user setting.
Auth-Protocol	Click the drop-down menu to select the authentication level: MD5 or SHA. The field requires a user password. <ul style="list-style-type: none"> ■ MD5: specify HMAC-MD5-96 authentication level ■ SHA: specify HMAC-SHA authentication protocol
Password	Enter the characters to define the password associated with the authentication protocol.
Priv-Protocol	Click the drop-down menu to select an authorization protocol: none or DES. The field requires a user password. <ul style="list-style-type: none"> ■ None: no authorization protocol in use ■ DES: specify 56-bit encryption in use
Password	Enter the characters to define the password associated with the authorization protocol.
Add	Click Add to save the values and update the screen.

The ensuing table for **User Status** settings are informational only: User Name, Access Right, Auth-Protocol, Priv-Protocol and **Delete** (click to delete the desired user name).

SNMP Trap

The SNMP Trap page allows you to set the IP address of the node and the SNMP credentials corresponding to the version that is included in the trap message.

To access this page, click **Management > SNMP > SNMP Trap**.



Figure 108: Management > SNMP > SNMP Trap

The following table describes the items in the previous figure.

Table 90: Management > SNMP > SNMP Trap

Item	Description
IP Address	Enter the IP address to designate the SNMP trap host.
Community Name	Click the drop-down menu to select a defined community name.
Version	Click the drop-down menu to designate the SNMP version credentials (v1 or v2c).
Add	Click Add to save the values and update the screen.

The ensuing table for **Trap Host Status** settings are informational only: No., IP Address, Community Name, Version and **Delete** (click to delete the desired IP address).

Diagnostics

Through the Diagnostics function configuration of settings for the switch diagnostics is available.

Cable Diagnostics

The Cable Diagnostics page allows you to select the port for applying a copper test.

To access this page, click **Diagnostics > Cable Diagnostics**.



Figure 109: Diagnostics > Cable Diagnostics

The following table describes the items in the previous figure.

Table 91: Diagnostics > Cable Diagnostics

Item	Description
Port	Click the drop-down menu to select a pre-defined port for diagnostic testing. Giga ports are displayed with a channel A to D designation.
Copper Test	Click Copper Test to display the test result for the selected port.

The ensuing table for **Test Result** settings are informational only: Port, Channel A, Cable Length A, Channel B, Cable Length B, Channel C, Cable Length C, Channel D and Cable Length D.

Ping Test

The Ping Test page allows you to configure the test log page.

To access this page, click **Diagnostics > Ping Test**.

Figure 110: Diagnostics > Ping Test

The following table describes the items in the previous figure.

Table 92: Diagnostics > Ping Test

Item	Description
IP Address	Enter the IP address or host name of the station to ping. The initial value is blank. The IP Address or host name you enter is not retained across a power cycle. Host names are composed of series of labels concatenated with periods. Each label must be between 1 and 63 characters long, maximum of 64 characters.
Count	Enter the number of echo requests to send. The default value is 4. The value ranges from 1 to 5. The count entered is not retained across a power cycle.
Interval (in sec)	Enter the interval between ping packets in seconds. The default value is 1. The value ranges from 1 to 5. The interval entered is not retained across a power cycle.
Size (in bytes)	Enter the size of ping packet. The default value is 56. The value ranges from 8 to 5120. The size entered is not retained across a power cycle.
Ping Results	Display the ping reply format.
Apply	Click Apply to display ping result for the IP address.

IPv6 Ping Test

The IPv6 Ping Test page allows you to configure the Ping Test for IPv6.

To access this page, click **Diagnostics > IPv6 Ping Test**.

Figure 111: Diagnostics > IPv6 Ping Test

The following table describes the items in the previous figure.

Table 93: Diagnostics > IPv6 Ping Test

Item	Description
IPv6 Address	Enter the IP address or host name of the station you want the switch to ping. The initial value is blank. The IP Address or host name you enter is not retained across a power cycle. Host names are composed of series of labels concatenated with dots. Each label must be between 1 and 63 characters long, and the entire hostname has a maximum of 64 characters.
Count	Enter the number of echo requests you want to send. The default value is 4. The value ranges from 1 to 5. The count you enter is not retained across a power cycle.
Interval (in sec)	Enter the interval between ping packets in seconds. The default value is 1. The value ranges from 1 to 5. The interval you enter is not retained across a power cycle.
Size (in bytes)	Enter the size of ping packet. The default value is 56. The value ranges from 8 to 5120. The size you enter is not retained across a power cycle.

Table 93: Diagnostics > IPv6 Ping Test (Continued)

Item	Description
Ping Results	Display the ping reply format. PING 2222::777 (2222::777): 56 data bytes --- 2222::777 ping statistics --- 4 packets transmitted, 0 packets received, 100% packet loss Or PING 2222::717 (2222::717): 56 data bytes 64 bytes from 2222::717: icmp6_seq=0 ttl=128 time=10.0 ms 64 bytes from 2222::717: icmp6_seq=1 ttl=128 time=0.0 ms 64 bytes from 2222::717: icmp6_seq=2 ttl=128 time=0.0 ms 64 bytes from 2222::717: icmp6_seq=3 ttl=128 time=0.0 ms --- 2222::717 ping statistics --- 4 packets transmitted, 4 packets received, 0% packet loss round-trip min/avg/max = 0.0/2.5/10.0 ms
Apply	Click Apply to display ping result for the IP address.

System Log

Logging Service

The Logging Service page allows you to set up the logging services feature for the system log.

To access this page, click **Diagnostics > System Log > Logging Service**.

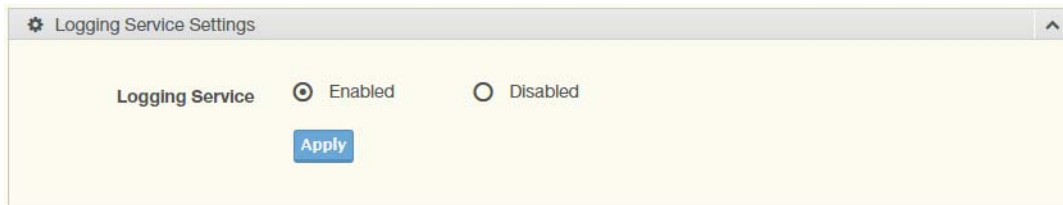

Figure 112: Diagnostics > System Log > Logging Service

The following table describes the items in the previous figure.

Table 94: Diagnostics > System Log > Logging Service

Item	Description
Logging Service	Click Enabled or Disabled to set the Logging Service status.
Apply	Click Apply to save the values and update the screen.

The ensuing table for **Logging Information** settings are informational only: Logging Service.

Local Logging

The Local Logging page allows you to designate a local target when the severity criteria is reached.

To access this page, click **Diagnostics > System Log > Local Logging**.

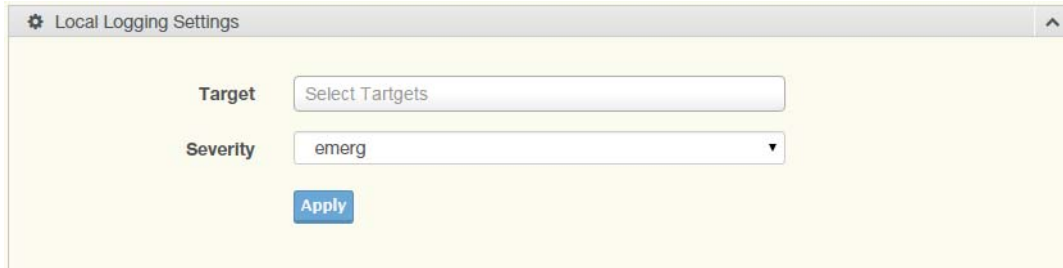

Figure 113: Diagnostics > System Log > Local Logging

The following table describes the items in the previous figure.

Table 95: Diagnostics > System Log > Local Logging

Item	Description
Target	Enter the local logging target.
Severity	Click the drop-down menu to select the severity level for local log messages. The level options are: <ul style="list-style-type: none"> ■ emerg: Indicates system is unusable. It is the highest level of severity ■ alert: Indicates action must be taken immediately ■ crit: Indicates critical conditions ■ error: Indicates error conditions ■ warning: Indicates warning conditions ■ notice: Indicates normal but significant conditions ■ info: Indicates informational messages ■ debug: Indicates debug-level messages
Apply	Click Apply to save the values and update the screen.

The ensuing table for **Local Logging Settings Status** settings are informational only: Status, Target, Severity and **Delete** (click to delete the desired target).

System Log Server

The System Log Server page allows you to configure the log server.

To access this page, click **Diagnostics > System Log > System Log Server**.

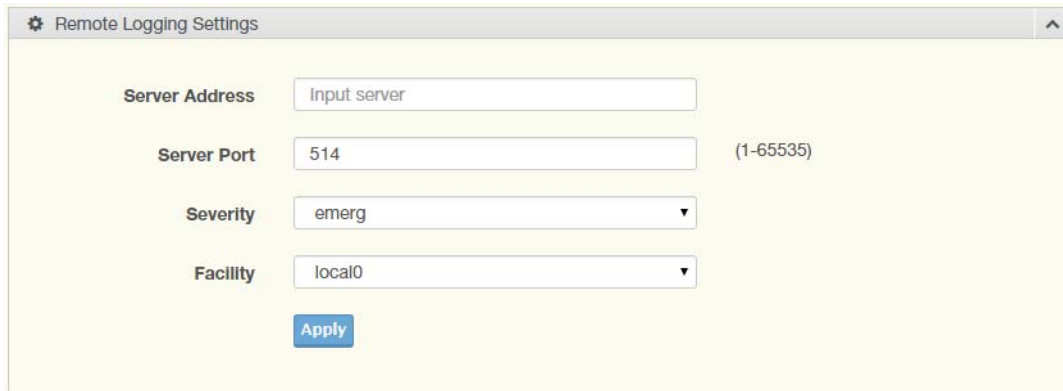

Figure 114: Diagnostics > System Log > System Log Server

The following table describes the items in the previous figure.

Table 96: Diagnostics > System Log > System Log Server

Item	Description
Server Address	Enter the IP address of the log server.
Server Port	Enter the Udp port number of the log server.
Severity	Click the drop-down menu to select the severity level for local log messages. The default is emerg. The level options are: <ul style="list-style-type: none"> ■ emerg: Indicates system is unusable. It is the highest level of severity ■ alert: Indicates action must be taken immediately ■ crit: Indicates critical conditions ■ error: Indicates error conditions ■ warning: Indicates warning conditions ■ notice: Indicates normal but significant conditions ■ info: Indicates informational messages ■ debug: Indicates debug-level messages
Facility	Click the drop-down menu to select facility to which the message refers.
Apply	Click Apply to save the values and update the screen.

The ensuing table for **Remote Logging Setting Status** settings are informational only: Status, Server Info, Severity, Facility and **Delete** (click to delete the desired server address).

DDM

The DDM page allows you to set up the diagnostic alarm status.

To access this page, click **Diagnostics > DDM**.



Figure 115: Diagnostics > DDM

The following table describes the items in the previous figure.

Table 97: Diagnostics > DDM

Item	Description
Diagnostic Alarm	Click the drop-down menu to designate the announcement method: Disabled, SysLog, E-mail, or SNMP.
Apply	Click Apply to save the values and update the screen.

The ensuing table for **Diagnostic Alarm Information** settings are informational only: Diagnostic Alarm.

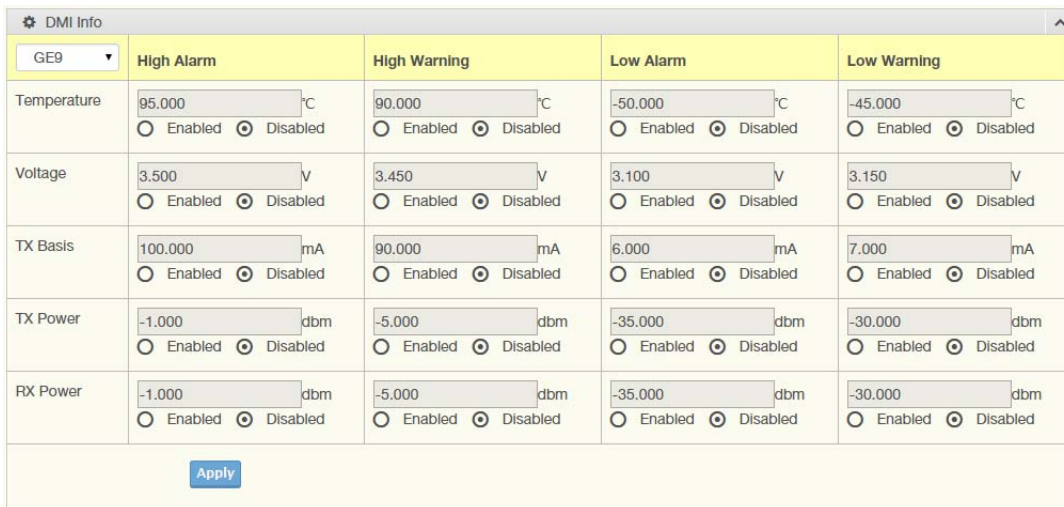

Figure 116: Diagnostics > DDM > Diagnostic Alarm Information

The following table describes the items in the previous figure.

Table 98: Diagnostics > DDM > Diagnostic Alarm Information

Item	Description
High Alarm	Click Enabled or Disabled to set the alarm state.
High Warning	Click Enabled or Disabled to set the alarm state.
Low Alarm	Click Enabled or Disabled to set the alarm state.
Low Warning	Click Enabled or Disabled to set the alarm state.
Apply	Click Apply to save the values and update the screen.

The ensuing table for **Vendor Info** settings are informational only: **Refresh** (click to reload the vendor information), Port, Connector, Speed, VendorName, VendorOui, VendorPn, VendorRev, VendorSn and DateCode.

Tools

IXM

The IXM tool is an industrial Ethernet switch solution to help the users deploy industrial Ethernet switch hardware by allowing users with multiple, managed Ethernet switches in the field to eliminate the need to individually connect to each device to configure it.

To access this page, click **Tools** > **IXM**.

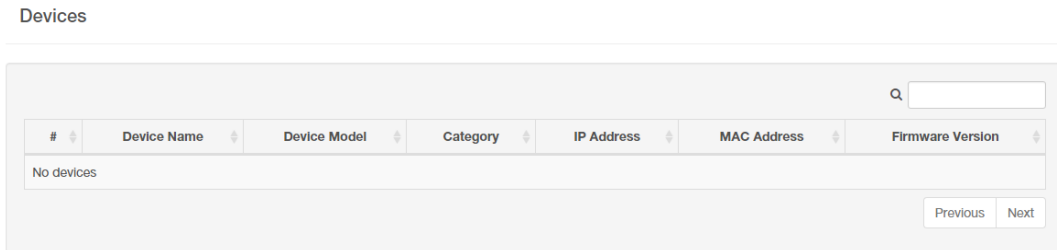

Figure 117: Tools > IXM

The following table describes the items in the previous figure.

Table 99: Tools > IXM

Item	Description
Search Field	Enter criteria to search the IXM information.
#	Displays the reference to the device number.
Device Name	Displays the device name.
Device Model	Displays the device model type.
Category	Displays the device's category type.
IP Address	Displays the device's IP address.
MAC Address	Displays the device's IP MAC address.
Firmware Version	Displays the device's firmware version.
Previous	Click Previous to back to previous page.
Next	Click Next to go to next page.

Backup Manager

The Backup Manager page allows you to configure a remote TFTP sever or host file system in order to backup the firmware image or configuration file.

To access this page, click **Tools > Backup Manager**.

Figure 118: Tools > Backup Manager

The following table describes the items in the previous figure.

Table 100: Tools > Backup Manager

Item	Description
Backup Method	Click the drop-down menu to select the backup method: TFTP or HTTP.
Server IP	Enter the IP address of the backup server.
Backup Type	Click a type to define the backup method: image: running configuration, startup configuration, or buffered log.
Image	Choose the image to backup.
Backup	Click Backup to backup the settings.

Upgrade Manager

The Upgrade Manager page allows you to configure a remote TFTP sever or host file system in order to upload firmware upgrade images or configuration files.

To access this page, click **Tools > Upgrade Manager**.

Figure 119: Tools > Upgrade Manager

The following table describes the items in the previous figure.

Table 101: Tools > Upgrade Manager

Item	Description
Upgrade Method	Click the drop-down menu to select the upgrade method: TFTP or HTTP.
Server IP	Enter the IP address of the upgrade server.
File Name	Enter the file name of the new firmware version.
Upgrade Type	Click a type to define the upgrade method: image, startup configuration, or running configuration.
Image	Choose the image to upgrade.
Upgrade	Click Upgrade to upgrade to the current version.

Dual Image

The Dual Image page allows you to set up an active and backup partitions for firmware image redundancy.

To access this page, click **Tools > Dual Image**.



Figure 120: Tools > Dual Image

The following table describes the items in the previous figure.

Table 102: Tools > Dual Image

Item	Description
Active Image	Click the format for the image type: Partition0 (Active) or Partition1 (backup).
Save	Click Save to save and keep the new settings.

The ensuing table for **Image Information 0/1** settings are informational only: Flash Partition, Image Name, Image Size and Created Time.

Save Configuration

To access this page, click **Tools > Save Configuration**.

Click **Save Configuration to FLASH** to have configuration changes you have made to be saved across a system reboot. All changes submitted since the previous save or system reboot will be retained by the switch.

User Account

The User Account page allows you to set up a user and the related parameters. To access this page, click **Tools > User Account**.

Figure 121: Tools > User Account

The following table describes the items in the previous figure.

Table 103: Tools > User Account

Item	Description
User Name	Enter the name of the new user entry.
Password Type	Click the drop-down menu to define the type of password: Clear Text , Encrypted or No Password .
Password	Enter the character set for the define password type.
Retype Password	Retype the password entry to confirm the profile password.
Privilege Type	Click the drop-down menu to designate privilege authority for the user entry: Admin or User .
Apply	Click Apply to create a new user account.

The ensuing table for **Local Users** settings are informational only: User Name, Password Type, Privilege Type and **Delete** (click to delete the desired user account).

Reset System

To access this page, click **Tools > Reset System**.

Click **Restore** to have all configuration parameters reset to their factory default values. All changes that have been made will be lost, even if you have issued a save.

Reset settings take effect after a system reboot.

Reboot Device

To access this page, click **Tools > Reboot Device**.

Click **Reboot** to reboot the switch. Any configuration changes you have made since the last time you issued a save will be lost.

TROUBLESHOOTING

Verify that you are using the right power cord/adaptor (DC 12-48V), please don't use the power adapter with DC output higher than 48V, or it may damage this device.

Select the proper UTP/STP cable to construct the user network. Use unshielded twisted-pair (UTP) or shield twisted-pair (STP) cable for RJ-45 connections that depend on the connector type the switch equipped: 100R Category 3, 4 or 5 cable for 10Mbps connections, 100R Category 5 cable for 100Mbps connections, or 100R Category 5e/above cable for 1000Mbps connections. Also be sure that the length of any twisted-pair connection does not exceed 100 meters (328 feet).

R = replacement letter for Ohm symbol.

Diagnosing LED Indicators: To assist in identifying problems, the switch can be easily monitored through panel indicators, which describe common problems the user may encounter and where the user can find possible solutions.

If the power indicator does not light on when the power cord is plugged in, you may have a problem with power cord. Then check for loose power connections, power losses or surges at power outlet. If you still cannot resolve the problem, contact the local dealer for assistance.

If the LED indicators are normal and the connected cables are correct but the packets still cannot be transmitted. Please check the user system's Ethernet devices' configuration or status.

ADVANTECH B+B SMARTWORX TECHNICAL SUPPORT

Phone: 1-800-346-3119
(Monday - Friday, 7 a.m. to 5:30 p.m. CST)

Fax: 815-433-5109

Email: support@advantech-bb.com

Web: www.advantech-bb.com