



Noise Suppression Sheets

Flexield

IFL series

Noise Suppression Sheets

Product compatible with RoHS directive
Halogen-free

Flexield

Overview of IFL series

FEATURES

- Multiple high permeability materials to choose from based on application
- Multiple thickness to meet performance requirements
- High flexibility which allows sheets to easily be formed to desired shape
- Non conductive film which can be attached directly to circuit components
- Provide attenuation up to the 1-3 GHz range
- Available on a roll or in sheet form

APPLICATION

- General EMI attenuation on various types of electronic equipment
- LED/LCD display address and data lined/traces/cables
- Stylus pens for improved sensitivity
- Sensors shielding and immunity
- Digital audio and video lines

STANDARD SHAPE LIST

Material name	Magnetic layer thickness (mm)	Sheet dimensions (mm)	Roll dimensions	
			Width (mm)	Length (m)
IFL10M	0.025	300X200	300	100
	0.050			
	0.100		Non-STD*	Non-STD*
	0.200			
IFL12	0.050	300X200	300	100
	0.100			
	0.200			
IFL16	0.030	300X200	300	100
	0.050			
	0.100		Non-STD*	Non-STD*

* Please contact us for details

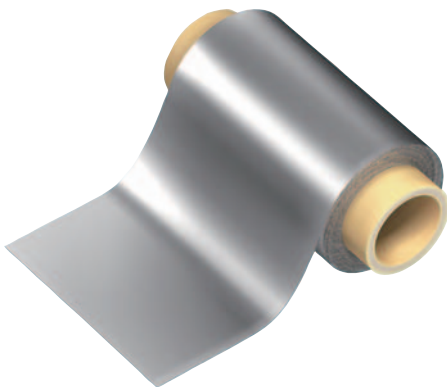

- RoHS Directive Compliant Product: See the following for more details. <https://product.tdk.com/info/en/environment/rohs/index.html>
- Halogen-free: Indicates that Cl content is less than 900ppm, Br content is less than 900ppm, and that the total Cl and Br content is less than 1500ppm.

 Please be sure to request delivery specifications that provide further details on the features and specifications of the products for proper and safe use. Please note that the contents may change without any prior notice due to reasons such as upgrading.

IFL series Sheet Type

■ PART NUMBER CONSTRUCTION

IFL	10M	-	050	N	B	300	×	200	
Series name	Material symbol	Magnetic layer thickness (mm)		Top surface layer thickness (mm)		Double-sided adhesive tape thickness (mm)		Length (mm)	Width (mm)
IFL	10M	025	0.025	N	No	N	No	300	200
	12	030	0.030	P	0.016	B	0.010	300	200
	16	050	0.050	R	0.038	D	0.030	300	200
		100	0.100	R: Release type					
		200	0.200						

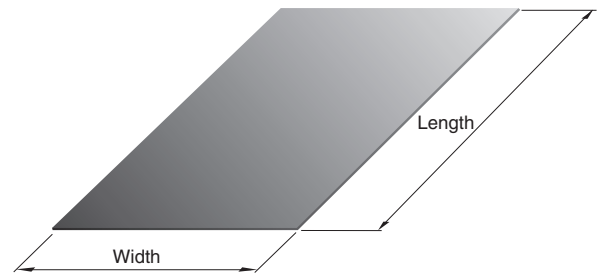
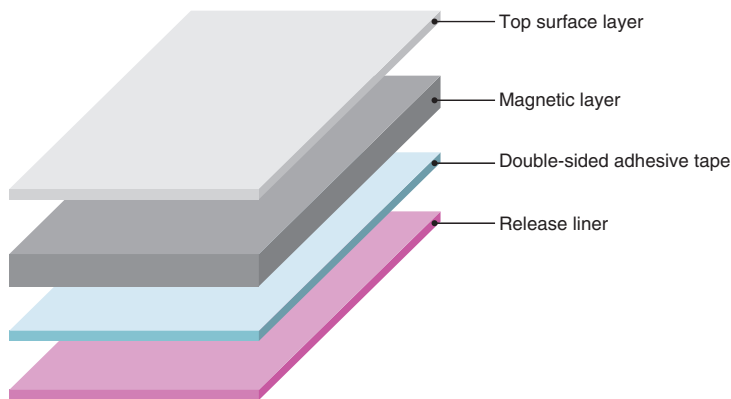

■ STANDARD PART NUMBER LIST

Material name	Sheet dimensions (mm)	Magnetic layer thickness (mm)	Total thickness (mm)typ.	Part number
IFL10M	300X200	0.025	0.035	IFL10M-025NB300X200
		0.050	0.060	IFL10M-050NB300X200
		0.100	0.110	IFL10M-100NB300X200
		0.200	0.240	IFL10M-200ND300X200
IFL12	300X200	0.050	0.060	IFL12-050NB300X200
		0.100	0.110	IFL12-100NB300X200
		0.200	0.240	IFL12-200ND300X200
IFL16	300X200	0.030	0.040	IFL16-030NB300X200
		0.050	0.060	IFL16-050NB300X200
		0.100	0.110	IFL16-100NB300X200

IFL series Roll Type

■ PART NUMBER CONSTRUCTION

IFL	10M	-	025	N	B	1HR	×	300	
Series name	Material symbol	Magnetic layer thickness (mm)		Top surface layer thickness (mm)		Double-sided adhesive tape thickness (mm)		Length (m)	Width (mm)
IFL	10M	025	0.025	N	No	N	No	1HR	100
	12	030	0.030	P	0.016	B	0.010		300
	16	050	0.050	R	0.038	D	0.030		300
		100	0.100	R: Release type					
		200	0.200						

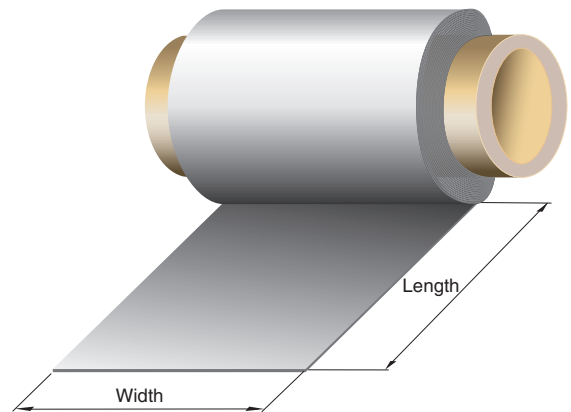
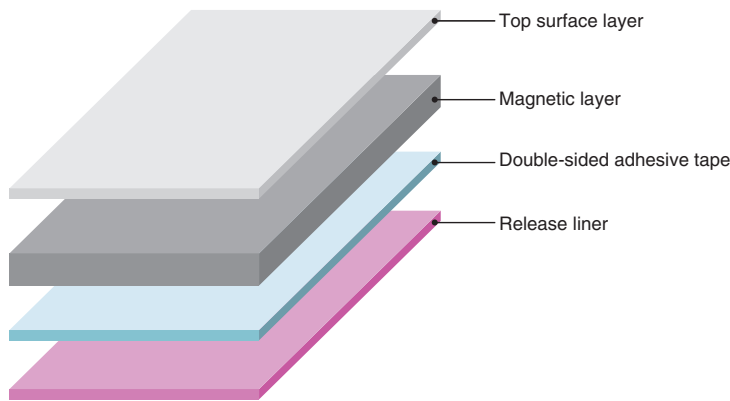

■ STANDARD PART NUMBER LIST

Material name	Roll dimensions		Magnetic layer thickness (mm)	Total thickness (mm)typ.	Part number
	Width (mm)	Length (m)			
IFL10M	300	100	0.025	0.063*	IFL10M-025RN1HRX300
			0.050	0.088*	IFL10M-050RN1HRX300
			0.100	0.138*	IFL10M-100RN1HRX300
			0.025	0.035	IFL10M-025NB1HRX300
			0.050	0.060	IFL10M-050NB1HRX300
			0.100	0.110	IFL10M-100NB1HRX300
IFL12	300	100	0.050	0.088*	IFL12-050RN1HRX300
			0.100	0.138*	IFL12-100RN1HRX300
			0.050	0.060	IFL12-050NB1HRX300
			0.100	0.110	IFL12-100NB1HRX300
IFL16	300	100	0.030	0.068*	IFL16-030RN1HRX300
			0.050	0.088*	IFL16-050RN1HRX300
			0.100	0.138*	IFL16-100RN1HRX300
			0.030	0.040	IFL16-030NB1HRX300
			0.050	0.060	IFL16-050NB1HRX300

* Note : Including top surface layer

IFL series

MATERIAL CHARACTERISTIC

MATERIAL CHARACTERISTIC SPECIFICATION TABLE

Material name	Recommended specification frequency range	Relative permeability				Surface resistivity ($\Omega/\text{sq.}$)typ.	Thermal conductivity (W/m · K)	Saturated magnetic flux density (mT)	Curie temperature (°C)	Relative Permittivity (at 1MHz)typ.	Operating temperature (°C)
		[at 1MHz] u'	u''	[at 13.56MHz] u'	u''						
IFL10M	10MHz to 3GHz	120	< 1	100	30	1M	1.5	150 [H=1194A/m]	>500	1600	-40 to +85
IFL12	5MHz to 3GHz	180	< 1	115	40	10k	1.5	180 [H=1194A/m]	>500	1600	-40 to +85
IFL16	0.5MHz to 1GHz	220	< 1	140	60	10k	1.5	230 [H=1194A/m]	>500	1700	-40 to +85

RELATIVE PERMEABILITY

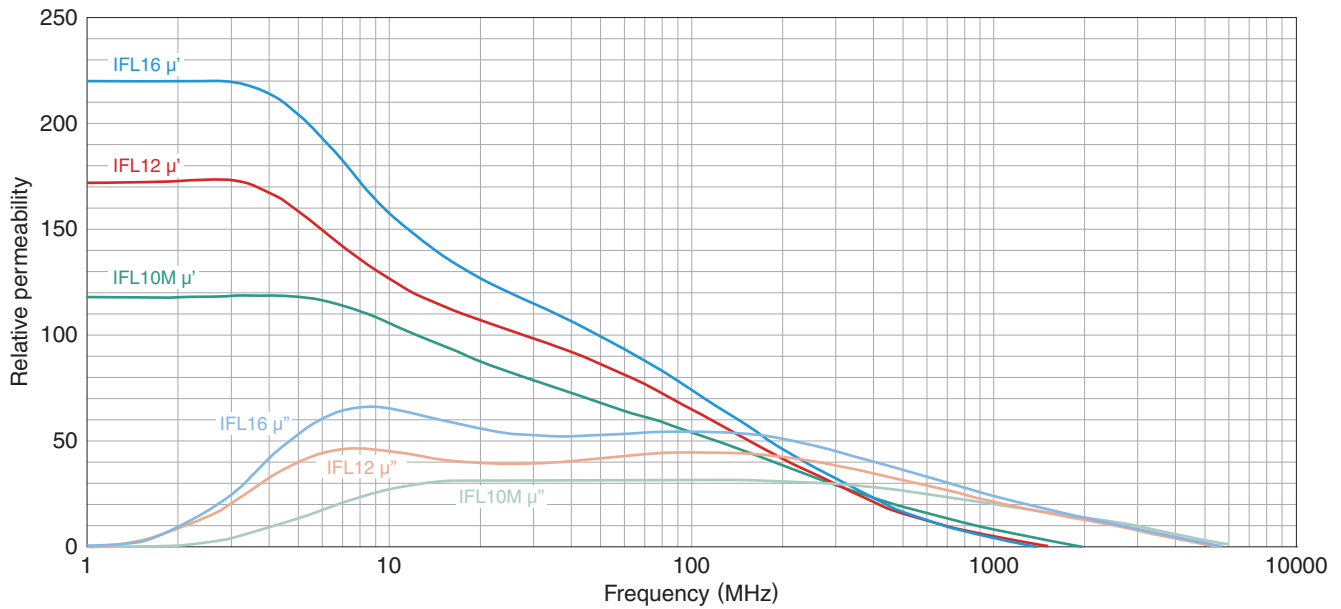

IFL series

MATERIAL CHARACTERISTIC

SHIELDING EFFECTIVENESS (Up to 100MHz)

IFL10M

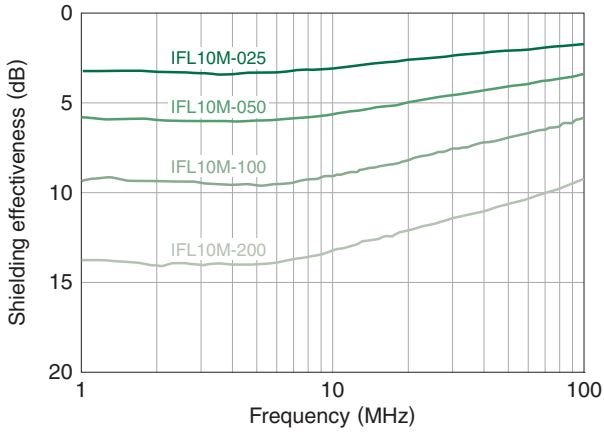

IFL12

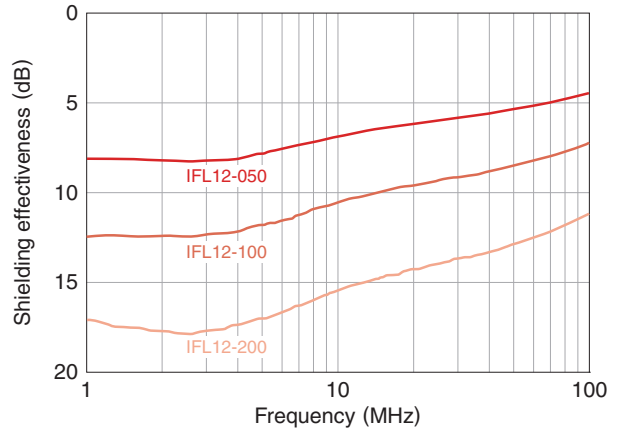

IFL16

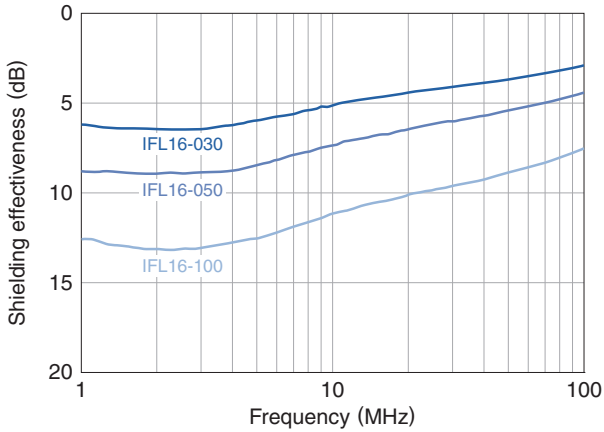

MEASUREMENT SETUP (Up to 100MHz)

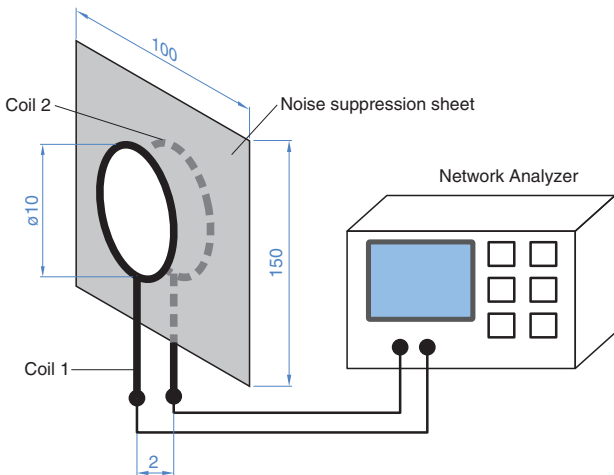

 Please be sure to request delivery specifications that provide further details on the features and specifications of the products for proper and safe use. Please note that the contents may change without any prior notice due to reasons such as upgrading.

IFL series

MATERIAL CHARACTERISTIC

SHIELDING EFFECTIVENESS (100MHz to 6GHz) *

* Note that there is no continuity with data below 100 MHz. Since the gap between the coils is shortened, the gain is a little increased.

IFL10M

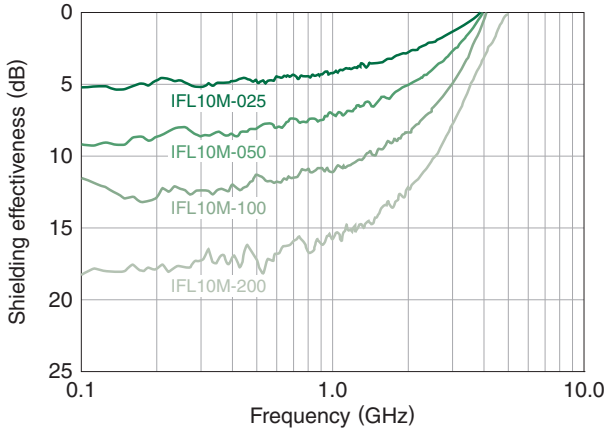

IFL12

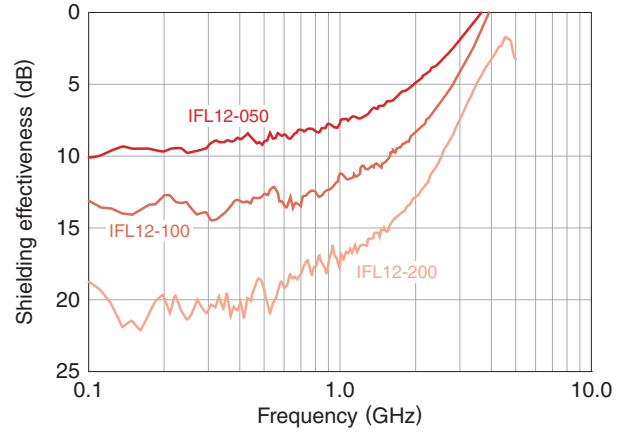

IFL16

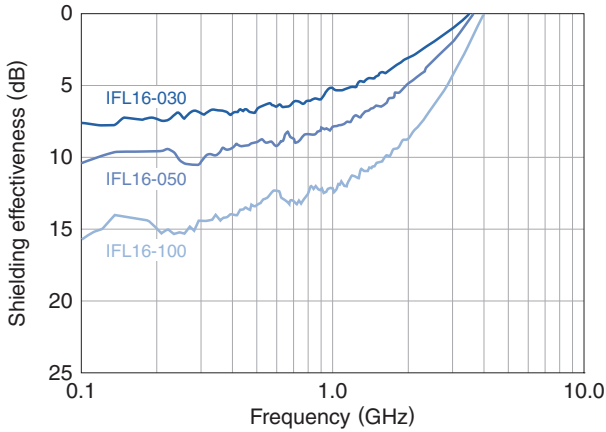

MEASUREMENT SETUP (100MHz to 6GHz)

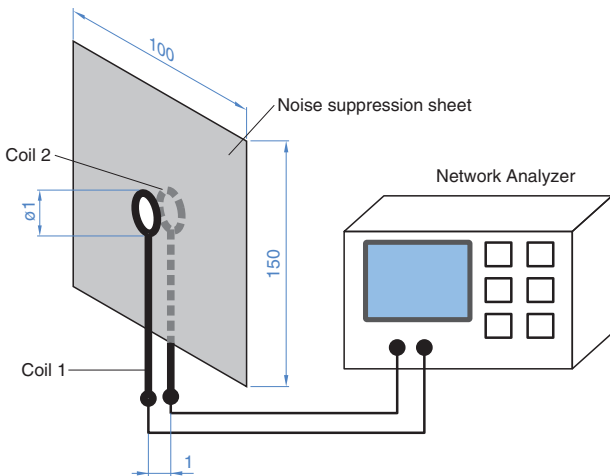

⚠ Please be sure to request delivery specifications that provide further details on the features and specifications of the products for proper and safe use. Please note that the contents may change without any prior notice due to reasons such as upgrading.

IFL series

MATERIAL CHARACTERISTIC

TRANSMISSION NOISE ATTENUATION

IFL10M

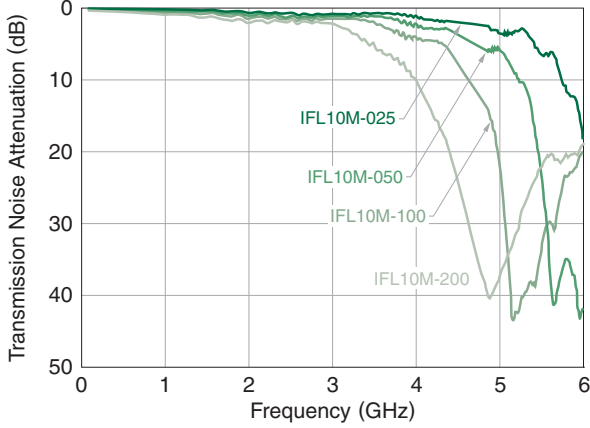

IFL12

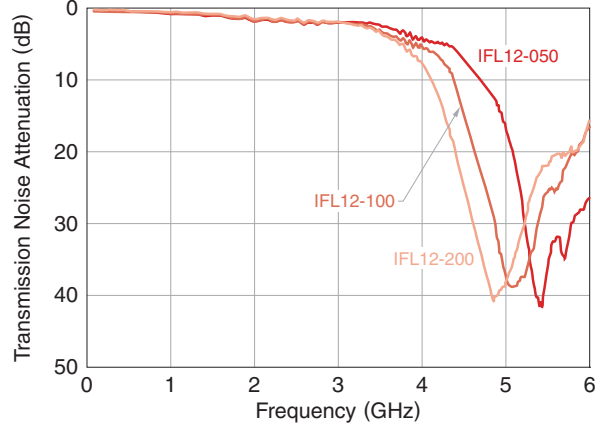

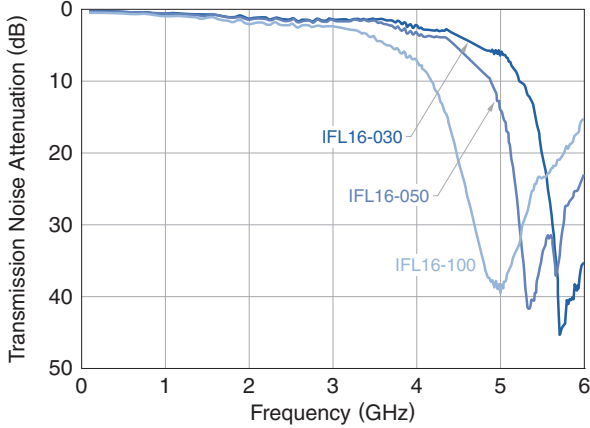

IFL16

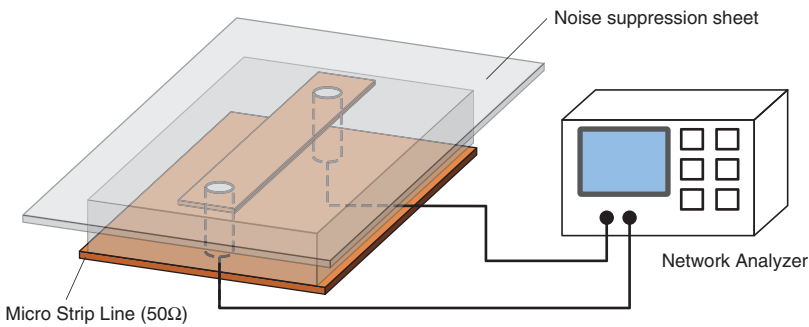

MEASUREMENT SETUP

NOTE : Refers to IEC62333-1,2 (Transmission Attenuation power ratio)



 Please be sure to request delivery specifications that provide further details on the features and specifications of the products for proper and safe use. Please note that the contents may change without any prior notice due to reasons such as upgrading.

REMINDERS FOR USING THESE PRODUCTS

Before using these products, be sure to request the delivery specifications.

SAFETY REMINDERS

Please pay sufficient attention to the warnings for safe designing when using these products.

REMINDERS

- The products listed on this catalog are intended for use in general electronic equipment (AV equipment, telecommunications equipment, home appliances, amusement equipment, computer equipment, personal equipment, office equipment, measurement equipment, industrial robots) under a normal operation and use condition.

The products are not designed or warranted to meet the requirements of the applications listed below, whose performance and/or quality require a more stringent level of safety or reliability, or whose failure, malfunction or trouble could cause serious damage to society, person or property.

If you intend to use the products in the applications listed below or if you have special requirements exceeding the range or conditions set forth in the each catalog, please contact us.

- | | |
|--------------------------------------------------------------------------------------|------------------------------------------------------------------------------|
| (1) Aerospace/aviation equipment | (8) Public information-processing equipment |
| (2) Transportation equipment (cars, electric trains, ships, etc.) | (9) Military equipment |
| (3) Medical equipment (excepting Pharmaceutical Affairs Law classification Class1,2) | (10) Electric heating apparatus, burning equipment |
| (4) Power-generation control equipment | (11) Disaster prevention/crime prevention equipment |
| (5) Atomic energy-related equipment | (12) Safety equipment |
| (6) Seabed equipment | (13) Other applications that are not considered general-purpose applications |
| (7) Transportation control equipment | |

When designing your equipment even for general-purpose applications, you are kindly requested to take into consideration securing protection circuit/device or providing backup circuits in your equipment.