

G3VM-61H1

MOS FET Relays

MOS FET Relays Designed for Switching Minute Signals and Analog Signals.



- Continuous load current of 400 mA.

RoHS compliant

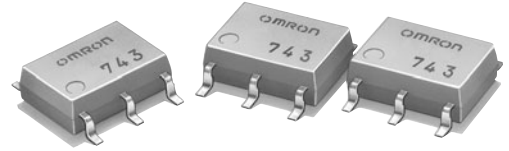

Note: The actual product is marked differently from the image shown here.

Application Examples

- Semiconductor test equipment
- Test & Measurement equipment
- Communication equipment
- Data loggers

Terminal Arrangement/Internal Connections

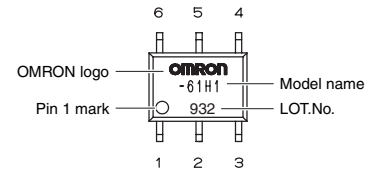
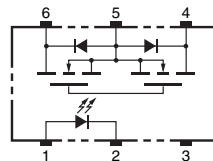

Note: The actual product is marked differently from the image shown here.

List of Models

Package type	Contact form	Terminals	Load voltage (peak value) *	Model	Minimum package quantity	
					Number per tube	Number per tape and reel
SOP6	1a (SPST-NO)	Surface-mounting Terminals	60 V	G3VM-61H1	75	-
				G3VM-61H1 (TR)	-	2,500

* The AC peak and DC value are given for the load voltage.

Absolute Maximum Ratings (Ta = 25°C)

Item		Symbol	Rating	Unit	Measurement conditions
Input	LED forward current	IF	50	mA	
	Repetitive peak LED forward current	IFP	1	A	100 μs pulses, 100 pps
	LED forward current reduction rate	ΔIF/°C	-0.5	mA/°C	Ta ≥ 25°C
	LED reverse voltage	VR	5	V	
Connection temperature		TJ	125	°C	
Load voltage (AC peak/DC)		V _{OFF}	60	V	
Output	Continuous load current	Connection A	400	mA	Connection A: AC peak/DC Connection B and C: DC
		Connection B	400		
		Connection C	800		
	ON current reduction rate	ΔIo/°C	-4.0	mA/°C	Ta ≥ 25°C
Connection temperature		TJ	125	°C	
Dielectric strength between I/O (See note 1.)		V _{I-O}	1500	V _{rms}	AC for 1 min
Ambient operating temperature		Ta	-40 to +85	°C	With no icing or condensation
Ambient storage temperature		Tstg	-55 to +125	°C	With no icing or condensation
Soldering temperature		-	260	°C	10 s

Note: 1. The dielectric strength between the input and output was checked by applying voltage between all pins as a group on the LED side and all pins as a group on the light-receiving side.

Connection Diagram

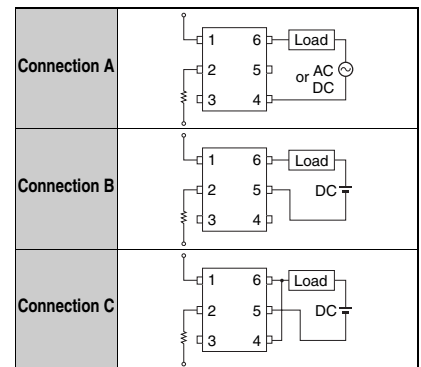

Electrical Characteristics (Ta = 25°C)

Item		Symbol	Minimum	Typical	Maximum	Unit	Measurement conditions
Input	LED forward voltage	V _F	1.0	1.15	1.3	V	IF = 10 mA
	Reverse current	IR	-	-	10	μA	VR = 5 V
	Capacity between terminals	C _T	-	30	-	pF	V = 0, f = 1 MHz
Trigger LED forward current		I _{FT}	-	1.6	3	mA	Io = 400 mA
Output	Maximum resistance with output ON	Connection A	-	1	2	Ω	IF = 5 mA, Io = 400 mA
		Connection B	-	0.5	1	Ω	IF = 5 mA, Io = 400 mA
		Connection C	-	0.25	-	Ω	IF = 5 mA, Io = 800 mA
	Current leakage when the relay is open	I _{LEAK}	-	-	1.0	μA	V _{OFF} = 60 V
Capacity between terminals		C _{off}	-	130	-	pF	V = 0, f = 1 MHz
Capacity between I/O terminals		C _{I-O}	-	0.8	-	pF	f = 1 MHz, Vs = 0 V
Insulation resistance between I/O terminals		R _{I-O}	1000	-	-	MΩ	V _{I-O} = 500 VDC, RoH ≤ 60 %
Turn-ON time		t _{ON}	-	0.8	2.0	ms	IF = 5 mA, RL = 200 Ω, V _{DD} = 20 V (See note 2.)
Turn-OFF time		t _{OFF}	-	0.1	0.5	ms	

Note: 2. Turn-ON and Turn-OFF Times

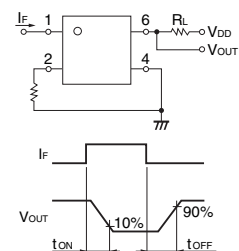

Recommended Operating Conditions

Use the G3VM under the following conditions so that the Relay will operate properly.

Item	Symbol	Minimum	Typical	Maximum	Unit
Load voltage (AC peak/DC)	V _{DD}	-	-	48	V
Operating LED forward current	I _F	5	7.5	25	mA
Continuous load current (AC peak/DC)	I _o	-	-	400	mA
Ambient operating temperature	T _a	-20	-	65	°C

Engineering Data

LED forward current vs. Ambient temperature

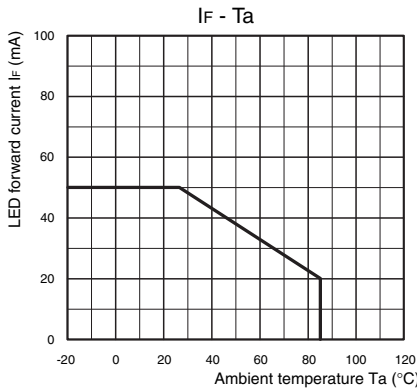

Continuous load current vs. Ambient temperature

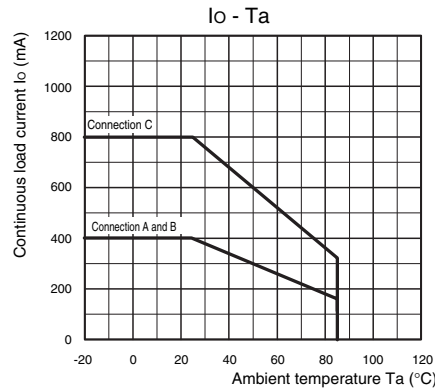

LED forward current vs. LED forward voltage

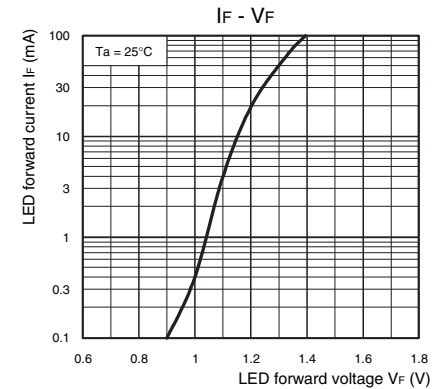

Continuous load current vs. On-state voltage

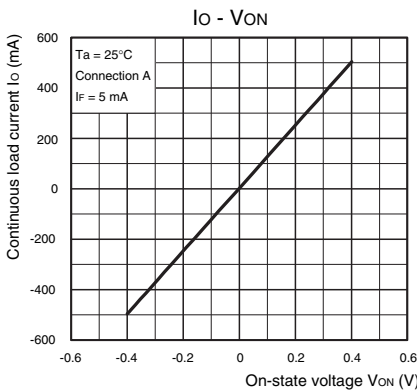

On-state resistance vs. Ambient temperature

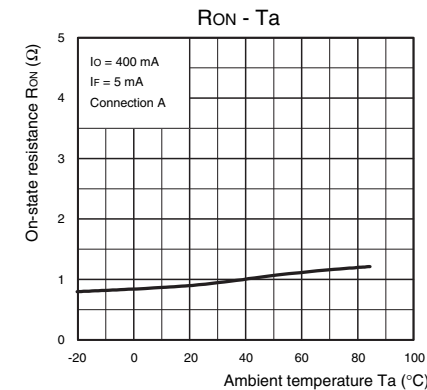

Trigger LED forward current vs. Ambient temperature

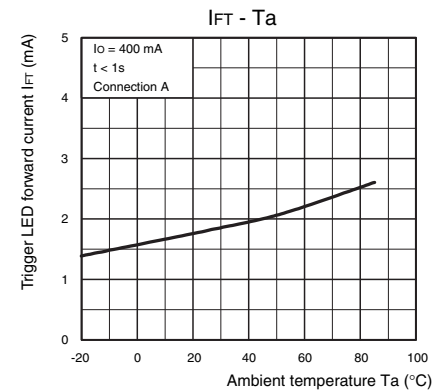

Turn ON, Turn OFF time vs. LED forward current

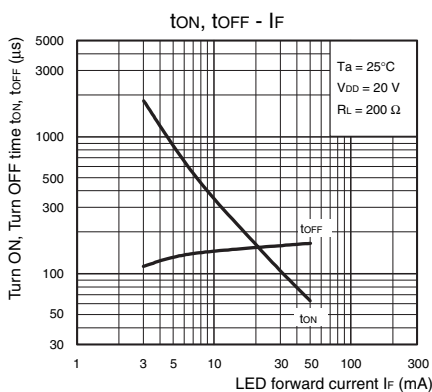

Turn ON, Turn OFF time vs. Ambient temperature

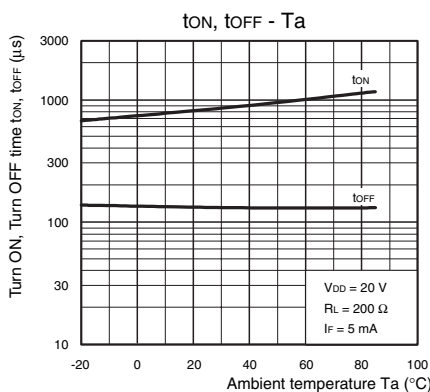

Current leakage vs. Ambient temperature

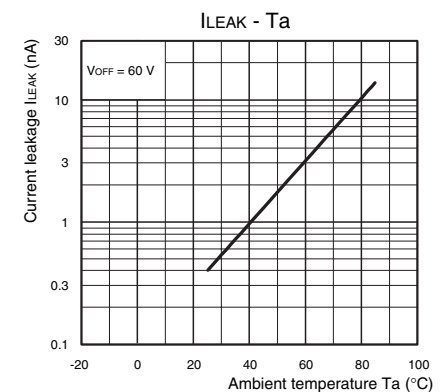

Safety Precautions

- Refer to "Common Precautions" for all G3VM models.

■ Appearance

SOP (Small Outline Package)

SOP6

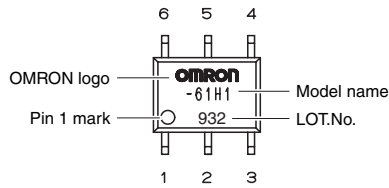

Note: The actual product is marked differently from the image shown here.

■ Dimensions

(Unit: mm)

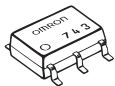

Surface-mounting Terminals

Weight: 0.13 g

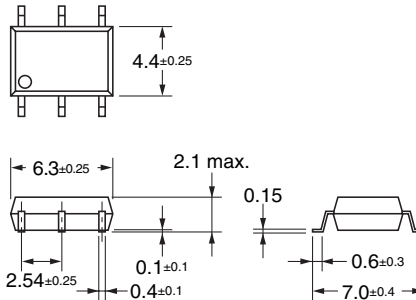

Actual Mounting Pad Dimensions

(Recommended Value, TOP VIEW)

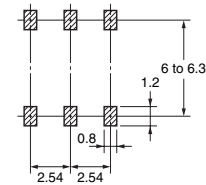

Note: The actual product is marked differently from the image shown here.

- Application examples provided in this document are for reference only. In actual applications, confirm equipment functions and safety before using the product.
- Consult your OMRON representative before using the product under conditions which are not described in the manual or applying the product to nuclear control systems, railroad systems, aviation systems, vehicles, combustion systems, medical equipment, amusement machines, safety equipment, and other systems or equipment that may have a serious influence on lives and property if used improperly. Make sure that the ratings and performance characteristics of the product provide a margin of safety for the system or equipment, and be sure to provide the system or equipment with double safety mechanisms.

Note: Do not use this document to operate the Unit.

OMRON Corporation

ELECTRONIC AND MECHANICAL COMPONENTS COMPANY

Contact: www.omron.com/ecb

Cat. No. **K156-E1-01**
0412(0412)(O)