

Q12 Series Sensor

Datasheet

Miniature self-contained photoelectric sensors in a universal housing

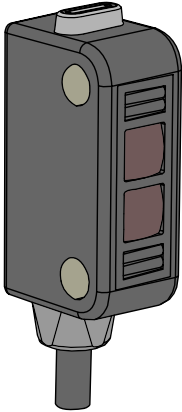

- Bright, visible red (640 nm) light source
- Standard models available with 4-wire 2 m (6.5 ft) or 9 m (30 ft) cable or 3 or 4-wire 150 mm (6 in) pigtail with Pico-style M8 threaded connector
- Solid-state, bipolar outputs: one current sourcing (PNP) and one current sinking (NPN) standard on 4-wire models
- Single output solid-state PNP or NPN standard on Q3 models
- Light Operate (LO) or Dark Operate (DO), depending on model
- Compact 8 mm (0.31 in) housing mounts almost anywhere
- Crosstalk avoidance circuitry for applications with multiple sensors
- LED status indicators for Power ON, Output Overload, Signal Received, and Marginal Signal
- Advanced ASIC technology makes the sensor resistant to optical and electrical noise sources



WARNING

DO NOT USE THIS DEVICE FOR PERSONNEL PROTECTION

Using this device for personnel protection could result in serious injury or death.

- This device does not include the self-checking redundant circuitry necessary to allow its use in personnel safety applications. A device failure or malfunction can cause either an energized (on) or de-energized (off) output condition.

Q12 Models

Table 1: Opposed mode emitter (640 nm visible red) and receiver (effective beam 5.7 mm) models (2 m range)

Model	Connection	Output
Q126E (emitter)	2 m (6.5 ft) cable	N/A
Q126EQ3 (emitter)	150 mm (6 in) cable with a 3-pin M8 QD	N/A
Q12AB6R	2 m (6.5 ft) cable	Bipolar LO
Q12RB6R	2 m (6.5 ft) cable	Bipolar DO
Q12AP6RQ3	150 mm (6 in) cable with a 3-pin M8 QD	1 PNP LO
Q12RP6RQ3	150 mm (6 in) cable with a 3-pin M8 QD	1 PNP DO
Q12AN6RQ3	150 mm (6 in) cable with a 3-pin M8 QD	1 NPN LO
Q12RN6RQ3	150 mm (6 in) cable with a 3-pin M8 QD	1 NPN DO

Retroreflective range is specified using one model **BRT-60X40C** retroreflector. The actual sensing range may be more or less than specified, depending upon the efficiency and reflective area of the retroreflector(s) used.

Table 2: Polarized retroreflective models (640 nm visible red) (1 m range) (Sheet 1 of 2)

Models	Connection	Output
Q12AB6LP	2 m (6.5 ft) cable	Bipolar LO
Q12RB6LP	2 m (6.5 ft) cable	Bipolar DO
Q12AP6LPQ3	150 mm (6 in) cable with a 3-pin M8 QD	1 PNP LO
Q12RP6LPQ3	150 mm (6 in) cable with a 3-pin M8 QD	1 PNP DO
Q12AN6LPQ3	150 mm (6 in) cable with a 3-pin M8 QD	1 NPN LO

Table 2: Polarized retroreflective models (640 nm visible red) (1 m range) (Continued) (Sheet 2 of 2)

Models	Connection	Output
Q12RN6LPQ3	150 mm (6 in) cable with a 3-pin M8 QD	1 NPN DO

Table 3: Retroreflective models (640 nm visible red) (1.5 m range)

Models	Connection	Output
Q12AB6LV	2 m (6.5 ft) cable	Bipolar LO
Q12RB6LV	2 m (6.5 ft) cable	Bipolar DO
Q12AP6LVQ3	150 mm (6 in) cable with a 3-pin M8 QD	1 PNP LO
Q12RP6LVQ3	150 mm (6 in) cable with a 3-pin M8 QD	1 PNP DO
Q12AN6LVQ3	150 mm (6 in) cable with a 3-pin M8 QD	1 NPN LO
Q12RN6LVQ3	150 mm (6 in) cable with a 3-pin M8 QD	1 NPN DO

Table 4: Fixed-field visible red models (640 nm)

Models	Range	Connection	Output
Q12AB6FF15	15 mm (0.6 in) cutoff, 10 mm (0.4 in) focus	2 m (6.5 ft) cable	Bipolar LO
Q12RB6FF15	15 mm (0.6 in) cutoff, 10 mm (0.4 in) focus	2 m (6.5 ft) cable	Bipolar DO
Q12AP6FF15Q3	15 mm (0.6 in) cutoff, 10 mm (0.4 in) focus	150 mm (6 in) cable with a 3-pin M8 QD	1 PNP LO
Q12RP6FF15Q3	15 mm (0.6 in) cutoff, 10 mm (0.4 in) focus	150 mm (6 in) cable with a 3-pin M8 QD	1 PNP DO
Q12AN6FF15Q3	15 mm (0.6 in) cutoff, 10 mm (0.4 in) focus	150 mm (6 in) cable with a 3-pin M8 QD	1 NPN LO
Q12RN6FF15Q3	15 mm (0.6 in) cutoff, 10 mm (0.4 in) focus	150 mm (6 in) cable with a 3-pin M8 QD	1 NPN DO
Q12AB6FF30	30 mm (1.2 in) cutoff, 16 mm (0.63 in) focus	2 m (6.5 ft) cable	Bipolar LO
Q12RB6FF30	30 mm (1.2 in) cutoff, 16 mm (0.63 in) focus	2 m (6.5 ft) cable	Bipolar DO
Q12AP6FF30Q3	30 mm (1.2 in) cutoff, 16 mm (0.63 in) focus	150 mm (6 in) cable with a 3-pin M8 QD	1 PNP LO
Q12RP6FF30Q3	30 mm (1.2 in) cutoff, 16 mm (0.63 in) focus	150 mm (6 in) cable with a 3-pin M8 QD	1 PNP DO
Q12AN6FF30Q3	30 mm (1.2 in) cutoff, 16 mm (0.63 in) focus	150 mm (6 in) cable with a 3-pin M8 QD	1 NPN LO
Q12RN6FF30Q3	30 mm (1.2 in) cutoff, 16 mm (0.63 in) focus	150 mm (6 in) cable with a 3-pin M8 QD	1 NPN DO
Q12AB6FF50	50 mm (2 in) cutoff, 16 mm (0.63 in) focus	2 m (6.5 ft) cable	Bipolar LO
Q12RB6FF50	50 mm (2 in) cutoff, 16 mm (0.63 in) focus	2 m (6.5 ft) cable	Bipolar DO
Q12AP6FF50Q3	50 mm (2 in) cutoff, 16 mm (0.63 in) focus	150 mm (6 in) cable with a 3-pin M8 QD	1 PNP LO
Q12RP6FF50Q3	50 mm (2 in) cutoff, 16 mm (0.63 in) focus	150 mm (6 in) cable with a 3-pin M8 QD	1 PNP DO
Q12AN6FF50Q3	50 mm (2 in) cutoff, 16 mm (0.63 in) focus	150 mm (6 in) cable with a 3-pin M8 QD	1 NPN LO
Q12RN6FF50Q3	50 mm (2 in) cutoff, 16 mm (0.63 in) focus	150 mm (6 in) cable with a 3-pin M8 QD	1 NPN DO

Performance based on use of 90% reflectance white test card.

- To order the 150 mm (6 in) cable with a 4-pin M8 (M8 threaded) QD model, add the suffix **Q** to the model number. For example, **Q126EQ**.
- To order the 150 mm (6 in) cable with a 4-pin M12 QD model, add the suffix **Q5** to the model number. For example **Q126EQ5**.

Indicator Features



- 1 - Amber and green LEDs
- Green on: the power to the sensor is on
 - Amber on: received signal
 - Amber flashing: marginal signal

Wiring

Emitters have no connection to black and white.

CAUTION: Observe proper ESD precautions (grounding) when connecting QD models.

Emitters

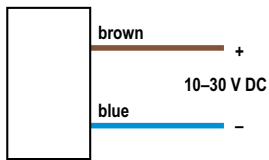

Bipolar Models, Light Operate

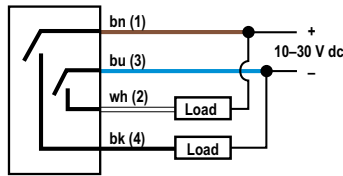

PNP Models, Light Operate

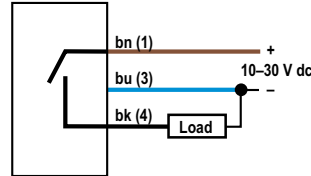

NPN Models, Light Operate

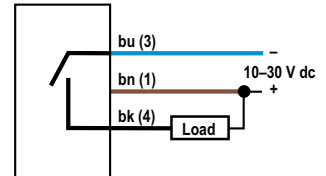

Bipolar Models, Dark Operate

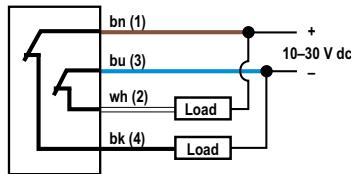

PNP Models, Dark Operate

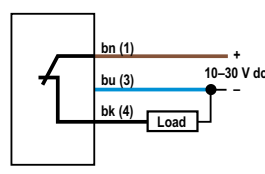

NPN Models, Dark Operate

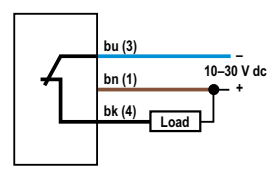

3-pin M8 Male QD

4-pin M8 Male QD

4-pin M12 Male QD

Key

- 1 = Brown
- 2 = White
- 3 = Blue
- 4 = Black

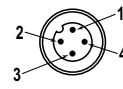
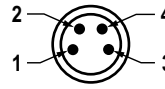

Specifications

Supply Voltage and Current

10 to 30 V DC(10% maximum ripple) at 20 mA maximum current

Sensing Beam

640 nm visible red

Supply Protection Circuitry

Protected against reverse polarity and transient voltages

Sensing Range

Opposed Mode Models: 2 m (6.5 ft)
 Polarized Retroreflective Mode Models: 1 m (40 in)
 Retroreflective Mode Models: 1.5 m (59 in)
 Fixed Field FF15 Models: 15 mm (0.6 in) cutoff, 10 mm (0.4 in) focus
 Fixed Field FF30 Models: 30 mm (1.2 in) cutoff, 16 mm (0.63 in) focus
 Fixed Field FF50 Models: 50 mm (2 in) cutoff; 16 mm (0.63 in) focus

Output Response Time

Opposed Mode: 1.3 ms ON; 900 µs OFF
 LP/LV Mode: 700 µs ON/OFF
 FF Mode: 850 µs ON/OFF
 NOTE: 120 ms delay on power-up; outputs do not conduct during this time.

Construction

Polarized Retro Models: Thermoplastic elastomer housing with glass lens
 All Other Standard Models: Thermoplastic elastomer housing with polycarbonate lens

Connections

Standard Models: 2 m (6.5 ft) attached PVC cable, or 150 mm (6 in) pigtail with M8 or M12 threaded connection, depending on the model ordered

Environmental Rating

Standard Models: IEC IP67

Certifications



Banner Engineering Europe
 Park Lane, Culliganlaan 2F bus 3,
 1831 Diegem, BELGIUM



Turck Banner LTD Blenheim
 House, Blenheim Court, Wickford,
 Essex SS11 8YT, Great Britain



Required Overcurrent Protection

WARNING: Electrical connections must be made by qualified personnel in accordance with local and national electrical codes and regulations.

Overcurrent protection is required to be provided by end product application per the supplied table.
 Overcurrent protection may be provided with external fusing or via Current Limiting, Class 2 Power Supply.
 Supply wiring leads < 24 AWG shall not be spliced.
 For additional product support, go to www.bannerengineering.com.

Supply Wiring (AWG)	Required Overcurrent Protection (Amps)
20	5.0
22	3.0
24	2.0
26	1.0
28	0.8
30	0.5

Dimensions

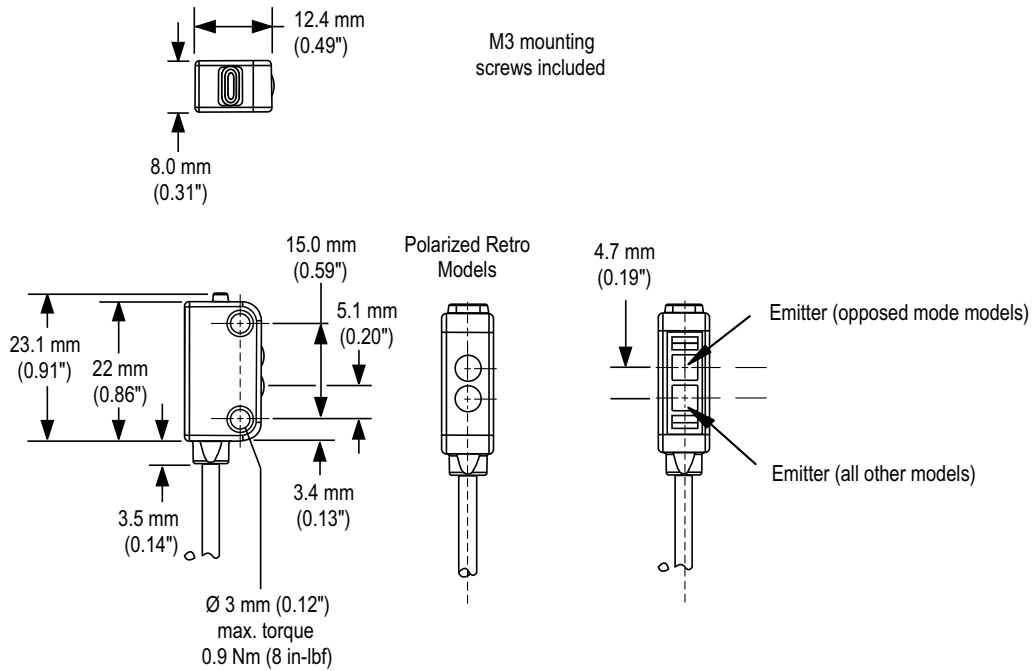
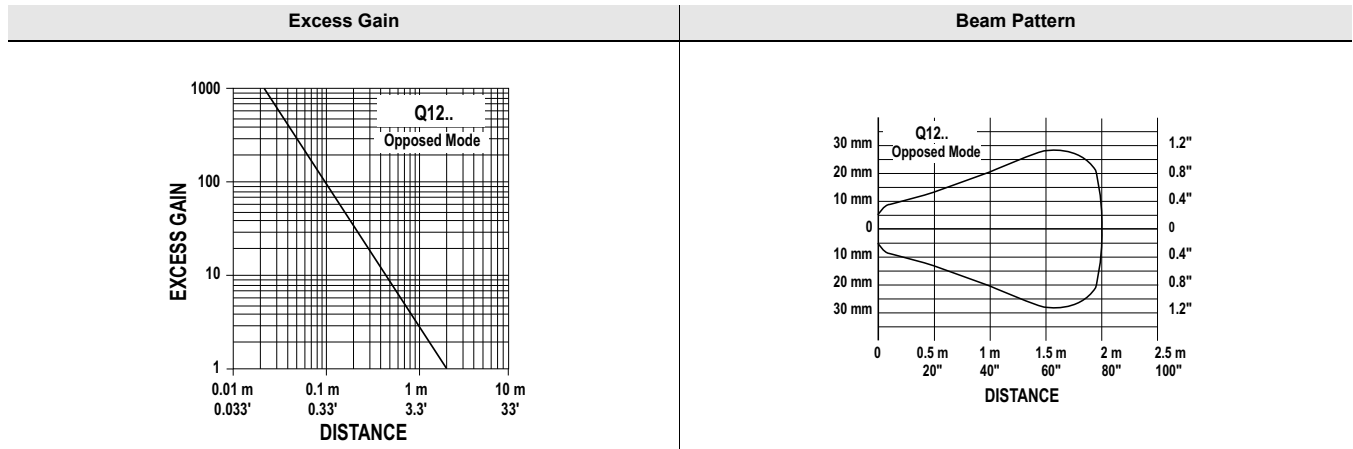

Figure 1: Standard Models

Performance Curves - Opposed Mode



Performance Curves - Retroreflective Mode

Performance is based on the use of a model **BRT-60X40C** retroreflector.

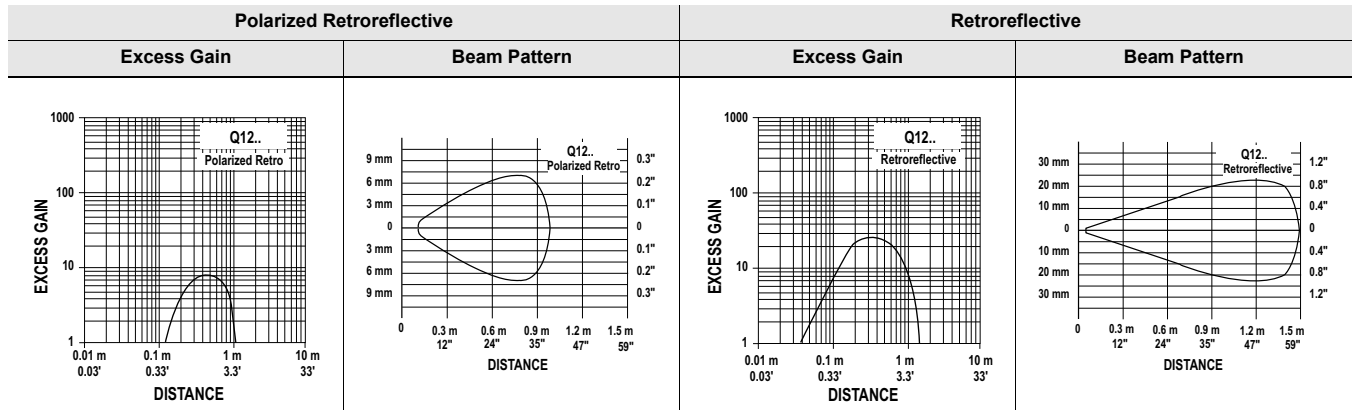

Performance Curves - Q12 Fixed-Field

Focus and spot sizes are typical. Performance based on use of 90% reflectance white test card.*

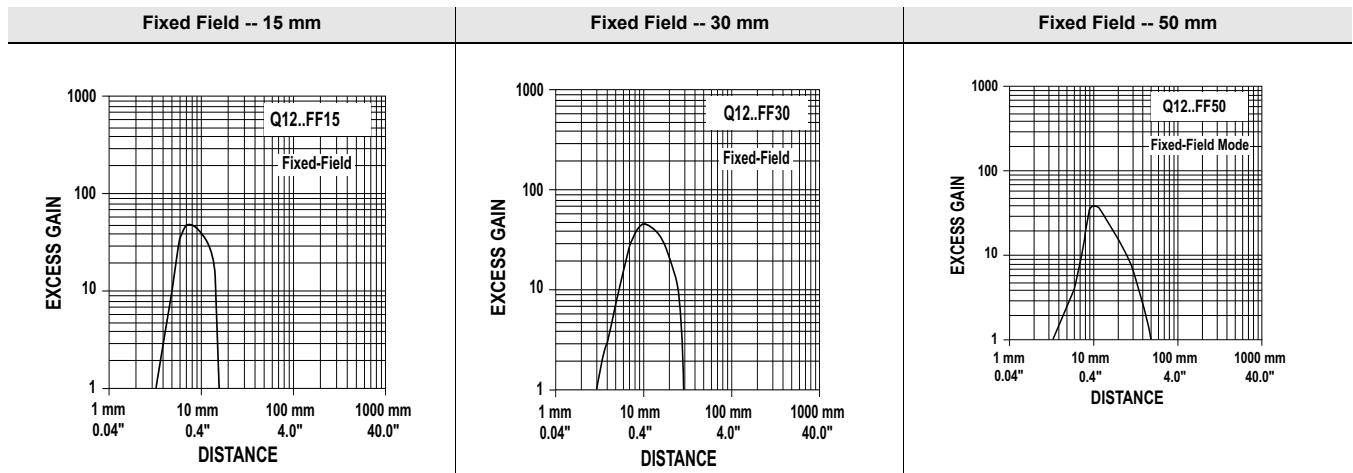

Ø 0.4 mm spot size at 10 mm focus
 Ø 1.5 mm spot size at 15 mm cutoff

* Using the 18% gray test card the cutoff distance will be 95% of the value shown. Using the 6% black test card the cutoff distance will be 90% of the value shown.

Ø 0.5 mm spot size at 16 mm focus
 Ø 3.0 mm spot size at 30 mm cutoff

* Using the 18% gray test card the cutoff distance will be 90% of the value shown. Using the 6% black test card the cutoff distance will be 80% of the value shown.

Ø 0.5 mm spot size at 16 mm focus
 Ø 6.5 mm spot size at 50 mm cutoff

* Using the 18% gray test card the cutoff distance will be 80% of the value shown. Using the 6% black test card the cutoff distance will be 60% of the value shown.

Accessories

Cordsets

3-pin Threaded M8 Cordsets—Single Ended				
Model	Length	Style	Dimensions	Pinout (Female)
PKG3M-2	2.035 m (6.68 ft)	Straight		<ul style="list-style-type: none"> • 1 = Brown • 3 = Blue • 4 = Black
PKG3M-5	5.035 m (16.51 ft)			
PKG3M-7	7.035 m (23.08 ft)			
PKG3M-9	9.035 m (29.64 ft)			
PKG3M-10	10.035 m (32.92 ft)			
PKW3M-2	2 m (6.56 ft)	Right-Angle		<ul style="list-style-type: none"> • 1 = Brown • 3 = Blue • 4 = Black
PKW3M-5	5 m (16.40 ft)			
PKW3M-9	9 m (29.53 ft)			

4-Pin Threaded M8 Cordsets—Single Ended				
Model	Length	Style	Dimensions	Pinout (Female)
PKG4M-2	2.04 m (6.68 ft)	Straight		<ul style="list-style-type: none"> • 1 = Brown • 2 = White • 3 = Blue • 4 = Black
PKG4M-5	5 m (16.4 ft)			
PKG4M-9	9.04 m (29.6 ft)			
PKW4M-2	2 m (6.56 ft)	Right Angle		<ul style="list-style-type: none"> • 1 = Brown • 2 = White • 3 = Blue • 4 = Black
PKW4M-5	5 m (16.4 ft)			
PKW4M-9	9 m (29.5 ft)			

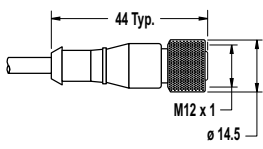
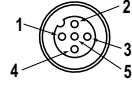
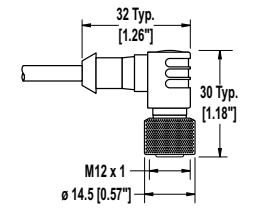
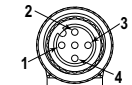
4-Pin Threaded M12 Cordsets—Single Ended				
Model	Length	Style	Dimensions	Pinout (Female)
MQDC-406	2 m (6.56 ft)	Straight		 <ul style="list-style-type: none"> • 1 = Brown • 2 = White • 3 = Blue • 4 = Black • 5 = Unused
MQDC-415	5 m (16.4 ft)			
MQDC-430	9 m (29.5 ft)			
MQDC-450	15 m (49.2 ft)			
MQDC-406RA	2 m (6.56 ft)	Right-Angle		
MQDC-415RA	5 m (16.4 ft)			
MQDC-430RA	9 m (29.5 ft)			
MQDC-450RA	15 m (49.2 ft)			

Brackets

SMBQ12T

- Right-angle bracket
- 20-ga. 300 series stainless steel

Hole center spacing: A to B = 7.6

Hole size: A = 3.5 x 8.1, B = ø 3.2

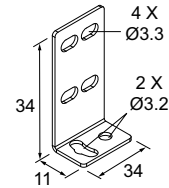

SMBQ12A



- Adjustable right-angle bracket
- 20-ga. 300 series stainless steel

Hole center spacing: A to B = 7.6

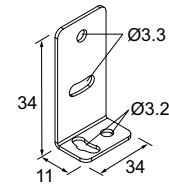
Hole size: A = 3.5 x 8.1, B = ø 3.2

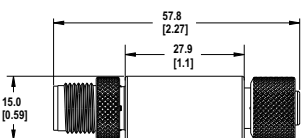
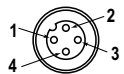

Sensor Status Indicators

S15L Series In-Line Sensor Status Indicator						
Model	Input Type	LED Color	Dimensions	Female	Male	Wiring
S15LGYPQ	PNP	Power ON = Green Input Active = Yellow				1 = Brown, 10 to 30 V DC 2 = White 3 = Blue, DC common 4 = Black, Sensor Input
S15LGYNQ	NPN					

Apertures

Opposed-mode sensors (standard models only) may be fitted with apertures to narrow or shape the sensor's effective beam to more closely match the size or profile of the objects being sensed. A common example is using "line" (or "slot") type apertures to sense thread.

NOTE: The use of apertures will reduce the sensing range (see table below).

Model	Description	Pieces	Reduced Sensor Range?(Two Apertures Used)	
Circular				
APQ12-.5	0.5 mm (0.02 in) diameter	10	60 mm (2.4 in)	
APQ12-1	1 mm (0.04 in) diameter	10	190 mm (7.5 in)	
APQ12-1.5	1.5 mm (0.06 in) diameter	10	400 mm (15.7 in)	
APQ12-2	2 mm (0.08 in) diameter	10	725 mm (28.5 in)	
Horizontal Slot				
APQ12-.5H	0.5 mm (0.02 in)	10	350 mm (13.8 in)	
APQ12-1H	1 mm (0.04 in)	10	725 mm (28.5 in)	
Vertical Slot				
APQ12-.5V	0.5 mm (0.02 in)	10	450 mm (17.7 in)	
APQ12-1V	1 mm (0.04 in)	10	900 mm (35.4 in)	
Protective Jacket				
APQ12-4S	4 mm (0.16 in) square	10	2000 mm (78.7 in)	
APKQ12	Kit containing two of each aperture above	18	—	

Banner Engineering Corp Limited Warranty

Banner Engineering Corp. warrants its products to be free from defects in material and workmanship for one year following the date of shipment. Banner Engineering Corp. will repair or replace, free of charge, any product of its manufacture which, at the time it is returned to the factory, is found to have been defective during the warranty period. This warranty does not cover damage or liability for misuse, abuse, or the improper application or installation of the Banner product.

THIS LIMITED WARRANTY IS EXCLUSIVE AND IN LIEU OF ALL OTHER WARRANTIES WHETHER EXPRESS OR IMPLIED (INCLUDING, WITHOUT LIMITATION, ANY WARRANTY OF MERCHANTABILITY OR FITNESS FOR A PARTICULAR PURPOSE), AND WHETHER ARISING UNDER COURSE OF PERFORMANCE, COURSE OF DEALING OR TRADE USAGE.

This Warranty is exclusive and limited to repair or, at the discretion of Banner Engineering Corp., replacement. **IN NO EVENT SHALL BANNER ENGINEERING CORP. BE LIABLE TO BUYER OR ANY OTHER PERSON OR ENTITY FOR ANY EXTRA COSTS, EXPENSES, LOSSES, LOSS OF PROFITS, OR ANY INCIDENTAL, CONSEQUENTIAL OR SPECIAL DAMAGES RESULTING FROM ANY PRODUCT DEFECT OR FROM THE USE OR INABILITY TO USE THE PRODUCT, WHETHER ARISING IN CONTRACT OR WARRANTY, STATUTE, TORT, STRICT LIABILITY, NEGLIGENCE, OR OTHERWISE.**

Banner Engineering Corp. reserves the right to change, modify or improve the design of the product without assuming any obligations or liabilities relating to any product previously manufactured by Banner Engineering Corp. Any misuse, abuse, or improper application or installation of this product or use of the product for personal protection applications when the product is identified as not intended for such purposes will void the product warranty. Any modifications to this product without prior express approval by Banner Engineering Corp will void the product warranties. All specifications published in this document are subject to change; Banner reserves the right to modify product specifications or update documentation at any time. Specifications and product information in English supersede that which is provided in any other language. For the most recent version of any documentation, refer to: www.bannerengineering.com.

For patent information, see www.bannerengineering.com/patents.

FCC Part 15 Class A

This equipment has been tested and found to comply with the limits for a Class A digital device, pursuant to part 15 of the FCC Rules. These limits are designed to provide reasonable protection against harmful interference when the equipment is operated in a commercial environment. This equipment generates, uses, and can radiate radio frequency energy and, if not installed and used in accordance with the instruction manual, may cause harmful interference to radio communications. Operation of this equipment in a residential area is likely to cause harmful interference in which case the user will be required to correct the interference at his own expense.

Industry Canada

This device complies with CAN ICES-3 (A)/NMB-3(A). Operation is subject to the following two conditions: 1) This device may not cause harmful interference; and 2) This device must accept any interference received, including interference that may cause undesired operation.

Cet appareil est conforme à la norme NMB-3(A). Le fonctionnement est soumis aux deux conditions suivantes : (1) ce dispositif ne peut pas occasionner d'interférences, et (2) il doit tolérer toute interférence, y compris celles susceptibles de provoquer un fonctionnement non souhaité du dispositif.

Revision: N
Original Instructions
© Banner Engineering Corp. All rights reserved.

