

Comparators

# Input Full Swing, Push-pull Output Low Voltage CMOS Comparators

**BU7231G BU7231SG BU7232xxx BU7232Sxxx**

**General Description**

BU7231G/BU7232xxx are input full swing and push pull output comparators. BU7231SG/BU7232Sxxx have an expanded operating temperature range. These features low operating supply voltage of +1.8V to +5.5V(single supply) with low supply current and extremely low input bias current.

**Features**

- Low Operating Supply Voltage
- Input/Output Full Swing
- Push-pull Output
- Low Supply Current
- Wide Operating Temperature Range

**Key Specifications**

- Operating Supply Voltage (Single Supply): +1.8V to +5.5V
- Supply Current (VDD=3V, T<sub>A</sub>=25°C):
  - BU7231G/BU7231SG 5μA
  - BU7232xxx/BU7232Sxxx 10μA
- Input Bias Current (T<sub>A</sub>=25°C): 1pA
- Operating Temperature Range:
  - BU7231G/BU7232xxx -40°C to 85°C
  - BU7231SG/BU7232Sxxx -40°C to 105°C

**Package**

- SSOP5 W(Typ) xD(Typ) xH(Max)  
2.90mm x 2.80mm x 1.25mm
- SOP8 5.00mm x 6.20mm x 1.71mm
- MSOP8 2.90mm x 4.00mm x 0.90mm

**Applications**

- Battery Monitor
- Mobile Equipments
- Limit Comparator
- Multivibrators
- Consumer Electronics

**Pin Configuration**

BU7231G, BU7231SG: SSOP5

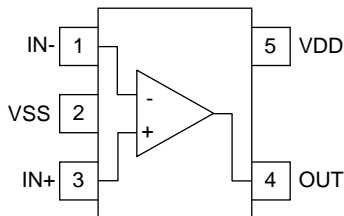

Pin No.	Pin Name
1	IN-
2	VSS
3	IN+
4	OUT
5	VDD

BU7232F, BU7232SF: SOP8

BU7232FVM, BU7232SFVM: MSOP8

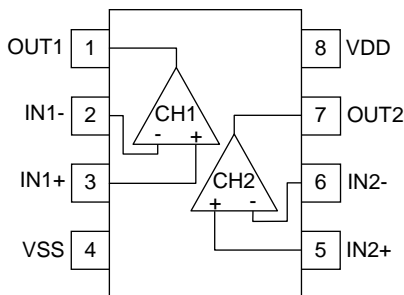

Pin No.	Pin Name
1	OUT1
2	IN1-
3	IN1+
4	VSS
5	IN2+
6	IN2-
7	OUT2
8	VDD

○Product structure : Silicon monolithic integrated circuit ○This product is not designed protection against radioactive rays.

Package		
SSOP5	SOP8	MSOP8
BU7231G BU7231SG	BU7232F BU7232SF	BU7232FVM BU7232SFVM

**Ordering Information**

B	U	7	2	3	x	x	x	x	x	-	x	x
---	---	---	---	---	---	---	---	---	---	---	---	---

Part Number BU7231G BU7231SG BU7232xxx BU7232Sxxx	Package G : SSOP5 F : SOP8 FVM : MSOP8	Packaging and Forming Specification TR: Embossed Tape and Reel (SSOP5/MSOP8) E2: Embossed tape and reel (SOP8)
---	---	--

**Line-up**

T <sub>opr</sub>	Channels	Package		Orderable Part Number
-40°C to +85°C	1ch	SSOP5	Reel of 3000	BU7231G-TR
	2ch	SOP8	Reel of 2500	BU7232F-E2
		MSOP8	Reel of 3000	BU7232FVM-TR
-40°C to +105°C	1ch	SSOP5	Reel of 3000	BU7231SG-TR
	2ch	SOP8	Reel of 2500	BU7232SF-E2
		MSOP8	Reel of 3000	BU7232SFVM-TR

**Absolute Maximum Ratings (T<sub>A</sub>=25°C)**

Parameter	Symbol	Rating				Unit	
		BU7231G	BU7232xxx	BU7231SG	BU7232Sxxx		
Supply Voltage	VDD-VSS	+7				V	
Power Dissipation	P <sub>D</sub>	SSOP5	0.54 <sup>(Note 1,4)</sup>	-	0.54 <sup>(Note 1,4)</sup>	W	
		SOP8	-	0.55 <sup>(Note 2,4)</sup>	-		0.55 <sup>(Note 2,4)</sup>
		MSOP8	-	0.47 <sup>(Note 3,4)</sup>	-		0.47 <sup>(Note 3,4)</sup>
Differential Input Voltage <sup>(Note 5)</sup>	V <sub>ID</sub>	VDD - VSS				V	
Input Common-mode Voltage Range	V <sub>ICM</sub>	(VSS - 0.3) to (VDD + 0.3)				V	
Input Current <sup>(Note 6)</sup>	I <sub>I</sub>	±10				mA	
Operating Supply Voltage	V <sub>opr</sub>	+1.8 to +5.5 ±0.9 to ±2.75				V	
Operating Temperature	T <sub>opr</sub>	-40 to +85		-40 to +105		°C	
Storage Temperature	T <sub>stg</sub>	-55 to +125				°C	
Maximum Junction Temperature	T <sub>Jmax</sub>	+125				°C	

(Note 1) To use at temperature above T<sub>A</sub>=25°C reduce 5.4mW/°C.

(Note 2) To use at temperature above T<sub>A</sub>=25°C reduce 5.5mW/°C.

(Note 3) To use at temperature above T<sub>A</sub>=25°C reduce 4.7mW/°C.

(Note 4) Mounted on a FR4 glass epoxy PCB 70mmx70mmx1.6mm (Copper foil area less than 3%).

(Note 5) The voltage difference between inverting input and non-inverting input is the differential input voltage. Then input pin voltage is set to more than VSS.

(Note 6) An excessive input current will flow when input voltages of more than VDD+0.6V or less than VSS-0.6V are applied. The input current can be set to less than the rated current by adding a limiting resistor.

Caution: Operating the IC over the absolute maximum ratings may damage the IC. The damage can either be a short circuit between pins or an open circuit between pins and the internal circuitry. Therefore, it is important to consider circuit protection measures, such as adding a fuse, in case the IC is operated over the absolute maximum ratings.

## Electrical Characteristics

OBU7231G, BU7231SG (Unless otherwise specified VDD=+3V, VSS=0V, T<sub>A</sub>=25°C)

Parameter	Symbol	Temperature Range	Limit			Unit	Condition
			Min	Typ	Max		
Input Offset Voltage <sup>(Note 7)</sup>	V <sub>IO</sub>	25°C	-	1	11	mV	-
Input Offset Current <sup>(Note 7)</sup>	I <sub>IO</sub>	25°C	-	1	-	pA	-
Input Bias Current <sup>(Note 7)</sup>	I <sub>B</sub>	25°C	-	1	-	pA	-
Supply Current <sup>(Note 8)</sup>	I <sub>DD</sub>	25°C	-	5	15	μA	R <sub>L</sub> =∞
		Full Range	-	-	30		
Maximum Output Voltage (High)	V <sub>OH</sub>	25°C	VDD-0.1	-	-	V	R <sub>L</sub> =10kΩ, V <sub>RL</sub> =VDD/2
Maximum Output Voltage (Low)	V <sub>OL</sub>	25°C	-	-	VSS+0.1	V	R <sub>L</sub> =10kΩ, V <sub>RL</sub> =VDD/2
Large Single Voltage Gain	A <sub>v</sub>	25°C	-	90	-	dB	R <sub>L</sub> =10kΩ, V <sub>RL</sub> =VDD/2
Input Common-mode Voltage Range	V <sub>ICM</sub>	25°C	0	-	3	V	VDD-VSS=3V
Common-mode Rejection Ratio	CMRR	25°C	-	80	-	dB	V <sub>ICM</sub> =VDD/2
Power Supply Rejection Ratio	PSRR	25°C	-	80	-	dB	-
Output Source Current <sup>(Note 9)</sup>	I <sub>SOURCE</sub>	25°C	1	2	-	mA	OUT=VDD-0.4V
Output Sink Current <sup>(Note 9)</sup>	I <sub>SINK</sub>	25°C	3	6	-	mA	OUT=VSS+0.4V
Output Rise Time	t <sub>R</sub>	25°C	-	50	-	ns	C <sub>L</sub> =15pF, IN=-1.5V 100mV Overdrive
Output Fall Time	t <sub>F</sub>	25°C	-	20	-	ns	C <sub>L</sub> =15pF, IN=-1.5V 100mV Overdrive
Propagation Delay Time L to H	t <sub>PLH</sub>	25°C	-	1.7	-	μs	C <sub>L</sub> =15pF, IN=-1.5V 100mV Overdrive
Propagation Delay Time H to L	t <sub>PHL</sub>	25°C	-	0.6	-	μs	C <sub>L</sub> =15pF, IN=-1.5V 100mV Overdrive

(Note 7) Absolute value.

(Note 8) Full range: BU7231G: T<sub>A</sub>=-40°C to +85°C BU7231SG: T<sub>A</sub>=-40°C to +105°C.

(Note 9) Under the high temperature environment, consider the power dissipation of IC when selecting the output current.

When the terminal short circuits are continuously output, the output current is reduced to climb to the temperature inside IC.

## Electrical Characteristics - continued

OBU7232xxx, BU7232Sxxx (Unless otherwise specified VDD=+3V, VSS=0V, T<sub>A</sub>=25°C)

Parameter	Symbol	Temperature Range	Limit			Unit	Condition
			Min	Typ	Max		
Input Offset Voltage <sup>(Note 10)</sup>	V <sub>IO</sub>	25°C	-	1	11	mV	-
Input Offset Current <sup>(Note 10)</sup>	I <sub>IO</sub>	25°C	-	1	-	pA	-
Input Bias Current <sup>(Note 10)</sup>	I <sub>B</sub>	25°C	-	1	-	pA	-
Supply Current <sup>(Note 11)</sup>	I <sub>DD</sub>	25°C	-	10	25	μA	R <sub>L</sub> =∞, All Comparators
		Full Range	-	-	50		
Maximum Output Voltage (High)	V <sub>OH</sub>	25°C	VDD-0.1	-	-	V	R <sub>L</sub> =10kΩ, V <sub>RL</sub> =VDD/2
Maximum Output Voltage (Low)	V <sub>OL</sub>	25°C	-	-	VSS+0.1	V	R <sub>L</sub> =10kΩ, V <sub>RL</sub> =VDD/2
Large Single Voltage Gain	A <sub>v</sub>	25°C	-	90	-	dB	R <sub>L</sub> =10kΩ, V <sub>RL</sub> =VDD/2
Input Common-mode Voltage Range	V <sub>ICM</sub>	25°C	0	-	3	V	VDD-VSS=3V
Common-mode Rejection Ratio	CMRR	25°C	-	80	-	dB	V <sub>ICM</sub> =VDD/2
Power Supply Rejection Ratio	PSRR	25°C	-	80	-	dB	-
Output Source Current <sup>(Note 12)</sup>	I <sub>SOURCE</sub>	25°C	1	2	-	mA	OUT=VDD-0.4V
Output Sink Current <sup>(Note 12)</sup>	I <sub>SINK</sub>	25°C	3	6	-	mA	OUT=VSS+0.4V
Output Rise Time	t <sub>R</sub>	25°C	-	50	-	ns	C <sub>L</sub> =15pF, IN=-1.5V 100mV Overdrive
Output Fall Time	t <sub>F</sub>	25°C	-	20	-	ns	C <sub>L</sub> =15pF, IN=-1.5V 100mV Overdrive
Propagation Delay Time L to H	t <sub>PLH</sub>	25°C	-	1.7	-	μs	C <sub>L</sub> =15pF, IN=-1.5V 100mV Overdrive
Propagation Delay Time H to L	t <sub>PHL</sub>	25°C	-	0.6	-	μs	C <sub>L</sub> =15pF, IN=-1.5V 100mV Overdrive

(Note 10) Absolute value.

(Note 11) Full range: BU7232xxx: T<sub>A</sub>=-40°C to +85°C BU7232Sxxx: T<sub>A</sub>=-40°C to +105°C.

(Note 12) Under the high temperature environment, consider the power dissipation of IC when selecting the output current.

When the terminal short circuits are continuously output, the output current is reduced to climb to the temperature inside IC.

## Description of Electrical Characteristics

Described below are descriptions of the relevant electrical terms used in this datasheet. Items and symbols used are also shown. Note that item name and symbol and their meaning may differ from those on another manufacturer's document or general document.

### 1. Absolute Maximum Ratings

Absolute maximum rating items indicate the condition which must not be exceeded. Application of voltage in excess of absolute maximum rating or use out of absolute maximum rated temperature environment may cause deterioration of characteristics.

- (1) Supply Voltage (VDD/VSS)  
Indicates the maximum voltage that can be applied between the VDD terminal and VSS terminal without deterioration or destruction of characteristics of internal circuit.
- (2) Differential Input Voltage ( $V_{ID}$ )  
Indicates the maximum voltage that can be applied between non-inverting and inverting terminals without damaging the IC.
- (3) Input Common-mode Voltage Range ( $V_{ICM}$ )  
Indicates the maximum voltage that can be applied to the non-inverting and inverting terminals without deterioration or destruction of electrical characteristics. Input common-mode voltage range of the maximum ratings does not assure normal operation of IC. For normal operation, use the IC within the input common-mode voltage range characteristics.
- (4) Power Dissipation ( $P_D$ )  
Indicates the power that can be consumed by the IC when mounted on a specific board at the ambient temperature 25°C (normal temperature). As for package product,  $P_D$  is determined by the temperature that can be permitted by the IC in the package (maximum junction temperature) and the thermal resistance of the package.

### 2. Electrical Characteristics

- (1) Input Offset Voltage ( $V_{IO}$ )  
Indicates the voltage difference between non-inverting terminal and inverting terminals. It can be translated into the input voltage difference required for setting the output voltage at 0 V.
- (2) Input Offset Current ( $I_{IO}$ )  
Indicates the difference of input bias current between the non-inverting and inverting terminals.
- (3) Input Bias Current ( $I_B$ )  
Indicates the current that flows into or out of the input terminal. It is defined by the average of input bias currents at the non-inverting and inverting terminals.
- (4) Supply Current ( $I_{DD}$ )  
Indicates the current that flows within the IC under specified no-load conditions.
- (5) Maximum Output Voltage(High) / Maximum Output Voltage(Low) ( $V_{OH}/V_{OL}$ )  
Indicates the voltage range of the output under specified load condition. It is typically divided into maximum output voltage high and low. Maximum output voltage high indicates the upper limit of output voltage. Maximum output voltage low indicates the lower limit.
- (6) Large Signal Voltage Gain ( $A_V$ )  
Indicates the amplifying rate (gain) of output voltage against the voltage difference between non-inverting terminal and inverting terminal. It is normally the amplifying rate (gain) with reference to DC voltage.  
 $A_V = (\text{Output voltage}) / (\text{Differential Input voltage})$
- (7) Input Common-mode Voltage Range ( $V_{ICM}$ )  
Indicates the input voltage range where IC normally operates.
- (8) Common-mode Rejection Ratio (CMRR)  
Indicates the ratio of fluctuation of input offset voltage when the input common mode voltage is changed. It is normally the fluctuation of DC.  
 $CMRR = (\text{Change of Input common-mode voltage}) / (\text{Input offset fluctuation})$
- (9) Power Supply Rejection Ratio (PSRR)  
Indicates the ratio of fluctuation of input offset voltage when supply voltage is changed.  
It is normally the fluctuation of DC.  
 $PSRR = (\text{Change of power supply voltage}) / (\text{Input offset fluctuation})$
- (10) Output Source Current/ Output Sink Current ( $I_{SOURCE} / I_{SINK}$ )  
The maximum current that can be output from the IC under specific output conditions. The output source current indicates the current flowing out from the IC, and the output sink current indicates the current flowing into the IC.
- (11) Output Rise Time/Output Fall Time ( $t_R / t_F$ )  
Indicates the time required for an output voltage step to change from 10% to 90% of its final value.
- (12) Propagation Delay Time L to H/Propagation Delay Time H to L ( $t_{PLH} / t_{PHL}$ )  
Indicates the time to reach 50% of the output voltage after the step voltage is applied at the input pin.

Typical Performance Curves

OBU7231G, BU7231SG

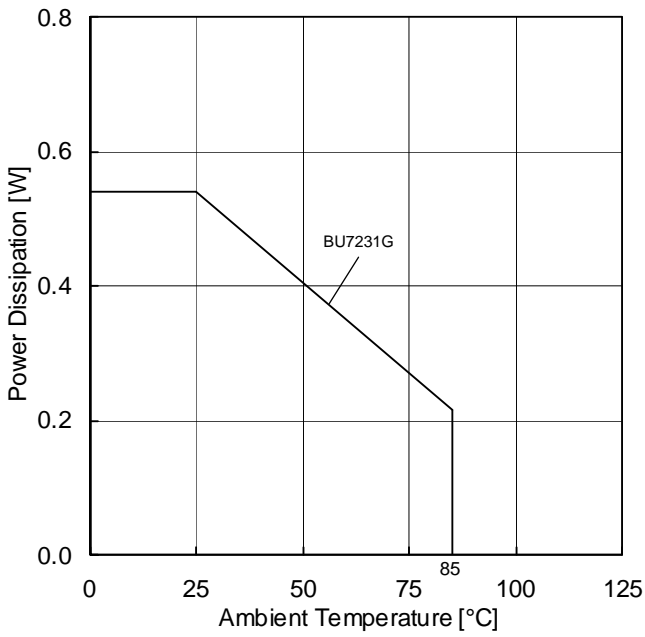

Figure 1.  
Power Dissipation vs Ambient Temperature  
(Derating Curve)

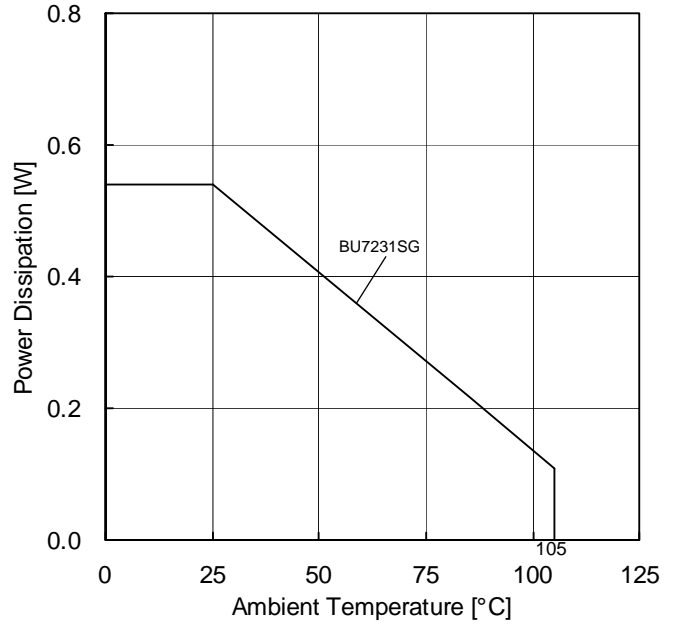

Figure 2.  
Power Dissipation vs Ambient Temperature  
(Derating Curve)

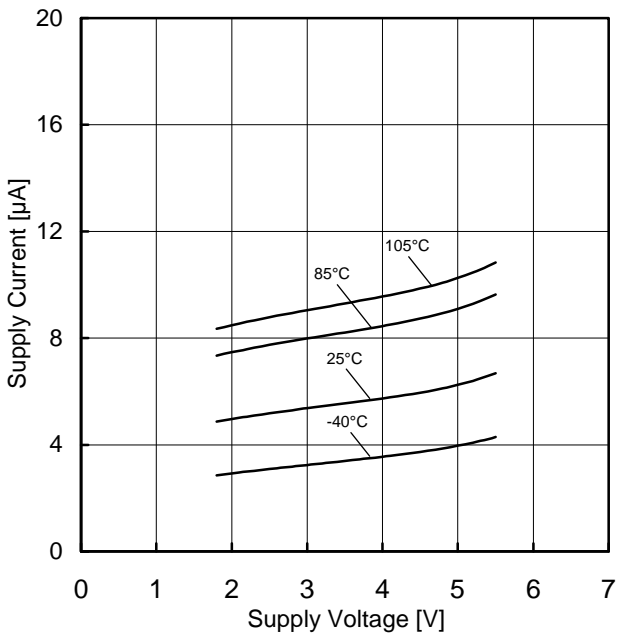

Figure 3.  
Supply Current vs Supply Voltage

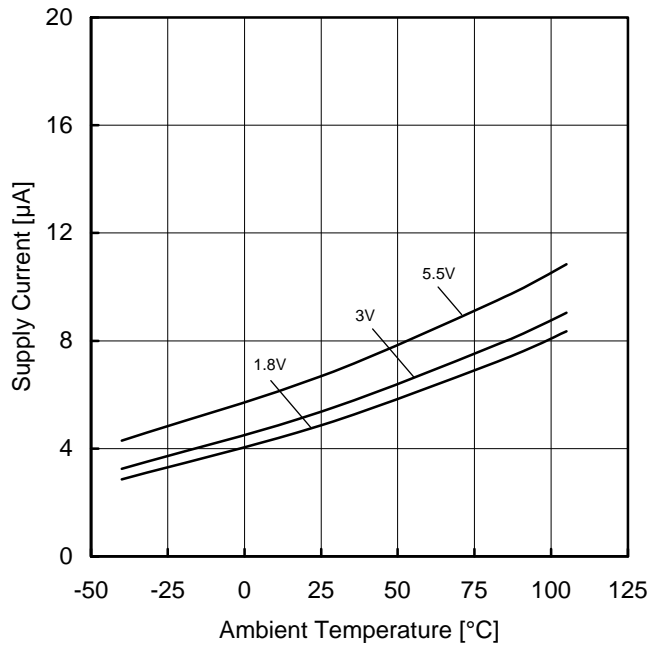

Figure 4.  
Supply Current vs Ambient Temperature

(\*) The above characteristics are measurements of typical sample, they are not guaranteed.  
BU7231G: -40°C to +85°C BU7231SG: -40°C to +105°C

Typical Performance Curves - continued

OBU7231G, BU7231SG

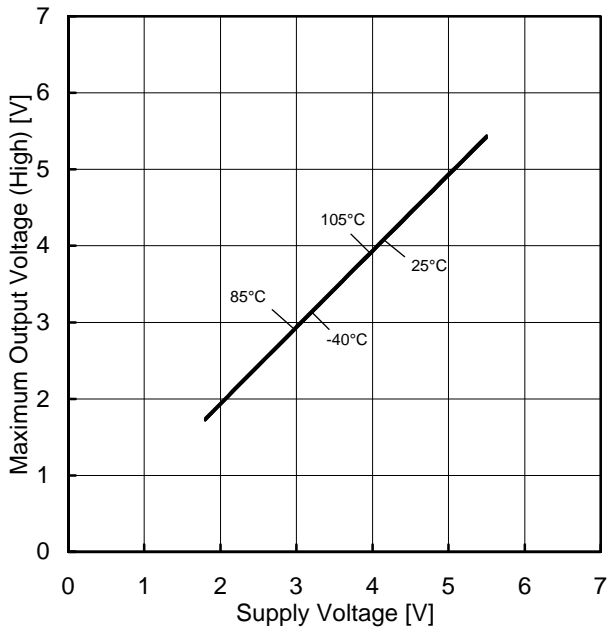

Figure 5.  
Maximum Output Voltage (High) vs Supply Voltage  
( $R_L=10k\Omega$ )

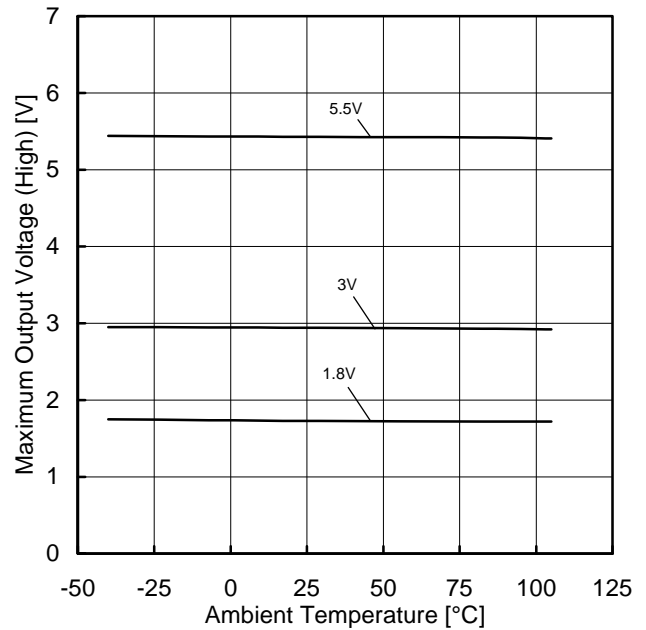

Figure 6.  
Maximum Output Voltage (High) vs Ambient Temperature  
( $R_L=10k\Omega$ )

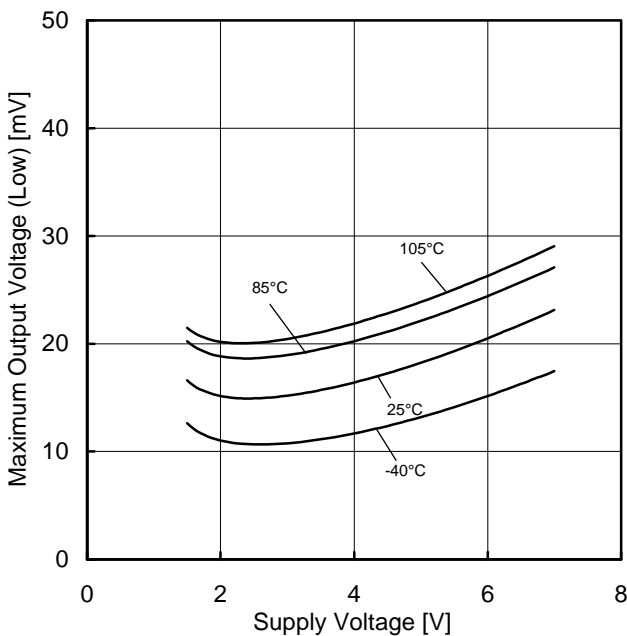

Figure 7.  
Maximum Output Voltage (Low) vs Supply Voltage  
( $R_L=10k\Omega$ )

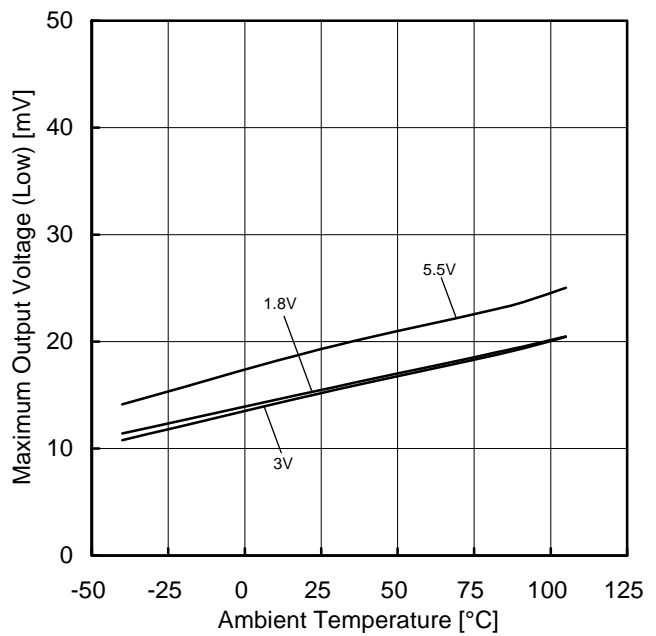

Figure 8.  
Maximum Output Voltage (Low) vs Ambient Temperature  
( $R_L=10k\Omega$ )

(\*) The above characteristics are measurements of typical sample, they are not guaranteed.  
BU7231G: -40°C to +85°C BU7231SG: -40°C to +105°C

Typical Performance Curves - continued

OBU7231G, BU7231SG

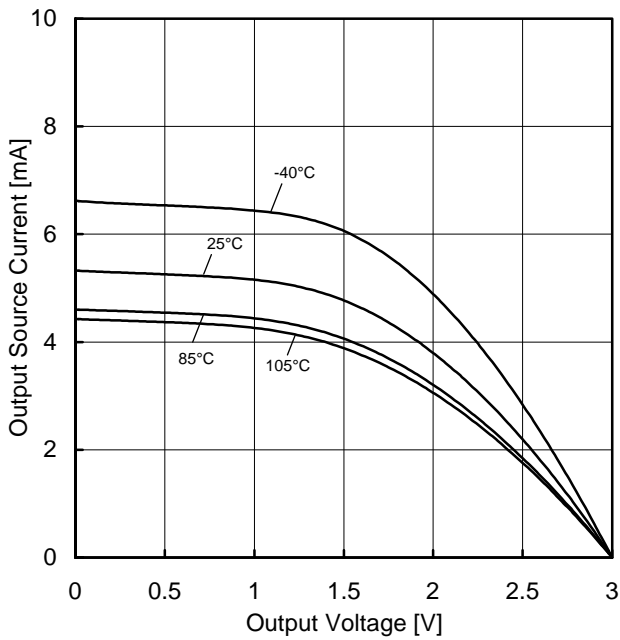

Figure 9.  
Output Source Current vs Output Voltage  
(VDD=3V)

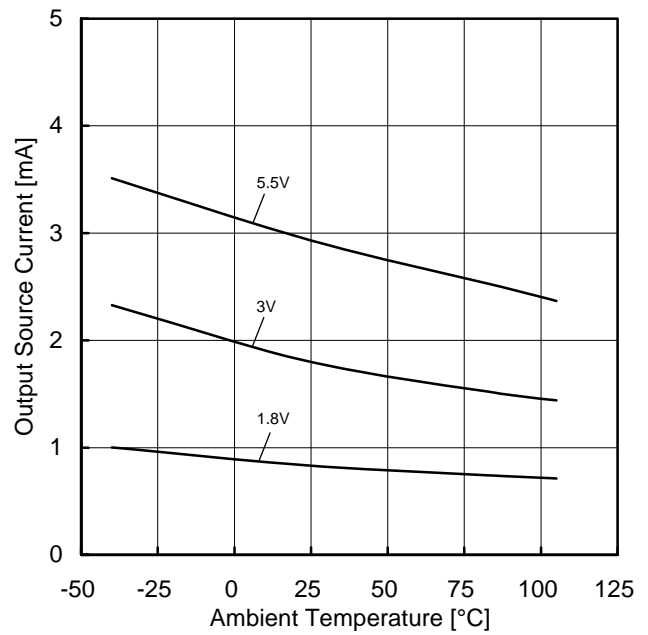

Figure 10.  
Output Source Current vs Ambient Temperature  
(OUT=VDD-0.4V)

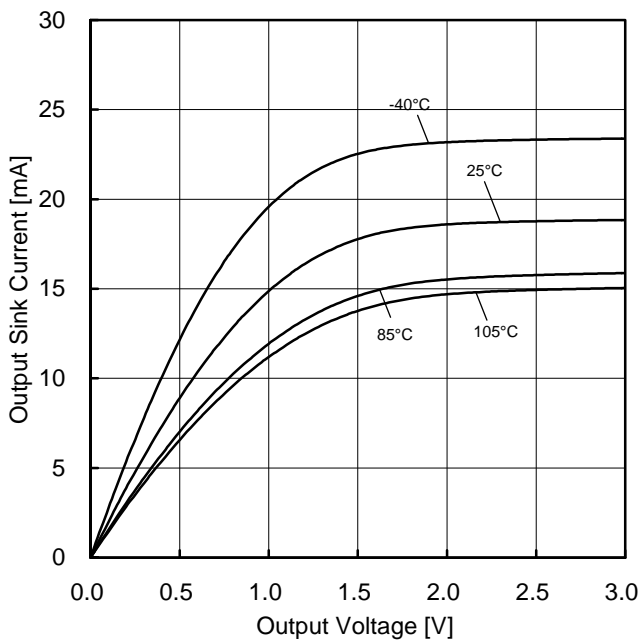

Figure 11.  
Output Sink Current vs Output Voltage  
(VDD=3V)

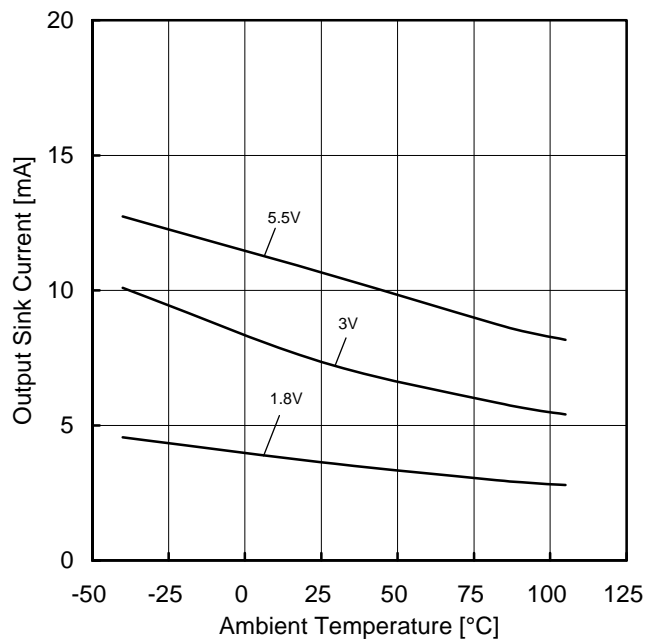

Figure 12.  
Output Sink Current vs Ambient Temperature  
(OUT=VSS+0.4V)

(\*) The above characteristics are measurements of typical sample, they are not guaranteed.  
BU7231G: -40°C to +85°C BU7231SG: -40°C to +105°C



Typical Performance Curves - continued

OBU7231G, BU7231SG

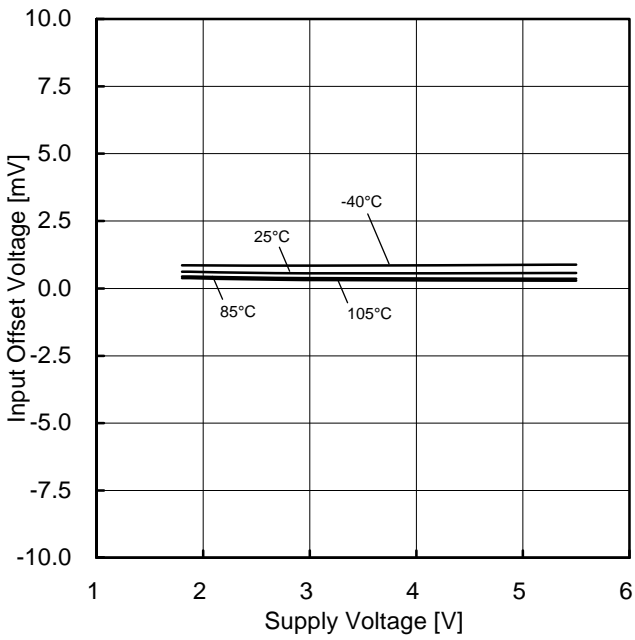

Figure 13.  
Input Offset Voltage vs Supply Voltage  
( $V_{ICM}=V_{DD}$ ,  $E_K=-V_{DD}/2$ )

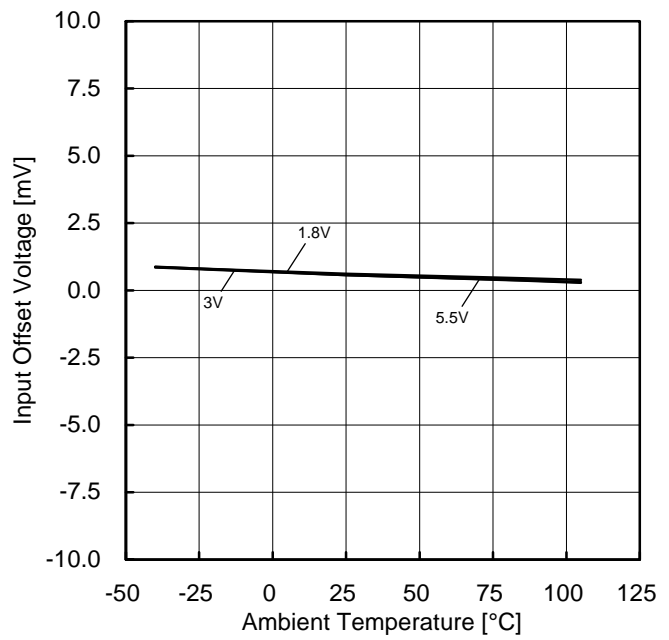

Figure 14.  
Input Offset Voltage vs Ambient Temperature  
( $V_{ICM}=V_{DD}$ ,  $E_K=-V_{DD}/2$ )

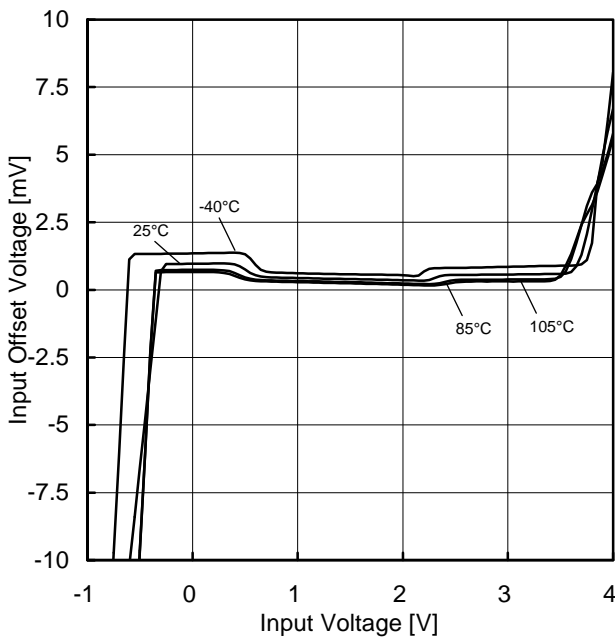

Figure 15.  
Input Offset Voltage vs Input Voltage  
( $V_{DD}=3V$ )

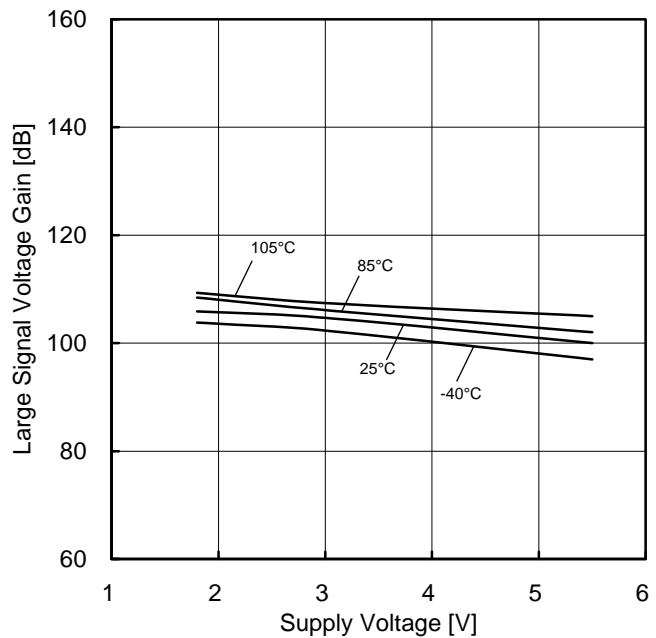

Figure 16.  
Large Signal Voltage Gain vs Supply Voltage

(\*) The above characteristics are measurements of typical sample, they are not guaranteed.  
BU7231G: -40°C to +85°C BU7231SG: -40°C to +105°C

Typical Performance Curves - continued

OBU7231G, BU7231SG

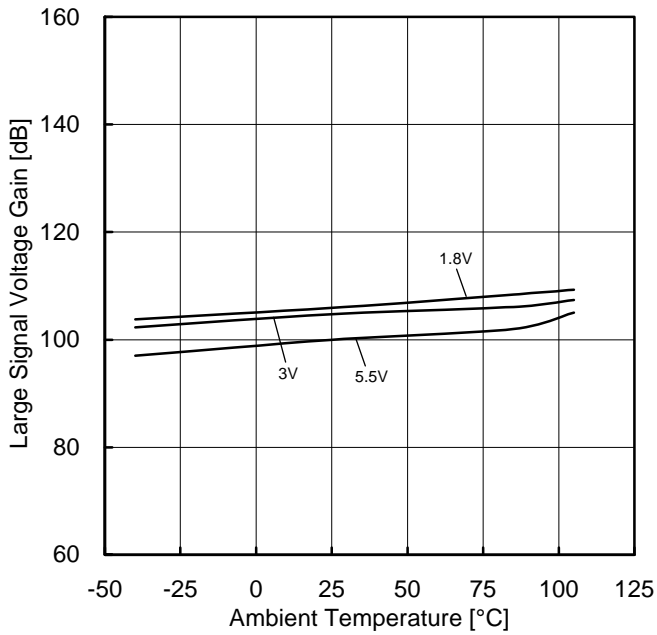

Figure 17.  
Large Signal Voltage Gain vs Ambient Temperature

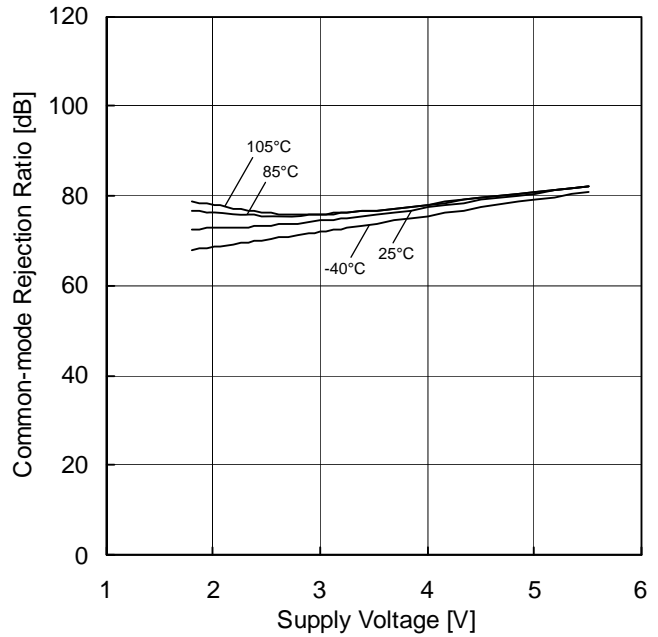

Figure 18.  
Common-mode Rejection Ratio vs Supply Voltage (VDD=3V)

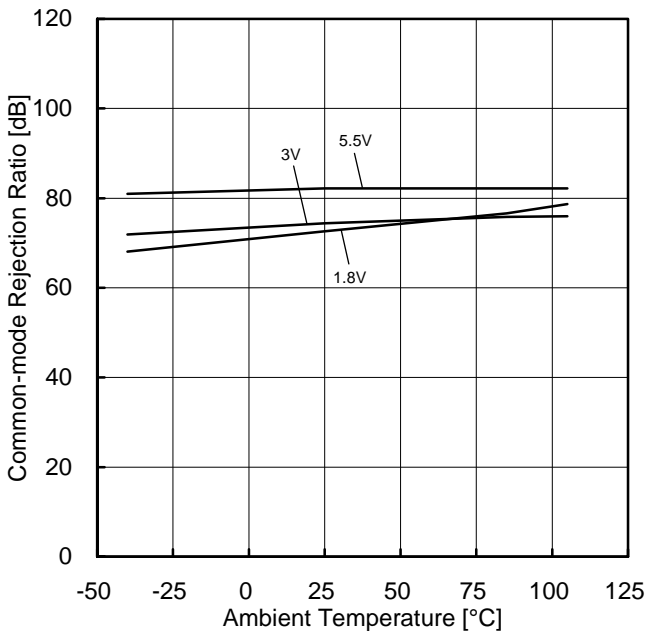

Figure 19.  
Common-mode Rejection Ratio vs Ambient Temperature (VDD=3V)

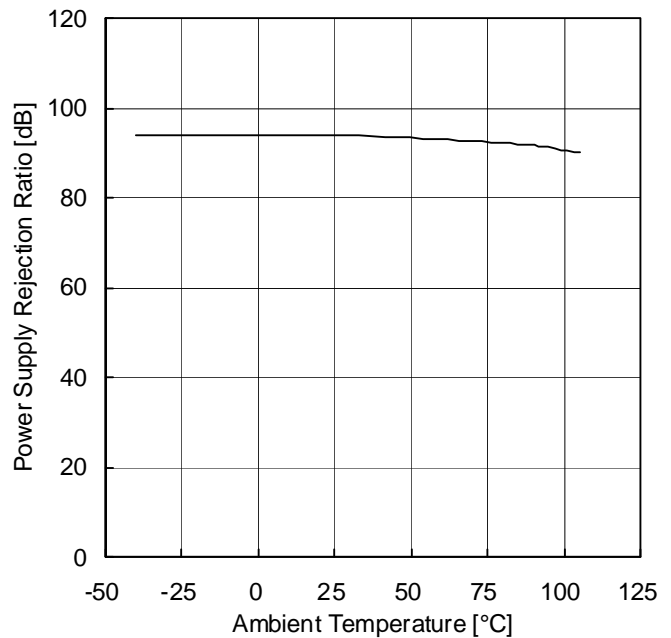

Figure 20.  
Power Supply Rejection Ratio vs Ambient Temperature

(\*) The above characteristics are measurements of typical sample, they are not guaranteed.  
BU7231G: -40°C to +85°C BU7231SG: -40°C to +105°C

Typical Performance Curves - continued

OBU7231G, BU7231SG

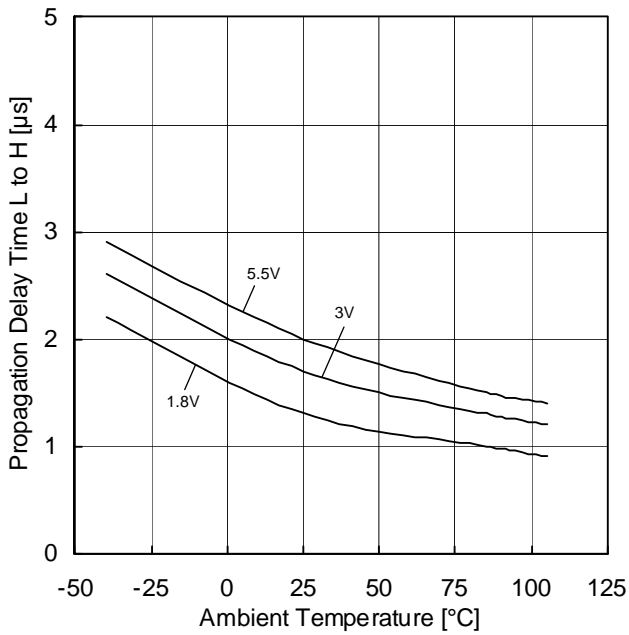

Figure 21.  
Propagation Delay Time L to H vs Ambient Temperature

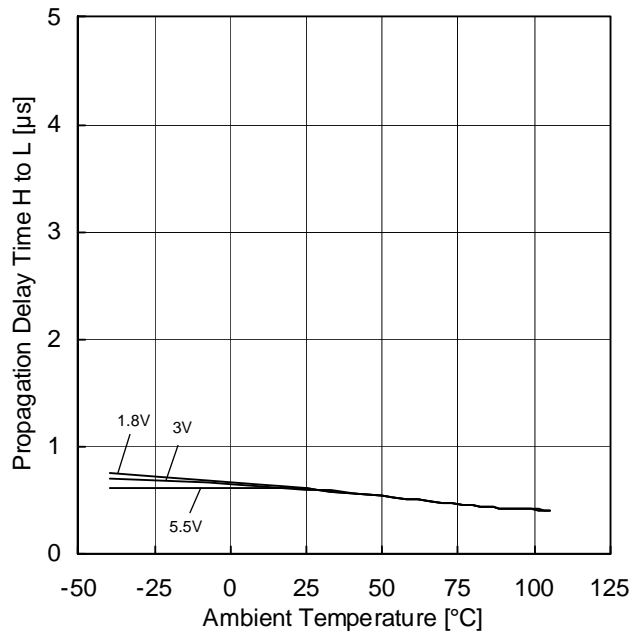

Figure 22.  
Propagation Delay Time H to L vs Ambient Temperature

(\*) The above characteristics are measurements of typical sample, they are not guaranteed.  
BU7231G: -40°C to +85°C BU7231SG: -40°C to +105°C

Typical Performance Curves - continued

OBU7232xxx, BU7232Sxxx

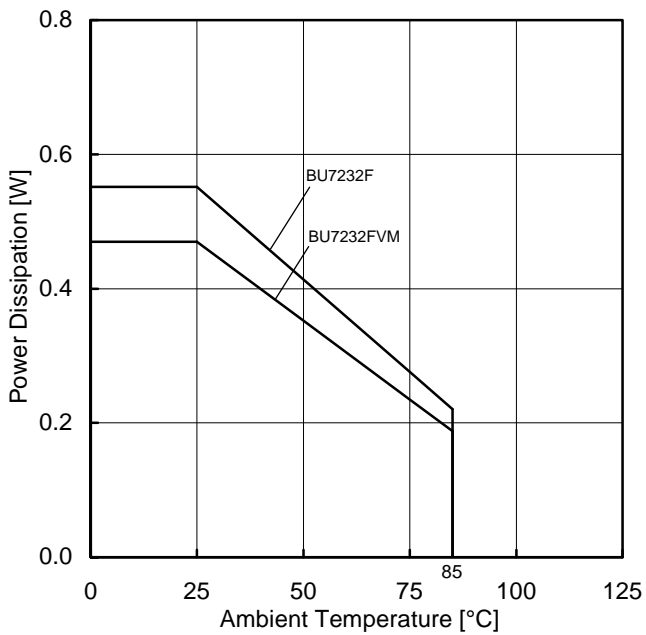

Figure 23.  
Power Dissipation vs Ambient Temperature  
(Derating Curve)

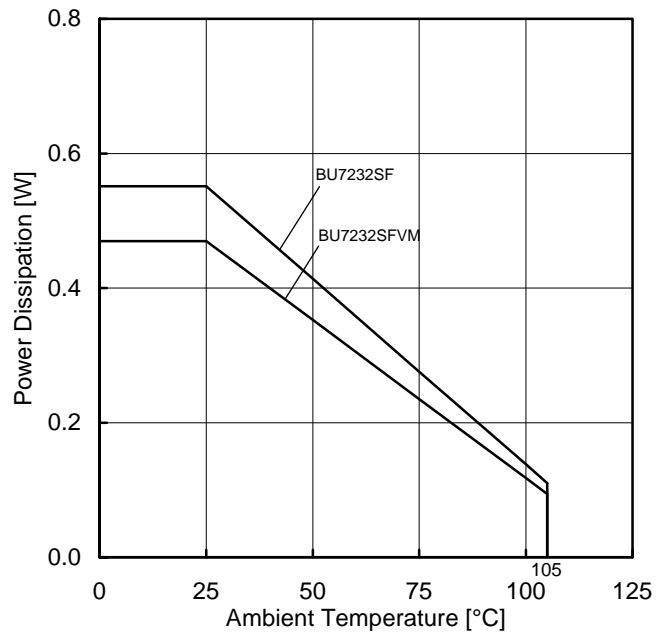

Figure 24.  
Power Dissipation vs Ambient Temperature  
(Derating Curve)

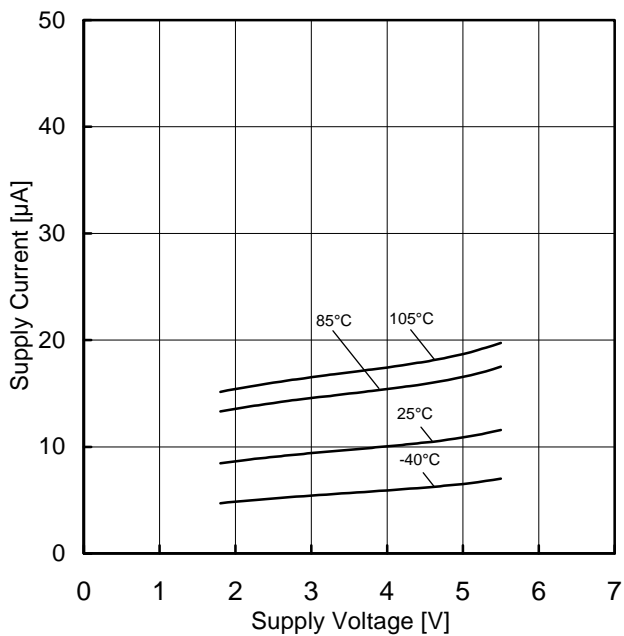

Figure 25.  
Supply Current vs Supply Voltage

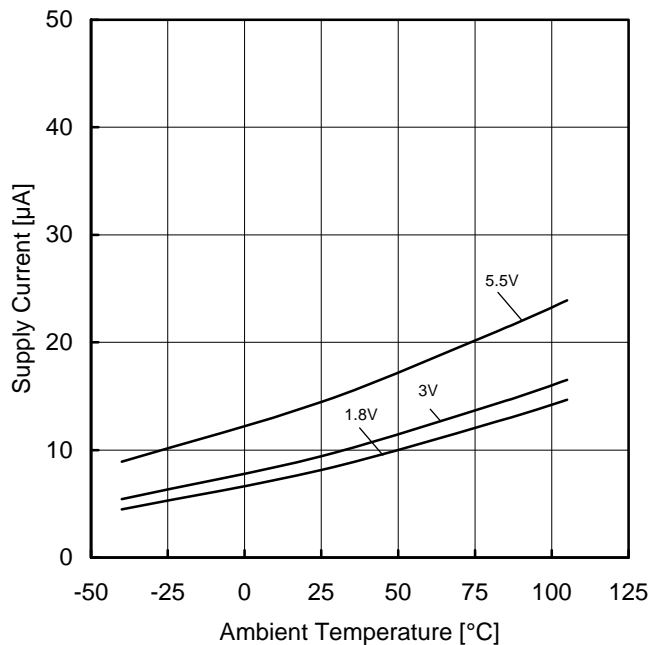

Figure 26.  
Supply Current vs Ambient Temperature

(\*) The above characteristics are measurements of typical sample, they are not guaranteed.  
BU7232xxx: -40°C to +85°C BU7232Sxxx: -40°C to +105°C

Typical Performance Curves - continued

OBU7232xxx, BU7232Sxxx

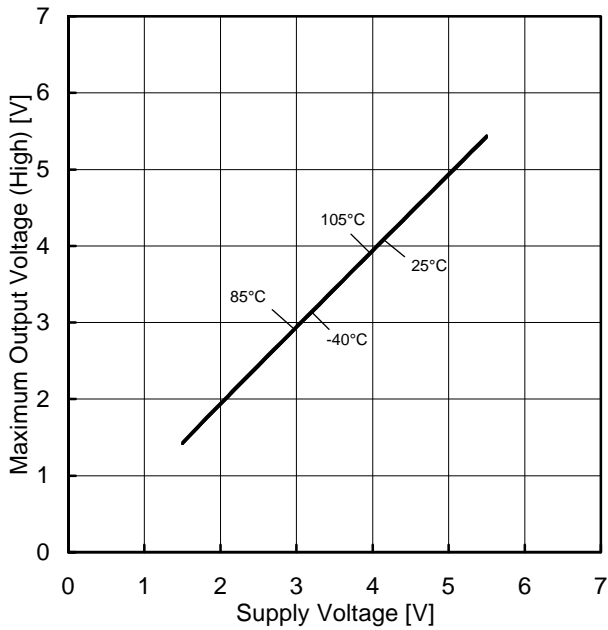

Figure 27.  
Maximum Output Voltage (High) vs Supply Voltage  
( $R_L=10k\Omega$ )

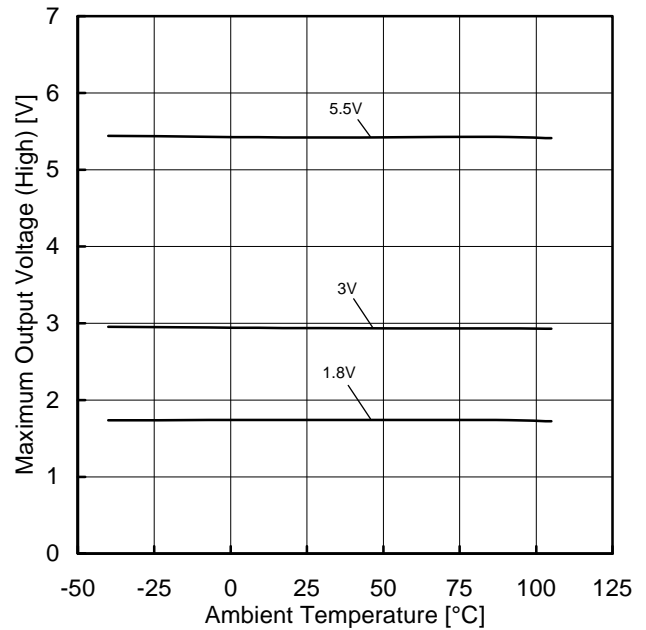

Figure 28.  
Maximum Output Voltage (High) vs Ambient Temperature  
( $R_L=10k\Omega$ )

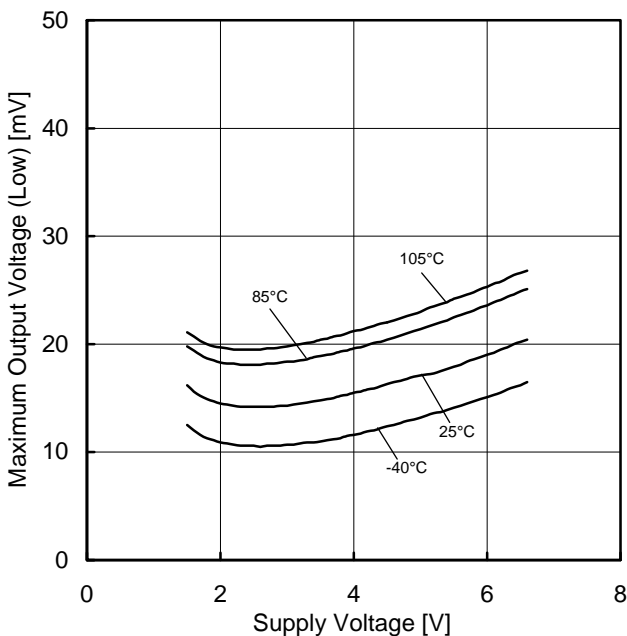

Figure 29.  
Maximum Output Voltage (Low) vs Supply Voltage  
( $R_L=10k\Omega$ )

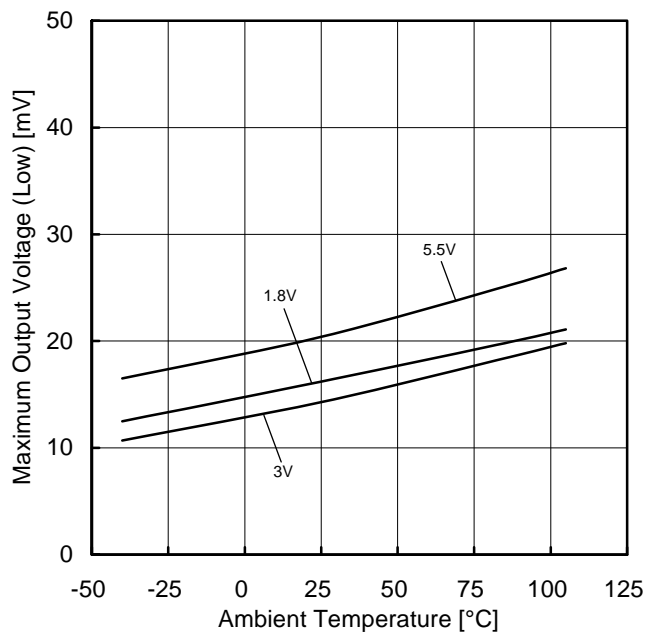

Figure 30.  
Maximum Output Voltage (Low) vs Ambient Temperature  
( $R_L=10k\Omega$ )

(\*) The above characteristics are measurements of typical sample, they are not guaranteed.  
BU7232xxx: -40°C to +85°C BU7232Sxxx: -40°C to +105°C

Typical Performance Curves - continued

OBU7232xxx, BU7232Sxxx

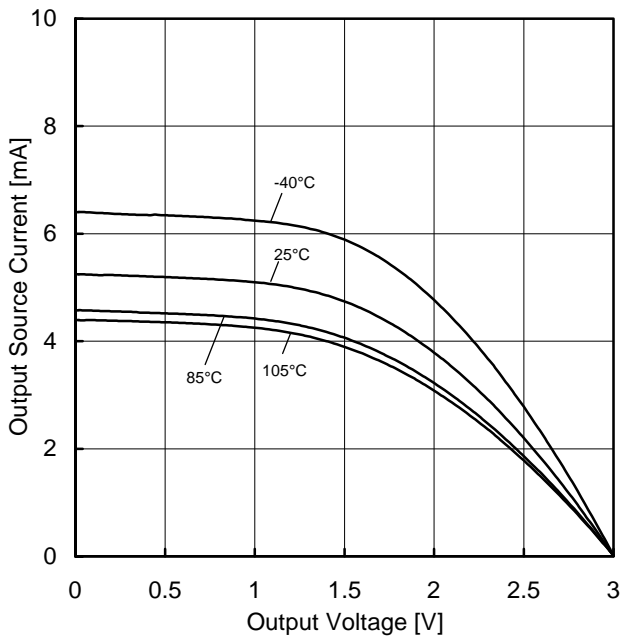

Figure 31.  
Output Source Current vs Output Voltage  
(VDD=3V)

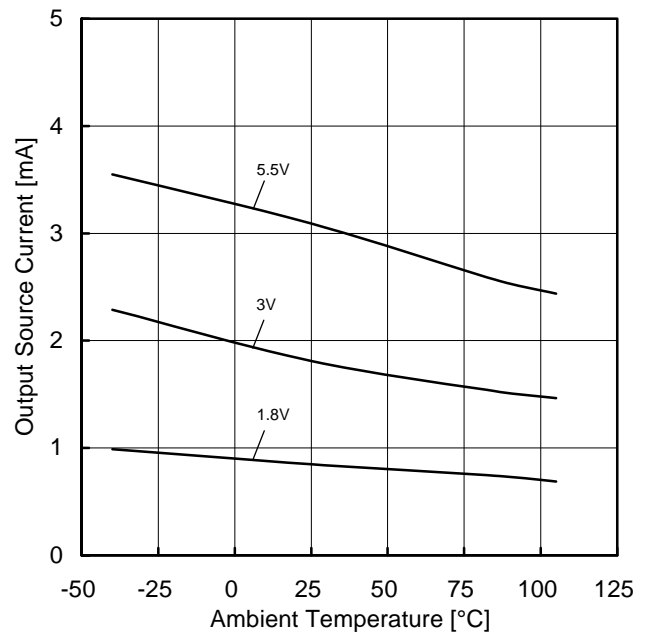

Figure 32.  
Output Source Current vs Ambient Temperature  
(OUT=VDD-0.4V)

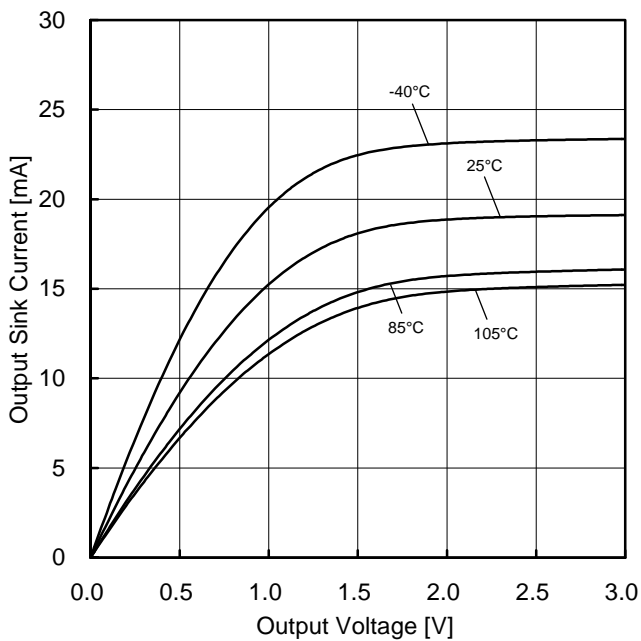

Figure 33.  
Output Sink Current vs Output Voltage  
(VDD=3V)

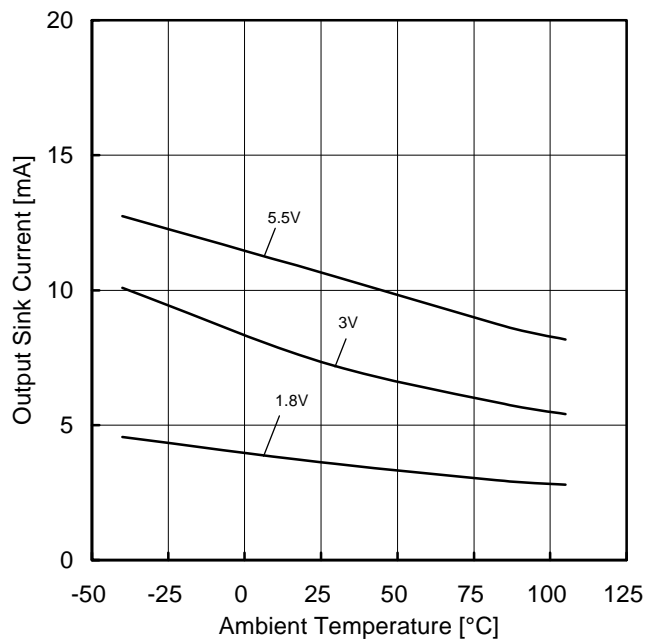

Figure 34.  
Output Sink Current vs Ambient Temperature  
(OUT=VSS+0.4V)

(\*) The above characteristics are measurements of typical sample, they are not guaranteed.  
BU7232xxx: -40°C to +85°C BU7232Sxxx: -40°C to +105°C

Typical Performance Curves - continued

OBU7232xxx, BU7232Sxxx

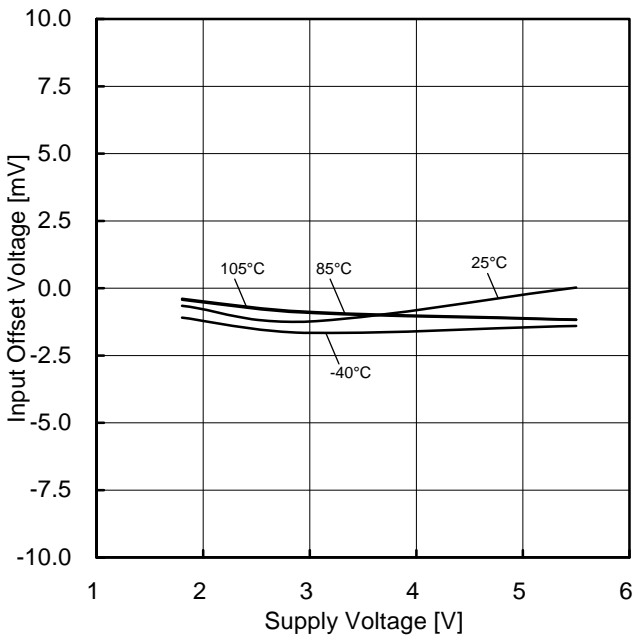

Figure 35.  
Input Offset Voltage vs Supply Voltage  
( $V_{ICM}=V_{DD}$ ,  $E_K=-V_{DD}/2$ )

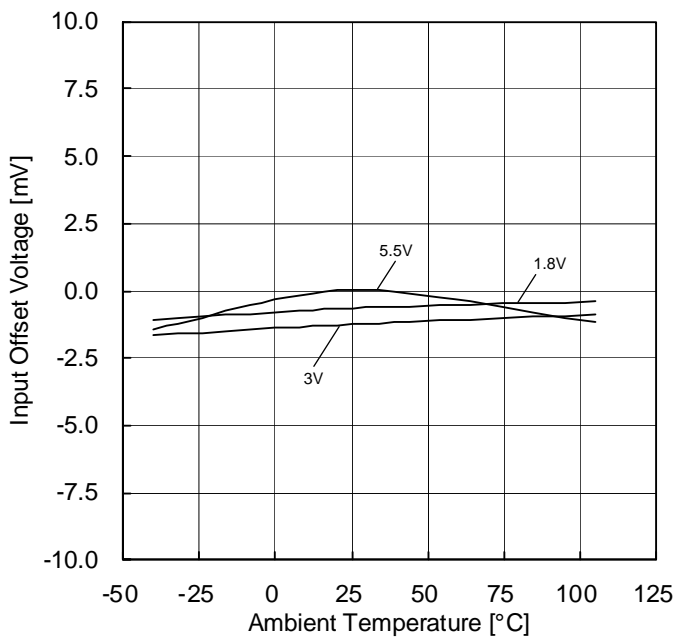

Figure 36.  
Input Offset Voltage vs Ambient Temperature  
( $V_{ICM}=V_{DD}$ ,  $E_K=-V_{DD}/2$ )

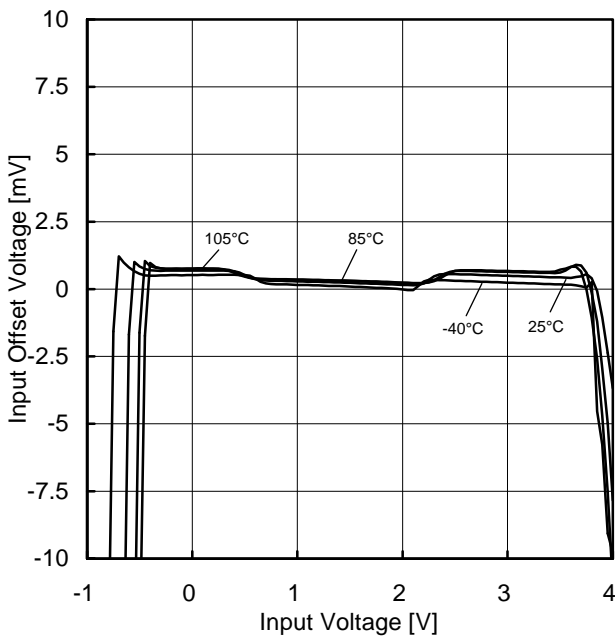

Figure 37.  
Input Offset Voltage vs Input Voltage  
( $V_{DD}=3V$ )

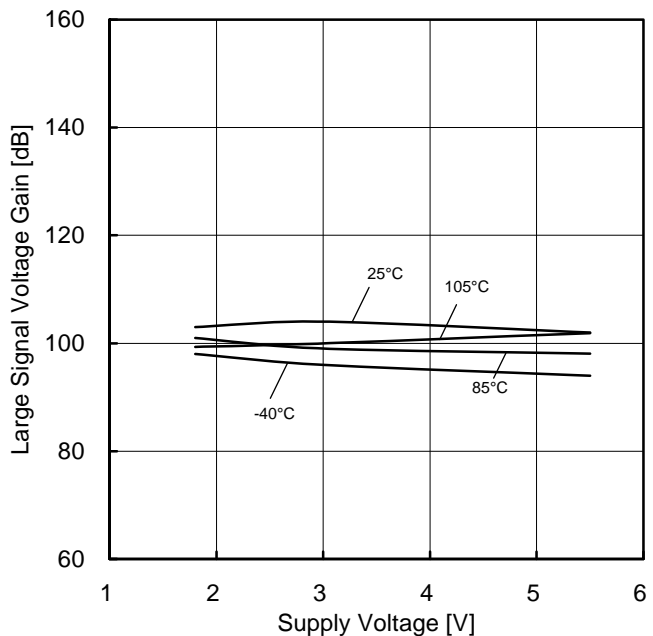

Figure 38.  
Large Signal Voltage Gain vs Supply Voltage

(\*) The above characteristics are measurements of typical sample, they are not guaranteed.  
BU7232xxx: -40°C to +85°C BU7232Sxxx: -40°C to +105°C

Typical Performance Curves - continued

OBU7232xxx, BU7232Sxxx

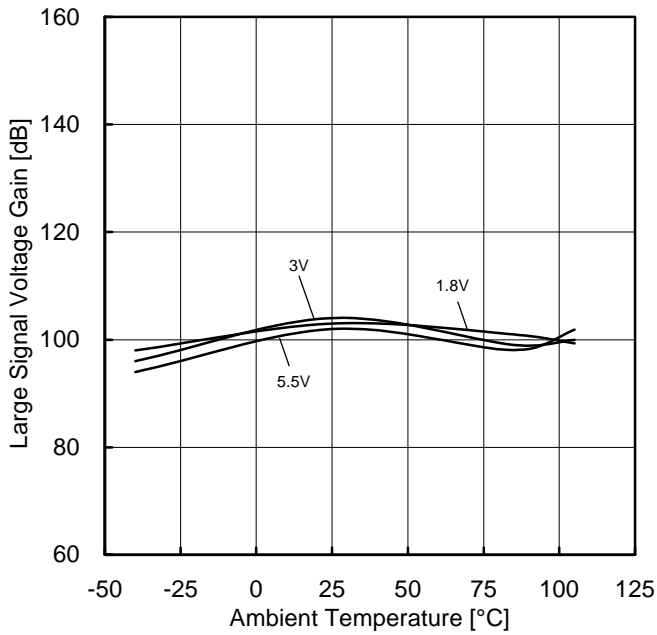

Figure 39.  
Large Signal Voltage Gain vs Ambient Temperature

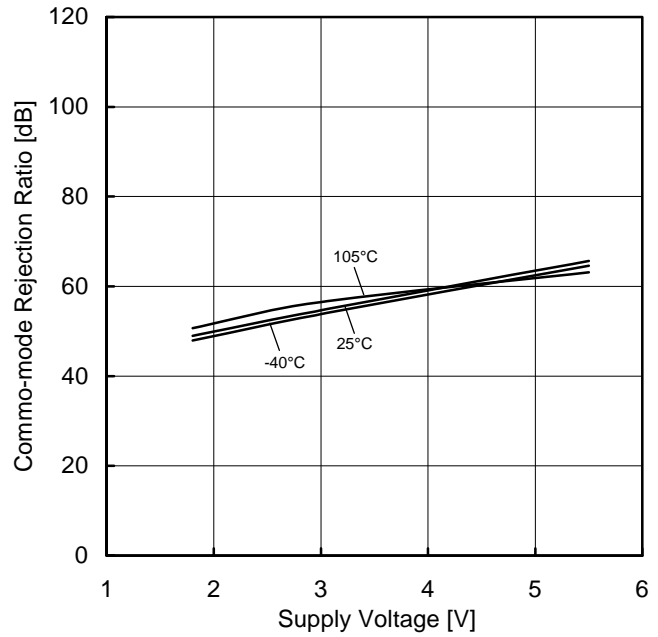

Figure 40.  
Common-mode Rejection Ratio vs Supply Voltage (VDD=3V)

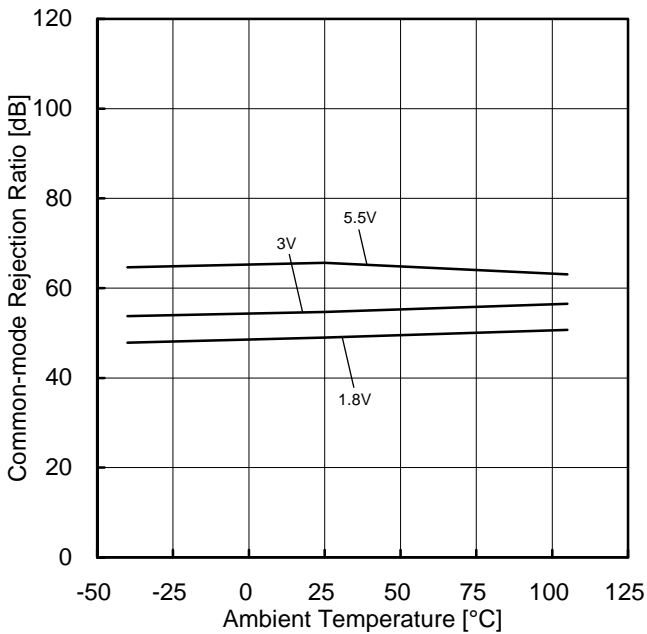

Figure 41.  
Common-mode Rejection Ratio vs Ambient Temperature (VDD=3V)

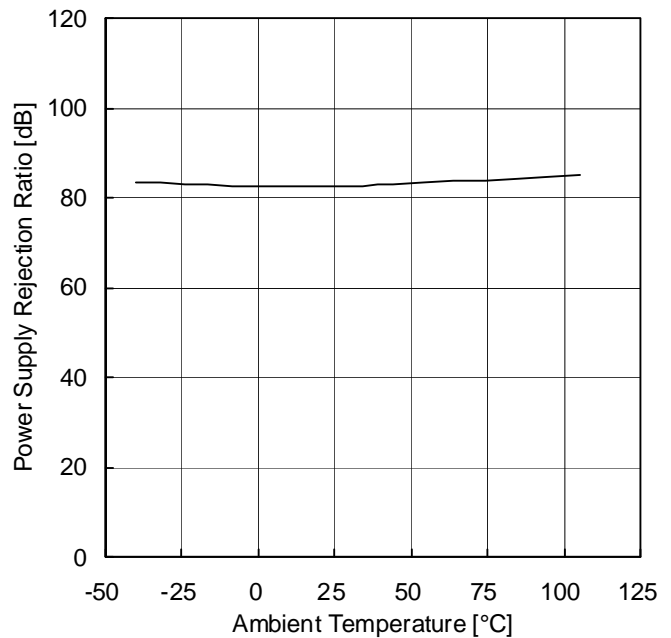

Figure 42.  
Power Supply Rejection Ratio vs Ambient Temperature

(\*) The above characteristics are measurements of typical sample, they are not guaranteed.  
BU7232xxx: -40°C to +85°C BU7232Sxxx: -40°C to +105°C



Typical Performance Curves - continued

OBU7232xxx, BU7232Sxxx

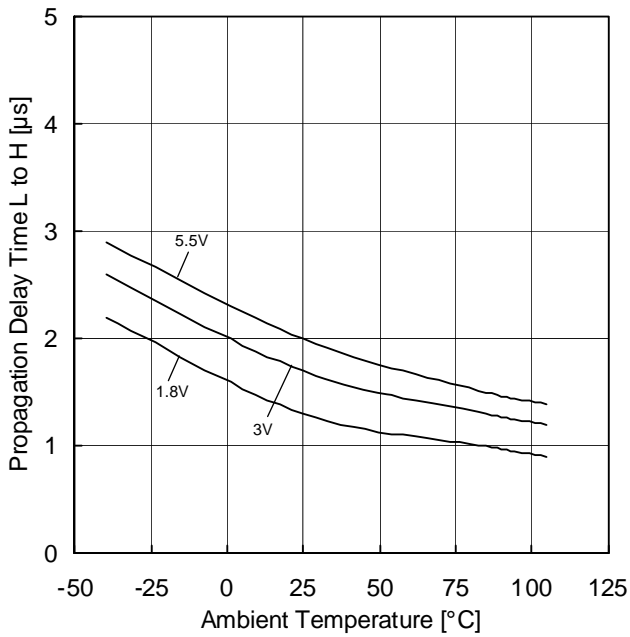

Figure 43.  
Propagation Delay L to H vs Ambient Temperature

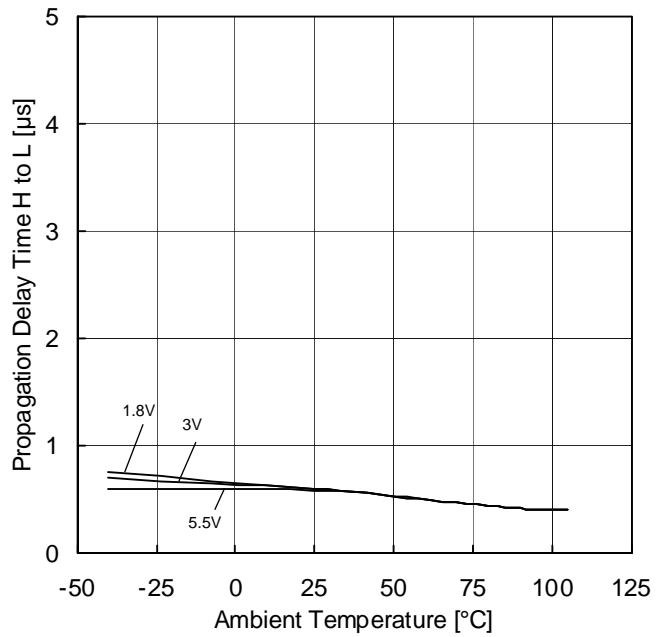

Figure 44.  
Propagation Delay H to L vs Ambient Temperature

(\*) The above characteristics are measurements of typical sample, they are not guaranteed.  
BU7232xxx: -40°C to +85°C BU7232Sxxx: -40°C to +105°C

**Application Information**  
**NULL Method Conditions for Test Circuit 1**

VDD, VSS, E<sub>K</sub>, V<sub>ICM</sub> Unit: V

Parameter	V <sub>F</sub>	SW1	SW2	SW3	VDD	VSS	E <sub>K</sub>	V <sub>ICM</sub>	Calculation
Input Offset Voltage	V <sub>F1</sub>	ON	ON	OFF	3	0	-0.1	0.3	1
Large Signal Voltage Gain	V <sub>F2</sub>	ON	ON	ON	3	0	-0.3	0.3	2
	V <sub>F3</sub>						-2.7		
Common-mode Rejection Ratio (Input Common-mode Voltage Range)	V <sub>F4</sub>	ON	ON	OFF	3	0	-0.1	0	3
	V <sub>F5</sub>						3		
Power Supply Rejection Ratio	V <sub>F6</sub>	ON	ON	OFF	1.8	0	-0.1	0.3	4
	V <sub>F7</sub>				5.5				

- Calculation -

1. Input Offset Voltage (V<sub>IO</sub>)

$$V_{IO} = \frac{|V_{F1}|}{1 + R_F/R_S} \quad [V]$$

2. Large Signal Voltage Gain (A<sub>v</sub>)

$$A_v = 20\text{Log} \frac{\Delta E_K \times (1 + R_F/R_S)}{|V_{F2} - V_{F3}|} \quad [dB]$$

3. Common-mode Rejection Ratio (CMRR)

$$\text{CMRR} = 20\text{Log} \frac{\Delta V_{ICM} \times (1 + R_F/R_S)}{|V_{F5} - V_{F4}|} \quad [dB]$$

4. Power Supply Rejection Ratio (PSRR)

$$\text{PSRR} = 20\text{Log} \frac{\Delta V_{DD} \times (1 + R_F/R_S)}{|V_{F7} - V_{F6}|} \quad [dB]$$

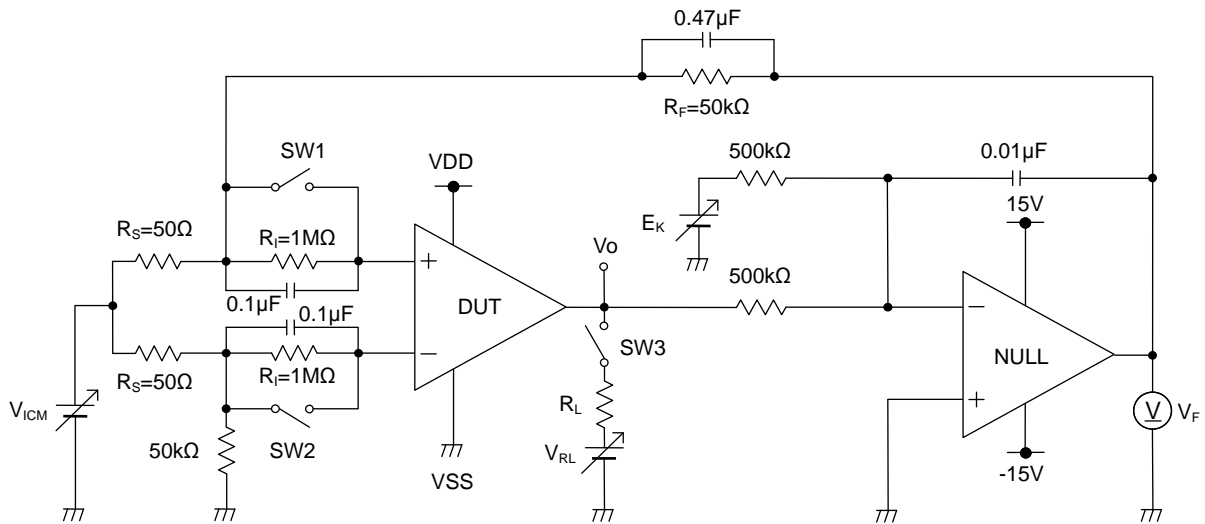

Figure 45. Test Circuit 1 (one channel only)

Switch Conditions for Test Circuit 2

SW No.	SW1	SW2	SW3	SW4	SW5	SW6	SW7	SW8
Supply Current	OFF	ON	ON	OFF	OFF	OFF	OFF	OFF
Maximum Output Voltage ( $R_L=10k\Omega$ )	OFF	ON	ON	ON	OFF	OFF	ON	OFF
Output Current	OFF	OFF	OFF	OFF	OFF	ON	OFF	OFF
Response Time	ON	OFF	ON	OFF	ON	OFF	OFF	ON

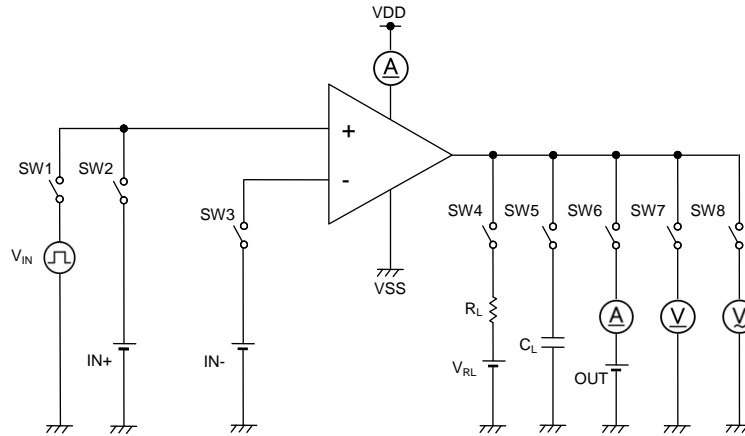

Figure 46. Test Circuit 2 (one channel only)

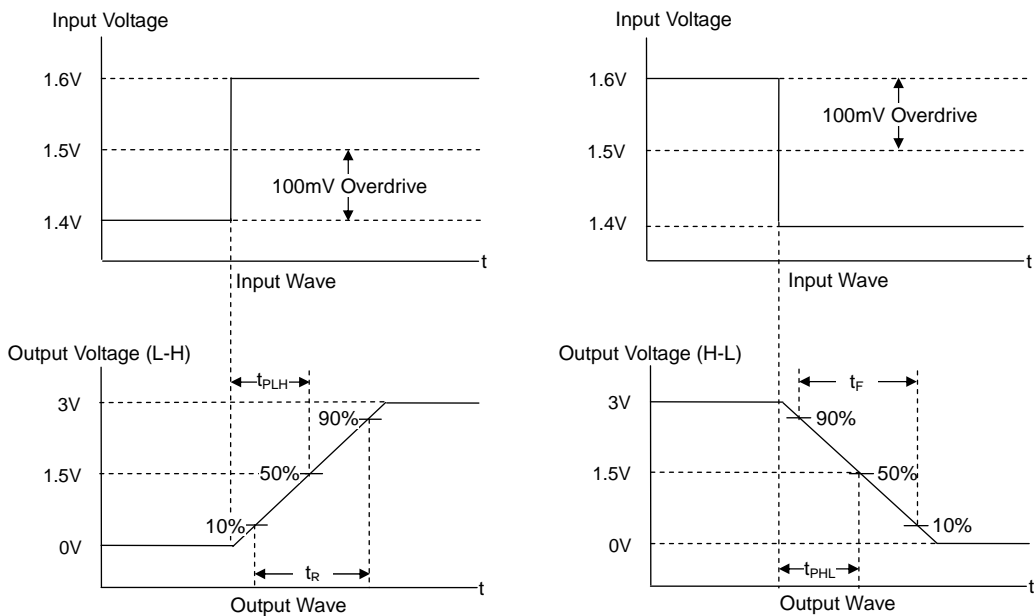

Figure 47. Response Time Input and Output Wave

**Power Dissipation**

Power dissipation (total loss) indicates the power that the IC can consume at  $T_A=25^\circ\text{C}$  (normal temperature). As the IC consumes power, it heats up, causing its temperature to be higher than the ambient temperature. The allowable temperature that the IC can accept is limited. This depends on the circuit configuration, manufacturing process, and consumable power.

Power dissipation is determined by the allowable temperature within the IC (maximum junction temperature) and the thermal resistance of the package used (heat dissipation capability). Maximum junction temperature is typically equal to the maximum storage temperature. The heat generated through the consumption of power by the IC radiates from the mold resin or lead frame of the package. Thermal resistance, represented by the symbol  $\theta_{JA}^\circ\text{C/W}$ , indicates this heat dissipation capability. Similarly, the temperature of an IC inside its package can be estimated by thermal resistance.

Figure 48(a) shows the model of the thermal resistance of a package. The equation below shows how to compute for the Thermal resistance ( $\theta_{JA}$ ), given the ambient temperature ( $T_A$ ), maximum junction temperature ( $T_{Jmax}$ ), and power dissipation ( $P_D$ ).

$$\theta_{JA} = (T_{Jmax} - T_A) / P_D \quad ^\circ\text{C/W}$$

The Derating curve in Figure 48(b) indicates the power that the IC can consume with reference to ambient temperature. Power consumption of the IC begins to attenuate at certain temperatures. This gradient is determined by Thermal resistance ( $\theta_{JA}$ ), which depends on the chip size, power consumption, package, ambient temperature, package condition, wind velocity, etc. This may also vary even when the same of package is used. Thermal reduction curve indicates a reference value measured at a specified condition. Figure 48(c) to (f) shows an example of the derating curve for BU7231G, BU7231SG, BU7232xxx, and BU7232Sxxx.

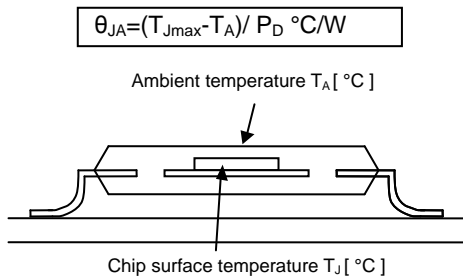

(a) Thermal Resistance

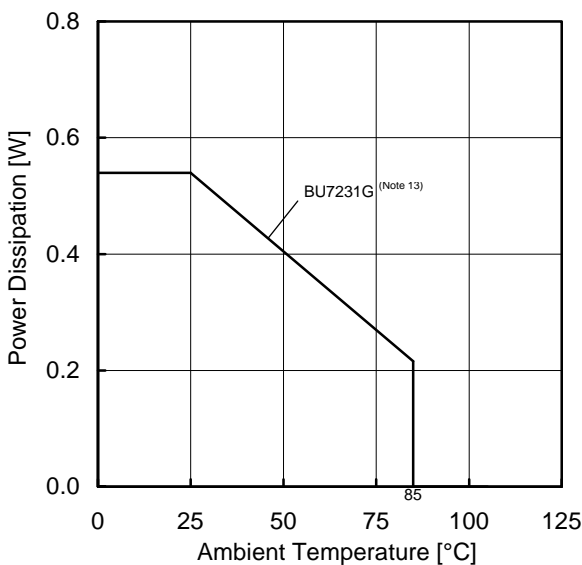
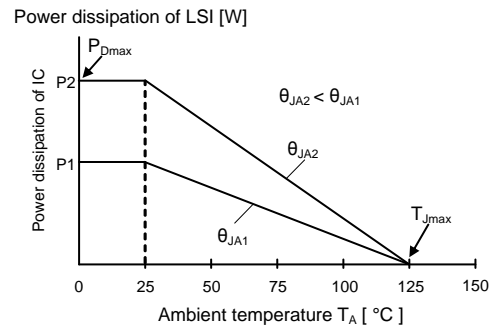

(c) BU7231G

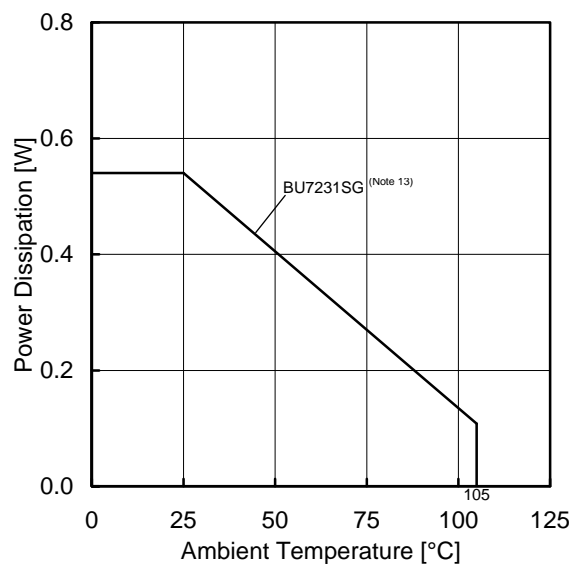

(d) BU7231SG

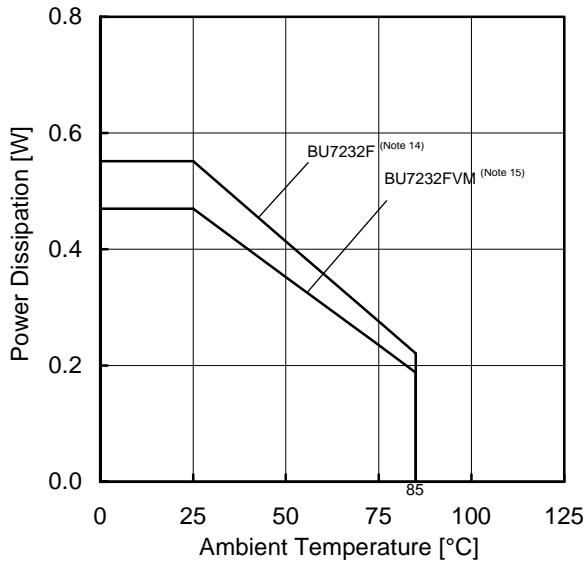

(e) BU7232xxx

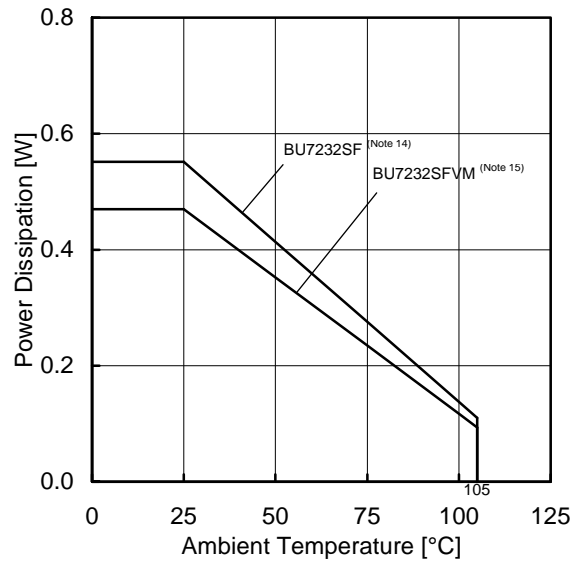

(f) BU7232Sxxx

Figure 48. Thermal Resistance and Derating Curve

(Note 13)	(Note 14)	(Note 15)	Unit
5.4	5.5	4.7	mW/°C

When using the unit above  $T_A = 25^\circ\text{C}$ , subtract the value above per Celsius degree. Power dissipation is the value when FR4 glass epoxy board 70mm × 70mm × 1.6mm (copper foil area less than 3%) is mounted.

## Operational Notes

### 1. Reverse Connection of Power Supply

Connecting the power supply in reverse polarity can damage the IC. Take precautions against reverse polarity when connecting the power supply, such as mounting an external diode between the power supply and the IC's power supply pins.

### 2. Power Supply Lines

Design the PCB layout pattern to provide low impedance supply lines. Separate the ground and supply lines of the digital and analog blocks to prevent noise in the ground and supply lines of the digital block from affecting the analog block. Furthermore, connect a capacitor to ground at all power supply pins. Consider the effect of temperature and aging on the capacitance value when using electrolytic capacitors.

### 3. Ground Voltage

Ensure that no pins are at a voltage below that of the ground pin at any time, even during transient condition.

### 4. Ground Wiring Pattern

When using both small-signal and large-current ground traces, the two ground traces should be routed separately but connected to a single ground at the reference point of the application board to avoid fluctuations in the small-signal ground caused by large currents. Also ensure that the ground traces of external components do not cause variations on the ground voltage. The ground lines must be as short and thick as possible to reduce line impedance.

### 5. Thermal Consideration

Should by any chance the power dissipation rating be exceeded the rise in temperature of the chip may result in deterioration of the properties of the chip. The absolute maximum rating of the  $P_D$  stated in this specification is when the IC is mounted on a 70mm x 70mm x 1.6mm glass epoxy board. In case of exceeding this absolute maximum rating, increase the board size and copper area to prevent exceeding the  $P_D$  rating.

### 6. Recommended Operating Conditions

These conditions represent a range within which the expected characteristics of the IC can be approximately obtained. The electrical characteristics are guaranteed under the conditions of each parameter.

### 7. Inrush Current

When power is first supplied to the IC, it is possible that the internal logic may be unstable and inrush current may flow instantaneously due to the internal powering sequence and delays, especially if the IC has more than one power supply. Therefore, give special consideration to power coupling capacitance, power wiring, width of ground wiring, and routing of connections.

### 8. Operation Under Strong Electromagnetic Field

Operating the IC in the presence of a strong electromagnetic field may cause the IC to malfunction.

### 9. Testing on Application Boards

When testing the IC on an application board, connecting a capacitor directly to a low-impedance output pin may subject the IC to stress. Always discharge capacitors completely after each process or step. The IC's power supply should always be turned off completely before connecting or removing it from the test setup during the inspection process. To prevent damage from static discharge, ground the IC during assembly and use similar precautions during transport and storage.

### 10. Inter-pin Short and Mounting Errors

Ensure that the direction and position are correct when mounting the IC on the PCB. Incorrect mounting may result in damaging the IC. Avoid nearby pins being shorted to each other especially to ground, power supply and output pin. Inter-pin shorts could be due to many reasons such as metal particles, water droplets (in very humid environment) and unintentional solder bridge deposited in between pins during assembly to name a few.

### 11. Unused Input Pins

Input pins of an IC are often connected to the gate of a MOS transistor. The gate has extremely high impedance and extremely low capacitance. If left unconnected, the electric field from the outside can easily charge it. The small charge acquired in this way is enough to produce a significant effect on the conduction through the transistor and cause unexpected operation of the IC. So unless otherwise specified, unused input pins should be connected to the power supply or ground line.

## Operational Notes – continued

**12. Regarding the Input Pin of the IC**

In the construction of this IC, P-N junctions are inevitably formed creating parasitic diodes or transistors. The operation of these parasitic elements can result in mutual interference among circuits, operational faults, or physical damage. Therefore, conditions which cause these parasitic elements to operate, such as applying a voltage to an input pin lower than the ground voltage should be avoided. Furthermore, do not apply a voltage to the input pins when no power supply voltage is applied to the IC. Even if the power supply voltage is applied, make sure that the input pins have voltages within the values specified in the electrical characteristics of this IC.

**13. Unused Circuits**

When there are unused comparators, it is recommended that they are connected as in Figure 49, setting the non-inverting input terminal to the VDD, inverting input terminal to the VSS.

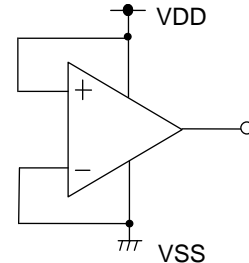

Figure 49. Example of Application Circuit for Unused Comparator

**14. Input Voltage**

Applying  $VDD+0.3V$  to the input terminal is possible without causing deterioration of the electrical characteristics or destruction, regardless of the supply voltage. However, this does not ensure normal circuit operation. Please note that the circuit operates normally only when the input voltage is within the common mode input voltage range of the electric characteristics.

**15. Power Supply(single/dual)**

The voltage comparator operates when the voltage supplied is between VDD and VSS. Therefore, the single supply voltage comparator can be used as dual supply voltage comparator as well.

**16. Output Capacitor**

If a large capacitor is connected between the output pin and VSS pin, current from the charged capacitor will flow into the output pin and may destroy the IC when the VDD pin is shorted to ground or pulled down to 0V. Use a capacitor smaller than  $0.1\mu F$  between output pin and VSS pin.

**17. Oscillation by Output Capacitor**

Please pay attention to the oscillation by output capacitor and in designing an application of negative feedback loop circuit with these ICs.

**18. Latch up**

Be careful of input voltage that exceed the VDD and VSS. When CMOS device have sometimes occur latch up and protect the IC from abnormal noise.

Physical Dimensions Tape and Reel Information

Package Name	SSOP5
--------------	-------

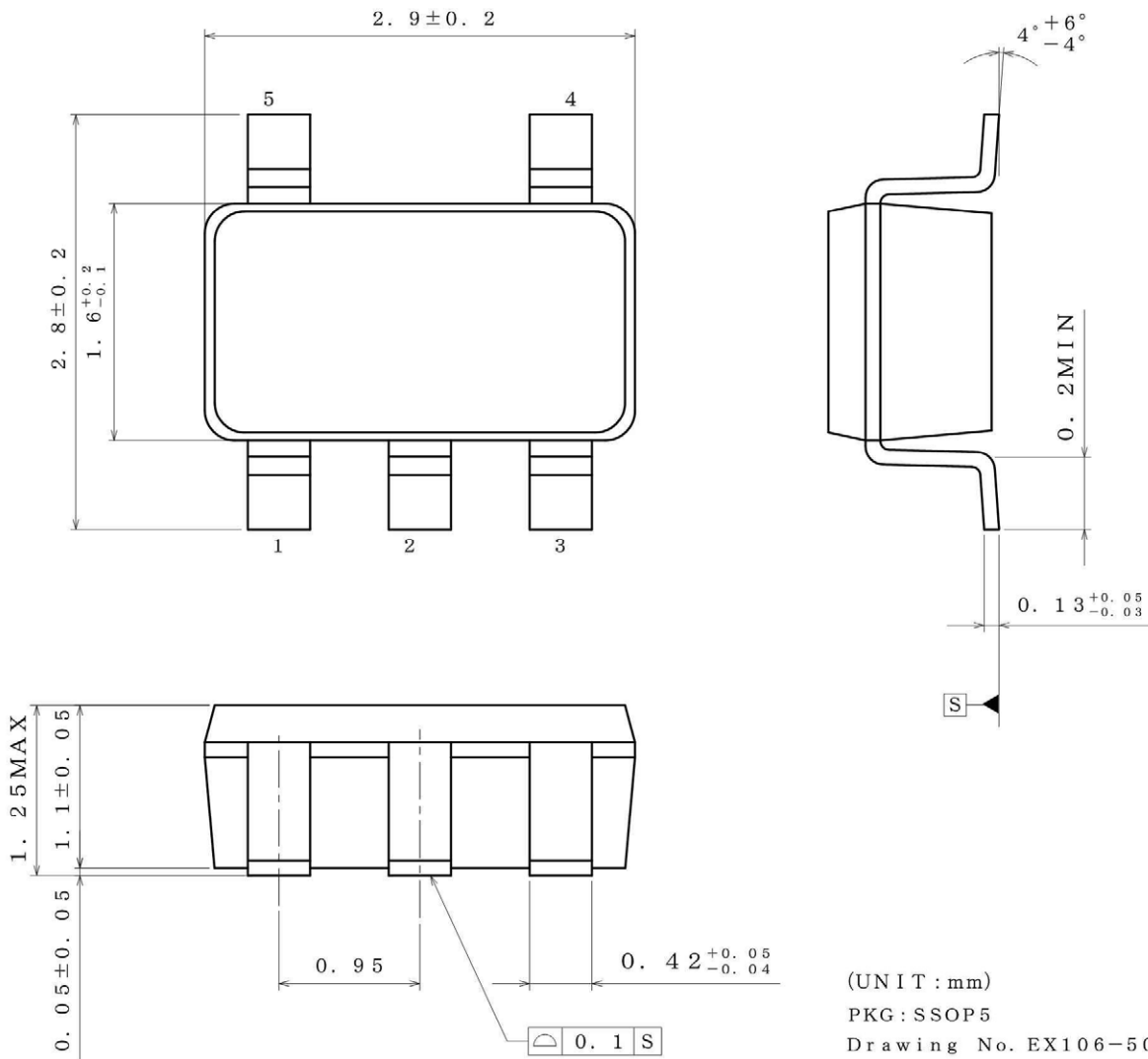

< Tape and Reel Information >

Tape	Embossed carrier tape
Quantity	3000pcs
Direction of feed	TR ( The direction is the 1pin of product is at the upper right when you hold ) reel on the left hand and you pull out the tape on the right hand

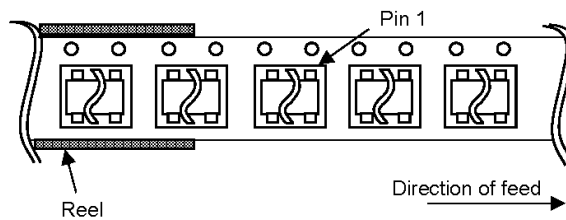



Physical Dimensions Tape and Reel Information – continued

Package Name	SOP8
--------------	------

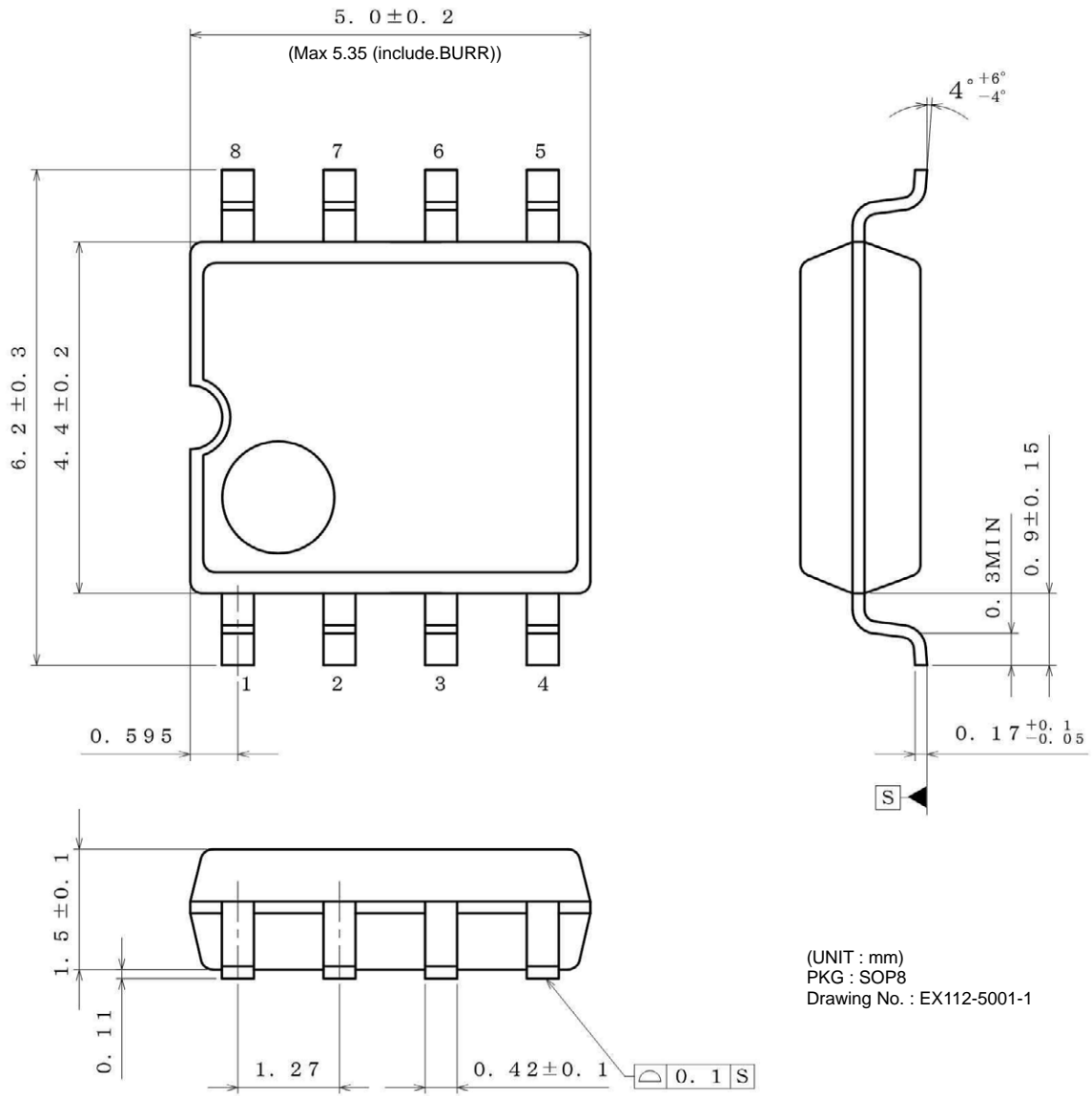

(UNIT : mm)  
 PKG : SOP8  
 Drawing No. : EX112-5001-1

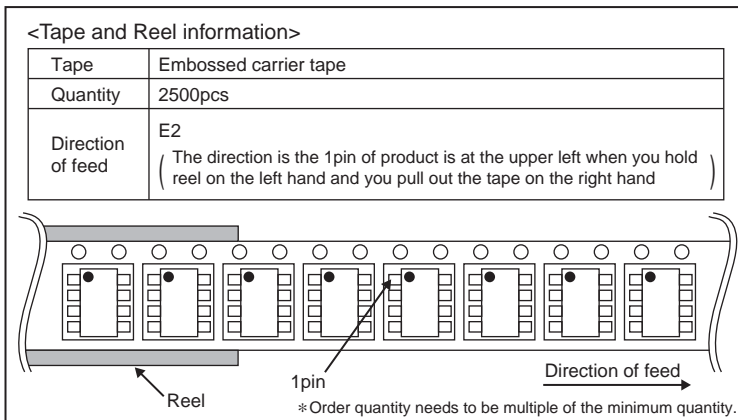

Physical Dimensions Tape and Reel Information - continued

Package Name	MSOP8
--------------	-------

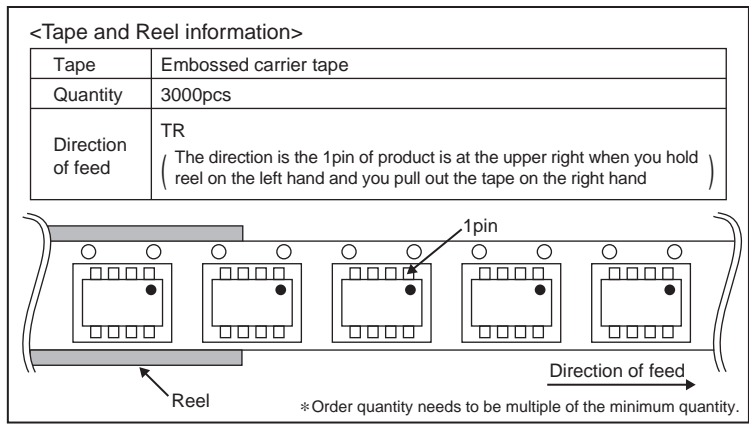
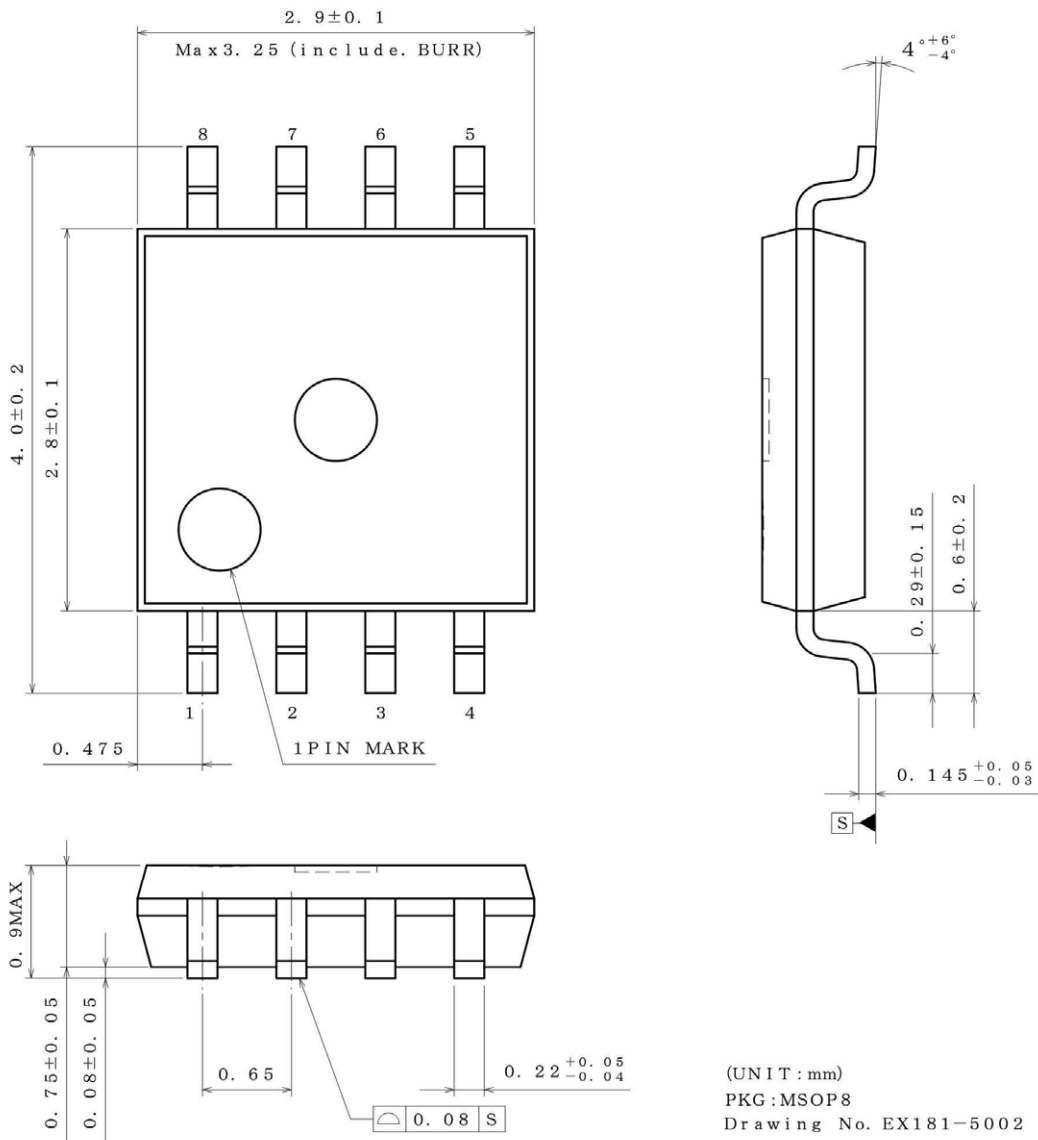

Marking Diagram

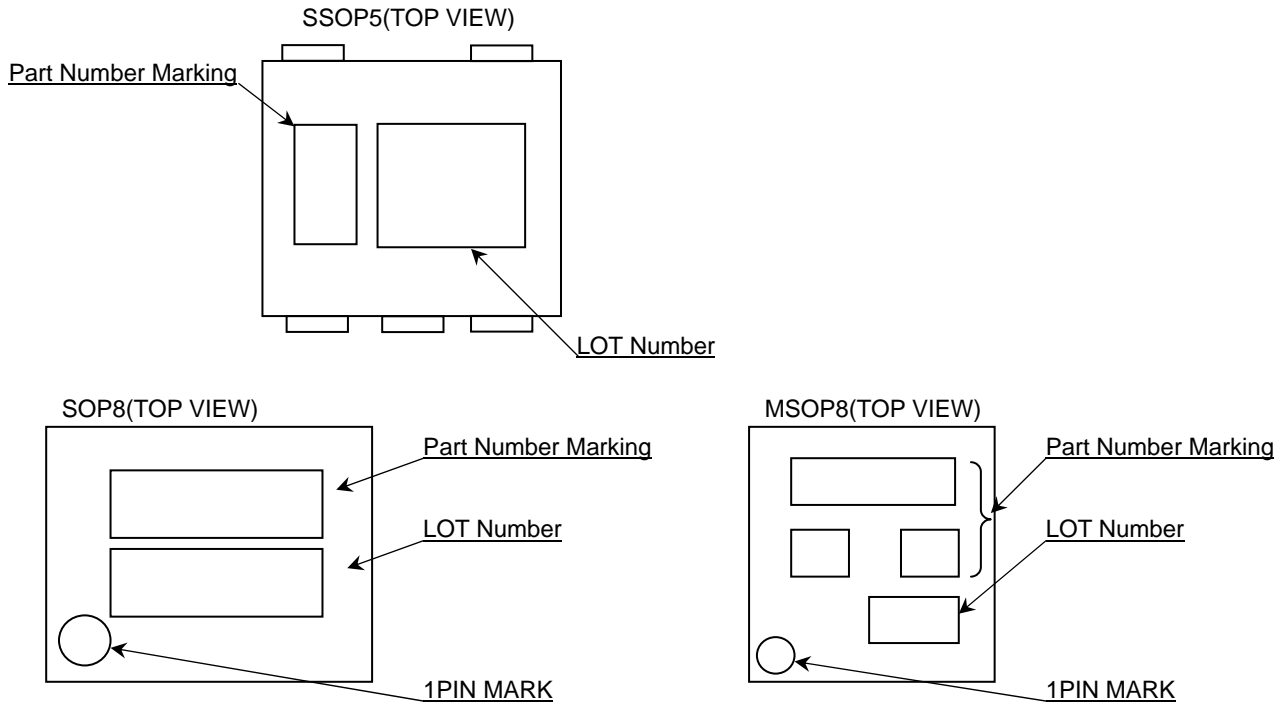

Product Name		Package Type	Marking
BU7231	G	SSOP5	AM
BU7231S			AY
BU7232	F	SOP8	7232
	FVM	MSOP8	
BU7232S	F	SOP8	7232S
	FVM	MSOP8	

Land Pattern Data

All dimensions in mm

Package	Land pitch e	Land space MIE	Land length $\geq \ell 2$	Land width b2
SSOP5	0.95	2.4	1.0	0.6
SOP8	1.27	4.60	1.10	0.76
MSOP8	0.65	2.62	0.99	0.35

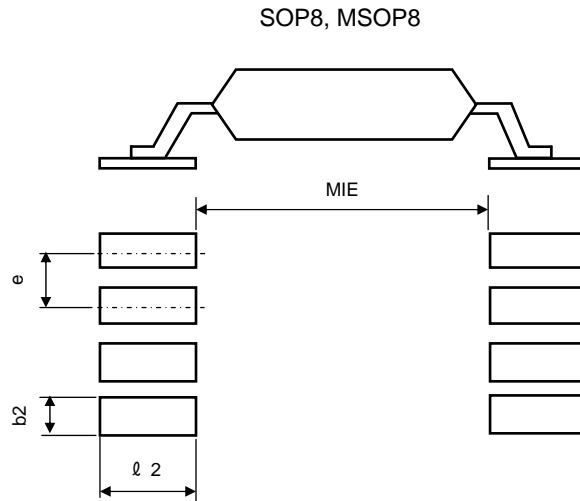
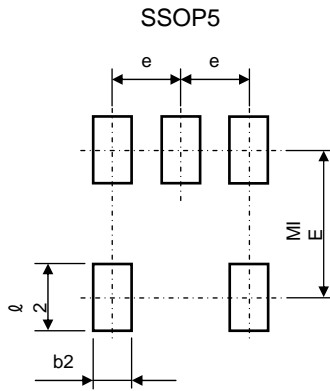

Revision History

Date	Revision	Changes
25.Nov.2013	001	New Release

# Notice

## Precaution on using ROHM Products

- Our Products are designed and manufactured for application in ordinary electronic equipments (such as AV equipment, OA equipment, telecommunication equipment, home electronic appliances, amusement equipment, etc.). If you intend to use our Products in devices requiring extremely high reliability (such as medical equipment <sup>(Note 1)</sup>, transport equipment, traffic equipment, aircraft/spacecraft, nuclear power controllers, fuel controllers, car equipment including car accessories, safety devices, etc.) and whose malfunction or failure may cause loss of human life, bodily injury or serious damage to property ("Specific Applications"), please consult with the ROHM sales representative in advance. Unless otherwise agreed in writing by ROHM in advance, ROHM shall not be in any way responsible or liable for any damages, expenses or losses incurred by you or third parties arising from the use of any ROHM's Products for Specific Applications.

(Note1) Medical Equipment Classification of the Specific Applications

JAPAN	USA	EU	CHINA
CLASS III	CLASS III	CLASS II b	CLASS III
CLASS IV		CLASS III	

- ROHM designs and manufactures its Products subject to strict quality control system. However, semiconductor products can fail or malfunction at a certain rate. Please be sure to implement, at your own responsibilities, adequate safety measures including but not limited to fail-safe design against the physical injury, damage to any property, which a failure or malfunction of our Products may cause. The following are examples of safety measures:
  - Installation of protection circuits or other protective devices to improve system safety
  - Installation of redundant circuits to reduce the impact of single or multiple circuit failure
- Our Products are designed and manufactured for use under standard conditions and not under any special or extraordinary environments or conditions, as exemplified below. Accordingly, ROHM shall not be in any way responsible or liable for any damages, expenses or losses arising from the use of any ROHM's Products under any special or extraordinary environments or conditions. If you intend to use our Products under any special or extraordinary environments or conditions (as exemplified below), your independent verification and confirmation of product performance, reliability, etc. prior to use, must be necessary:
  - Use of our Products in any types of liquid, including water, oils, chemicals, and organic solvents
  - Use of our Products outdoors or in places where the Products are exposed to direct sunlight or dust
  - Use of our Products in places where the Products are exposed to sea wind or corrosive gases, including Cl<sub>2</sub>, H<sub>2</sub>S, NH<sub>3</sub>, SO<sub>2</sub>, and NO<sub>2</sub>
  - Use of our Products in places where the Products are exposed to static electricity or electromagnetic waves
  - Use of our Products in proximity to heat-producing components, plastic cords, or other flammable items
  - Sealing or coating our Products with resin or other coating materials
  - Use of our Products without cleaning residue of flux (even if you use no-clean type fluxes, cleaning residue of flux is recommended); or Washing our Products by using water or water-soluble cleaning agents for cleaning residue after soldering
  - Use of the Products in places subject to dew condensation
- The Products are not subject to radiation-proof design.
- Please verify and confirm characteristics of the final or mounted products in using the Products.
- In particular, if a transient load (a large amount of load applied in a short period of time, such as pulse. is applied, confirmation of performance characteristics after on-board mounting is strongly recommended. Avoid applying power exceeding normal rated power; exceeding the power rating under steady-state loading condition may negatively affect product performance and reliability.
- De-rate Power Dissipation (Pd) depending on Ambient temperature (Ta). When used in sealed area, confirm the actual ambient temperature.
- Confirm that operation temperature is within the specified range described in the product specification.
- ROHM shall not be in any way responsible or liable for failure induced under deviant condition from what is defined in this document.

## Precaution for Mounting / Circuit board design

- When a highly active halogenous (chlorine, bromine, etc.) flux is used, the residue of flux may negatively affect product performance and reliability.
- In principle, the reflow soldering method must be used; if flow soldering method is preferred, please consult with the ROHM representative in advance.

For details, please refer to ROHM Mounting specification

### Precautions Regarding Application Examples and External Circuits

1. If change is made to the constant of an external circuit, please allow a sufficient margin considering variations of the characteristics of the Products and external components, including transient characteristics, as well as static characteristics.
2. You agree that application notes, reference designs, and associated data and information contained in this document are presented only as guidance for Products use. Therefore, in case you use such information, you are solely responsible for it and you must exercise your own independent verification and judgment in the use of such information contained in this document. ROHM shall not be in any way responsible or liable for any damages, expenses or losses incurred by you or third parties arising from the use of such information.

### Precaution for Electrostatic

This Product is electrostatic sensitive product, which may be damaged due to electrostatic discharge. Please take proper caution in your manufacturing process and storage so that voltage exceeding the Products maximum rating will not be applied to Products. Please take special care under dry condition (e.g. Grounding of human body / equipment / solder iron, isolation from charged objects, setting of Ionizer, friction prevention and temperature / humidity control).

### Precaution for Storage / Transportation

1. Product performance and soldered connections may deteriorate if the Products are stored in the places where:
  - [a] the Products are exposed to sea winds or corrosive gases, including Cl<sub>2</sub>, H<sub>2</sub>S, NH<sub>3</sub>, SO<sub>2</sub>, and NO<sub>2</sub>
  - [b] the temperature or humidity exceeds those recommended by ROHM
  - [c] the Products are exposed to direct sunshine or condensation
  - [d] the Products are exposed to high Electrostatic
2. Even under ROHM recommended storage condition, solderability of products out of recommended storage time period may be degraded. It is strongly recommended to confirm solderability before using Products of which storage time is exceeding the recommended storage time period.
3. Store / transport cartons in the correct direction, which is indicated on a carton with a symbol. Otherwise bent leads may occur due to excessive stress applied when dropping of a carton.
4. Use Products within the specified time after opening a humidity barrier bag. Baking is required before using Products of which storage time is exceeding the recommended storage time period.

### Precaution for Product Label

QR code printed on ROHM Products label is for ROHM's internal use only.

### Precaution for Disposition

When disposing Products please dispose them properly using an authorized industry waste company.

### Precaution for Foreign Exchange and Foreign Trade act

Since our Products might fall under controlled goods prescribed by the applicable foreign exchange and foreign trade act, please consult with ROHM representative in case of export.

### Precaution Regarding Intellectual Property Rights

1. All information and data including but not limited to application example contained in this document is for reference only. ROHM does not warrant that foregoing information or data will not infringe any intellectual property rights or any other rights of any third party regarding such information or data. ROHM shall not be in any way responsible or liable for infringement of any intellectual property rights or other damages arising from use of such information or data.:
2. No license, expressly or implied, is granted hereby under any intellectual property rights or other rights of ROHM or any third parties with respect to the information contained in this document.

### Other Precaution

1. This document may not be reprinted or reproduced, in whole or in part, without prior written consent of ROHM.
2. The Products may not be disassembled, converted, modified, reproduced or otherwise changed without prior written consent of ROHM.
3. In no event shall you use in any way whatsoever the Products and the related technical information contained in the Products or this document for any military purposes, including but not limited to, the development of mass-destruction weapons.
4. The proper names of companies or products described in this document are trademarks or registered trademarks of ROHM, its affiliated companies or third parties.

**General Precaution**

1. Before you use our Products, you are requested to carefully read this document and fully understand its contents. ROHM shall not be in any way responsible or liable for failure, malfunction or accident arising from the use of any ROHM's Products against warning, caution or note contained in this document.
2. All information contained in this document is current as of the issuing date and subject to change without any prior notice. Before purchasing or using ROHM's Products, please confirm the latest information with a ROHM sales representative.
3. The information contained in this document is provided on an "as is" basis and ROHM does not warrant that all information contained in this document is accurate and/or error-free. ROHM shall not be in any way responsible or liable for any damages, expenses or losses incurred by you or third parties resulting from inaccuracy or errors of or concerning such information.