

SPDT SWITCH GaAs MMIC

■ GENERAL DESCRIPTION

The NJG1608KB2 is a SPDT switch IC featured low insertion loss, medium handling power and high isolation.

The NJG1608KB2 is suitable for switching of Tx/Rx signals at sub-microwave applications. The NJG1608KB2 exhibits wide frequency range from 100MHz to 6.0GHz at low operating voltage of 2.5V, and is operated up to 25dBm at 3.0V operating voltage.

The Pb free FLP6-B2 package is applied.

■ PACKAGE OUTLINE

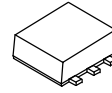

NJG1608KB2

■ FEATURES

- Single low voltage control +2.5~+6.5V
- Low insertion loss
 - 0.30dB typ. @f=2.0GHz
 - 0.35dB typ. @f=2.5GHz
 - 0.60dB typ. @f=5.85GHz
- High isolation
 - 29dB typ. @f=2.0GHz
 - 30dB typ. @f=2.5GHz
 - 18dB typ. @f=5.85GHz
- Handling power $P_{-1dB}=30\text{dBm}$ typ. @f=2.5GHz, $V_{CTL}=3.0\text{V}$
- Ultra-small and ultra-thin package FLP6-B2 (Package size: 2.0mmx2.1mmx0.75mm typ.)

■ PIN CONFIGURATION

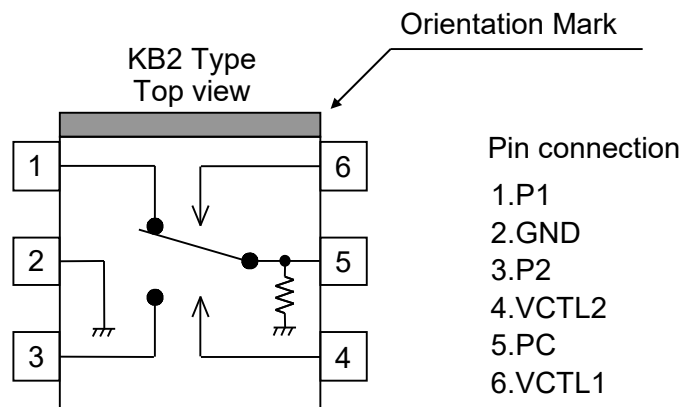

■ TRUTH TABLE

“H”= $V_{CTL(H)}$, “L”= $V_{CTL(L)}$

V_{CTL1}	H	L
V_{CTL2}	L	H
PC – P1	OFF	ON
PC – P2	ON	OFF

NJG1608KB2

■ ABSOLUTE MAXIMUM RATINGS

($T_a=25^{\circ}\text{C}$, $Z_s=Z_l=50\Omega$)

PARAMETER	SYMBOL	CONDITIONS	RATINGS	UNITS
Input Power	P_{in}	$V_{CTL(L)}=0\text{V}$, $V_{CTL(H)}=3.0\text{V}$	32	dBm
Control Voltage	V_{CTL}	$V_{CTL(H)}-V_{CTL(L)}$	7.5	V
Power Dissipation	P_D	on PCB board	550	mW
Operating Temp.	T_{opr}		-40~+85	$^{\circ}\text{C}$
Storage Temp.	T_{stg}		-55~+150	$^{\circ}\text{C}$

■ ELECTRICAL CHARACTERISTICS

(with application circuit, $V_{CTL(L)}=0\text{V}$, $V_{CTL(H)}=3.0\text{V}$, $Z_s=Z_l=50\Omega$, $T_a=25^{\circ}\text{C}$)

PARAMETERS	SYMBOL	CONDITIONS	MIN	TYP	MAX	UNITS
Operating voltage (LOW)	$V_{CTL(L)}$		-0.2	0	0.2	V
Operating voltage (HIGH)	$V_{CTL(H)}$		2.5	3.0	6.5	V
Control current	I_{CTL}	$f=2.0\text{GHz}$	-	5	10	μA
Insertion loss 1	LOSS1	$f=2.0\text{GHz}$	-	0.30	0.45	dB
Insertion loss 2	LOSS2	$f=2.5\text{GHz}$	-	0.35	0.50	dB
Insertion loss 3	LOSS3	$f=5.85\text{GHz}$		0.60	0.80	dB
Isolation 1 (PC-P1, PC-P2, P1-P2)	ISL1	$f=2.0\text{GHz}$,	26	29	-	dB
Isolation 2 (PC-P1, PC-P2, P1-P2)	ISL2	$f=2.5\text{GHz}$,	27	30	-	dB
Isolation 3 (PC-P1, PC-P2, P1-P2)	ISL3	$f=5.85\text{GHz}$	16	18		dB
Input power at 1dB compression point 1	$P_{-1\text{dB}}(1)$	$f=2.5\text{GHz}$	28	30	-	dBm
Input power at 1dB compression point 2	$P_{-1\text{dB}}(2)$	$f=5.85\text{GHz}$	25	27	-	dBm
VSWR (PC, P1, P2)	VSWR	$f=0.1\sim 5.85\text{GHz}$, ON State	-	1.4	1.6	
Switching time	T_{sw}	$f=0.1\sim 5.85\text{GHz}$	-	100	-	ns

■ TERMINAL INFORMATION

No.	SYMBOL	DESCRIPTION
1	P1	RF port. This port is connected with PC port by controlling 4 th pin ($V_{CTL(H)}$) to 2.5~6.5V and 6 th pin ($V_{CTL(L)}$) to -0.2~+0.2V. An external capacitor is required to block the DC bias voltage of internal circuit
2	GND	Ground terminal. Please connect this terminal with ground plane as close as possible for excellent RF performance.
3	P2	RF port. This port is connected with PC port by controlling 6 th pin ($V_{CTL(H)}$) to 2.5~6.5V and 4 th pin ($V_{CTL(L)}$) to -0.2~+0.2V. An external capacitor is required to block the DC bias voltage of internal circuit.
4	VCTL2	Control port 2. The voltage of this port controls PC to P1 state. The 'ON' and 'OFF' state is toggled by controlling voltage of this terminal such as high-state (2.5~6.5V) or low-state (-0.2~+0.2V). The voltage of 6 th pin have to be set to opposite state. The bypass capacitor has to be chosen to reduce switching time delay from 10pF~1000pF range.
5	PC	Common RF port. In order to block the DC bias voltage of internal circuit, an external capacitor is required.
6	VCTL1	Control port 1. The voltage of this port controls PC to P2 state. The 'ON' and 'OFF' state is toggled by controlling voltage of this terminal such as high-state (2.5~6.5V) or low-state (-0.2~+0.2V). The voltage of 4 th pin have to be set to opposite state. The bypass capacitor has to be chosen to reduce switching time delay from 10pF~1000pF range.

NJG1608KB2

■ ELECTRICAL CHARACTERISTICS

(0.1~6.0GHz, with application circuit, without DC Blocking Capacitor, Losses of external circuit are excluded.)

PC-P1 Insertion Loss vs. Frequency
(VCTL1=0V, VCTL2=3V)

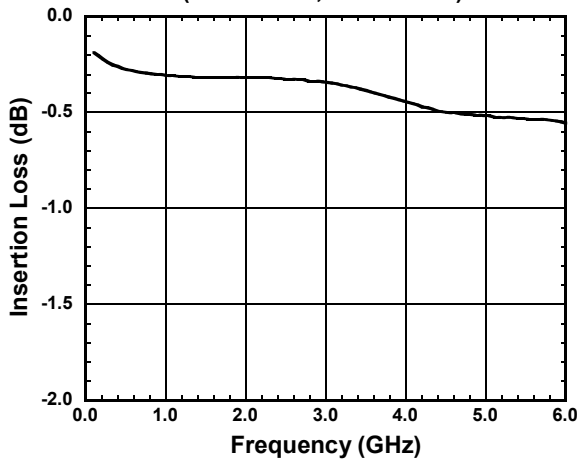

PC-P2 Insertion Loss vs. Frequency
(VCTL1=3V, VCTL2=0V)

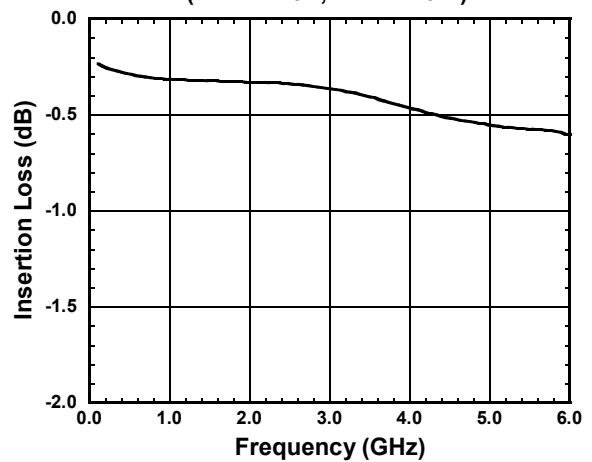

PC VSWR vs. Frequency
(PC-P1 ON, VCTL1=0V, VCTL2=3V)

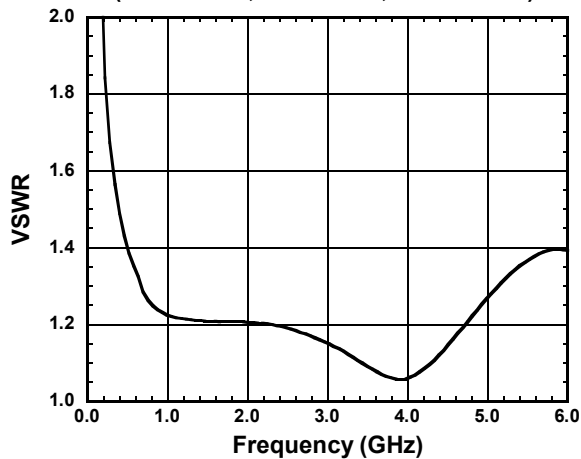

PC-P1 Isolation vs. Frequency
(VCTL1=3V, VCTL2=0V)

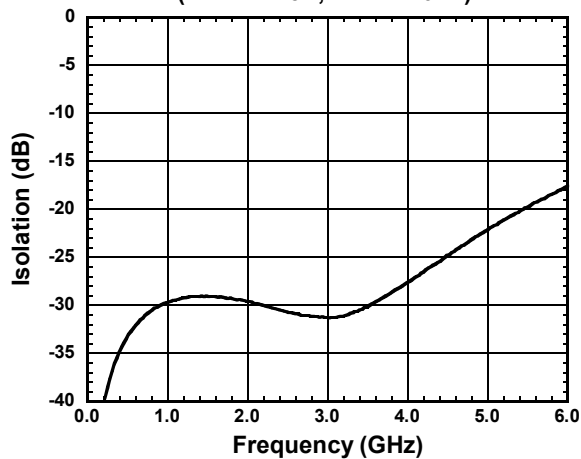

PC-P2 Isolation vs. Frequency
(VCTL1=0V, VCTL2=3V)

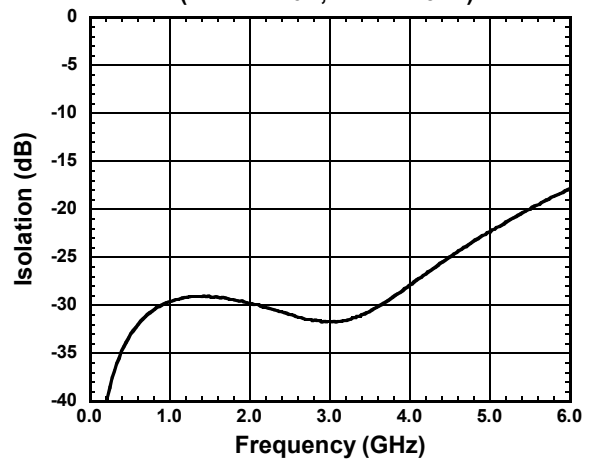

ELECTRICAL CHARACTERISTICS

PC-P1 Insertion Loss vs. Input Power

(f=2.5GHz, VCTL1=0V)

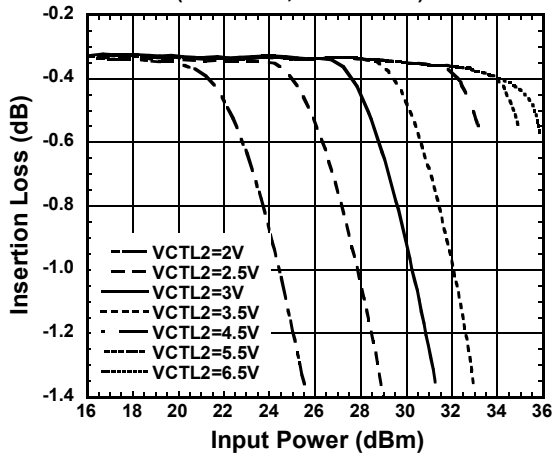

Control Current 2 vs. Input Power

(PC-P1 ON, f=2.5GHz, VCTL1=0V)

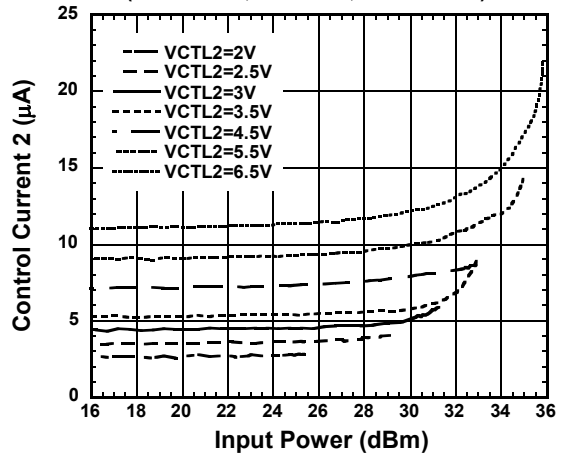

PC-P1 Insertion Loss vs. Input Power

(f=5.85GHz, VCTL1=0V)

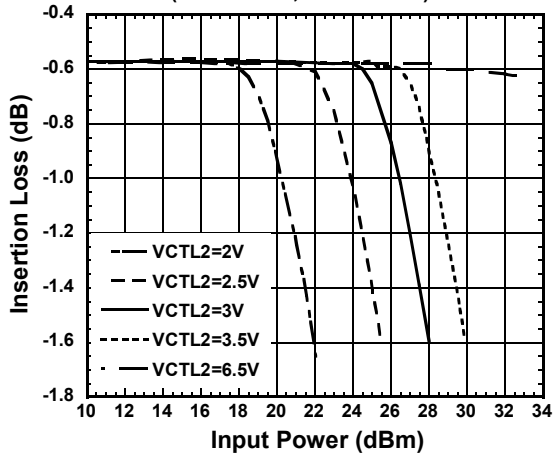

2nd Harmonics vs. Input Power

(PC-P1 ON, f=2.5GHz, VCTL1=0V)

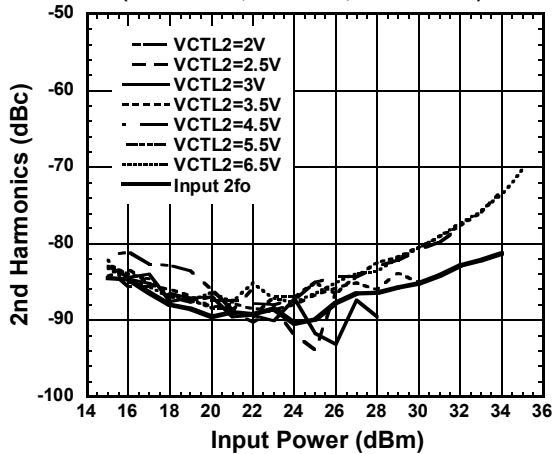

3rd Harmonics vs. Input Power

(PC-P1 ON, f=2.5GHz, VCTL1=0V)

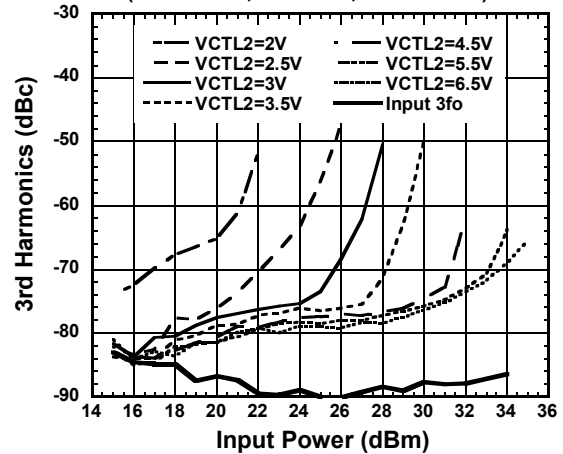

NJG1608KB2

ELECTRICAL CHARACTERISTICS

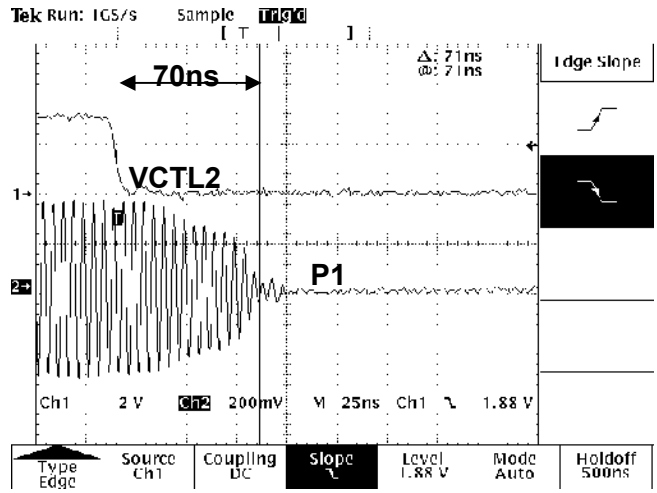
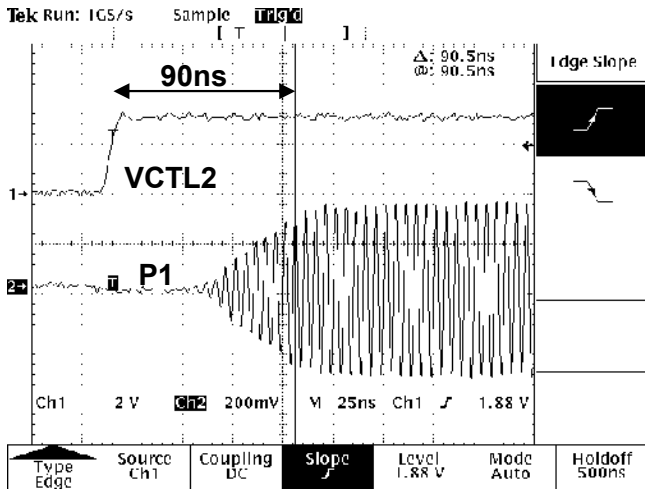

APPLICATION CIRCUIT

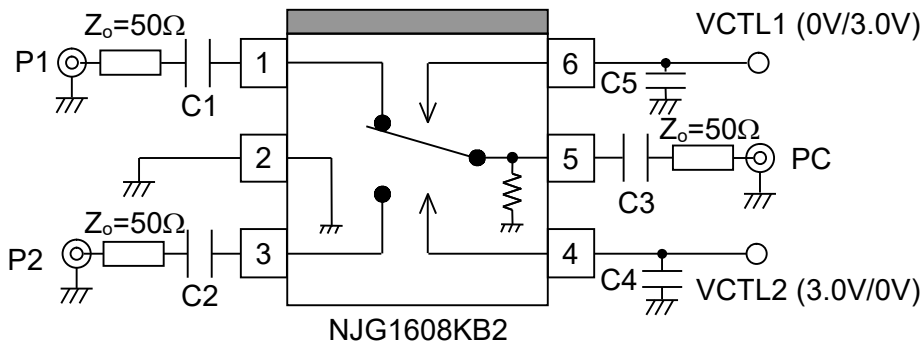

Parts List

Parts number	List 1	List 2	List 3	Notes
	100~500MHz	0.5~2.0GHz	2.0~6.0GHz	
C1~C3	1000pF	56pF	16pF	GRM15 MURATA
C4, C5	10pF	10pF	10pF	GRM15 MURATA

TEST PCB LAYOUT

(TOP VIEW)

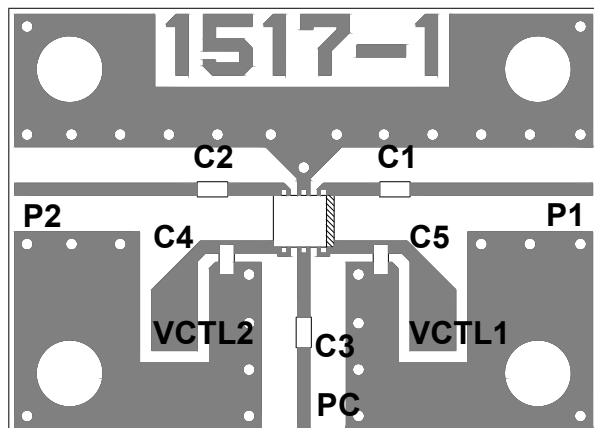

PCB SIZE=19.4x14.0mm
 PCB: FR-4, t=0.2mm
 CAPACITOR: size 1005
 STRIPLINE WIDTH=0.4mm

PRECAUTIONS

- [1] The DC blocking capacitors have to be placed at RF terminal of P1, P2 and PC. Please choose appropriate capacitance values to the application frequency.
- [2] To reduce stripline influence on RF characteristics, please locate bypass capacitors (C4, C5) close to each terminal.
- [3] For good isolation, the GND terminal (2nd pin) must be placed possibly close to ground plane of substrate, and through holes for GND should be placed near by the pin connection.

NJG1608KB2

PACKAGE OUTLINE (FLP6-B2)

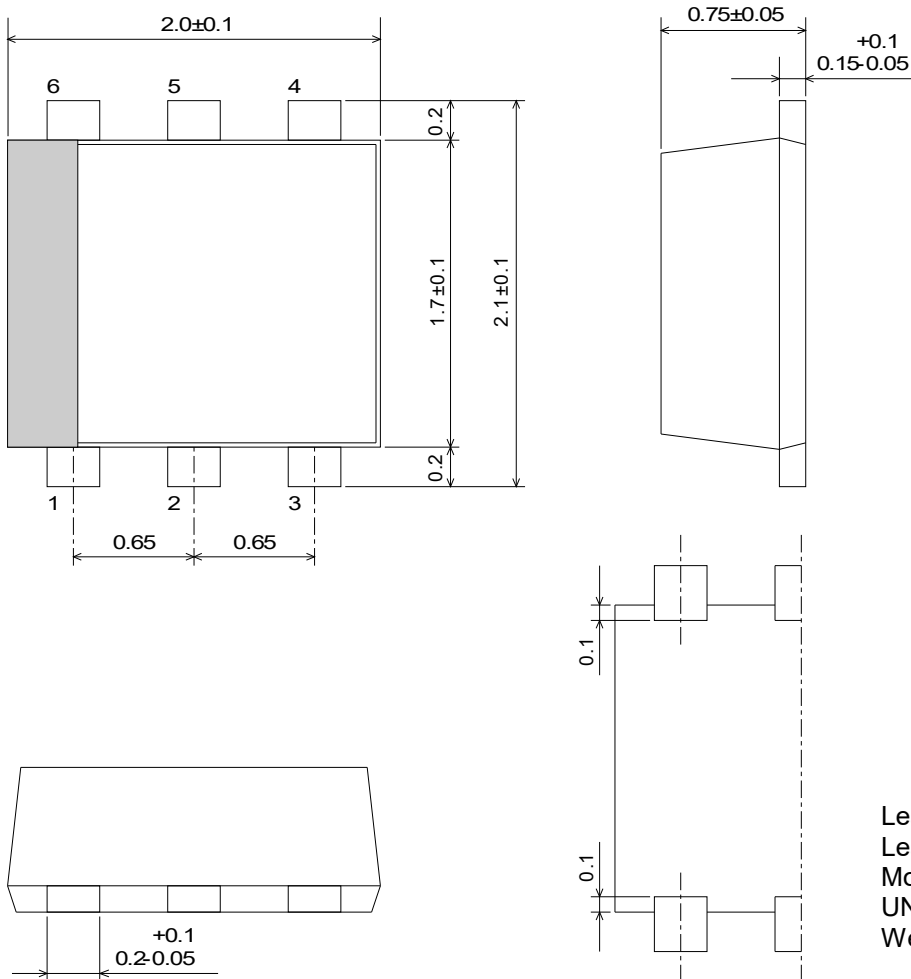

Lead material : Copper
 Lead surface finish : Solder plating
 Molding material : Epoxy resin
 UNIT : mm
 Weight : 7.0mg

Cautions on using this product

This product contains Gallium-Arsenide (GaAs) which is a harmful material.

- Do NOT eat or put into mouth.
- Do NOT dispose in fire or break up this product.
- Do NOT chemically make gas or powder with this product.
- To waste this product, please obey the relating law of your country.

[CAUTION]

The specifications on this databook are only given for information, without any guarantee as regards either mistakes or omissions. The application circuits in this databook are described only to show representative usages of the product and not intended for the guarantee or permission of any right including the industrial rights.

This product may be damaged with electric static discharge (ESD) or spike voltage. Please handle with care to avoid these damages.

1. The products and the product specifications described in this document are subject to change or discontinuation of production without notice for reasons such as improvement. Therefore, before deciding to use the products, please refer to our sales representatives for the latest information thereon.
2. The materials in this document may not be copied or otherwise reproduced in whole or in part without the prior written consent of us.
3. This product and any technical information relating thereto are subject to complementary export controls (so-called KNOW controls) under the Foreign Exchange and Foreign Trade Law, and related politics ministerial ordinance of the law. (Note that the complementary export controls are inapplicable to any application-specific products, except rockets and pilotless aircraft, that are insusceptible to design or program changes.) Accordingly, when exporting or carrying abroad this product, follow the Foreign Exchange and Foreign Trade Control Law and its related regulations with respect to the complementary export controls.
4. The technical information described in this document shows typical characteristics and example application circuits for the products. The release of such information is not to be construed as a warranty of or a grant of license under our or any third party's intellectual property rights or any other rights.
5. The products listed in this document are intended and designed for use as general electronic components in standard applications (office equipment, telecommunication equipment, measuring instruments, consumer electronic products, amusement equipment etc.). Those customers intending to use a product in an application requiring extreme quality and reliability, for example, in a highly specific application where the failure or misoperation of the product could result in human injury or death should first contact us.
 - Aerospace Equipment
 - Equipment Used in the Deep Sea
 - Power Generator Control Equipment (nuclear, steam, hydraulic, etc.)
 - Life Maintenance Medical Equipment
 - Fire Alarms / Intruder Detectors
 - Vehicle Control Equipment (automotive, airplane, railroad, ship, etc.)
 - Various Safety Devices
 - Traffic control system
 - Combustion equipment

In case your company desires to use this product for any applications other than general electronic equipment mentioned above, make sure to contact our company in advance. Note that the important requirements mentioned in this section are not applicable to cases where operation requirements such as application conditions are confirmed by our company in writing after consultation with your company.

6. We are making our continuous effort to improve the quality and reliability of our products, but semiconductor products are likely to fail with certain probability. In order to prevent any injury to persons or damages to property resulting from such failure, customers should be careful enough to incorporate safety measures in their design, such as redundancy feature, fire containment feature and fail-safe feature. We do not assume any liability or responsibility for any loss or damage arising from misuse or inappropriate use of the products.
7. The products have been designed and tested to function within controlled environmental conditions. Do not use products under conditions that deviate from methods or applications specified in this datasheet. Failure to employ the products in the proper applications can lead to deterioration, destruction or failure of the products. We shall not be responsible for any bodily injury, fires or accident, property damage or any consequential damages resulting from misuse or misapplication of the products.
8. **Quality Warranty**
 - 8-1. **Quality Warranty Period**

In the case of a product purchased through an authorized distributor or directly from us, the warranty period for this product shall be one (1) year after delivery to your company. For defective products that occurred during this period, we will take the quality warranty measures described in section 8-2. However, if there is an agreement on the warranty period in the basic transaction agreement, quality assurance agreement, delivery specifications, etc., it shall be followed.
 - 8-2. **Quality Warranty Remedies**

When it has been proved defective due to manufacturing factors as a result of defect analysis by us, we will either deliver a substitute for the defective product or refund the purchase price of the defective product.

Note that such delivery or refund is sole and exclusive remedies to your company for the defective product.
 - 8-3. **Remedies after Quality Warranty Period**

With respect to any defect of this product found after the quality warranty period, the defect will be analyzed by us. On the basis of the defect analysis results, the scope and amounts of damage shall be determined by mutual agreement of both parties. Then we will deal with upper limit in Section 8-2. This provision is not intended to limit any legal rights of your company.
9. Anti-radiation design is not implemented in the products described in this document.
10. The X-ray exposure can influence functions and characteristics of the products. Confirm the product functions and characteristics in the evaluation stage.
11. WLCSP products should be used in light shielded environments. The light exposure can influence functions and characteristics of the products under operation or storage.
12. Warning for handling Gallium and Arsenic (GaAs) products (Applying to GaAs MMIC, Photo Reflector). These products use Gallium (Ga) and Arsenic (As) which are specified as poisonous chemicals by law. For the prevention of a hazard, do not burn, destroy, or process chemically to make them as gas or power. When the product is disposed of, please follow the related regulation and do not mix this with general industrial waste or household waste.
13. Please contact our sales representatives should you have any questions or comments concerning the products or the technical information.



Nisshinbo Micro Devices Inc.

Official website

<https://www.nisshinbo-microdevices.co.jp/en/>

Purchase information

<https://www.nisshinbo-microdevices.co.jp/en/buy/>