

## 150 mA $\mu$ Cap LDO with Error Flag

### Features

- Input Voltage Range: 2.7V to 6.0V
- Thin SOT-23 Package: 1 mm Height
- Error Flag Indicates Fault Condition
- Stable with Ceramic Output Capacitor
- Ultra-low Dropout: 135 mV @ 150 mA
- High Output Accuracy:
  - 1.0% Initial Accuracy
  - 2.0% Over Temperature
- Low Quiescent Current: 90  $\mu$ A
- Tight Load and Line Regulation
- Thermal Shutdown and Current Limit Protection
- "Zero" Off-Mode Current
- TTL Logic-Controlled Enable Input

### Applications

- Cellular Phones and Pagers
- Cellular Accessories
- Battery-Powered Equipment
- Laptop, Notebook, and Palmtop Computers
- Consumer/Personal Electronics

### General Description

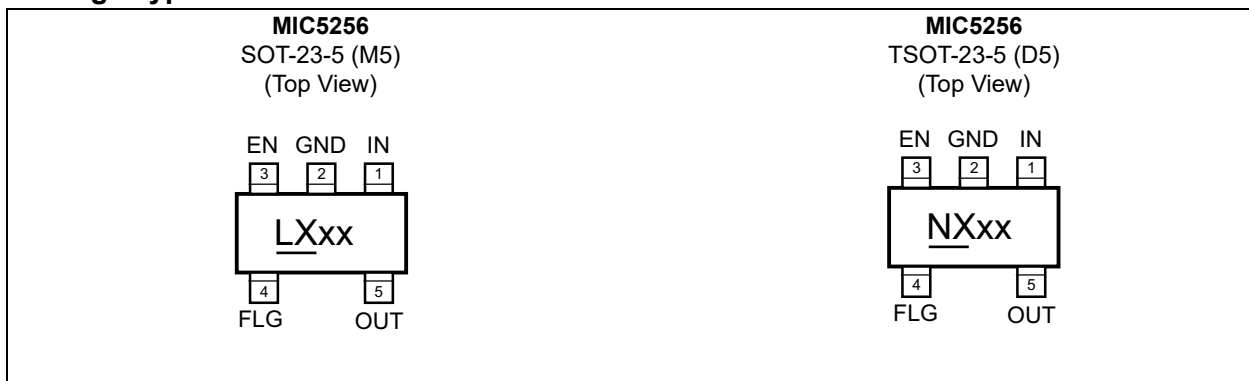
The MIC5256 is an efficient, precise CMOS voltage regulator. It offers better than 1% initial accuracy, extremely low dropout voltage (typically 135 mV at 150 mA), and low ground current (typically 90  $\mu$ A) over load. The MIC5256 features an error flag that indicates an output fault condition such as overcurrent, thermal shutdown and dropout.

Designed specifically for handheld and battery-powered devices, the MIC5256 provides a TTL-logic-compatible enable pin. When disabled, power consumption drops nearly to zero.

The MIC5256 also works with low-ESR ceramic capacitors, reducing the amount of board space necessary for power applications, critical in handheld wireless devices.

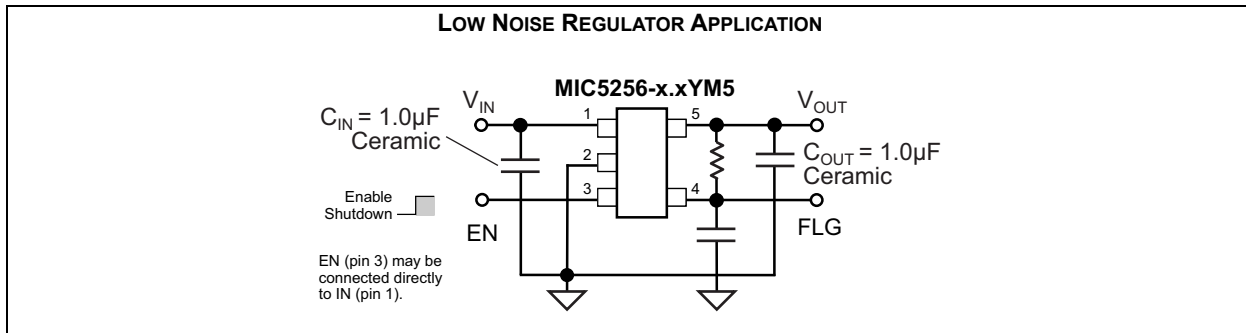
Key features include current limit, thermal shutdown, faster transient response, and an active clamp to speed up device turnoff. Available in the IttyBitty SOT-23-5 package and the Thin SOT-23-5, which offers the same footprint as the standard IttyBitty SOT-23-5, but is only 1 mm tall. The MIC5256 offers a range of output voltages.

### Package Types

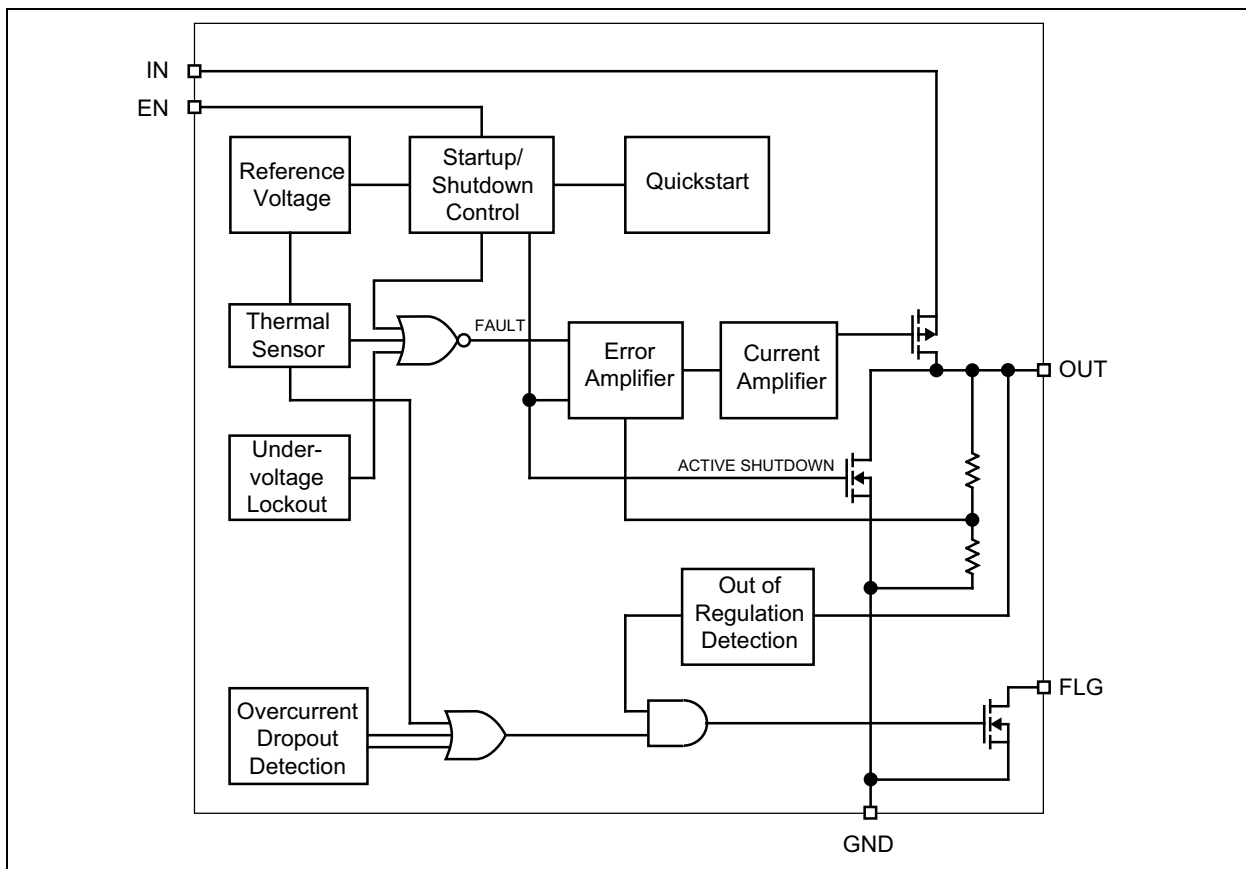


# MIC5256

## Typical Application Circuit



## Functional Block Diagram



## 1.0 ELECTRICAL CHARACTERISTICS

### Absolute Maximum Ratings †

Supply Voltage ( $V_{IN}$ )	0V to +7V
Enable Voltage ( $V_{EN}$ )	0V to +7V
Power Dissipation (Note 1)	Internally Limited
Lead Temperature (Soldering, 5 sec.)	+260°C
Storage Temperature ( $T_S$ )	-60°C to +150°C
Junction Temperature ( $T_J$ )	-40°C to +125°C
ESD Rating (Note 2)	2 kV

### Operating Ratings ††

Supply Voltage ( $V_{IN}$ )	+2.7V to +6V
Enable Voltage ( $V_{EN}$ )	0V to $V_{IN}$
Junction Temperature ( $T_J$ )	-40°C to +125°C

† **Notice:** Stresses above those listed under “Absolute Maximum Ratings” may cause permanent damage to the device. This is a stress rating only and functional operation of the device at those or any other conditions above those indicated in the operational sections of this specification is not intended. Exposure to maximum rating conditions for extended periods may affect device reliability.

†† **Notice:** The device is not guaranteed to function outside its operating ratings.

**Note 1:** The maximum allowable power dissipation of any  $T_A$  (ambient temperature) is  $P_{D(MAX)} = (T_{J(MAX)} - T_A)/\theta_{JA}$ . Exceeding the maximum allowable power dissipation will result in excessive die temperature, and the regulator will go into thermal shutdown. The  $\theta_{JA}$  of the MIC5255-x.xYM5 (all versions) is 235°C/W on a PC board (see “Thermal Considerations” section for further details).

**2:** Devices are ESD sensitive. Handling precautions are recommended. Human body model, 1.5 kΩ in series with 100 pF.

## ELECTRICAL CHARACTERISTICS

**Electrical Characteristics:**  $V_{IN} = V_{OUT} + 1V$ ,  $V_{EN} = V_{IN}$ ;  $I_{OUT} = 100 \mu A$ ;  $T_J = +25^\circ C$ , **bold** values indicate  $-40^\circ C \leq T_J \leq +125^\circ C$ ; unless noted. [Note 1](#)

Parameter	Sym.	Min.	Typ.	Max.	Units	Conditions
Output Voltage	$V_{OUT}$	-1	—	1	%	$I_{OUT} = 100 \mu A$
		<b>-2</b>	—	<b>2</b>		
Line Regulation	$\Delta V_{LNR}$	—	0.02	0.05	%/V	$V_{IN} = V_{OUT} + 1V$ to 6V
Load Regulation	$\Delta V_{LDR}$	—	1.5	2.5	%	$I_{OUT} = 0.1$ mA to 150 mA ( <a href="#">Note 2</a> )
Dropout Voltage ( <a href="#">Note 3</a> )	$V_{IN} - V_{OUT}$	—	0.1	5	mV	$I_{OUT} = 100 \mu A$
		—	90	150		$I_{OUT} = 100$ mA
		—	135	200		$I_{OUT} = 150$ mA
		—	—	<b>250</b>		
Quiescent Current	$I_Q$	—	0.2	<b>1</b>	$\mu A$	$V_{EN} \leq 0.4V$ (shutdown)

**Note 1:** Specification for packaged product only.

**2:** Regulation is measured at constant junction temperature using low duty cycle pulse testing. Parts are tested for load regulation in the load range from 0.1 mA to 150 mA. Changes in output voltage due to heating effects are covered by the thermal regulation specification.

**3:** Dropout voltage is defined as the input to output differential at which the output voltage drops 2% below its nominal value measured at 1V differential. For outputs below 2.7V, dropout voltage is the input-to-output voltage differential with the minimum input voltage 2.7V. Minimum input operating voltage is 2.7V.

**4:** Ground pin current is the regulator quiescent current. The total current drawn from the supply is the sum of the load current plus the ground pin current.

# MIC5256

## ELECTRICAL CHARACTERISTICS (CONTINUED)

**Electrical Characteristics:**  $V_{IN} = V_{OUT} + 1V$ ,  $V_{EN} = V_{IN}$ ;  $I_{OUT} = 100 \mu A$ ;  $T_J = +25^\circ C$ , **bold** values indicate  $-40^\circ C \leq T_J \leq +125^\circ C$ ; unless noted. [Note 1](#)

Parameter	Sym.	Min.	Typ.	Max.	Units	Conditions
Ground Pin Current ( <a href="#">Note 4</a> )	$I_{GND}$	—	90	150	$\mu A$	$I_{OUT} = 0 \text{ mA}$
		—	117	—		$I_{OUT} = 150 \text{ mA}$
Ripple Rejection	PSRR	—	60	—	dB	$f = 10 \text{ Hz}$ , $V_{IN} = V_{OUT} + 1V$ ; $C_{OUT} = 1.0 \mu F$
		—	60	—		$f = 100 \text{ Hz}$ , $V_{IN} = V_{OUT} + 0.5V$ ; $C_{OUT} = 1.0 \mu F$
		—	45	—		$f = 10 \text{ kHz}$ , $V_{IN} = V_{OUT} + 0.5V$
Current Limit	$I_{LIM}$	160	425	—	$\text{mA}$	$V_{OUT} = 0V$
Output Voltage Noise	$e_n$	—	509	—	$\mu V_{RMS}$	$f = 10 \text{ Hz to } 100 \text{ kHz}$ , $V_{IN} = 4.3V$ , $V_{OUT} = 3.3V$ , $I_L = 50 \text{ mA}$ , $C_{IN} = C_{OUT} = 1 \mu F \times 7R$
<b>Enable Input</b>						
Enable Input Logic Low Voltage	$V_{IL}$	—	—	<b>0.4</b>	$V$	$V_{IN} = 2.7V \text{ to } 5.5V$ , regulator shutdown
Enable Input Logic High Voltage	$V_{IH}$	<b>1.6</b>	—	—	$V$	$V_{IN} = 2.7V \text{ to } 5.5V$ , regulator enabled
Enable Input Current	$I_{EN}$	—	0.01	—	$\mu A$	$V_{IL} \leq 0.4V$ , regulator shutdown
		—	0.01	—		$V_{IH} \geq 1.6V$ , regulator enabled
Shutdown Resistance Discharge	$R_{DCHG}$	—	500	—	$\Omega$	—
<b>Error Flag</b>						
Low Threshold	$V_{FLG}$	90	—	—	$\%$	% of $V_{OUT}$ (Flag ON)
High Threshold		—	—	96		% of $V_{OUT}$ (Flag OFF)
Output Logic Low Voltage	$V_{OL}$	—	0.02	<b>0.1</b>	$V$	$I_L = 100 \mu A$ , fault condition
Flag Leakage Current	$I_{FLG}$	—	0.01	—	$\mu A$	Flag off, $V_{FLG} = 6V$
<b>Thermal Protection</b>						
Thermal Shutdown Temperature	$T_{SD}$	—	150	—	$^\circ C$	—
Thermal Shutdown Hysteresis	$\Delta T_{SD}$	—	10	—	$^\circ C$	—

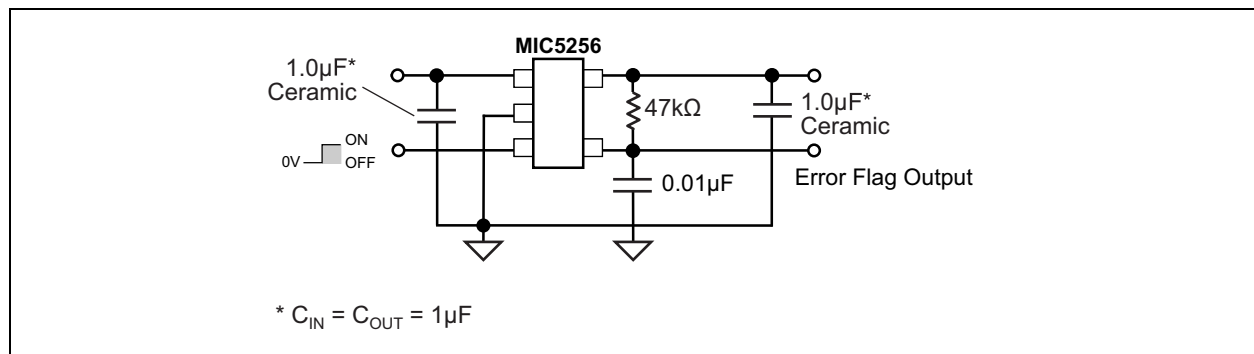
**Note 1:** Specification for packaged product only.

- 2:** Regulation is measured at constant junction temperature using low duty cycle pulse testing. Parts are tested for load regulation in the load range from 0.1 mA to 150 mA. Changes in output voltage due to heating effects are covered by the thermal regulation specification.
- 3:** Dropout voltage is defined as the input to output differential at which the output voltage drops 2% below its nominal value measured at 1V differential. For outputs below 2.7V, dropout voltage is the input-to-output voltage differential with the minimum input voltage 2.7V. Minimum input operating voltage is 2.7V.
- 4:** Ground pin current is the regulator quiescent current. The total current drawn from the supply is the sum of the load current plus the ground pin current.

## TEMPERATURE SPECIFICATIONS

Parameters	Sym.	Min.	Typ.	Max.	Units	Conditions
<b>Temperature Ranges</b>						
Maximum Junction Temperature Range	$T_J$	-40	—	+125	°C	—
Storage Temperature Range	$T_S$	-60	—	+150	°C	—
Lead Temperature	—	—	—	+260	°C	Soldering, 5 sec.
<b>Package Thermal Resistances</b>						
Thermal Resistance, SOT-23-5	$\theta_{JA}$	—	235	—	°C/W	—
	$\theta_{JC}$	—	145	—	°C/W	—

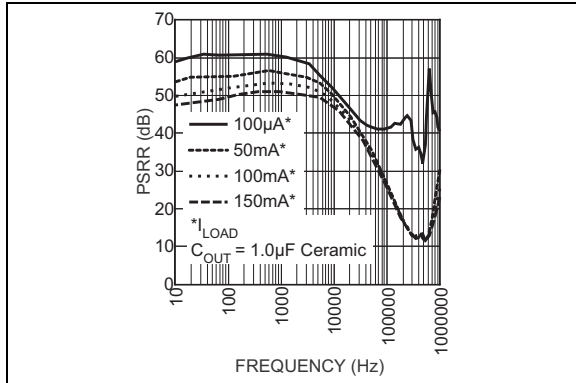
**Note 1:** The maximum allowable power dissipation is a function of ambient temperature, the maximum allowable junction temperature and the thermal resistance from junction to air (i.e.,  $T_A$ ,  $T_J$ ,  $\theta_{JA}$ ). Exceeding the maximum allowable power dissipation will cause the device operating junction temperature to exceed the maximum +125°C rating. Sustained junction temperatures above +125°C can impact the device reliability.



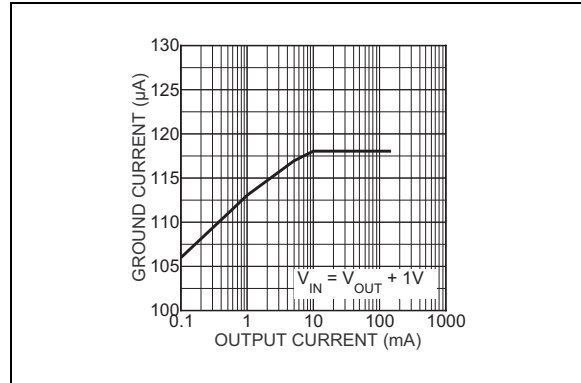
**FIGURE 1-1:** Test Circuit.

## 2.0 TYPICAL PERFORMANCE CURVES

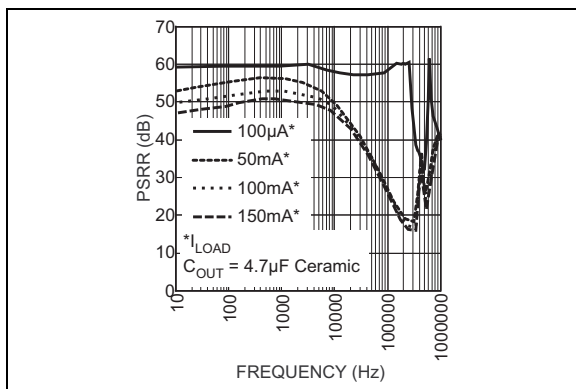
**Note:** The graphs and tables provided following this note are a statistical summary based on a limited number of samples and are provided for informational purposes only. The performance characteristics listed herein are not tested or guaranteed. In some graphs or tables, the data presented may be outside the specified operating range (e.g., outside specified power supply range) and therefore outside the warranted range.



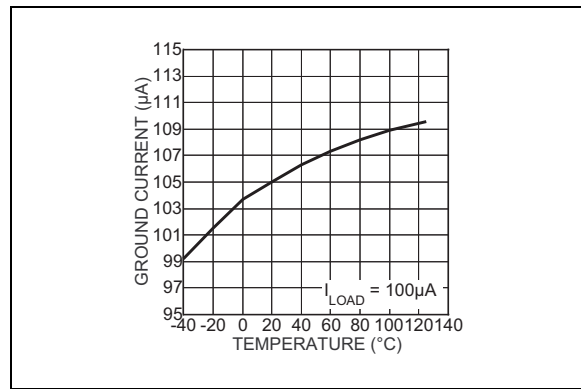
**FIGURE 2-1:** Power Supply Rejection Ratio.



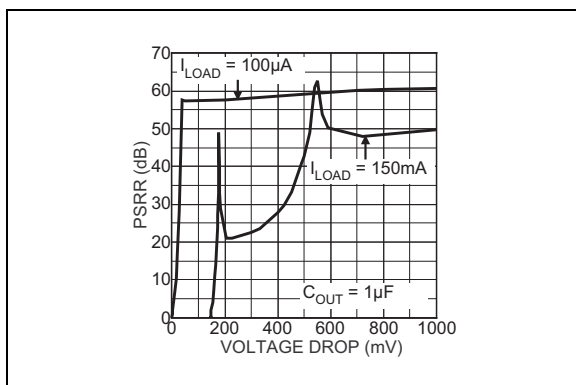
**FIGURE 2-4:** Ground Pin Current.



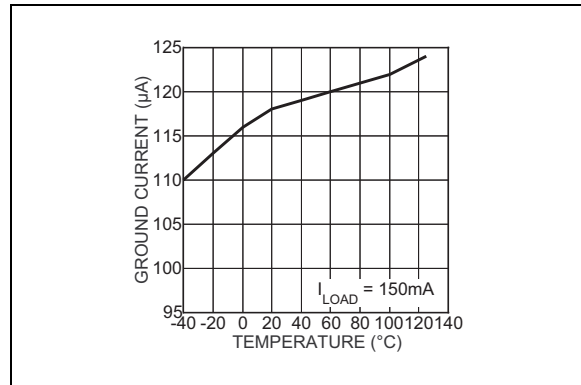
**FIGURE 2-2:** Power Supply Rejection Ratio.



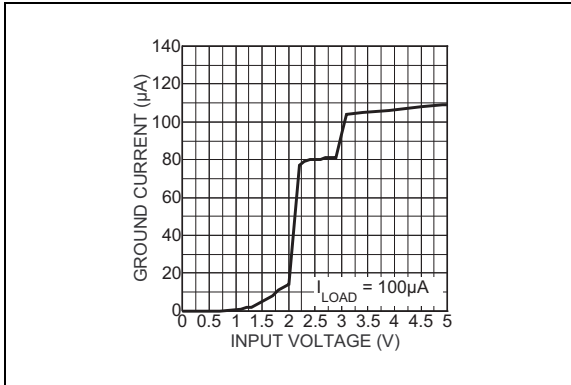
**FIGURE 2-5:** Ground Pin Current.



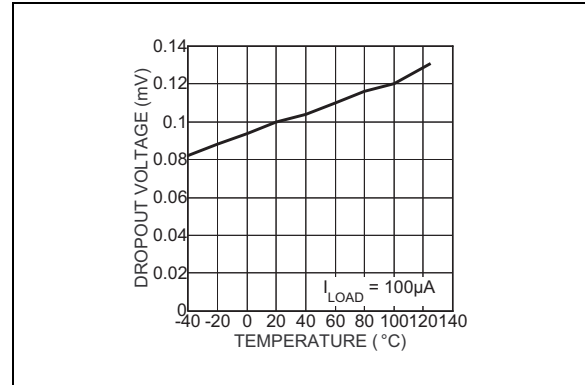
**FIGURE 2-3:** Power Supply Rejection Ratio vs. Voltage Drop.



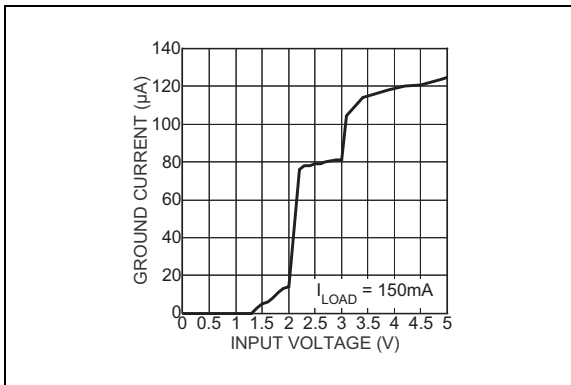
**FIGURE 2-6:** Ground Pin Current.



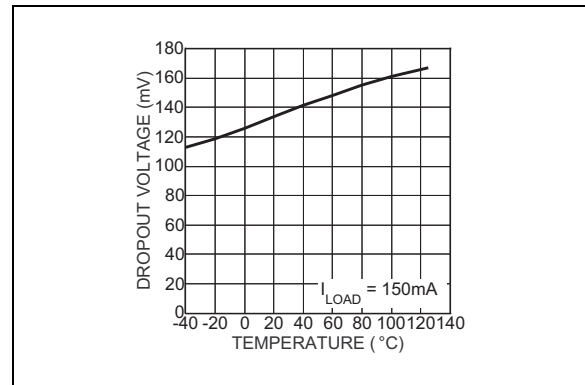
**FIGURE 2-7:** Ground Pin Current.



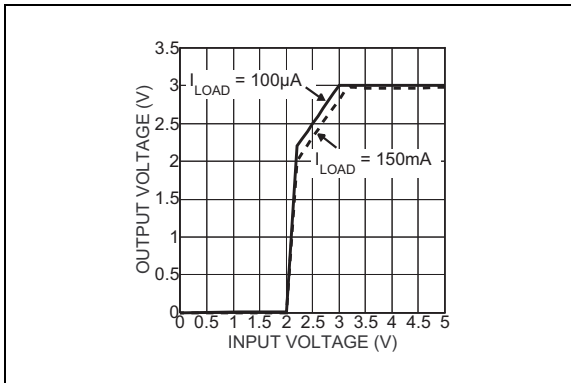
**FIGURE 2-10:** Dropout Voltage.



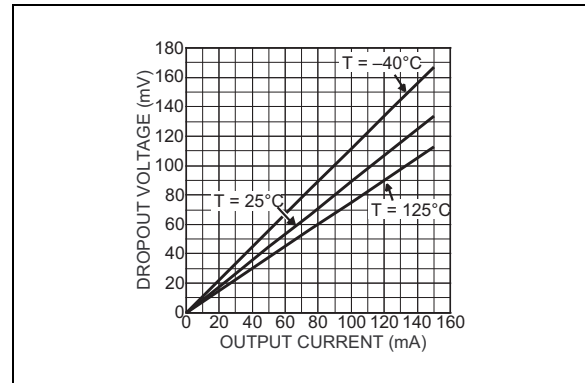
**FIGURE 2-8:** Ground Pin Current.



**FIGURE 2-11:** Dropout Voltage.

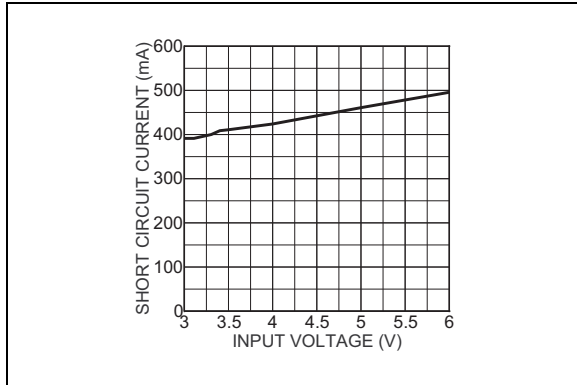


**FIGURE 2-9:** Dropout Characteristics.

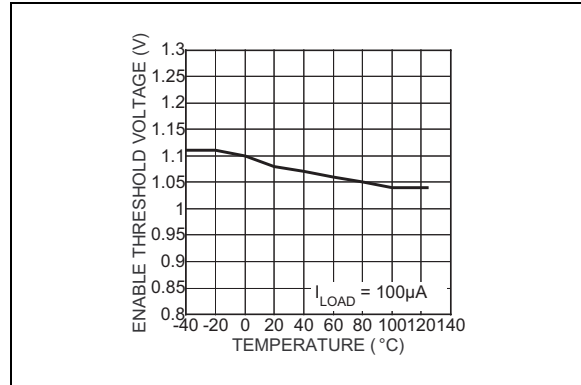


**FIGURE 2-12:** Dropout Voltage.

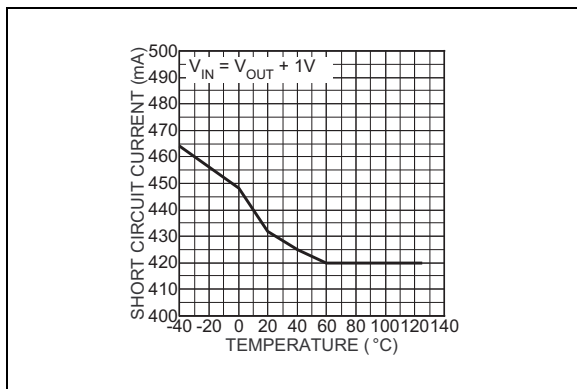
# MIC5256



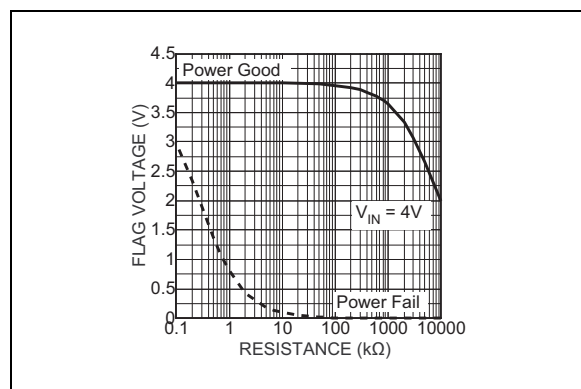
**FIGURE 2-13:** Short-Circuit Current.



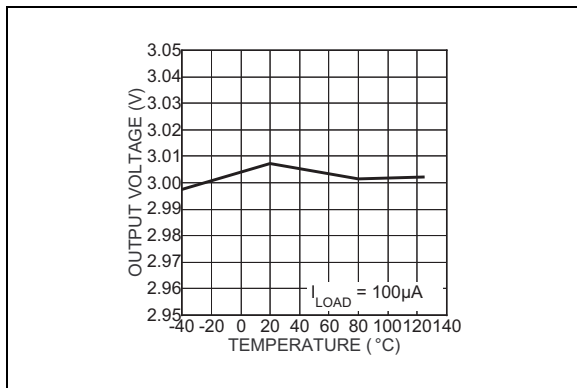
**FIGURE 2-16:** Enable Threshold vs. Temperature.



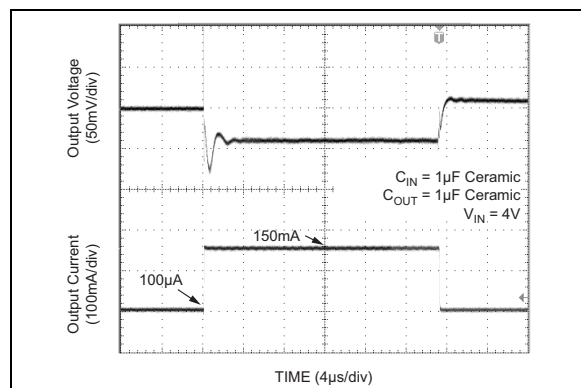
**FIGURE 2-14:** Short-Circuit Current.



**FIGURE 2-17:** Error Flag Pull-Up Resistor.

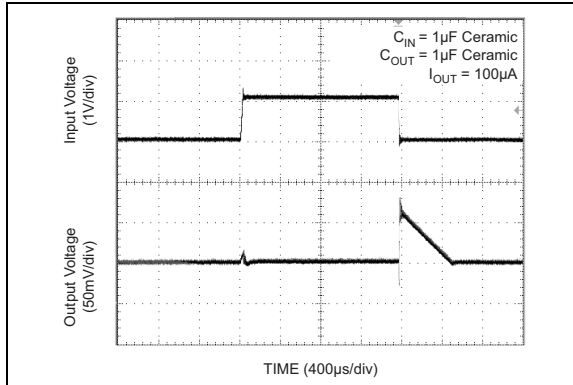


**FIGURE 2-15:** Output Voltage vs. Temperature.

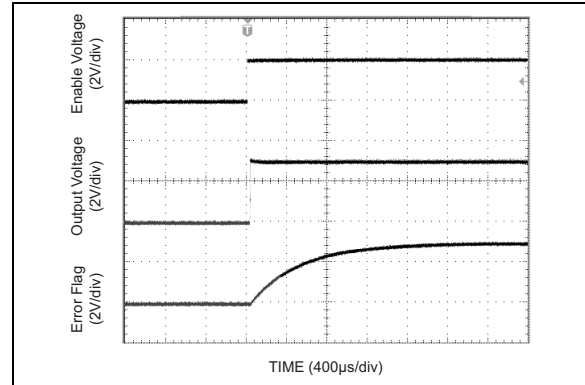


**FIGURE 2-18:** Load Transient Response.

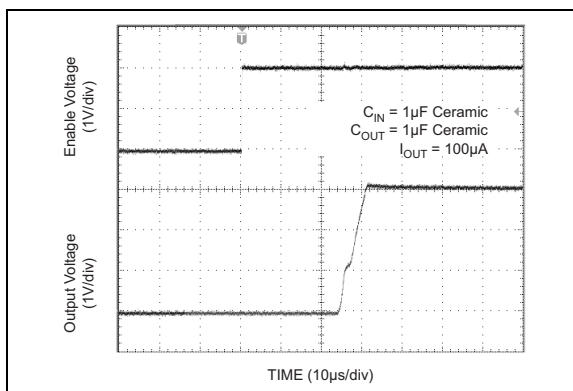




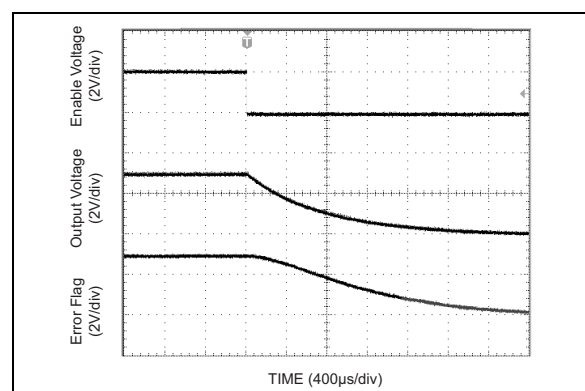
**FIGURE 2-19:** Line Transient Response.



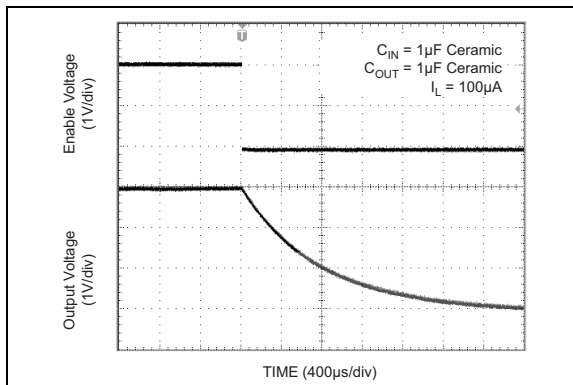
**FIGURE 2-22:** Error Flag Start-Up (see [Figure 1-1](#)).



**FIGURE 2-20:** Enable Pin Delay.



**FIGURE 2-23:** Error Flag Shutdown (see [Figure 1-1](#)).



**FIGURE 2-21:** Shutdown Delay.

# MIC5256

---

## 3.0 PIN DESCRIPTIONS

The descriptions of the pins are listed in [Table 3-1](#).

**TABLE 3-1: PIN FUNCTION TABLE**

Pin Number	Pin Name	Description
1	IN	Supply Input.
2	GND	Ground.
3	EN	Enable/Shutdown (Input): TTL-compatible input. Logic-high = enable; logic-low = shutdown. Do not leave open.
4	FLG	Error Flag (Output): Open-drain output. Active low indicates an output undervoltage condition.
5	OUT	Regulator Output.

## 4.0 APPLICATION INFORMATION

### 4.1 Enable/Shutdown

The MIC5256 comes with an active-high enable pin that allows the regulator to be disabled. Forcing the enable pin low disables the regulator and sends it into a “zero” off-mode-current state. In this state, current consumed by the regulator goes nearly to zero. Forcing the enable pin high enables the output voltage. This part is CMOS and the enable pin cannot be left floating; a floating enable pin may cause an indeterminate state on the output.

### 4.2 Input Capacitor

The MIC5256 is a high-performance, high-bandwidth device. Therefore, it requires a well-bypassed input supply for optimal performance. A 1  $\mu\text{F}$  capacitor is required from the input to ground to provide stability. Low-ESR ceramic capacitors provide optimal performance at a minimum of space. Additional high-frequency capacitors, such as small valued NPO dielectric type capacitors, help filter out high frequency noise and are good practice in any RF-based circuit.

### 4.3 Output Capacitor

The MIC5256 requires an output capacitor for stability. The design requires 1  $\mu\text{F}$  or greater on the output to maintain stability. The design is optimized for use with low-ESR ceramic-chip capacitors. High-ESR capacitors may cause high-frequency oscillation. The maximum recommended ESR is 300 m $\Omega$ . The output capacitor can be increased, but performance has been optimized for a 1  $\mu\text{F}$  ceramic output capacitor and does not improve significantly with larger capacitance.

X7R/X5R dielectric-type ceramic capacitors are recommended because of their temperature performance. X7R-type capacitors change capacitance by 15% over their operating temperature range and are the most stable type of ceramic capacitors. Z5U and Y5V dielectric capacitors change value by as much as 50% and 60% respectively over their operating temperature ranges. To use a ceramic chip capacitor with Y5V dielectric, the value must be much higher than an X7R ceramic capacitor to ensure the same minimum capacitance over the equivalent operating temperature range.

### 4.4 Error Flag

The error flag output is an active-low, open-drain output that drives low when a fault condition AND an undervoltage detection occurs. Internal circuitry intelligently monitors overcurrent, overtemperature and dropout conditions and ORs these outputs together to indicate some fault condition. The output of that OR gate is ANDed with an output voltage monitor that detects an undervoltage condition. That output drives

the open-drain transistor to indicate a fault. This prevents chattering or inadvertent triggering of the error flag. The error flag must be pulled up using a resistor from the flag pin to either the input or the output.

The error flag circuit was designed essentially to work with a capacitor to ground to act as a power-on reset generator, signaling a power good situation once the regulated voltage was up and/or out of a fault condition. This capacitor delays the error signal from pulling high, allowing the down stream circuits time to stabilize. When the error flag is pulled up to the input without using a pull-down capacitor, then there can be a glitch on the error flag upon start up of the device. This is due to the response time of the error flag circuit as the device starts up. When the device comes out of the “zero” off-mode-current state, all the various nodes of the circuit power up before the device begins supplying full current to the output capacitor. The error flag drives low immediately and then releases after a few microseconds. The intelligent circuit that triggers an error detects the output going into current limit and the output being low while charging the output capacitor. The error output then pulls low for the duration of the turn-on time. A capacitor from the error flag to ground will filter out this glitch. The glitch does not occur if the error flag pulled up to the output.

### 4.5 Active Shutdown

The MIC5256 also features an active shutdown clamp, which is an N-channel MOSFET that turns on when the device is disabled. This allows the output capacitor and load to discharge, de-energizing the load.

### 4.6 No-Load Stability

The MIC5256 will remain stable and in regulation with no load, unlike many other voltage regulators. This is especially important in CMOS RAM keep-alive applications.

### 4.7 Thermal Considerations

The MIC5256 is designed to provide 150 mA of continuous current in a very small package. Maximum power dissipation can be calculated based on the output current and the voltage drop across the part. To determine the maximum power dissipation of the package, use the junction-to-ambient thermal resistance of the device and the following basic equation:

#### EQUATION 4-1:

$$P_{D(MAX)} = \frac{T_{J(MAX)} - T_A}{\theta_{JA}}$$

# MIC5256

In [Equation 4-1](#),  $\theta_{JA}$  is layout-dependent. [Table 4-1](#) shows examples of junction-to-ambient thermal resistance for the MIC5256.

**TABLE 4-1: SOT-23-5 THERMAL RESISTANCE**

$\theta_{JA}$ Rec. Min. Footprint	$\theta_{JA}$ 1" Square Copper Clad	$\theta_{JC}$
235°C/W	185°C/W	145°C/W

The actual power dissipation of the regulator circuit can be determined using the following equation:

**EQUATION 4-2:**

$$P_D = (V_{IN} - V_{OUT}) \times I_{OUT} + V_{IN} \times I_{GND}$$

Substituting  $P_{D(MAX)}$  for  $P_D$  and solving for the operating conditions that are critical to the application will give the maximum operating conditions for the regulator circuit. For example, when operating the MIC5256-3.0YM5 at 50°C with a minimum footprint layout, the maximum input voltage for a set output current can be determined as follows:

**EQUATION 4-3:**

$$P_{D(MAX)} = \frac{125^\circ C - 50^\circ C}{235^\circ C/W} = 319mW$$

The junction-to-ambient thermal resistance for the minimum footprint is 235°C/W, from [Table 4-1](#). The maximum power dissipation must not be exceeded for proper operation. Using the output voltage of 3.0V and an output current of 150 mA, the maximum input voltage can be determined. Because this device is CMOS and the ground current is typically 100  $\mu$ A over the load range, the power dissipation contributed by the ground current is <1% and can be ignored for this calculation.

**EQUATION 4-4:**

$$319mW = (V_{IN} - 3.0V) \times 150mA$$

$$319mW = V_{IN} \times 150mA - 450mW$$

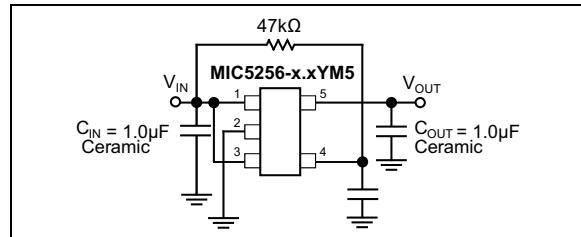
$$769mW = V_{IN} \times 150mA$$

$$V_{IN(MAX)} = 5.1V$$

Therefore, a 3.0V application at 150 mA of output current can accept a maximum input voltage of 5.1V in a SOT-23-5 package. For a full discussion of heat sinking and thermal effects on voltage regulators, refer to the “Regulator Thermals” section of Microchip’s [Designing with Low-Dropout Voltage Regulators](#) handbook.

## 4.8 Fixed Regulator Applications

[Figure 4-1](#) shows a standard low-noise configuration with a 47 k $\Omega$  pull-up resistor from the error flag to the input voltage and a pull-down capacitor to ground for the purpose of fault indication. EN (Pin 3) is connected to IN (Pin 1) for an application where enable/shutdown is not required.  $C_{OUT} = 1.0 \mu$ F minimum.



**FIGURE 4-1: Low-Noise Fixed Voltage Application.**

## 5.0 PACKAGING INFORMATION

### 5.1 Package Marking Information

SOT-23-5\*

XXXX

Example

LX26

TSOT-23-5\*

XXXX

Example

NX2J

**TABLE 5-1: PART MARKING**

Part Number	Part Marking
MIC5256-1.5YM5	<u>LX15</u>
MIC5256-1.8YM5	<u>LX18</u>
MIC5256-2.5YM5	<u>LX25</u>
MIC5256-2.6YM5	<u>LX26</u>
MIC5256-2.7YM5	<u>LX27</u>
MIC5256-2.8YM5	<u>LX28</u>
MIC5256-2.85YM5	<u>LX2J</u>
MIC5256-2.9YM5	<u>LX29</u>
MIC5256-3.0YM5	<u>LX30</u>
MIC5256-3.1YM5	<u>LX31</u>
MIC5256-3.3YM5	<u>LX33</u>
MIC5256-2.85YD5	<u>NX2J</u>

<p><b>Legend:</b> XX...X Product code or customer-specific information          Y Year code (last digit of calendar year)          YY Year code (last 2 digits of calendar year)          WW Week code (week of January 1 is week '01')          NNN Alphanumeric traceability code          (e3) Pb-free JEDEC® designator for Matte Tin (Sn)          * This package is Pb-free. The Pb-free JEDEC designator (e3) can be found on the outer packaging for this package.</p> <p>•, ▲, ▼ Pin one index is identified by a dot, delta up, or delta down (triangle mark).</p>
<p><b>Note:</b> In the event the full Microchip part number cannot be marked on one line, it will be carried over to the next line, thus limiting the number of available characters for customer-specific information. Package may or may not include the corporate logo.</p> <p>Underbar ( <u> </u> ) and/or Overbar ( <math>\bar{\quad}</math> ) symbol may not be to scale.</p>

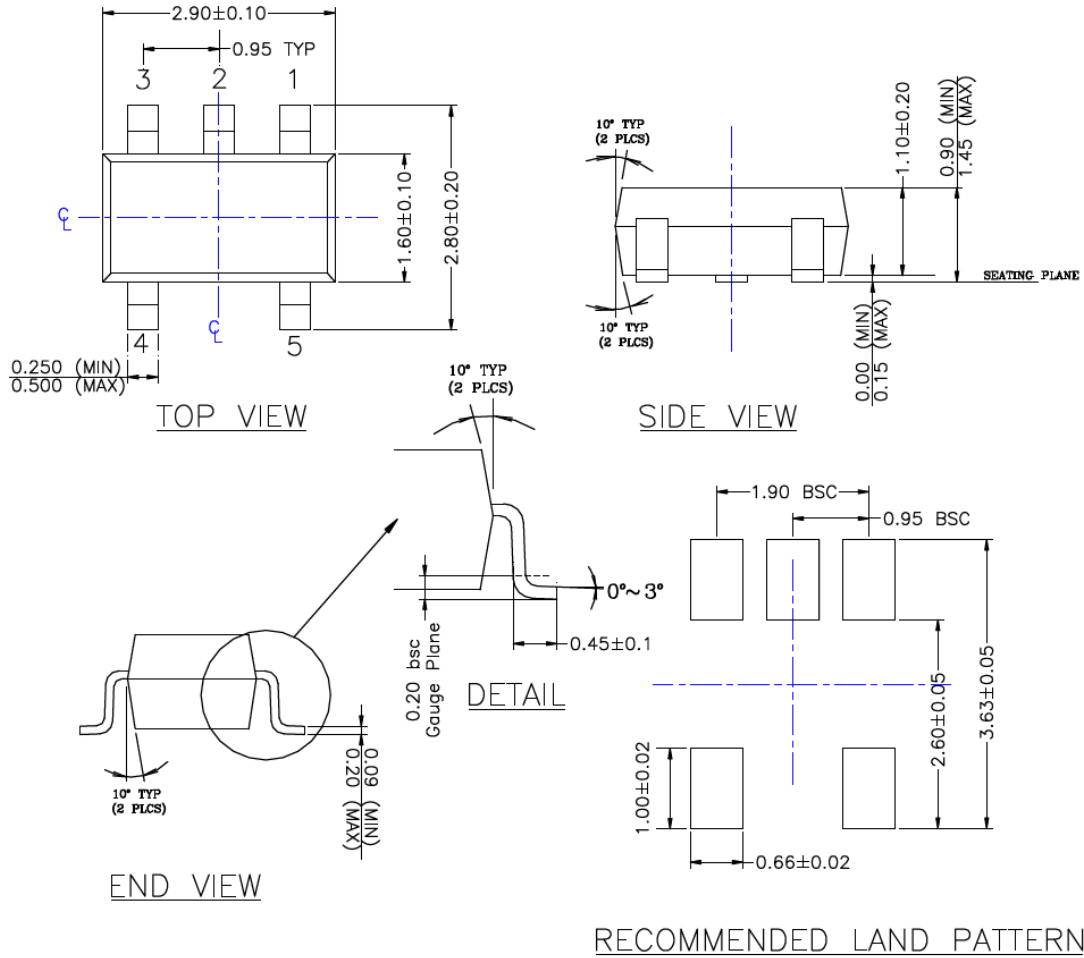
# MIC5256

## 5-Lead SOT-23 Package Outline & Recommended Land Pattern

**TITLE**

5 LEAD SOT23 PACKAGE OUTLINE & RECOMMENDED LAND PATTERN

DRAWING #	SOT23-5LD-PL-1	UNIT	MM
-----------	----------------	------	----



**NOTE:**

1. PACKAGE OUTLINE EXCLUSIVE OF MOLD FLASH & BURR.
2. PACKAGE OUTLINE INCLUSIVE OF SOLER PLATING.
3. DIMENSION AND TOLERANCE PER ANSI Y14.5M, 1982.
4. FOOT LENGTH MEASUREMENT BASED ON GAUGE PLANE METHOD.
5. DIE FACES UP FOR MOLD, AND FACES DOWN FOR TRIM/FORM.
6. ALL DIMENSIONS ARE IN MILLIMETERS.

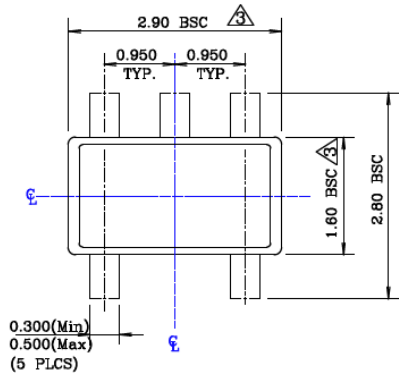
Note: For the most current package drawings, please see the Microchip Packaging Specification located at <http://www.microchip.com/packaging>.

## 5-Lead TSOT-23 Package Outline and Recommended Land Pattern

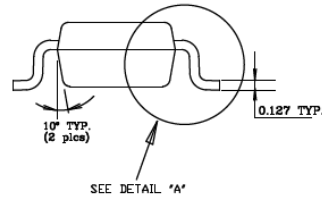
**TITLE**

5 LEAD TSOT PACKAGE OUTLINE & RECOMMENDED LAND PATTERN

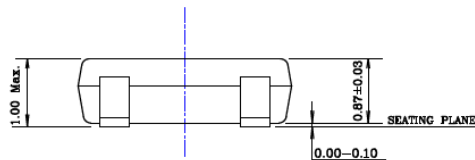
DRAWING #	TSOT-5LD-PL-1	UNIT	MM
-----------	---------------	------	----



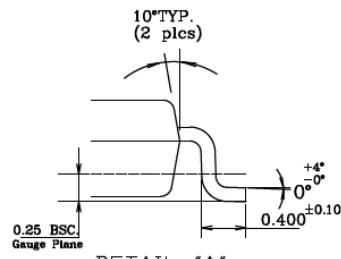
TOP VIEW  
NOTES : 3, 6



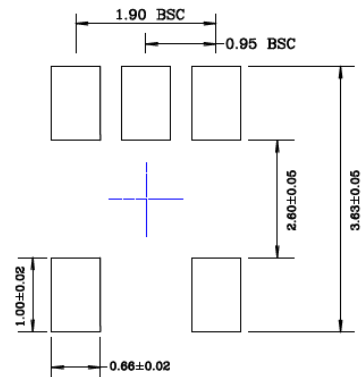
END VIEW  
NOTES : 2, 4, 6



TOP VIEW  
NOTES : 4, 6



DETAIL "A"



RECOMMENDED LAND PATTERN

**NOTE:**

1. Dimensions and tolerances are as per ANSI Y14.5M, 1994.
2. Die is facing up for mold. Die is facing down for trim/form, ie. reverse trim/form.
3. Dimensions are exclusive of mold flash and gate burr.
4. The footlength measuring is based on the gauge plane method.
5. All specification comply to Jedec Spec MO193 Issue C.
6. All dimensions are in millimeters.

Note: For the most current package drawings, please see the Microchip Packaging Specification located at <http://www.microchip.com/packaging>.

# MIC5256

---

NOTES:



## APPENDIX A: REVISION HISTORY

### Revision A (November 2020)

- Converted Micrel document MIC5256 to Microchip data sheet template DS20006446A.
- Minor grammatical text changes throughout.

# MIC5256

---

NOTES:

## PRODUCT IDENTIFICATION SYSTEM

To order or obtain information, e.g., on pricing or delivery, contact your local Microchip representative or sales office.

Device	-X.X	X	XX	-XX
Part No.	Output Voltage	Junction Temp. Range	Package	Media Type
<b>Device:</b>	MIC5256:	150 mA $\mu$ Cap LDO with Error Flag		
<b>Output Voltage:</b>	1.5 = 1.5V 1.8 = 1.8V 2.5 = 2.5V 2.6 = 2.6V 2.7 = 2.7V 2.8 = 2.8V 2.85 = 2.85V (available for both packages) 2.9 = 2.9V 3.0 = 3.0V 3.1 = 3.1V 3.3 = 3.3V			
<b>Junction Temperature Range:</b>	Y =	-40°C to +125°C, RoHS-Compliant		
<b>Package:</b>	M5 = D5 =	5-Lead SOT-23 5-Lead TSOT-23		
<b>Media Type:</b>	TR =	3,000/Reel		
<b>Examples:</b>				
a) MIC5256-2.85YD5-TR: MIC5256, 2.85V Output Voltage, -40°C to +125°C Temperature Range, 5-Lead TSOT-23, 3,000/Reel				
b) MIC5256-1.8YM5-TR: MIC5256, 1.8V Output Voltage, -40°C to +125°C Temperature Range, 5-Lead SOT-23, 3,000/Reel				
c) MIC5256-2.6YM5-TR: MIC5256, 2.6V Output Voltage, -40°C to +125°C Temperature Range, 8-Lead SOT-23, 3,000/Reel				
d) MIC5256-2.85YM5-TR: MIC5256, 2.85V Output Voltage, -40°C to +125°C Temperature Range, 5-Lead SOT-23, 3,000/Reel				
e) MIC5256-3.0YM5-TR: MIC5256, 3.0V Output Voltage, -40°C to +125°C Temperature Range, 5-Lead SOT-23, 3,000/Reel				
f) MIC5256-3.1YM5-TR: MIC5256, 3.1V Output Voltage, -40°C to +125°C Temperature Range, 5-Lead SOT-23, 3,000/Reel				
g) MIC5256-3.3YM5-TR: MIC5256, 3.3V Output Voltage, -40°C to +125°C Temperature Range, 5-Lead SOT-23, 3,000/Reel				
<b>Note 1:</b> Tape and Reel identifier only appears in the catalog part number description. This identifier is used for ordering purposes and is not printed on the device package. Check with your Microchip Sales Office for package availability with the Tape and Reel option.				

# MIC5256

---

NOTES:

---

**Note the following details of the code protection feature on Microchip devices:**

- Microchip products meet the specifications contained in their particular Microchip Data Sheet.
- Microchip believes that its family of products is secure when used in the intended manner and under normal conditions.
- There are dishonest and possibly illegal methods being used in attempts to breach the code protection features of the Microchip devices. We believe that these methods require using the Microchip products in a manner outside the operating specifications contained in Microchip's Data Sheets. Attempts to breach these code protection features, most likely, cannot be accomplished without violating Microchip's intellectual property rights.
- Microchip is willing to work with any customer who is concerned about the integrity of its code.
- Neither Microchip nor any other semiconductor manufacturer can guarantee the security of its code. Code protection does not mean that we are guaranteeing the product is "unbreakable." Code protection is constantly evolving. We at Microchip are committed to continuously improving the code protection features of our products. Attempts to break Microchip's code protection feature may be a violation of the Digital Millennium Copyright Act. If such acts allow unauthorized access to your software or other copyrighted work, you may have a right to sue for relief under that Act.

---

Information contained in this publication is provided for the sole purpose of designing with and using Microchip products. Information regarding device applications and the like is provided only for your convenience and may be superseded by updates. It is your responsibility to ensure that your application meets with your specifications.

THIS INFORMATION IS PROVIDED BY MICROCHIP "AS IS". MICROCHIP MAKES NO REPRESENTATIONS OR WARRANTIES OF ANY KIND WHETHER EXPRESS OR IMPLIED, WRITTEN OR ORAL, STATUTORY OR OTHERWISE, RELATED TO THE INFORMATION INCLUDING BUT NOT LIMITED TO ANY IMPLIED WARRANTIES OF NON-INFRINGEMENT, MERCHANTABILITY, AND FITNESS FOR A PARTICULAR PURPOSE OR WARRANTIES RELATED TO ITS CONDITION, QUALITY, OR PERFORMANCE.

IN NO EVENT WILL MICROCHIP BE LIABLE FOR ANY INDIRECT, SPECIAL, PUNITIVE, INCIDENTAL OR CONSEQUENTIAL LOSS, DAMAGE, COST OR EXPENSE OF ANY KIND WHATSOEVER RELATED TO THE INFORMATION OR ITS USE, HOWEVER CAUSED, EVEN IF MICROCHIP HAS BEEN ADVISED OF THE POSSIBILITY OR THE DAMAGES ARE FORESEEABLE. TO THE FULLEST EXTENT ALLOWED BY LAW, MICROCHIP'S TOTAL LIABILITY ON ALL CLAIMS IN ANY WAY RELATED TO THE INFORMATION OR ITS USE WILL NOT EXCEED THE AMOUNT OF FEES, IF ANY, THAT YOU HAVE PAID DIRECTLY TO MICROCHIP FOR THE INFORMATION. Use of Microchip devices in life support and/or safety applications is entirely at the buyer's risk, and the buyer agrees to defend, indemnify and hold harmless Microchip from any and all damages, claims, suits, or expenses resulting from such use. No licenses are conveyed, implicitly or otherwise, under any Microchip intellectual property rights unless otherwise stated.

**Trademarks**

The Microchip name and logo, the Microchip logo, Adaptec, AnyRate, AVR, AVR logo, AVR Freaks, BesTime, BitCloud, chipKIT, chipKIT logo, CryptoMemory, CryptoRF, dsPIC, FlashFlex, flexPWR, HELDO, IGL00, JukeBlox, KeeLoq, Kleer, LANCheck, LinkMD, maXStylus, maXTouch, MediaLB, megaAVR, Microsemi, Microsemi logo, MOST, MOST logo, MPLAB, OptoLyzer, PackeTime, PIC, picoPower, PICSTART, PIC32 logo, PolarFire, Prochip Designer, QTouch, SAM-BA, SenGenuity, SpyNIC, SST, SST Logo, SuperFlash, Symmetricom, SyncServer, Tachyon, TimeSource, tinyAVR, UNI/O, Vectron, and XMEGA are registered trademarks of Microchip Technology Incorporated in the U.S.A. and other countries.

AgileSwitch, APT, ClockWorks, The Embedded Control Solutions Company, EtherSynch, FlashTec, Hyper Speed Control, HyperLight Load, IntelliMOS, Libero, motorBench, mTouch, Powermite 3, Precision Edge, ProASIC, ProASIC Plus, ProASIC Plus logo, Quiet-Wire, SmartFusion, SyncWorld, Temux, TimeCesium, TimeHub, TimePictra, TimeProvider, WinPath, and ZL are registered trademarks of Microchip Technology Incorporated in the U.S.A.

Adjacent Key Suppression, AKS, Analog-for-the-Digital Age, Any Capacitor, AnyIn, AnyOut, Augmented Switching, BlueSky, BodyCom, CodeGuard, CryptoAuthentication, CryptoAutomotive, CryptoCompanion, CryptoController, dsPICDEM, dsPICDEM.net, Dynamic Average Matching, DAM, ECAN, Espresso T1S, EtherGREEN, IdealBridge, In-Circuit Serial Programming, ICSP, INICnet, Intelligent Paralleling, Inter-Chip Connectivity, JitterBlocker, maxCrypto, maxView, memBrain, Mindi, MiWi, MPASM, MPF, MPLAB Certified logo, MPLIB, MPLINK, MultiTRAK, NetDetach, Omniscient Code Generation, PICDEM, PICDEM.net, PICkit, PICtail, PowerSmart, PureSilicon, QMatrix, REAL ICE, Ripple Blocker, RTAX, RTG4, SAM-ICE, Serial Quad I/O, simpleMAP, SimpliPHY, SmartBuffer, SMART-I.S., storClad, SQI, SuperSwitcher, SuperSwitcher II, Switchtec, SynchroPHY, Total Endurance, TSHARC, USBCheck, VariSense, VectorBlox, VeriPHY, ViewSpan, WiperLock, XpressConnect, and ZENA are trademarks of Microchip Technology Incorporated in the U.S.A. and other countries.

SQTP is a service mark of Microchip Technology Incorporated in the U.S.A.

The Adaptec logo, Frequency on Demand, Silicon Storage Technology, and Symmcom are registered trademarks of Microchip Technology Inc. in other countries.

GestIC is a registered trademark of Microchip Technology Germany II GmbH & Co. KG, a subsidiary of Microchip Technology Inc., in other countries.

All other trademarks mentioned herein are property of their respective companies.

© 2020, Microchip Technology Incorporated, All Rights Reserved.

ISBN: 978-1-5224-7158-5

For information regarding Microchip's Quality Management Systems, please visit [www.microchip.com/quality](http://www.microchip.com/quality).



# MICROCHIP

## Worldwide Sales and Service

### AMERICAS

**Corporate Office**  
2355 West Chandler Blvd.  
Chandler, AZ 85224-6199  
Tel: 480-792-7200  
Fax: 480-792-7277  
Technical Support:  
<http://www.microchip.com/support>  
Web Address:  
[www.microchip.com](http://www.microchip.com)

#### Atlanta

Duluth, GA  
Tel: 678-957-9614  
Fax: 678-957-1455

#### Austin, TX

Tel: 512-257-3370

#### Boston

Westborough, MA  
Tel: 774-760-0087  
Fax: 774-760-0088

#### Chicago

Itasca, IL  
Tel: 630-285-0071  
Fax: 630-285-0075

#### Dallas

Addison, TX  
Tel: 972-818-7423  
Fax: 972-818-2924

#### Detroit

Novi, MI  
Tel: 248-848-4000

#### Houston, TX

Tel: 281-894-5983

#### Indianapolis

Noblesville, IN  
Tel: 317-773-8323  
Fax: 317-773-5453  
Tel: 317-536-2380

#### Los Angeles

Mission Viejo, CA  
Tel: 949-462-9523  
Fax: 949-462-9608  
Tel: 951-273-7800

#### Raleigh, NC

Tel: 919-844-7510

#### New York, NY

Tel: 631-435-6000

#### San Jose, CA

Tel: 408-735-9110  
Tel: 408-436-4270

#### Canada - Toronto

Tel: 905-695-1980  
Fax: 905-695-2078

### ASIA/PACIFIC

**Australia - Sydney**  
Tel: 61-2-9868-6733

**China - Beijing**  
Tel: 86-10-8569-7000

**China - Chengdu**  
Tel: 86-28-8665-5511

**China - Chongqing**  
Tel: 86-23-8980-9588

**China - Dongguan**  
Tel: 86-769-8702-9880

**China - Guangzhou**  
Tel: 86-20-8755-8029

**China - Hangzhou**  
Tel: 86-571-8792-8115

**China - Hong Kong SAR**  
Tel: 852-2943-5100

**China - Nanjing**  
Tel: 86-25-8473-2460

**China - Qingdao**  
Tel: 86-532-8502-7355

**China - Shanghai**  
Tel: 86-21-3326-8000

**China - Shenyang**  
Tel: 86-24-2334-2829

**China - Shenzhen**  
Tel: 86-755-8864-2200

**China - Suzhou**  
Tel: 86-186-6233-1526

**China - Wuhan**  
Tel: 86-27-5980-5300

**China - Xian**  
Tel: 86-29-8833-7252

**China - Xiamen**  
Tel: 86-592-2388138

**China - Zhuhai**  
Tel: 86-756-3210040

### ASIA/PACIFIC

**India - Bangalore**  
Tel: 91-80-3090-4444

**India - New Delhi**  
Tel: 91-11-4160-8631

**India - Pune**  
Tel: 91-20-4121-0141

**Japan - Osaka**  
Tel: 81-6-6152-7160

**Japan - Tokyo**  
Tel: 81-3-6880-3770

**Korea - Daegu**  
Tel: 82-53-744-4301

**Korea - Seoul**  
Tel: 82-2-554-7200

**Malaysia - Kuala Lumpur**  
Tel: 60-3-7651-7906

**Malaysia - Penang**  
Tel: 60-4-227-8870

**Philippines - Manila**  
Tel: 63-2-634-9065

**Singapore**  
Tel: 65-6334-8870

**Taiwan - Hsin Chu**  
Tel: 886-3-577-8366

**Taiwan - Kaohsiung**  
Tel: 886-7-213-7830

**Taiwan - Taipei**  
Tel: 886-2-2508-8600

**Thailand - Bangkok**  
Tel: 66-2-694-1351

**Vietnam - Ho Chi Minh**  
Tel: 84-28-5448-2100

### EUROPE

**Austria - Wels**  
Tel: 43-7242-2244-39  
Fax: 43-7242-2244-393

**Denmark - Copenhagen**  
Tel: 45-4485-5910  
Fax: 45-4485-2829

**Finland - Espoo**  
Tel: 358-9-4520-820

**France - Paris**  
Tel: 33-1-69-53-63-20  
Fax: 33-1-69-30-90-79

**Germany - Garching**  
Tel: 49-8931-9700

**Germany - Haan**  
Tel: 49-2129-3766400

**Germany - Heilbronn**  
Tel: 49-7131-72400

**Germany - Karlsruhe**  
Tel: 49-721-625370

**Germany - Munich**  
Tel: 49-89-627-144-0  
Fax: 49-89-627-144-44

**Germany - Rosenheim**  
Tel: 49-8031-354-560

**Israel - Ra'anana**  
Tel: 972-9-744-7705

**Italy - Milan**  
Tel: 39-0331-742611  
Fax: 39-0331-466781

**Italy - Padova**  
Tel: 39-049-7625286

**Netherlands - Drunen**  
Tel: 31-416-690399  
Fax: 31-416-690340

**Norway - Trondheim**  
Tel: 47-7288-4388

**Poland - Warsaw**  
Tel: 48-22-3325737

**Romania - Bucharest**  
Tel: 40-21-407-87-50

**Spain - Madrid**  
Tel: 34-91-708-08-90  
Fax: 34-91-708-08-91

**Sweden - Gothenberg**  
Tel: 46-31-704-60-40

**Sweden - Stockholm**  
Tel: 46-8-5090-4654

**UK - Wokingham**  
Tel: 44-118-921-5800  
Fax: 44-118-921-5820