

MAX2022

High-Dynamic-Range, Direct Up/Downconversion 1500MHz to 3000MHz Quadrature Modulator/Demodulator

General Description

The MAX2022 low-noise, high-linearity, direct conversion quadrature modulator/demodulator is designed for single and multicarrier 1500MHz to 3000MHz UMTS/WCDMA, LTE/TD-LTE, cdma2000®, and DCS/PCS base-station applications. Direct conversion architectures are advantageous since they significantly reduce transmitter or receiver cost, part count, and power consumption as compared to traditional IF-based double conversion systems.

In addition to offering excellent linearity and noise performance, the MAX2022 also yields a high level of component integration. This device includes two matched passive mixers for modulating or demodulating in-phase and quadrature signals, three LO mixer amplifier drivers, and an LO quadrature splitter. On-chip baluns are also integrated to allow for single-ended RF and LO connections. As an added feature, the baseband inputs have been matched to allow for direct interfacing to the transmit DAC, thereby eliminating the need for costly I/Q buffer amplifiers.

The MAX2022 operates from a single +5V supply. It is available in a compact 36-pin TQFN package (6mm x 6mm) with an exposed paddle. Electrical performance is guaranteed over the extended -40°C to +85°C temperature range.

Applications

- Single and Multicarrier WCDMA/UMTS and LTE/TD-LTE Base Stations
- Single and Multicarrier cdmaOne™ and cdma2000 Base Stations
- Single and Multicarrier DCS 1800/PCS 1900 EDGE Base Stations
- PHS/PAS Base Stations
- Predistortion Transmitters
- Fixed Broadband Wireless Access
- Wireless Local Loop
- Private Mobile Radio
- Military Systems
- Microwave Links
- Digital and Spread-Spectrum Communication Systems

cdma2000 is a registered trademark of Telecommunications Industry Association.

cdmaOne is a trademark of CDMA Development Group.

Benefits and Features

- 1500MHz to 3000MHz RF Frequency Range
- 1500MHz to 3000MHz LO Frequency Range
- Scalable Power: External Current-Setting Resistors Provide Option for Operating Device in Reduced-Power/Reduced-Performance Mode
- 36-Pin, 6mm x 6mm TQFN Provides High Isolation in a Small Package

Modulator Operation (2140MHz):

- Meets Four-Carrier WCDMA 65dBc ACLR
- 23.3dBm Typical OIP3
- 51.5dBm Typical OIP2
- 45.7dBc Typical Sideband Suppression
- -40dBm Typical LO Leakage
- -173.2dBm/Hz Typical Output Noise, Eliminating the Need for an RF Output Filter
- Broadband Baseband Input
- DC-Coupled Input Provides for Direct Launch DAC Interface, Eliminating the Need for Costly I/Q Buffer Amplifiers

Demodulator Operation (1890MHz):

- 39dBm Typical IIP3
- 58dBm Typical IIP2
- 9.2dB Typical Conversion Loss
- 9.4dB Typical NF

Ordering Information appears at end of data sheet.

For related parts and recommended products to use with this part, refer to www.maximintegrated.com/MAX2022.related.

WCDMA, ACLR, ALTCLR and Noise vs. RF Output Power at 2140MHz for Single, Two, and Four Carriers

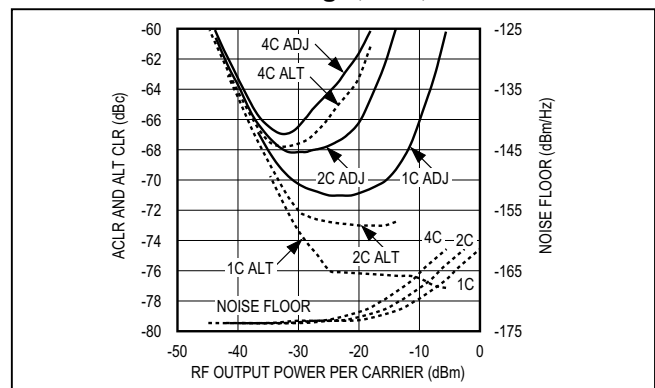

Absolute Maximum Ratings

VCC_ to GND.....	-0.3V to +5.5V	RBIASLO3 Maximum Current.....	10mA
BBIP, BBIN, BBQP, BBQN to GND.....	-2.5V to (V _{CC} + 0.3V)	Continuous Power Dissipation (Note 1).....	7.6W
LO, RF to GND Maximum Current.....	50mA	Operating Case Temperature Range (Note 2) ...	-40°C to +85°C
RF Input Power.....	+20dBm	Maximum Junction Temperature.....	+150°C
Baseband Differential I/Q Input Power.....	+20dBm	Storage Temperature Range.....	-65°C to +150°C
LO Input Power.....	+10dBm	Lead Temperature (soldering, 10s).....	+300°C
RBIASLO1 Maximum Current.....	10mA	Soldering Temperature (reflow).....	+260°C
RBIASLO2 Maximum Current.....	10mA		

Note 1: Based on junction temperature $T_J = T_C + (\theta_{JC} \times V_{CC} \times I_{CC})$. This formula can be used when the temperature of the exposed pad is known while the device is soldered down to a PCB. See the [Applications Information](#) section for details. The junction temperature must not exceed +150°C.

Note 2: T_C is the temperature on the exposed pad of the package. T_A is the ambient temperature of the device and PCB.

Stresses beyond those listed under "Absolute Maximum Ratings" may cause permanent damage to the device. These are stress ratings only, and functional operation of the device at these or any other conditions beyond those indicated in the operational sections of the specifications is not implied. Exposure to absolute maximum rating conditions for extended periods may affect device reliability.

Package Thermal Characteristics

TQFN

Junction-to-Ambient		Junction-to-Case	
Thermal Resistance (θ_{JA}) (Notes 3, 4).....	+34°C/W	Thermal Resistance (θ_{JC}) (Notes 1, 4).....	+8.5°C/W

Note 3: Junction temperature $T_J = T_A + (\theta_{JA} \times V_{CC} \times I_{CC})$. This formula can be used when the ambient temperature of the PCB is known. The junction temperature must not exceed +150°C.

Note 4: Package thermal resistances were obtained using the method described in JEDEC specification JESD51-7, using a four-layer board. For detailed information on package thermal considerations, refer to www.maximintegrated.com/thermal-tutorial.

DC Electrical Characteristics

(MAX2022 [Typical Application Circuit](#), $V_{CC} = 4.75V$ to $5.25V$, $V_{GND} = 0V$, I/Q ports terminated into 50Ω to GND, LO and RF ports terminated into 50Ω to GND, $R1 = 432\Omega$, $R2 = 562\Omega$, $R3 = 301\Omega$, $T_C = -40^\circ C$ to $+85^\circ C$, unless otherwise noted. Typical values are at $V_{CC} = 5V$, $T_C = +25^\circ C$, unless otherwise noted.)

PARAMETER	SYMBOL	CONDITIONS	MIN	TYP	MAX	UNITS
Supply Voltage	V _{CC}		4.75	5.00	5.25	V
Total Supply Current	I _{TOTAL}	Pins 3, 13, 15, 31, 33 all connected to V _{CC}		292	342	mA
Total Power Dissipation				1460	1796	mW

Recommended AC Operating Conditions

PARAMETER	SYMBOL	CONDITIONS	MIN	TYP	MAX	UNITS
RF Frequency	f _{RF}	(Note 5)	1500		3000	MHz
LO Frequency	f _{LO}	(Note 5)	1500		3000	MHz
IF Frequency	f _{IF}	(Note 5)			1000	MHz
LO Power Range	P _{LO}		-3		+3	dBm

AC Electrical Characteristics (Modulator)

(MAX2022 *Typical Application Circuit*, $V_{CC} = 4.75V$ to $5.25V$, $V_{GND} = 0V$, I/Q differential inputs driven from a 100Ω differential DC-coupled source, $0V$ common-mode input, $P_{LO} = 0dBm$, $f_{LO} = 1900MHz$ to $2200MHz$, 50Ω LO and RF system impedance, $R1 = 432\Omega$, $R2 = 562\Omega$, $R3 = 301\Omega$, $T_C = -40^\circ C$ to $+85^\circ C$. Typical values are at $V_{CC} = 5V$, $V_{BBI} = 109mV_{P-P}$ differential, $V_{BBQ} = 109mV_{P-P}$ differential, $f_{IQ} = 1MHz$, $T_C = +25^\circ C$, unless otherwise noted.) (Notes 6, 7)

PARAMETER	SYMBOL	CONDITIONS	MIN	TYP	MAX	UNITS
BASEBAND INPUT						
Baseband Input Differential Impedance				43		Ω
BB Common-Mode Input Voltage Range		(Note 8)	-2.5	0	+1.5	V
Output Power		$T_C = +25^\circ C$	-24			dBm
RF OUTPUTS ($f_{LO} = 1960MHz$)						
Output IP3		$V_{BBI}, V_{BBQ} = 547mV_{P-P}$ differential per tone into 50Ω , $f_{BB1} = 1.8MHz$, $f_{BB2} = 1.9MHz$		21.8		dBm
Output IP2		$V_{BBI}, V_{BBQ} = 547mV_{P-P}$ differential per tone into 50Ω , $f_{BB1} = 1.8MHz$, $f_{BB2} = 1.9MHz$		48.9		dBm
Output Power				-20.5		dBm
Output Power Variation Over Temperature		$T_C = -40^\circ C$ to $+85^\circ C$		-0.004		dB/ $^\circ C$
Output-Power Flatness		$f_{LO} = 1960MHz$, sweep f_{BB} , P_{RF} flatness for f_{BB} from $1MHz$ to $50MHz$		0.6		dB
ACLR (1st Adjacent Channel 5MHz Offset)		Single-carrier WCDMA (Note 9), $RFOUT = -16dBm$		70		dBc
LO Leakage		No external calibration, with each baseband input terminated in 50Ω to GND		-46.7		dBm
Sideband Suppression		No external calibration		47.3		dBc
RF Return Loss				15.3		dB
Output Noise Density		$f_{meas} = 2060MHz$ (Note 10)		-173.4		dBm/Hz
LO Input Return Loss				10.1		dB
RF OUTPUTS ($f_{LO} = 2140MHz$)						
Output IP3		$V_{BBI}, V_{BBQ} = 547mV_{P-P}$ differential per tone into 50Ω , $f_{BB1} = 1.8MHz$, $f_{BB2} = 1.9MHz$		23.3		dBm
Output IP2		$V_{BBI}, V_{BBQ} = 547mV_{P-P}$ differential per tone into 50Ω , $f_{BB1} = 1.8MHz$, $f_{BB2} = 1.9MHz$		51.5		dBm
Output Power				-20.8		dBm
Output Power Variation Over Temperature		$T_C = -40^\circ C$ to $+85^\circ C$		-0.005		dB/ $^\circ C$
Output-Power Flatness		$f_{LO} = 2140MHz$, sweep f_{BB} , P_{RF} flatness for f_{BB} from $1MHz$ to $50MHz$		0.32		dB

AC Electrical Characteristics (Modulator) (continued)

(MAX2022 *Typical Application Circuit*, $V_{CC} = 4.75V$ to $5.25V$, $V_{GND} = 0V$, I/Q differential inputs driven from a 100Ω differential DC-coupled source, $0V$ common-mode input, $P_{LO} = 0dBm$, $f_{LO} = 1900MHz$ to $2200MHz$, 50Ω LO and RF system impedance, $R1 = 432\Omega$, $R2 = 562\Omega$, $R3 = 301\Omega$, $T_C = -40^\circ C$ to $+85^\circ C$. Typical values are at $V_{CC} = 5V$, $V_{BBI} = 109mV_{P-P}$ differential, $V_{BBQ} = 109mV_{P-P}$ differential, $f_{IQ} = 1MHz$, $T_C = +25^\circ C$, unless otherwise noted.) (Notes 6, 7)

PARAMETER	SYMBOL	CONDITIONS	MIN	TYP	MAX	UNITS
ACLR (1st Adjacent Channel 5MHz Offset)		Single-carrier WCDMA (Note 9), RFOUT = -16dBm, $f_{LO} = 2GHz$		70		dBc
LO Leakage		No external calibration, with each baseband input terminated in 50Ω to GND		-40.4		dBm
Sideband Suppression		No external calibration		45.7		dBc
RF Return Loss				13.5		dB
Output Noise Density		$f_{meas} = 2240MHz$ (Note 10)		-173.2		dBm/Hz
LO Input Return Loss				18.1		dB

AC Electrical Characteristics (Demodulator, $f_{LO} = 1880MHz$)

(MAX2022 *Typical Application Circuit* when operated as a demodulator. I/Q outputs are recombined using network shown in [Figure 5](#). Losses of combining network not included in measurements. RF and LO ports are driven from 50Ω sources. Typical values are for $V_{CC} = 5V$, I/Q DC returns = 160Ω resistors to GND, $P_{RF} = 0dBm$, $P_{LO} = 0dBm$, $f_{RF} = 1890MHz$, $f_{LO} = 1880MHz$, $f_{IF} = 10MHz$, $T_C = +25^\circ C$, unless otherwise noted.) (Notes 6, 11)

PARAMETER	SYMBOL	CONDITIONS	MIN	TYP	MAX	UNITS
Conversion Loss	L_C			9.2		dB
Noise Figure	NF_{SSB}			9.4		dB
Input Third-Order Intercept Point	IIP3	$f_{RF1} = 1890MHz$, $f_{RF2} = 1891MHz$, $P_{RF1} = P_{RF2} = 0dBm$, $f_{IF1} = 10MHz$, $f_{IF2} = 11MHz$		39		dBm
Input Second-Order Intercept Point	IIP2	$f_{RF1} = 1890MHz$, $f_{RF2} = 1891MHz$, $P_{RF1} = P_{RF2} = 0dBm$, $f_{IF1} = 10MHz$, $f_{IF2} = 11MHz$, $f_{IM2nd} = 21MHz$		58		dBm
LO Leakage at RF Port		Unnulled		-40		dBm
Gain Compression		$P_{RF} = 20dBm$		0.10		dB
Image Rejection				35		dB
RF Port Return Loss		$C9 = 1.2pF$		17		dB
LO Port Return Loss		$C3 = 22pF$		9		dB
IF Port Differential Impedance				43		Ω
Minimum Demodulation 3dB Bandwidth				>500		MHz
Minimum 1dB Gain Flatness				>450		MHz

AC Electrical Characteristics (Demodulator, $f_{LO} = 2855\text{MHz}$)

(MAX2022 *Typical Application Circuit* when operated as a demodulator. I/Q outputs are recombined using network shown in [Figure 5](#). Losses of combining network not included in measurements. RF and LO ports are driven from 50Ω sources. Typical values are for $V_{CC} = 5\text{V}$, I/Q DC returns = 160Ω resistors to GND, $P_{RF} = 0\text{dBm}$, $P_{LO} = 0\text{dBm}$, $f_{RF} = 2655\text{MHz}$, $f_{LO} = 2855\text{MHz}$, $f_{IF} = 200\text{MHz}$, $T_C = +25^\circ\text{C}$, unless otherwise noted.) (Notes 6, 11)

PARAMETER	SYMBOL	CONDITIONS	MIN	TYP	MAX	UNITS
Conversion Loss	L_C			11.2		dB
Noise Figure	NF_{SSB}			11.4		dB
Input Third-Order Intercept Point	IIP3	$f_{RF1} = 2655\text{MHz}$, $f_{RF2} = 2656.2\text{MHz}$, $P_{RF1} = P_{RF2} = 0\text{dBm}$, $f_{IF1} = 200\text{MHz}$, $f_{IF2} = 198.8\text{MHz}$		34.5		dBm
Input Second-Order Intercept Point	IIP2	$f_{RF1} = 2655\text{MHz}$, $f_{RF2} = 2656.2\text{MHz}$, $P_{RF1} = P_{RF2} = 0\text{dBm}$, $f_{IF1} = 200\text{MHz}$, $f_{IF2} = 198.8\text{MHz}$, $f_{IM2nd} = 398.8\text{MHz}$		60		dBm
LO Leakage at RF Port				-31.3		dBm
LO Leakage at IF Port		I+		-25.2		dBm
		I-		-23.5		
		Q+		-26		
		Q-		-22.3		
Gain Compression		$P_{RF} = 20\text{dBm}$		0.10		dB
I/Q Gain Mismatch				0.3		dB
I/Q Phase Mismatch				0.5		deg
RF Port Return Loss		$C9 = 22\text{pF}$, $L1 = 4.7\text{nH}$, $C14 = 0.7\text{pF}$		22.5		dB
LO Port Return Loss		$C3 = 6.8\text{pF}$		14.2		dB
IF Port Differential Impedance				43		Ω
Minimum Demodulation 3dB Bandwidth				>500		MHz
Minimum 1dB Gain Flatness				>450		MHz

Note 5: Recommended functional range, not production tested. Operation outside this range is possible, but with degraded performance of some parameters.

Note 6: All limits include external component losses of components, PCB, and connectors.

Note 7: It is advisable not to operate the I and Q inputs continuously above 2.5V_{p-p} differential.

Note 8: Guaranteed by design and characterization.

Note 9: Single-carrier WCDMA peak-to-average ratio of 10.5dB for 0.1% complementary cumulative distribution function.

Note 10: No baseband drive input. Measured with the baseband inputs terminated in 50Ω to GND. At low-output power levels, the output noise density is equal to the thermal noise floor.

Note 11: It is advisable not to operate the RF input continuously above +17dBm.

Typical Operating Characteristics

(MAX2022 *Typical Application Circuit*, 50Ω LO input, R1 = 432Ω, R2 = 562Ω, R3 = 301Ω, V_{CC} = 5V, P_{LO} = 0dBm, f_{LO} = 2140MHz, V_I = V_Q = 109mV_{P-P} differential, f_{IQ} = 1MHz, I/Q differential inputs driven from a 100Ω differential DC-coupled source, common-mode input from 0V, T_C = +25°C, unless otherwise noted.)

MODULATOR

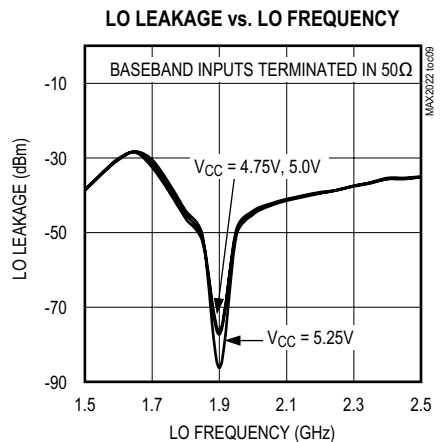
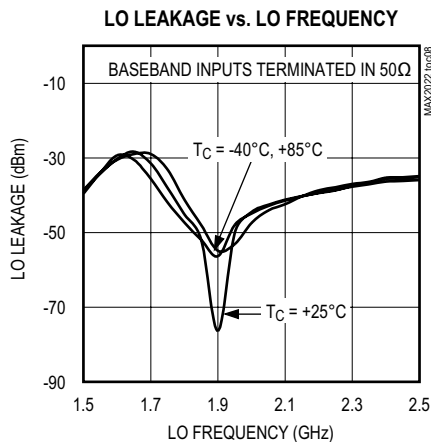
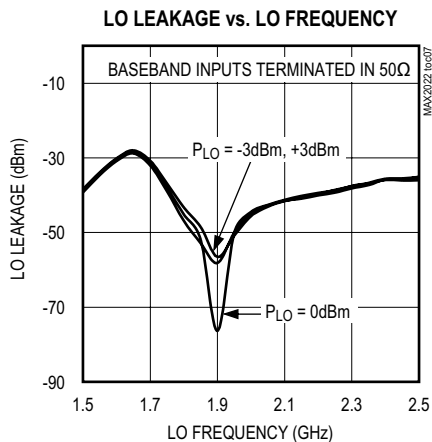
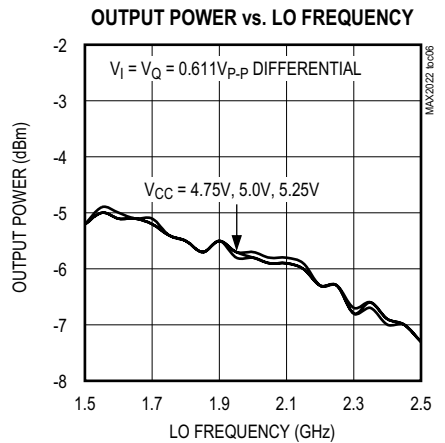
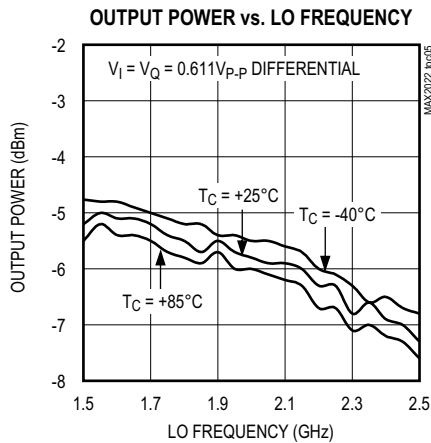
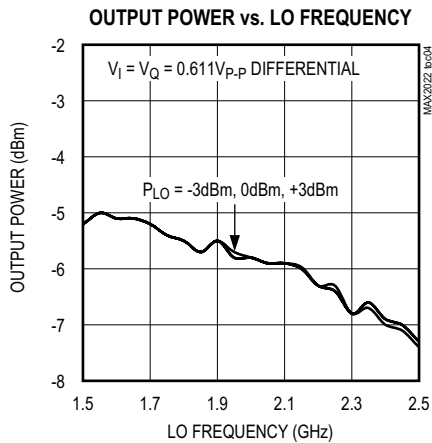
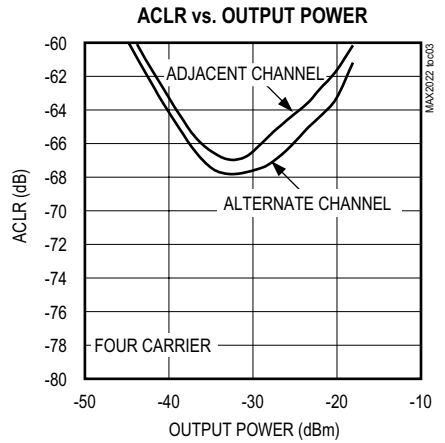
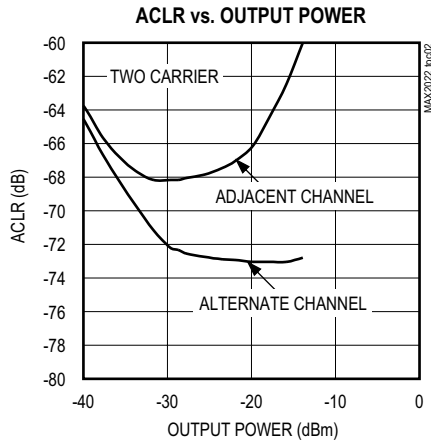
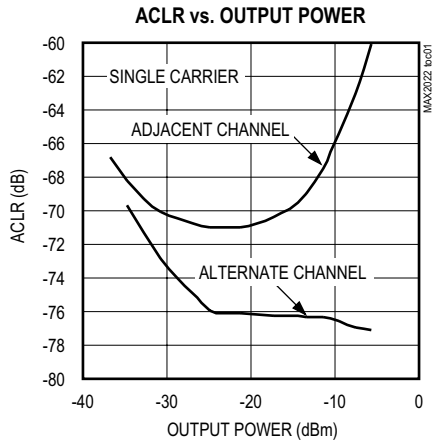

Typical Operating Characteristics (continued)

(MAX2022 *Typical Application Circuit*, 50Ω LO input, R1 = 432Ω, R2 = 562Ω, R3 = 301Ω, V_{CC} = 5V, P_{LO} = 0dBm, f_{LO} = 2140MHz, V_I = V_Q = 109mV_{P-P} differential, f_{IQ} = 1MHz, I/Q differential inputs driven from a 100Ω differential DC-coupled source, common-mode input from 0V, T_C = +25°C, unless otherwise noted.)

MODULATOR

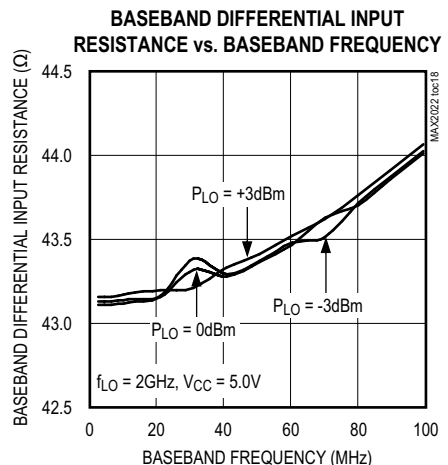
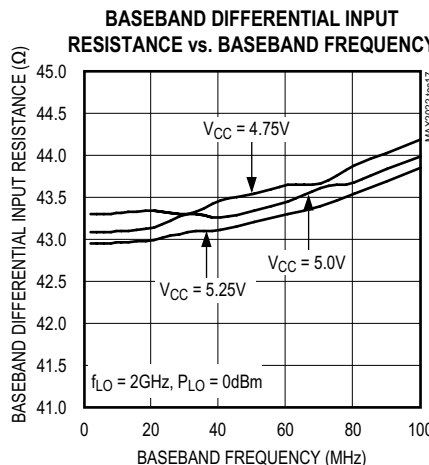
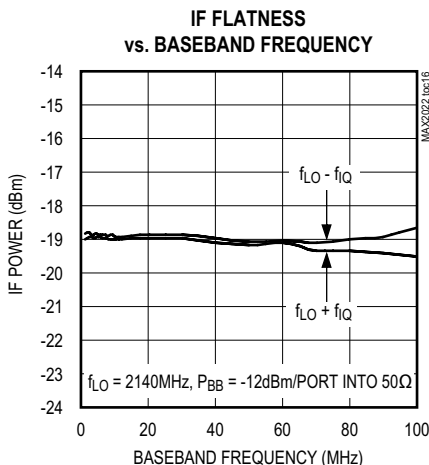
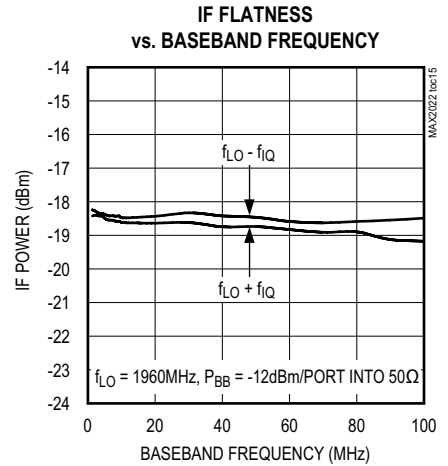
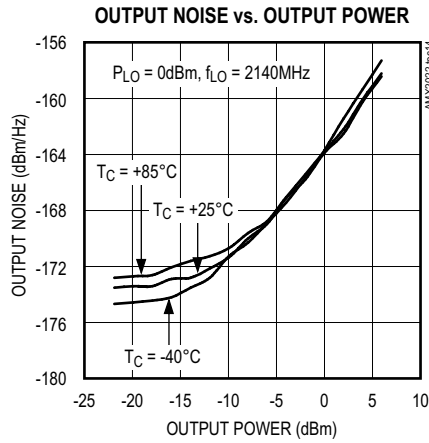
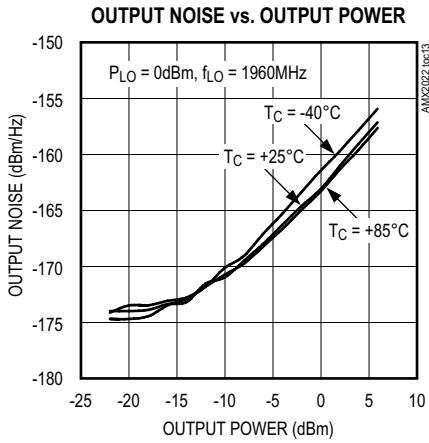
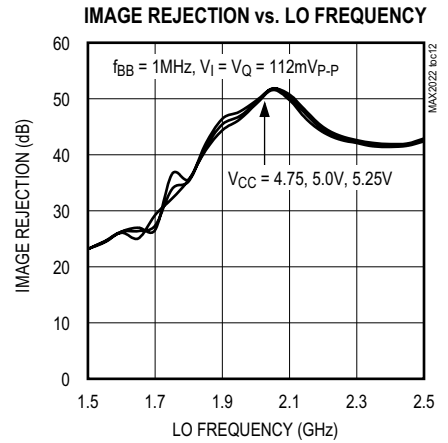
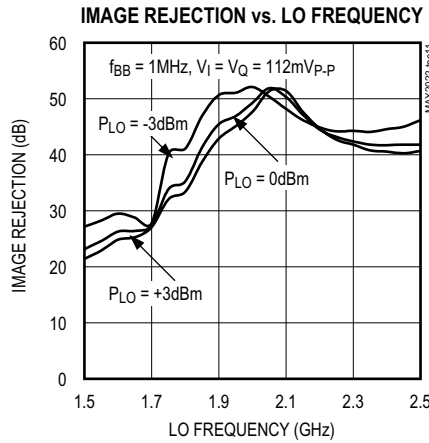
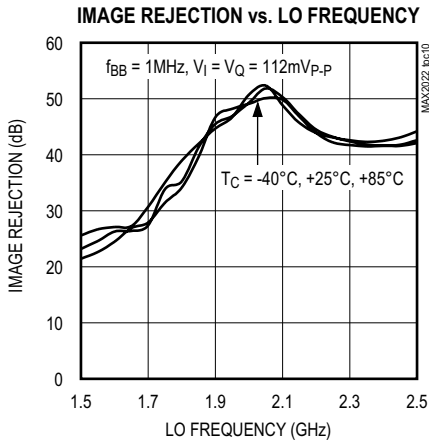

Typical Operating Characteristics (continued)

(MAX2022 [Typical Application Circuit](#), 50 μ W LO input, R1 = 432 Ω , R2 = 562 Ω , R3 = 301 Ω , V_{CC} = 5V, P_{LO} = 0dBm, f_{LO} = 2140MHz, V_I = V_Q = 109mV_{P-P} differential, f_{IQ} = 1MHz, I/Q differential inputs driven from a 100 Ω differential DC-coupled source, common-mode input from 0V, T_C = +25 $^{\circ}$ C, unless otherwise noted.)

MODULATOR

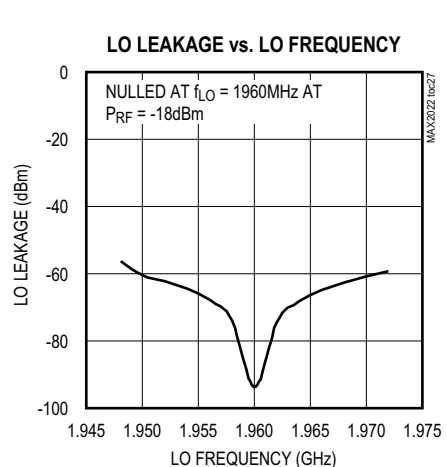
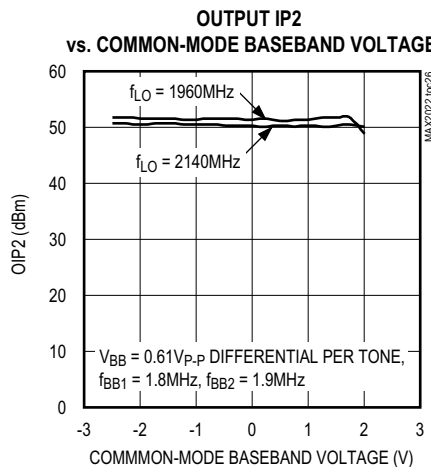
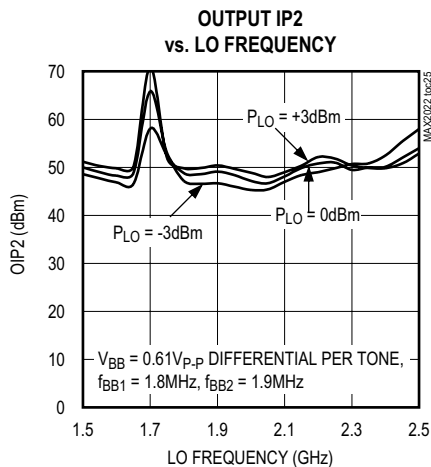
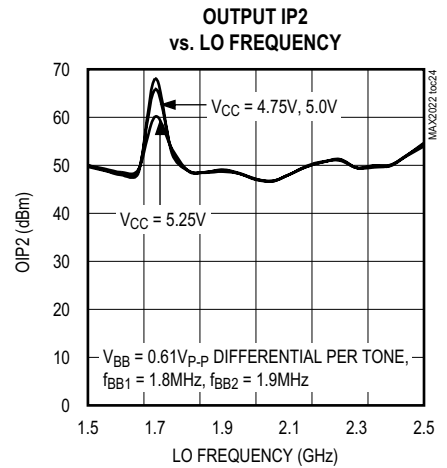
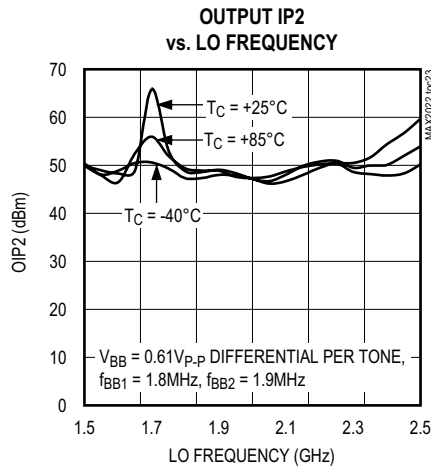
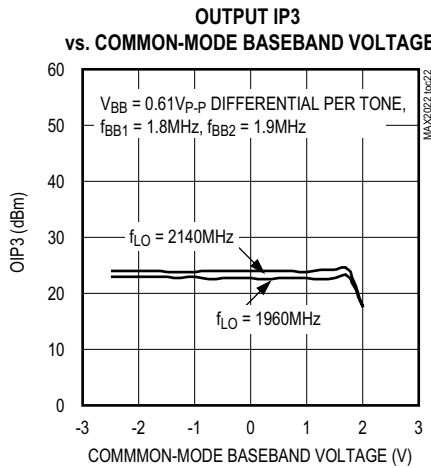
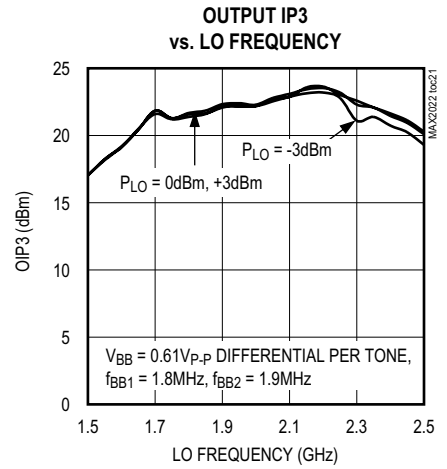
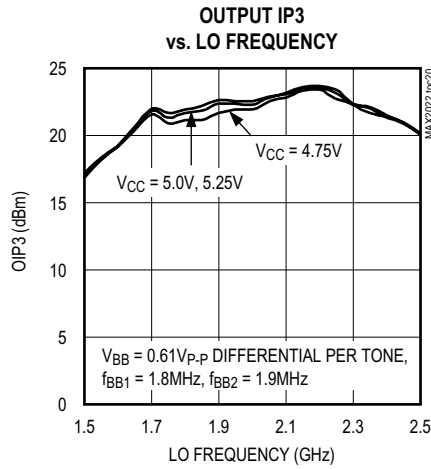
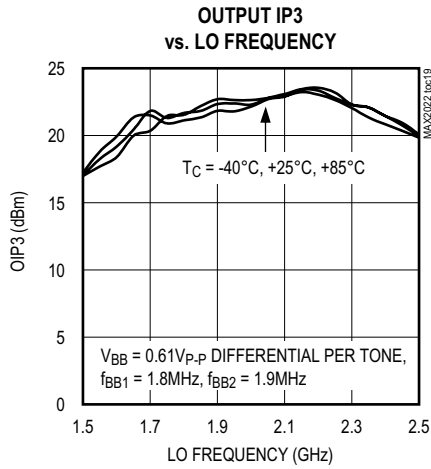

Typical Operating Characteristics (continued)

(MAX2022 *Typical Application Circuit*, 50Ω LO input, R1 = 432Ω, R2 = 562Ω, R3 = 301Ω, V_{CC} = 5V, P_{LO} = 0dBm, f_{LO} = 2140MHz, V_I = V_Q = 109mV_{P-P} differential, f_{IQ} = 1MHz, I/Q differential inputs driven from a 100Ω differential DC-coupled source, common-mode input from 0V, T_C = +25°C, unless otherwise noted.)

MODULATOR

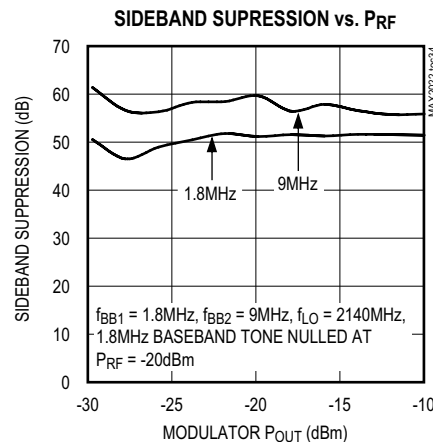
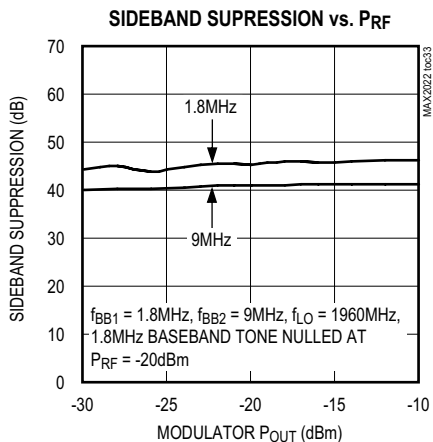
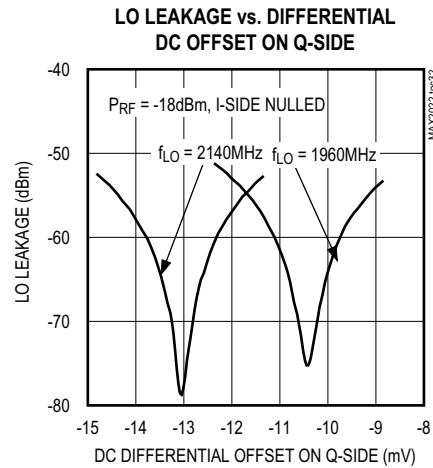
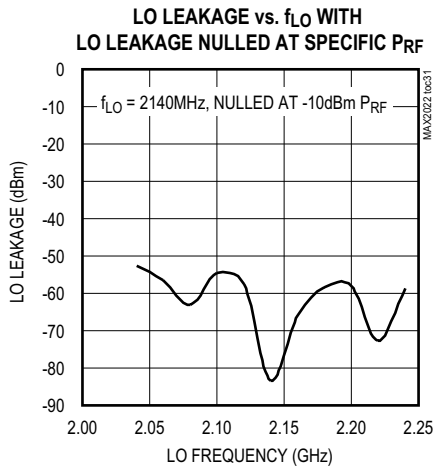
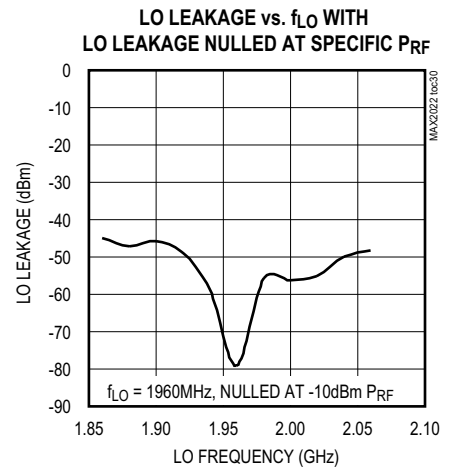
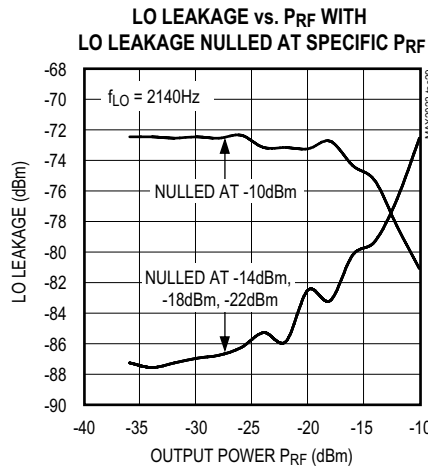
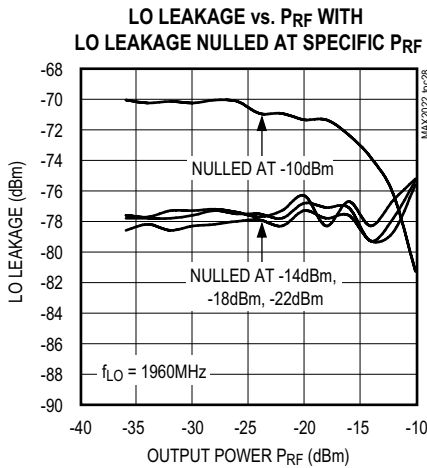

Typical Operating Characteristics (continued)

(MAX2022 *Typical Application Circuit*, 50Ω LO input, R1 = 432Ω, R2 = 562Ω, R3 = 301Ω, V_{CC} = 5V, P_{LO} = 0dBm, f_{LO} = 2140MHz, V_I = V_Q = 109mV_{P-P} differential, f_{IQ} = 1MHz, I/Q differential inputs driven from a 100Ω differential DC-coupled source, common-mode input from 0V, T_C = +25°C, unless otherwise noted.)

MODULATOR

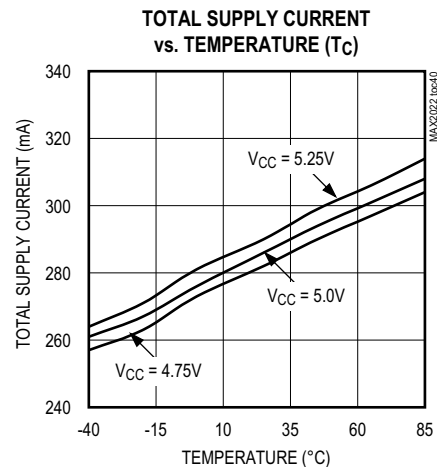
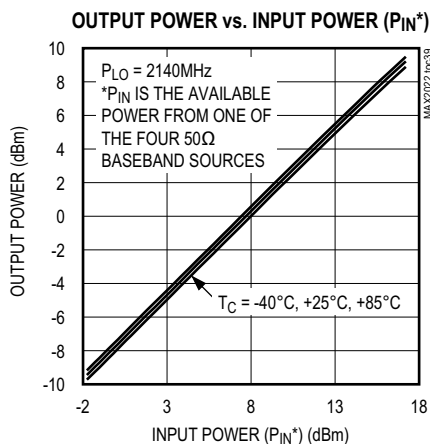
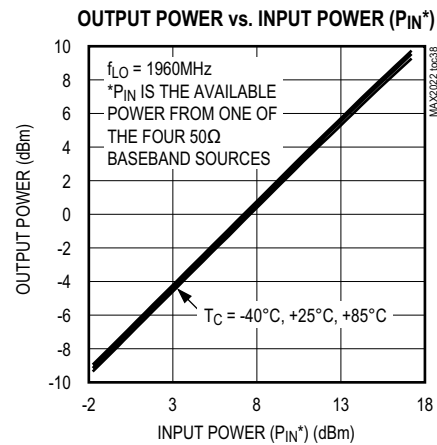
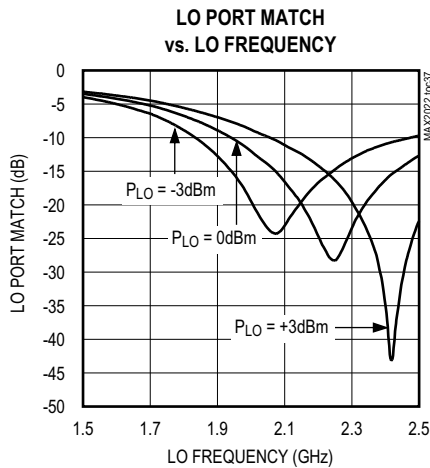
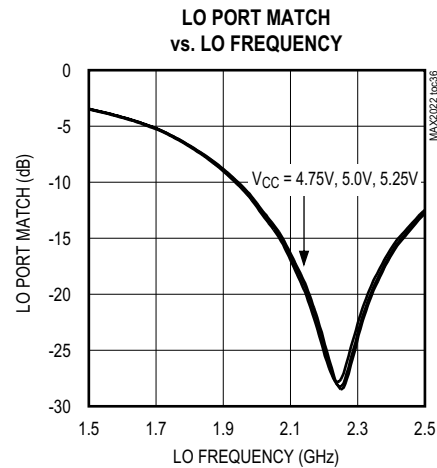
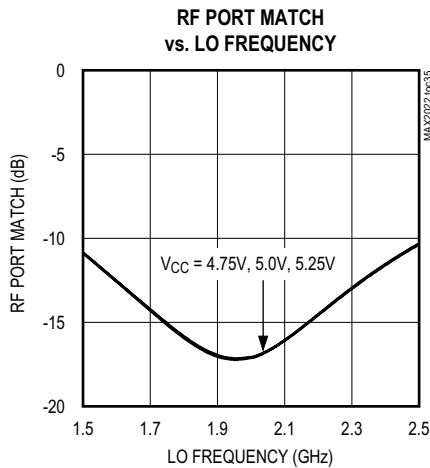

Typical Operating Characteristics (continued)

(MAX2022 *Typical Application Circuit*, 50Ω LO input, R1 = 432Ω, R2 = 562Ω, R3 = 301Ω, V_{CC} = 5V, P_{LO} = 0dBm, f_{LO} = 2140MHz, V_I = V_Q = 109mV_{P-P} differential, f_{IQ} = 1MHz, I/Q differential inputs driven from a 100Ω differential DC-coupled source, common-mode input from 0V, T_C = +25°C, unless otherwise noted.)

MODULATOR

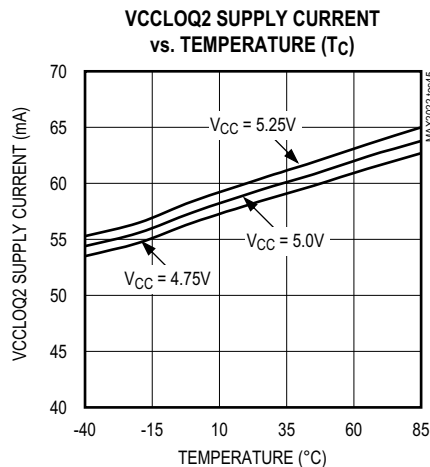
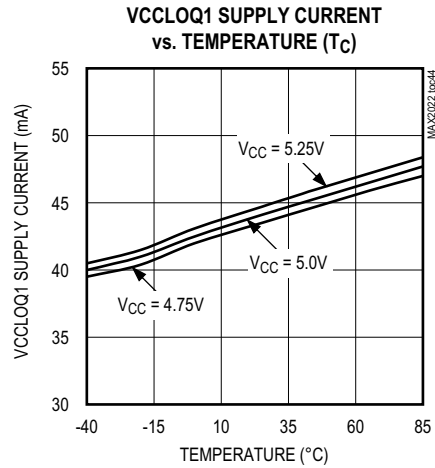
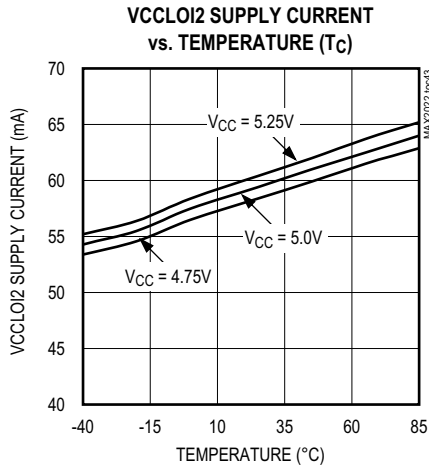
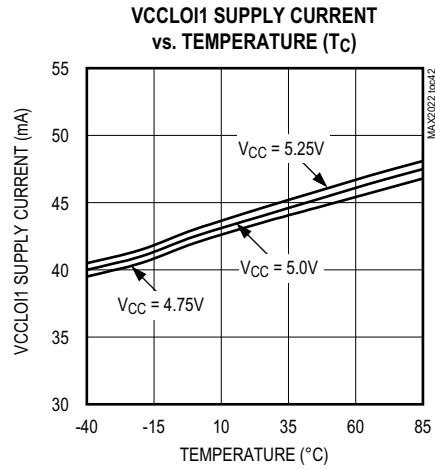
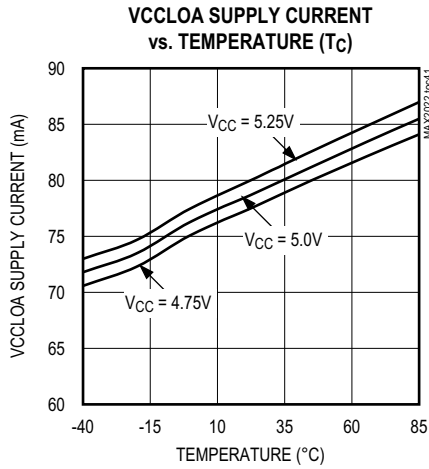

Typical Operating Characteristics

(MAX2022 *Typical Application Circuit*, RF and LO ports tuned for 1500MHz to 2400MHz as noted in [Table 1](#). I/Q outputs are recombined using network shown in [Figure 5](#). Losses of combining network not included in measurements. $V_{CC} = 5.0V$, $GND = 0V$, $P_{RF} = 0dBm$, $P_{LO} = 0dBm$, $f_{IF} = 20MHz$, $f_{LO} > f_{RF}$, intermodulation delta frequency = 1.2MHz, 50Ω LO and RF system impedance, $T_C = +25^\circ C$ unless otherwise noted.)

DEMODULATOR LOW BAND TUNING (VARIABLE LO)

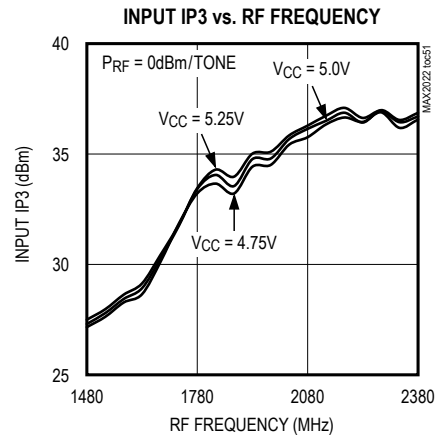
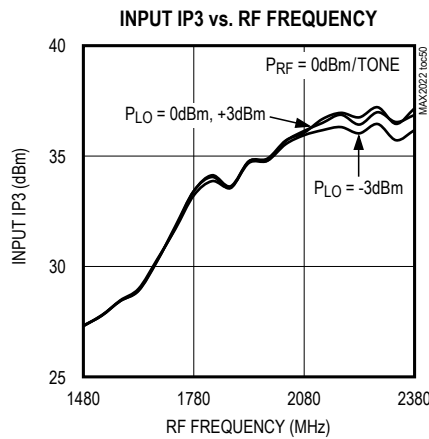
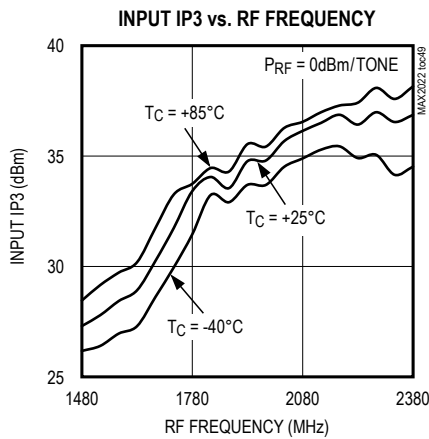
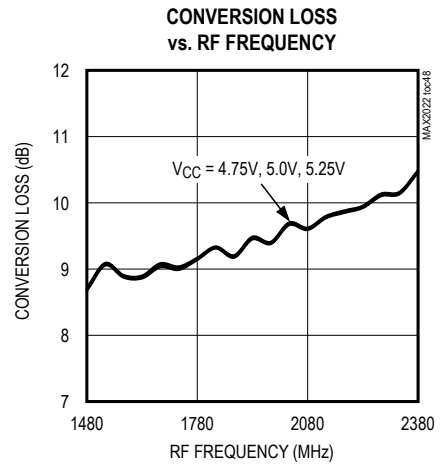
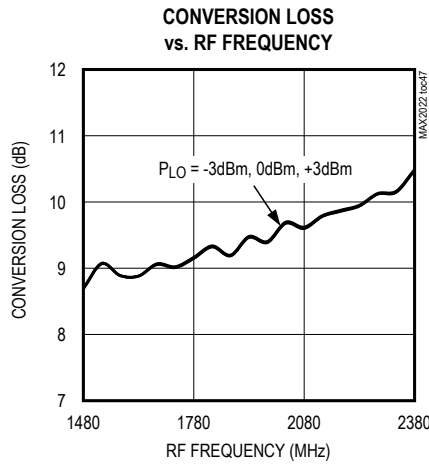
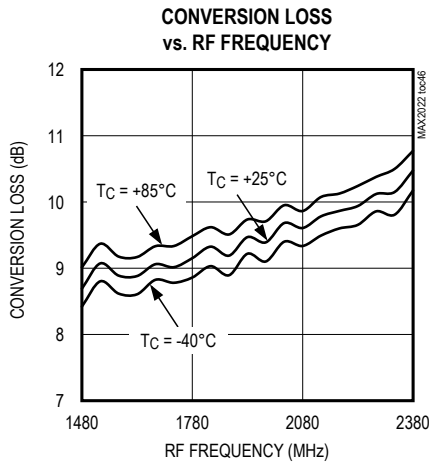

Typical Operating Characteristics (continued)

(MAX2022 *Typical Application Circuit*, RF and LO ports tuned for 1500MHz to 2400MHz as noted in [Table 1](#). I/Q outputs are recombined using network shown in [Figure 5](#). Losses of combining network not included in measurements. $V_{CC} = 5.0V$, $GND = 0V$, $P_{RF} = 0dBm$, $P_{LO} = 0dBm$, $f_{IF} = 20MHz$, $f_{LO} > f_{RF}$, intermodulation delta frequency = 1.2MHz, 50Ω LO and RF system impedance, $T_C = +25^{\circ}C$ unless otherwise noted.)

DEMODULATOR LOW BAND TUNING (VARIABLE LO)

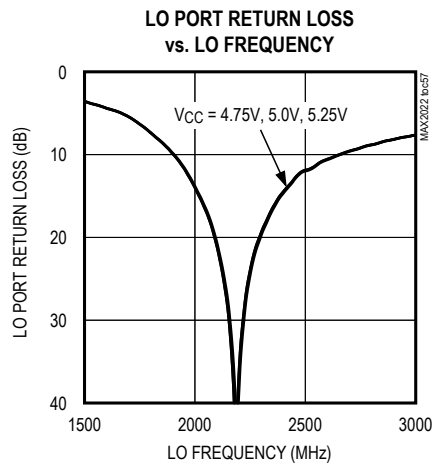
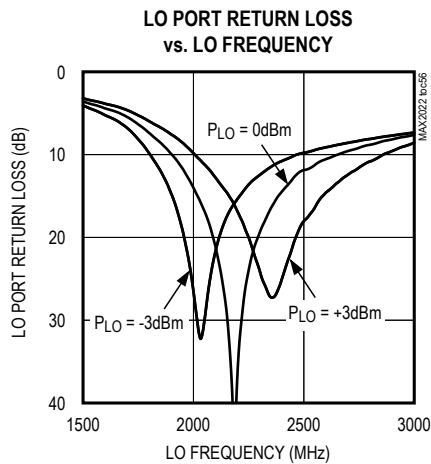
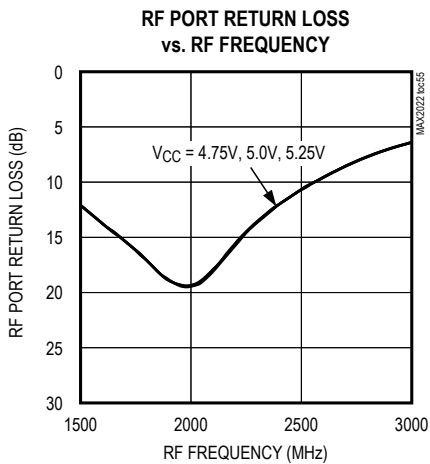
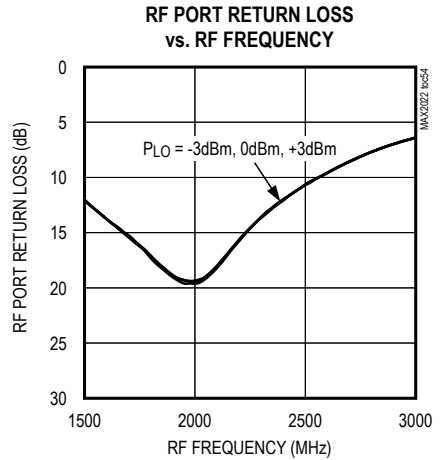
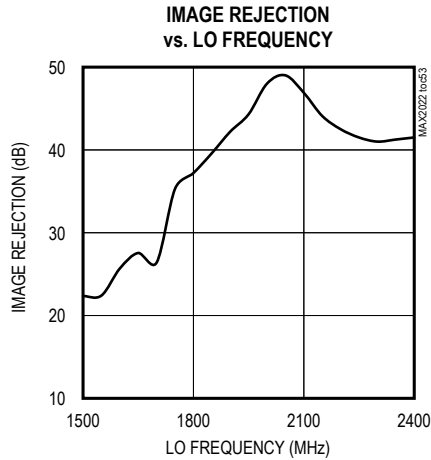
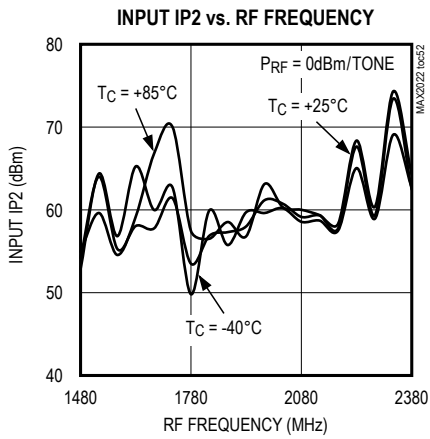

Typical Operating Characteristics

(MAX2022 *Typical Application Circuit*, RF and LO ports tuned for 2400MHz to 3000MHz as noted in [Table 1](#). I/Q outputs are recombined using network shown in [Figure 5](#). Losses of combining network not included in measurements. $V_{CC} = 5.0V$, $GND = 0V$, $P_{RF} = 0dBm$, $P_{LO} = 0dBm$, $f_{IF} = 20MHz$, $f_{LO} > f_{RF}$, intermodulation delta frequency = 1.2MHz, 50Ω LO and RF system impedance, $T_C = +25^{\circ}C$, unless otherwise noted.)

DEMODULATOR HIGH BAND TUNING (VARIABLE LO)

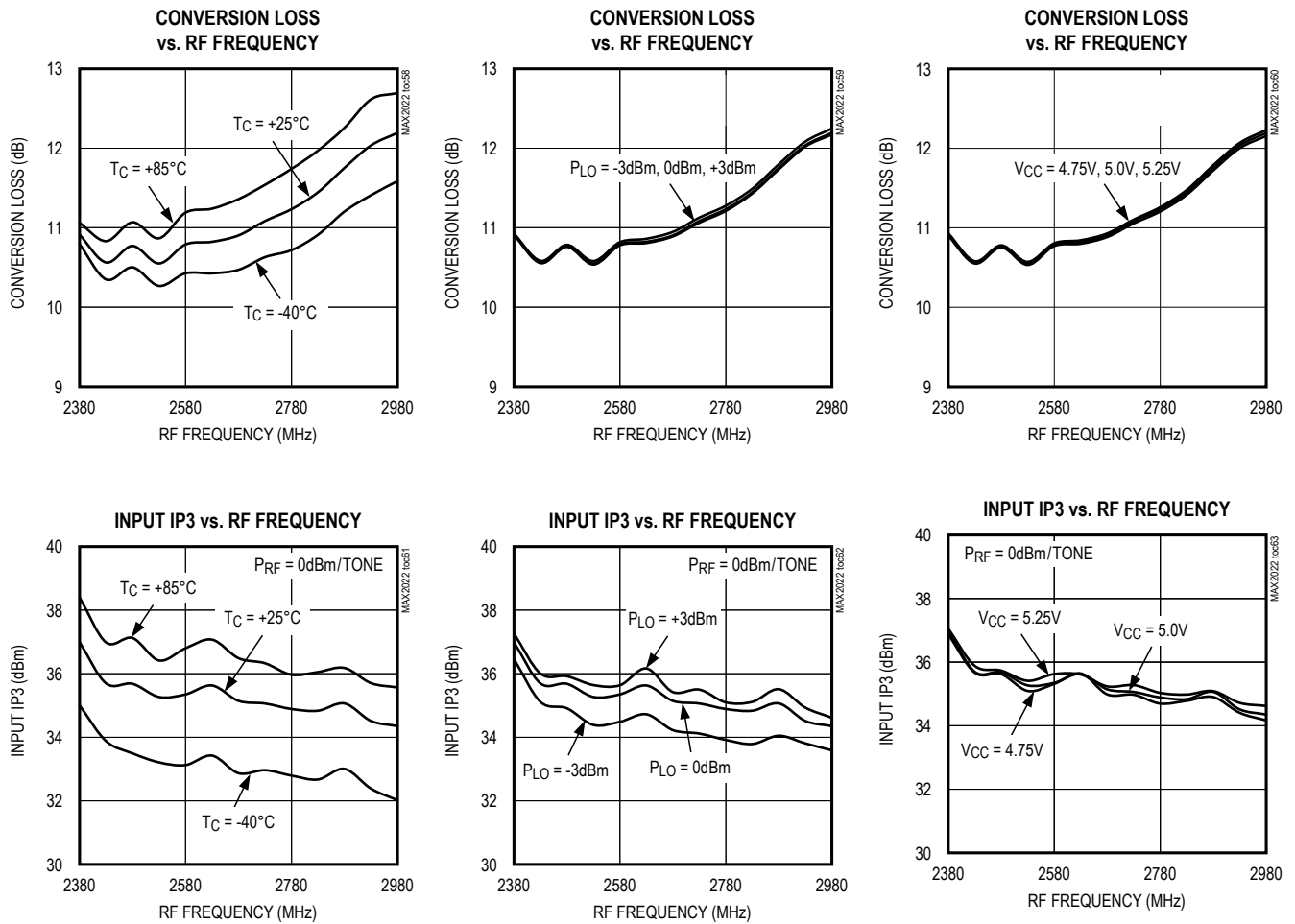

Typical Operating Characteristics (continued)

(MAX2022 *Typical Operating Characteristics*, RF and LO ports tuned for 2400MHz to 3000MHz as noted in Table 1. I/Q outputs are recombined using network shown in Figure 5. Losses of combining network not included in measurements. $V_{CC} = 5.0V$, $GND = 0V$, $P_{RF} = 0dBm$, $P_{LO} = 0dBm$, $f_{IF} = 20MHz$, $f_{LO} > f_{RF}$, intermodulation delta frequency = 1.2MHz, 50Ω LO and RF system impedance, $T_C = +25^\circ C$, unless otherwise noted.)

DEMODULATOR HIGH BAND TUNING (VARIABLE LO)

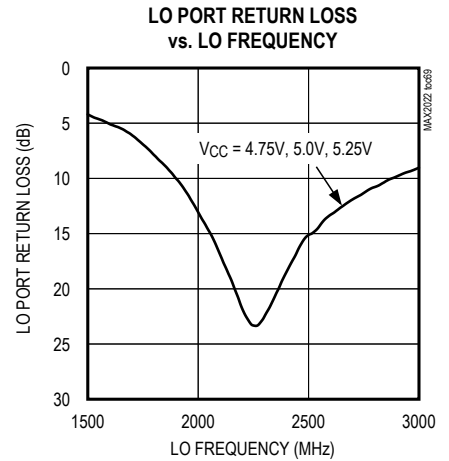
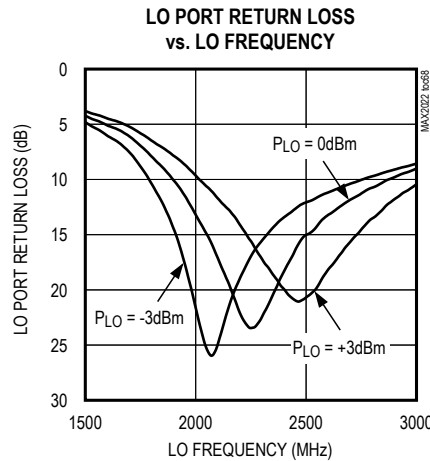
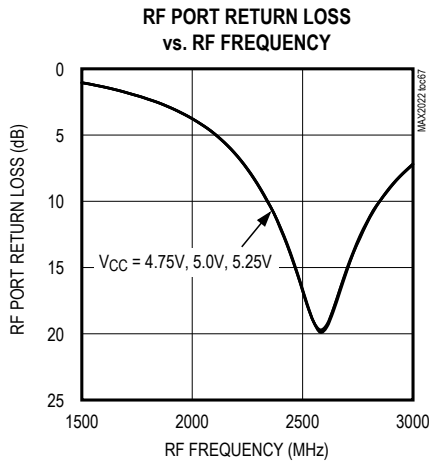
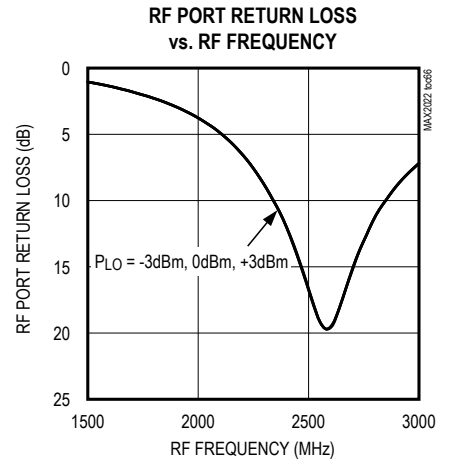
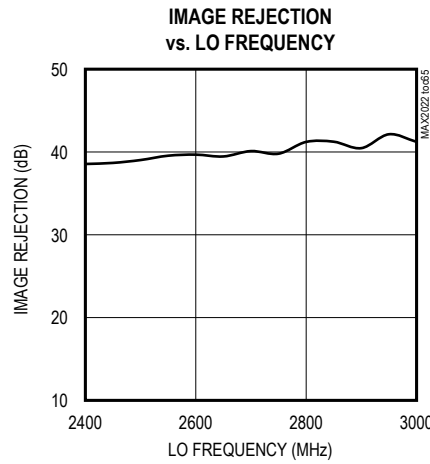
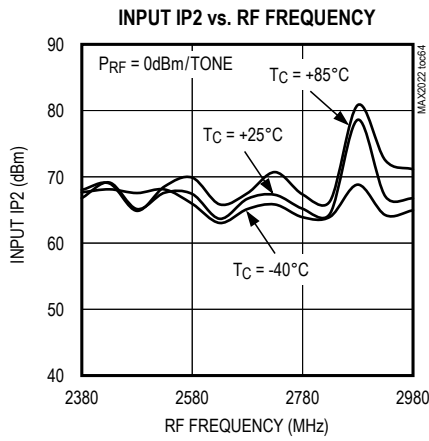

Typical Operating Characteristics (continued)

(MAX2022 *Typical Application Circuit*, RF and LO ports tuned for 2400MHz to 3000MHz as noted in [Table 1](#). I/Q outputs are recombined using network shown in [Figure 5](#). Losses of combining network not included in measurements. $V_{CC} = 5.0V$, $GND = 0V$, $P_{RF} = 0dBm$, $P_{LO} = 0dBm$, $f_{LO} = 2855MHz$, $f_{IF} = f_{LO} - f_{RF}$, intermodulation delta frequency = 1.2MHz, 50Ω LO and RF system impedance, $T_C = +25^{\circ}C$, unless otherwise noted.)

DEMODULATOR HIGH BAND TUNING (FIXED LO)

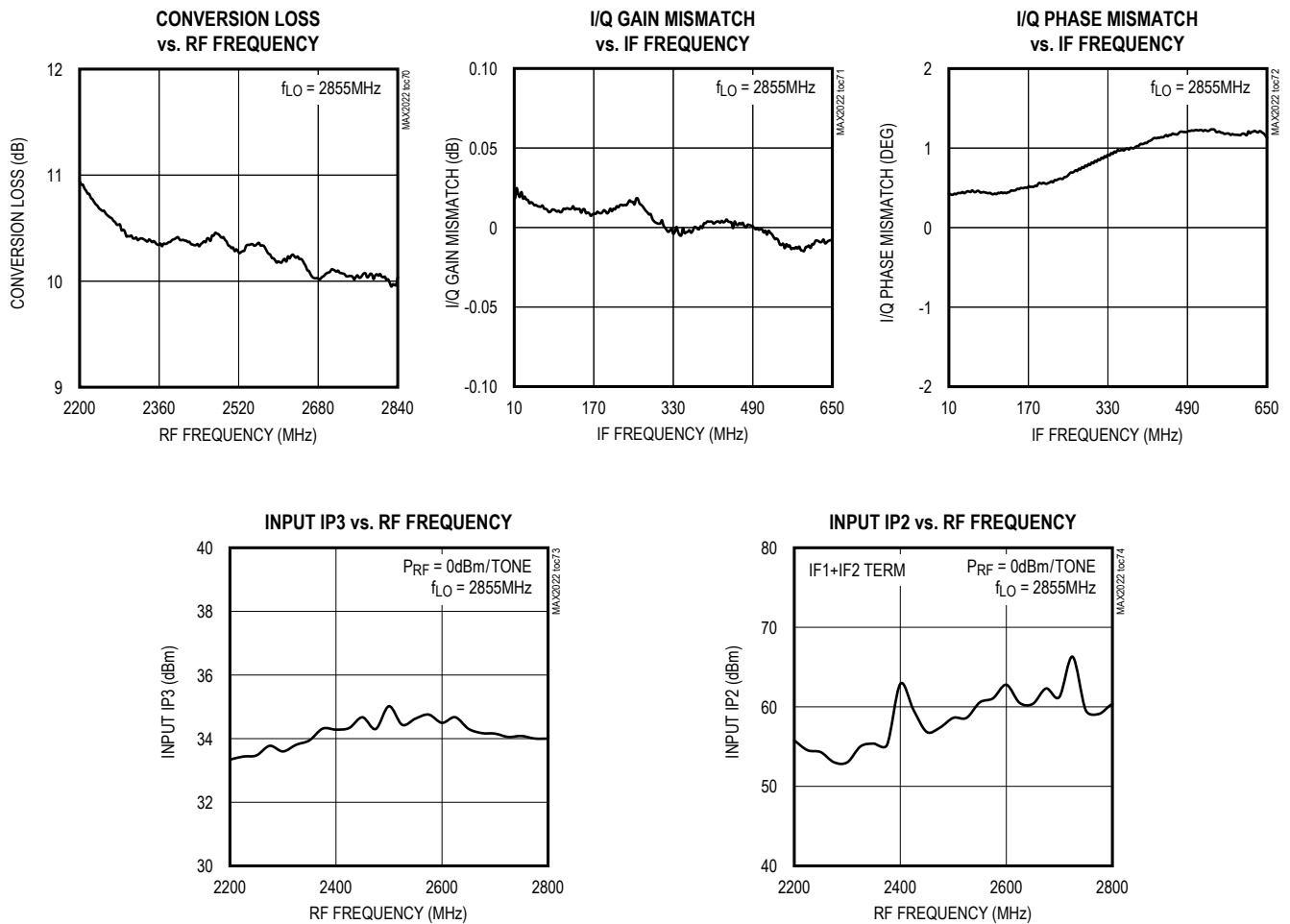

Pin Configuration/Functional Diagram

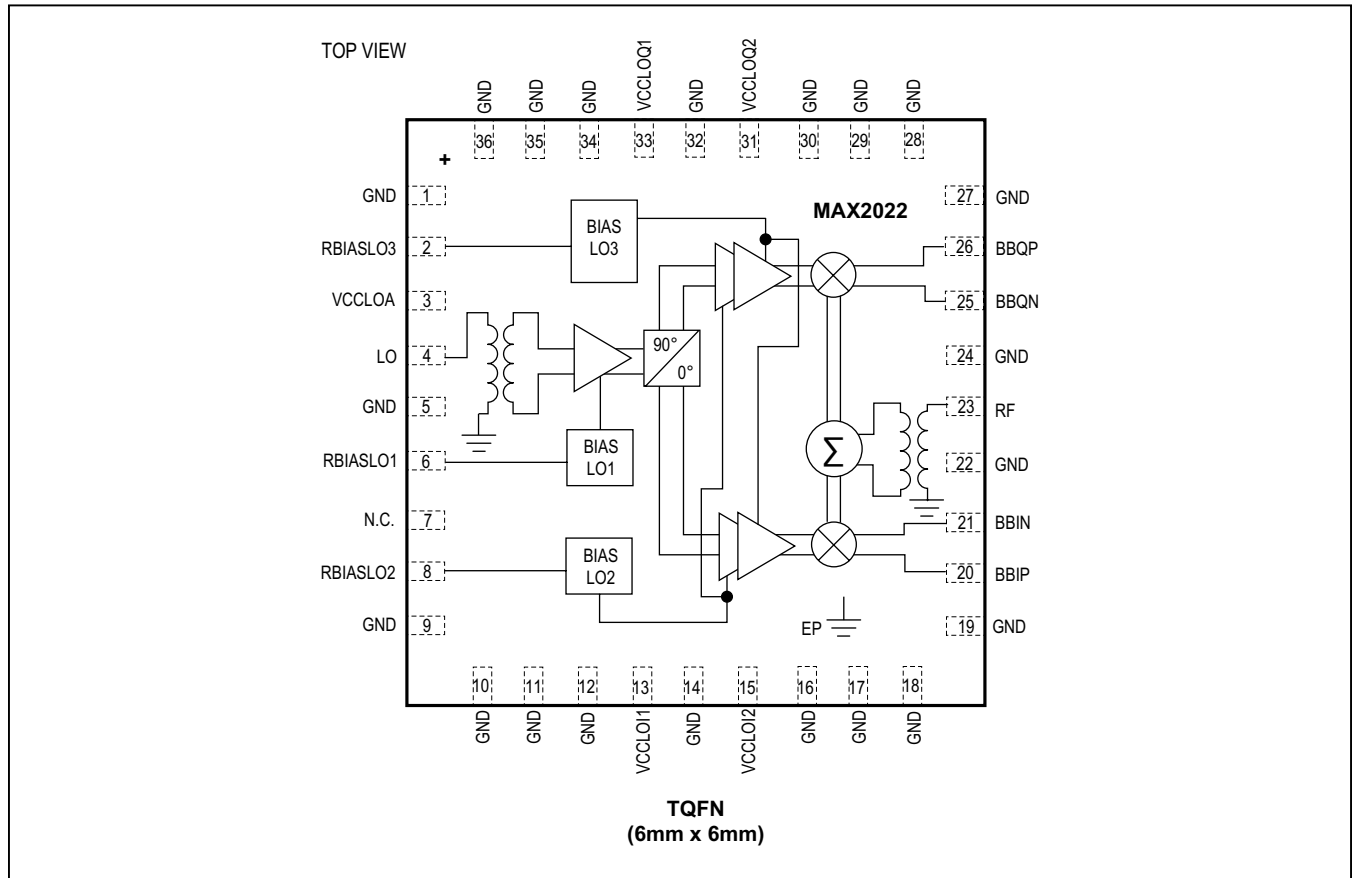

Pin Description

PIN	NAME	FUNCTION
1, 5, 9–12, 14, 16–19, 22, 24, 27–30, 32, 34, 35, 36	GND	Ground
2	RBIASLO3	3rd LO Amplifier Bias. Connect a 301Ω resistor to ground.
3	VCCLOA	LO Input Buffer Amplifier Supply Voltage
4	LO	Local Oscillator Input. 50Ω input impedance.
6	RBIASLO1	1st LO Input Buffer Amplifier Bias. Connect a 432Ω resistor to ground.
7	N.C.	No internal connection and can be connected to ground or left open.
8	RBIASLO2	2nd LO Amplifier Bias. Connect a 562Ω resistor to ground.
13	VCCLOI1	I-Channel 1st LO Amplifier Supply Voltage
15	VCCLOI2	I-Channel 2nd LO Amplifier Supply Voltage
20	BBIP	Baseband In-Phase Positive Input

Pin Description (continued)

PIN	NAME	FUNCTION
21	BBIN	Baseband In-Phase Negative Input
23	RF	RF Port
25	BBQN	Baseband Quadrature Negative Input
26	BBQP	Baseband Quadrature Positive Input
31	VCCLOQ2	Q-Channel 2nd LO Amplifier Supply Voltage
33	VCCLOQ1	Q-Channel 1st LO Amplifier Supply Voltage
—	EP	Exposed Ground Paddle. The exposed paddle MUST be soldered to the ground plane using multiple vias.

Detailed Description

The MAX2022 is designed for upconverting differential in-phase (I) and quadrature (Q) inputs from baseband to a 1500MHz to 3000MHz RF frequency range. The device can also be used as a demodulator, downconverting an RF input signal directly to baseband or an IF frequency. Applications include single and multicarrier 1500MHz to 3000MHz UMTS/WCDMA, LTE/TD-LTE, cdma2000, and DCS/PCS base stations. Direct conversion architectures are advantageous since they significantly reduce transmitter or receiver cost, part count, and power consumption as compared to traditional IF-based double-conversion systems.

The MAX2022 integrates internal baluns, an LO buffer, a phase splitter, two LO driver amplifiers, two matched double-balanced passive mixers, and a wideband quadrature combiner. Precision matching between the in-phase and quadrature channels, and highly linear mixers achieves excellent dynamic range, ACLR, 1dB compression point, and LO and sideband suppression, making it ideal for four-carrier WCDMA/UMTS operation.

LO Input Balun, LO Buffer, and Phase Splitter

The MAX2022 requires a single-ended LO input, with a nominal power of 0dBm. An internal low-loss balun at the LO input converts the single-ended LO signal to a differential signal at the LO buffer input. In addition, the internal balun matches the buffer's input impedance to 50Ω over the entire band of operation.

The output of the LO buffer goes through a phase splitter, which generates a second LO signal that is shifted by 90° with respect to the original. The 0° and 90° LO signals drive the I and Q mixers, respectively.

LO Driver

Following the phase splitter, the 0° and 90° LO signals are each amplified by a two-stage amplifier to drive the I and Q mixers. The amplifier boosts the level of the LO signals to compensate for any changes in LO drive levels. The two-stage LO amplifier allows a wide input power range for the LO drive. While a nominal LO power of 0dBm is specified, the MAX2022 can tolerate LO level swings from -3dBm to +3dBm.

I/Q Modulator

The MAX2022 modulator is composed of a pair of matched double-balanced passive mixers and a balun. The I and Q differential baseband inputs accept signals from DC to beyond 500MHz with differential amplitudes up to 2V_{P-P} differential (common-mode input equals 0V). The wide input bandwidth allows for direct interface with the baseband DACs. No active buffer circuitry between the baseband DAC and the MAX2022 is required.

The I and Q signals directly modulate the 0° and 90° LO signals and are upconverted to the RF frequency. The outputs of the I and Q mixers are combined through a balun to a singled-ended RF output.

Applications Information

LO Input Drive

The LO input of the MAX2022 requires a single-ended drive at a 1500MHz to 3000MHz frequency. It is internally matched to 50Ω. An integrated balun converts the single-ended input signal to a differential signal at the LO buffer differential input. An external DC-blocking capacitor is the only external part required at this interface. The LO input power should be within the -3dBm to +3dBm range.

High-Dynamic-Range, Direct Up/Downconversion 1500MHz to 3000MHz Quadrature Modulator/Demodulator

Modulator Baseband I/Q Input Drive

The MAX2022 I and Q baseband inputs should be driven differentially for best performance. The baseband inputs have a 50Ω differential input impedance. The optimum source impedance for the I and Q inputs is 100Ω differential. This source impedance will achieve the optimal signal transfer to the I and Q inputs, and the optimum output RF impedance match. The MAX2022 can accept input power levels of up to +12dBm on the I and Q inputs. Operation with complex waveforms, such as CDMA or WCDMA carriers, utilize input power levels that are far lower. This lower power operation is made necessary by the high peak-to-average ratios of these complex waveforms. The peak signals must be kept below the compression level of the MAX2022. The input common-mode voltage should be confined to the -2V to +1.5V DC range.

The MAX2022 is designed to interface directly with Maxim high-speed DACs. This generates an ideal total transmitter lineup, with minimal ancillary circuit elements. Such DACs include the MAX5875 series of dual DACs, and the MAX5895 dual interpolating DAC. These DACs have ground-referenced differential current outputs. Typical termination of each DAC output into a 50Ω load resistor to ground, and a 10mA nominal DC output current results in a 0.5V common-mode DC level into the modulator I/Q inputs. The nominal signal level provided by the DACs will

be in the -12dBm range for a single CDMA or WCDMA carrier, reducing to -18dBm per carrier for a four-carrier application.

The I/Q input bandwidth is greater than 50MHz at -0.1dB response. The direct connection of the DAC to the MAX2022 insures the maximum signal fidelity, with no performance-limiting baseband amplifiers required. The DAC output can be passed through a lowpass filter to remove the image frequencies from the DAC's output response. The MAX5895 dual interpolating DAC can be operated at interpolation rates up to x8. This has the benefit of moving the DAC image frequencies to a very high, remote frequency, easing the design of the baseband filters. The DAC's output noise floor and interpolation filter stopband attenuation are sufficiently good to insure that the 3GPP noise floor requirement is met for large frequency offsets, 60MHz for example, with no filtering required on the RF output of the modulator.

Figure 1 illustrates the ease and efficiency of interfacing the MAX2022 with a Maxim DAC, in this case the MAX5895 dual 16-bit interpolating-modulating DAC.

The MAX5895 DAC has programmable gain and differential offset controls built in. These can be used to optimize the LO leakage and sideband suppression of the MAX2022 quadrature modulator.

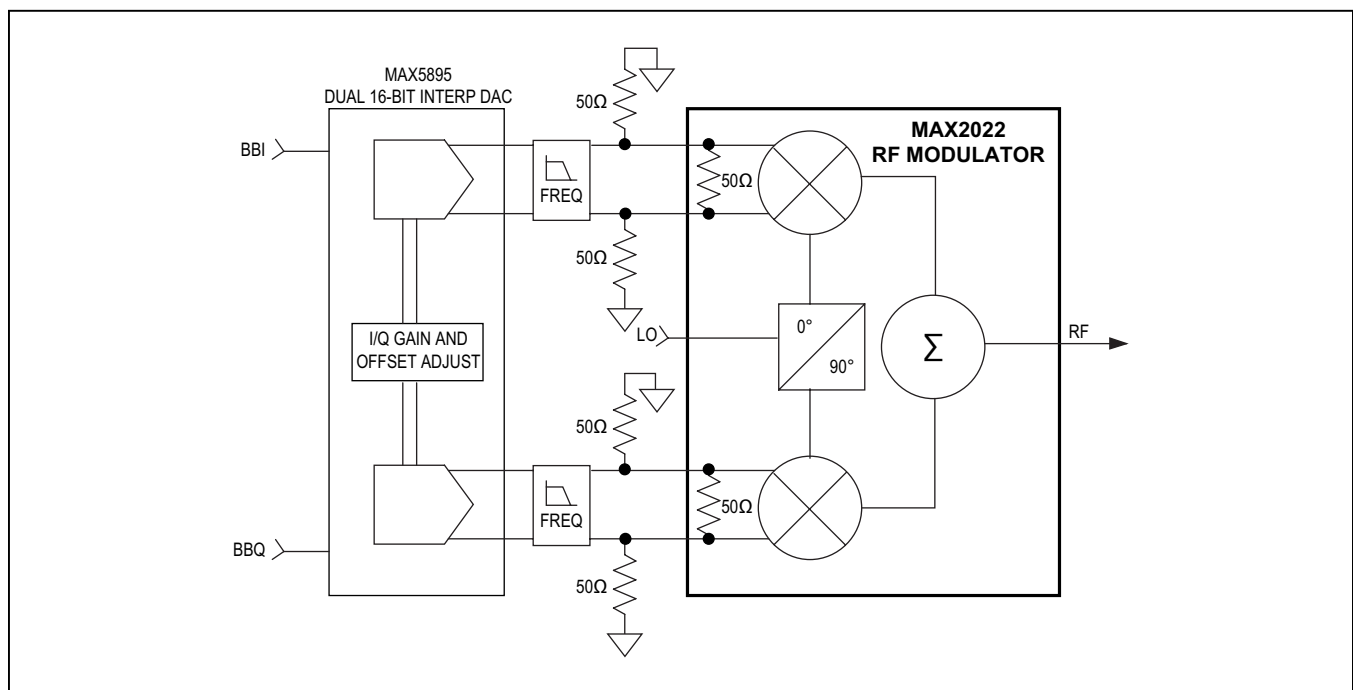

Figure 1. MAX5895 DAC Interfaced with MAX2022

RF Output

The MAX2022 utilizes an internal passive mixer architecture. This enables a very low noise floor of -173.2dBm/Hz for low-level signals, below about -20dBm output power level. For higher output level signals, the noise floor will be determined by the internal LO noise level at approximately -162dBc/Hz.

The I/Q input power levels and the insertion loss of the device will determine the RF output power level. The input power is the function of the delivered input I and Q voltages to the internal 50Ω termination. For simple sinusoidal baseband signals, a level of 89mV_{P-P} differential on the I and the Q inputs results in an input power level of -17dBm delivered to the I and Q internal 50Ω terminations. This results in a -23.5dBm RF output power.

Generation of WCDMA Carriers

The MAX2022 quadrature modulator makes an ideal signal source for the generation of multiple WCDMA carriers. The combination of high OIP3 and exceptionally low output noise floor gives an unprecedented output dynamic range. The output dynamic range allows the generation of four WCDMA carriers in the UMTS band with a noise floor sufficiently low to meet the 3GPP specification requirements with no additional RF filtering. This promotes an extremely simple and efficient transmitter lineup. [Figure 2](#)

illustrates a complete transmitter lineup for a multicarrier WCDMA transmitter in the UMTS band.

The MAX5895 dual interpolating-modulating DAC is operated as a baseband signal generator. For generation of four carriers of WCDMA modulation, and digital predistortion, an input data rate of 61.44 or 122.88Mbps can be used. The DAC can then be programmed to operate in x8 or x4 interpolation mode, resulting in a 491.52MSPS output sample rate. The DAC will generate four carriers of WCDMA modulation with an ACLR typically greater than 77dB under these conditions. The output power will be approximately -18dBm per carrier, with a noise floor typically less than -144dBc/Hz.

The MAX5895 DAC has built-in gain and offset fine adjustments. These are programmable by a 3-wire serial logic interface. The gain adjustment can be used to adjust the relative gains of the I and Q DAC outputs. This feature can be used to improve the native sideband suppression of the MAX2022 quadrature modulator. The gain adjustment resolution of 0.01dB allows sideband nulling down to approximately -60dB. The offset adjustment can similarly be used to adjust the offset DC output of each I and Q DAC. These offsets can then be used to improve the native LO leakage of the MAX2022. The DAC resolution of 4 LSBs will yield nulled LO leakage of typically less than -50dBc relative to four-carrier output levels.

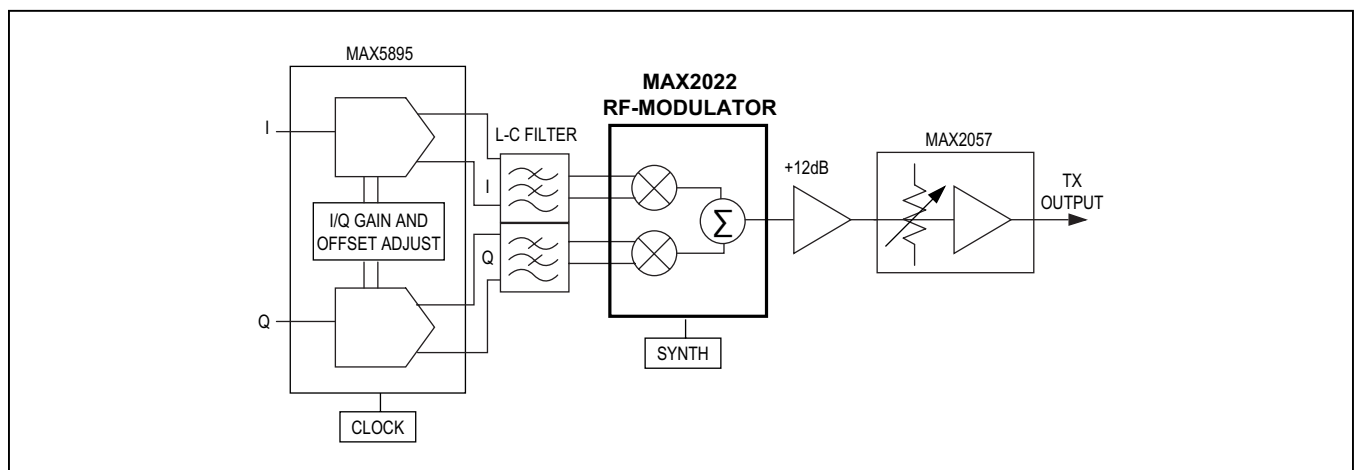

Figure 2. Complete Transmitter Lineup for a Multicarrier WCDMA in the UMTS Band

MAX2022

High-Dynamic-Range, Direct Up/Downconversion 1500MHz to 3000MHz Quadrature Modulator/Demodulator

The DAC outputs must be filtered by baseband filters to remove the image frequency signal components. The baseband signals for four-carrier operation cover DC to 10MHz. The image frequency appears at 481MHz to 491MHz. This very large frequency spread allows the use of very low-complexity lowpass filters, with excellent in-band gain and phase performance. The low DAC noise floor allows for the use of a very wideband filter, since the filter is not necessary to meet the 3GPP noise floor specification.

The MAX2022 quadrature modulator then upconverts the baseband signals to the RF output frequency. The output power of the MAX2022 will be approximately -28dBm per carrier. The noise floor will be less than -169dBm/Hz, with an ACLR typically greater than 65dBc. This performance meets the 3GPP specification requirements with substantial margins. The noise floor performance will be maintained for large offset frequencies, eliminating the need for subsequent RF filtering in the transmitter lineup.

The RF output from the MAX2022 is then amplified by a combination of a low-noise amplifier followed by a MAX2057 RF-VGA. This VGA can be used for lineup compensation for gain variance of transmitter and power amplifier elements. No significant degradation of the signal or noise levels will be incurred by this additional amplification. The MAX2057 will deliver an output power of -6dBm per carrier, 0dBm total at an ACLR of 65dB and noise floor of -142dBc/Hz.

External Diplexer

LO leakage at the RF port can be nulled to a level less than -80dBm by introducing DC offsets at the I and Q ports. However, this null at the RF port can be compromised by an improperly terminated I/Q interface. Care must be taken to match the I/Q ports to the external circuitry. Without matching, the LO's second-order term ($2f_{LO}$) it may reflect back into the modulator's I/Q ports where it can remix with the internal LO signal to produce additional LO leakage at the RF output. This reflection effectively counteracts against the LO nulling. In addition, the LO signal reflected at the I/Q IF port produces a residual DC term that can disturb the nulling condition.

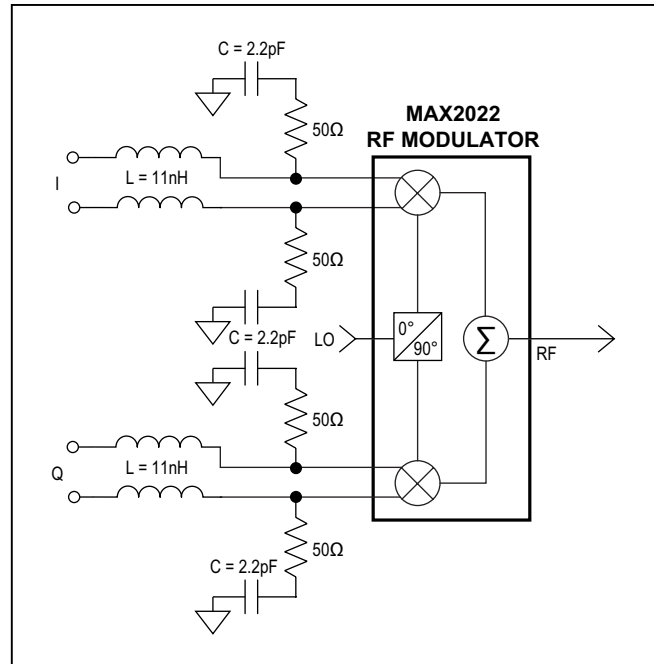

Figure 3. Diplexer Network Recommended for UMTS Transmitter Applications

As demonstrated in [Figure 3](#), providing an RC termination on each of the I+, I-, Q+, Q- ports reduces the amount of LO leakage present at the RF port under varying temperature, LO frequency, and baseband termination conditions. See the [Typical Operating Characteristics](#) for details. Note that the resistor value is chosen to be 50Ω with a corner frequency $1 / (2\pi RC)$ selected to adequately filter the f_{LO} and $2f_{LO}$ leakage, yet not affecting the flatness of the baseband response at the highest baseband frequency. The common-mode f_{LO} and $2f_{LO}$ signals at I+/I- and Q+/Q- effectively see the RC networks and thus become terminated in 25Ω ($R/2$). The RC network provides a path for absorbing the $2f_{LO}$ and f_{LO} leakage, while the inductor provides high impedance at f_{LO} and $2f_{LO}$ to help the diplexing process.

RF Demodulator

The MAX2022 can also be used as an RF demodulator (see Figure 4), downconverting an RF input signal directly to baseband. The single-ended RF input accepts signals from 1500MHz to 3000MHz. The passive mixer architecture produces a conversion loss of typically 9.2dB and a noise figure of 9.4dB. The downconverter is optimized for high linearity of typically +39dBm IIP3. A wide I/Q port bandwidth allows the port to be used as an image-reject mixer for downconversion to a quadrature IF frequency.

The RF and LO inputs are internally matched to 50Ω. Thus, no matching components are required, and only DC-blocking capacitors are needed for interfacing.

Demodulator Output Port Considerations

Much like in the modulator case, the four baseband ports require some form of DC return to establish a common mode that the on-chip circuitry drives. This is achieved by directly DC-coupling to the baseband ports (staying

within the -2.5V to +1.5V common-mode range), through an inductor to ground, or through a low-value resistor to ground. Figure 6 shows a typical network that would be used to connect to each baseband port for demodulator operation. This network provides a common-mode DC return, implements a high-frequency diplexer to terminate unwanted RF terms, and also provides an impedance transformation to a possible higher impedance baseband amplifier.

The network C_a , R_a , L_a , and C_b form a highpass/lowpass network to terminate the high frequencies into a load while passing the desired lower IF frequencies. Elements L_a , C_b , L_b , C_c , L_c , and C_d provide a possible impedance transformer. Depending on the impedance being transformed and the desired bandwidth, a fewer number of elements can be used. It is suggested that L_a and C_b always be used since they are part of the high-frequency diplexer. If power matching is not a concern, then this reduces the elements to just the diplexer.

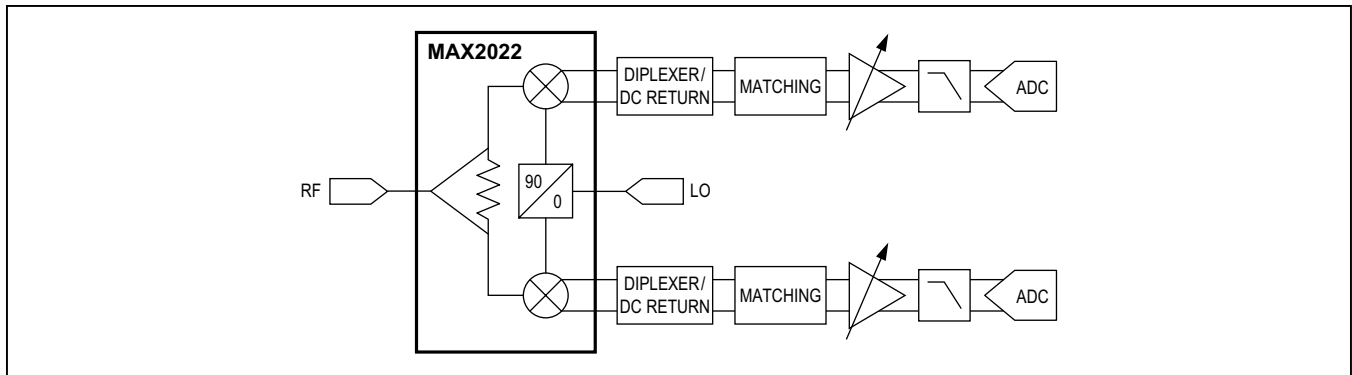

Figure 4. MAX2022 Demodulator Configuration

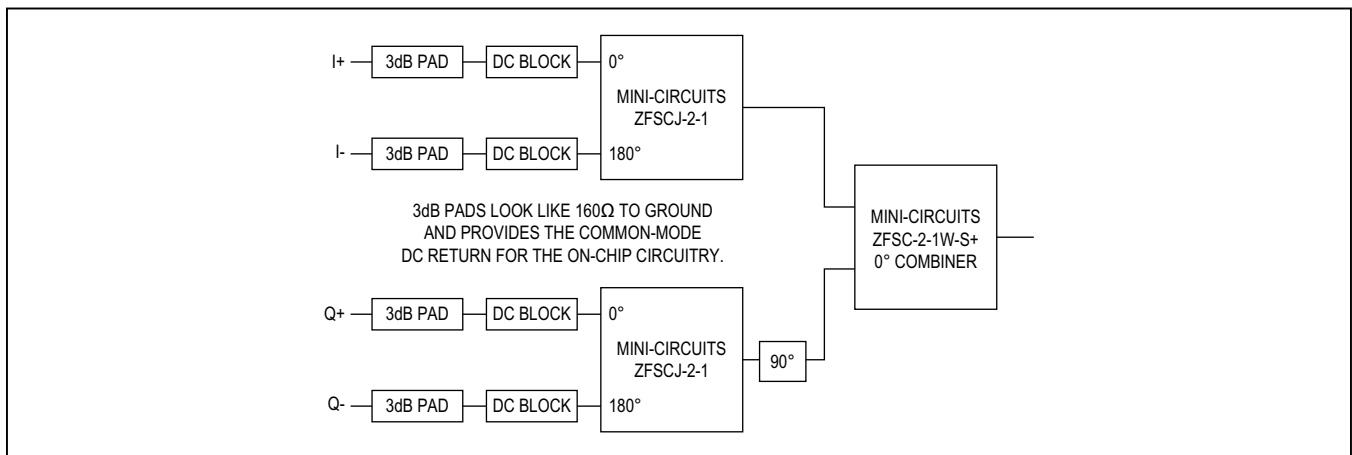

Figure 5. Demodulator Combining Diagram

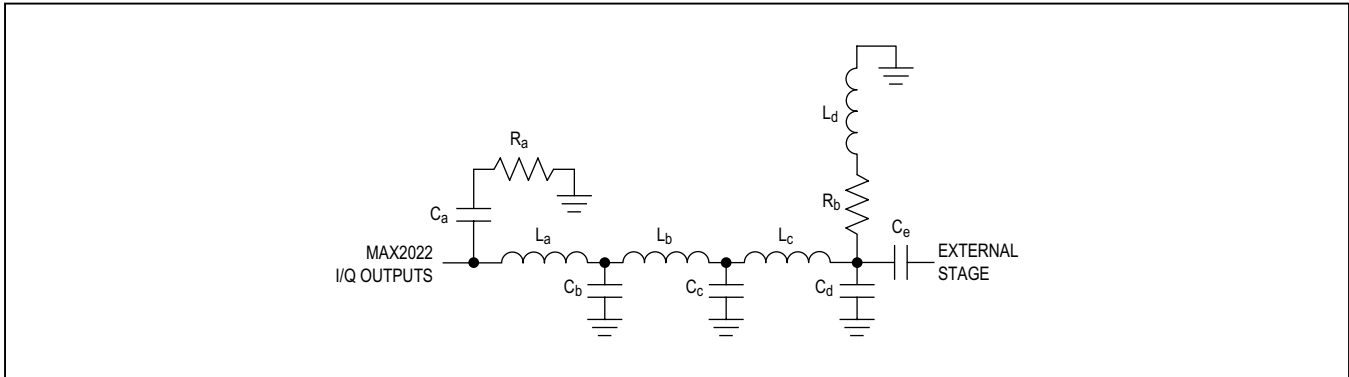

Figure 6. Baseband Port Typical Filtering and DC Return Network

Resistor R_b provides a DC return to set the common-mode voltage. In this case, due to the on-chip circuitry, the voltage is approximately 0V DC. It can also be used to reduce the load impedance of the next stage. Inductor L_d can provide a bit of high-frequency gain peaking for wideband IF systems. Capacitor C_e is a DC block.

Typical values for C_a , R_a , L_a , and C_b would be 1.5pF, 50Ω, 11nH, and 4.7pF, respectively. These values can change depending on the LO, RF, and IF frequencies used. Resistor R_b is in the 50Ω to 200Ω range.

The circuitry presented in [Figure 6](#) does not allow for LO leakage at RF port nulling. Depending on the LO at RF leakage requirement, a trim voltage may need to be introduced on the baseband ports to null the LO leakage.

Power Scaling with Changes to the Bias Resistors

Bias currents for the LO buffers are optimized by fine tuning resistors R1, R2, and R3. Maxim recommends using ±1%-tolerance resistors; however, standard ±5% values can be used if the ±1% components are not readily available. The resistor values shown in the [Typical Application Circuit](#) were chosen to provide peak performance for the entire 1500MHz to 3000MHz band. If desired, the current can be backed off from this nominal value by choosing different values for R1, R2, and R3. Contact the factory for additional details.

Layout Considerations

A properly designed PCB is an essential part of any RF/microwave circuit. Keep RF signal lines as short as possible to reduce losses, radiation, and inductance. For the best performance, route the ground pin traces directly to the exposed pad under the package. The PCB exposed paddle **MUST** be connected to the ground plane of the PCB. It is suggested that

multiple vias be used to connect this pad to the lower-level ground planes. This method provides a good RF/thermal conduction path for the device. Solder the exposed pad on the bottom of the device package to the PCB. The MAX2022 evaluation kit can be used as a reference for board layout. Gerber files are available upon request at www.maximintegrated.com.

Power-Supply Bypassing

Proper voltage-supply bypassing is essential for high-frequency circuit stability. Bypass all V_{CC} pins with 22pF and 0.1μF capacitors placed as close to the pins as possible. The smallest capacitor should be placed closest to the device.

To achieve optimum performance, use good voltage-supply layout techniques. The MAX2022 has several RF processing stages that use the various V_{CC} pins, and while they have on-chip decoupling, off-chip interaction between them may degrade gain, linearity, carrier suppression, and output power-control range. Excessive coupling between stages may degrade stability.

Exposed Pad RF/Thermal Considerations

The EP of the MAX2022's 36-pin thin QFN-EP package provides a low thermal-resistance path to the die. It is important that the PCB on which the IC is mounted be designed to conduct heat from this contact. In addition, the EP provides a low-inductance RF ground path for the device.

The exposed paddle (EP) **MUST** be soldered to a ground plane on the PCB either directly or through an array of plated via holes. An array of 9 vias, in a 3 x 3 array, is suggested. Soldering the pad to ground is critical for efficient heat transfer. Use a solid ground plane wherever possible.

Table 1. Component List Referring to the [Typical Application Circuit](#)

COMPONENT	VALUE	DESCRIPTION
C1, C6, C7, C10, C13	22pF	22pF $\pm 5\%$, 50V C0G ceramic capacitors (0402)
C2, C5, C8, C11, C12	0.1 μ F	0.1 μ F $\pm 10\%$, 16V X7R ceramic capacitors (0603)
C3	22pF	22pF $\pm 5\%$, 50V C0G ceramic capacitor (0402), $f_{LO} = 1500\text{MHz to } 2400\text{MHz}$
	6.8pF	6.8pF $\pm 5\%$, 50V C0G ceramic capacitor (0402), $f_{LO} = 2400\text{MHz to } 3000\text{MHz}$
C9	1.2pF	1.2pF $\pm 0.1\text{pF}$, 50V C0G ceramic capacitor (0402), $f_{RF} = 1500\text{MHz to } 2400\text{MHz}$
	22pF	22pF $\pm 5\%$, 50V C0G ceramic capacitor (0402), $f_{RF} = 2400\text{MHz to } 3000\text{MHz}$
C16	Short	Replace with a short circuit or 0 Ω resistor (0402), $f_{RF} = 1500\text{MHz to } 2400\text{MHz}$
	0.7pF	0.7pF $\pm 0.1\text{pF}$, 50V C0G ceramic capacitor (0402), $f_{RF} = 2400\text{MHz to } 3000\text{MHz}$
L1	Not Used	Not installed for $f_{RF} = 1500\text{MHz to } 2400\text{MHz}$
	4.7nH	4.7nH $\pm 0.3\text{nH}$ inductor (0402) for $f_{RF} = 2400\text{MHz to } 3000\text{MHz}$
R1	432 Ω	432 Ω $\pm 1\%$ resistor (0402)
R2	562 Ω	562 Ω $\pm 1\%$ resistor (0402)
R3	301 Ω	301 Ω $\pm 1\%$ resistor (0402)

Ordering Information

PART	TEMP RANGE	PIN-PACKAGE
MAX2022ETX+	-40°C to +85°C	36 TQFN-EP*
MAX2022ETX+T	-40°C to +85°C	36 TQFN-EP*

+Denotes a lead(Pb)-free/RoHS-compliant package.

T = Tape and reel.

*EP = Exposed pad.

Chip Information

PROCESS: SiGe BiCMOS

Package Information

For the latest package outline information and land patterns (footprints), go to www.maximintegrated.com/packages. Note that a "+", "#", or "-" in the package code indicates RoHS status only. Package drawings may show a different suffix character, but the drawing pertains to the package regardless of RoHS status.

PACKAGE TYPE	PACKAGE CODE	OUTLINE NO.	LAND PATTERN NO.
TQFN-EP (6mm x 6mm)	T3666+2	21-0141	90-0049

Typical Application Circuit

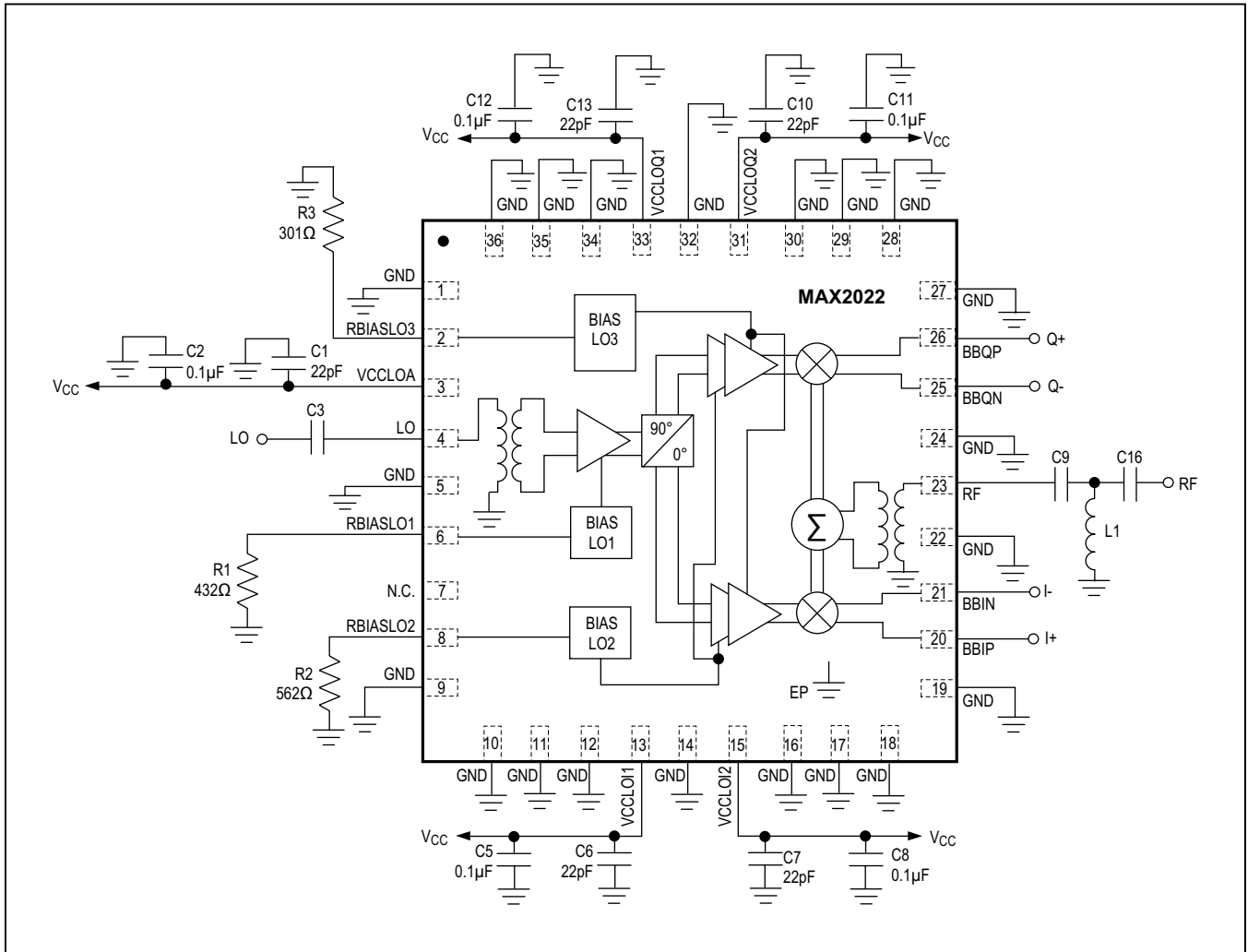

Revision History

REVISION NUMBER	REVISION DATE	DESCRIPTION	PAGES CHANGED
0	4/05	Initial release	—
1	9/12	Updated the <i>Benefits and Features</i> , <i>Applications</i> , <i>Absolute Maximum Ratings</i> , and <i>Ordering Information</i> ; added new electrical characteristics tables, figures, and sections	1–19
2	3/13	Corrected pin 15 name from VCCL01 to VCCL02 in the <i>Pin Configuration/Functional Diagram</i> and <i>Pin Description</i>	11, 12
3	7/13	Added new TOCs 46–74	12–16

For pricing, delivery, and ordering information, please contact Maxim Direct at 1-888-629-4642, or visit Maxim Integrated's website at www.maximintegrated.com.

Maxim Integrated cannot assume responsibility for use of any circuitry other than circuitry entirely embodied in a Maxim Integrated product. No circuit patent licenses are implied. Maxim Integrated reserves the right to change the circuitry and specifications without notice at any time. The parametric values (min and max limits) shown in the Electrical Characteristics table are guaranteed. Other parametric values quoted in this data sheet are provided for guidance.