

SERIES: SMI24 | **DESCRIPTION:** AC-DC POWER SUPPLY

FEATURES

- up to 24 W continuous power
- DoE Level VI, CoC Tier 2 efficiency
- no load power consumption < 0.075 W
- universal input voltage range
- interchangeable Ac blades for global use
- over voltage, over current, and short circuit protections
- UL/cUL, RCM, CCC, and PSE safety approvals
- certified to 60950-1 and 62368-1 standards

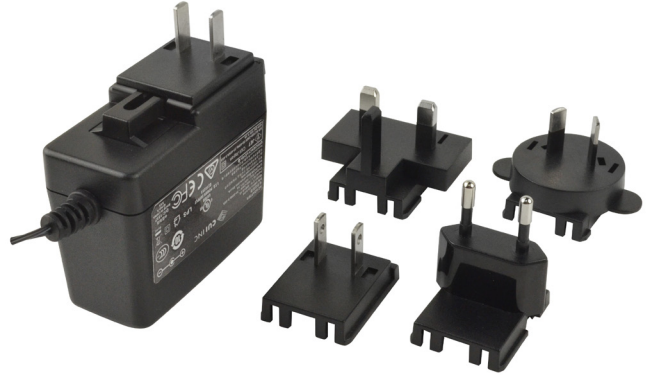

| MODEL | input voltage | input frequency | output voltage | output current | output power | ripple and noise ¹ | efficiency level ² | | no load power consumption |
|----------|---------------|-----------------|----------------|----------------|--------------|-------------------------------|-------------------------------|---------|---------------------------|
| | range (Vac) | range (Hz) | nom (Vdc) | max (A) | max (W) | max (mVp-p) | average (%) | 10% (%) | typ (W) |
| SMI24-5 | 90 ~ 264 | 47 ~ 63 | 5 | 4 | 20 | 100 | 83.8 | 80.4 | 0.07 |
| SMI24-9 | 90 ~ 264 | 47 ~ 63 | 9 | 2.5 | 22.5 | 100 | 87.0 | 83.1 | 0.06 |
| SMI24-12 | 90 ~ 264 | 47 ~ 63 | 12 | 2 | 24 | 120 | 87.2 | 84.0 | 0.07 |
| SMI24-15 | 90 ~ 264 | 47 ~ 63 | 15 | 1.6 | 24 | 150 | 88.1 | 84.4 | 0.06 |
| SMI24-24 | 90 ~ 264 | 47 ~ 63 | 24 | 1 | 24 | 240 | 88.8 | 82.6 | 0.07 |
| SMI24-48 | 90 ~ 264 | 47 ~ 63 | 48 | 0.5 | 24 | 480 | 88.2 | 79.1 | 0.07 |

Notes: 1. At full load, nominal input, 20 MHz bandwidth oscilloscope, each output terminated with 0.1 µF multilayer ceramic and 10 µF low ESR electrolytic capacitors.
2. CoC Tier 2 compliant

PART NUMBER KEY

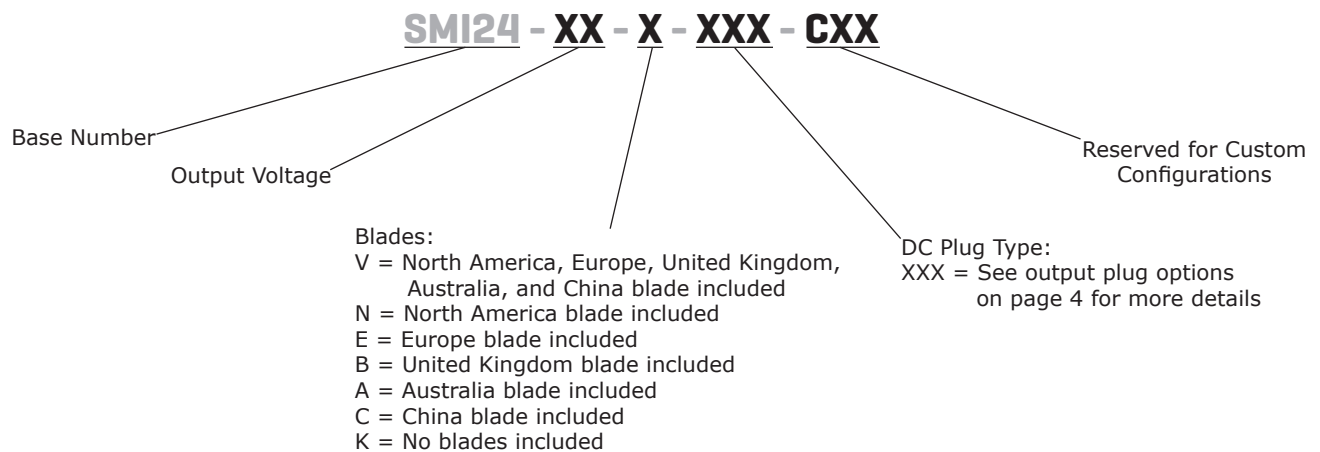

INPUT

| parameter | conditions/description | min | typ | max | units |
|---------------------------|--|-----|-----|----------|--------|
| voltage | | 90 | | 264 | Vac |
| frequency | | 47 | | 63 | Hz |
| current | | | | 0.58 | A |
| inrush current | at 100 Vac, full load, 25°C, cold start at 230 Vac, full load, 25°C, cold start | | | 50 60 | A A |
| leakage current | | | | 0.25 | mA |
| no load power consumption | at 230 Vac | | | 0.075 | W |

OUTPUT

| parameter | conditions/description | min | typ | max | units |
|--------------|--|-----|----------|-----|--------|
| regulation | 5 Vdc output model all other models | | ±6 ±5 | | % % |
| hold-up time | at full load | 10 | | | ms |

PROTECTIONS

| parameter | conditions/description | min | typ | max | units |
|--------------------------|---------------------------------|-----|-----|-----|-------|
| over voltage protection | output shut down | | | | |
| | 5 Vdc output model | | | 12 | Vdc |
| | 9 Vdc output model | | | 16 | Vdc |
| | 12 Vdc output model | | | 22 | Vdc |
| | 15 Vdc output model | | | 32 | Vdc |
| | 24 Vdc output model | | | 45 | Vdc |
| over current protection | 48 Vdc output model | | | 75 | Vdc |
| | output shut down, auto recovery | | | | |
| | 5 Vdc output model | | | 8 | A |
| | 9 Vdc output model | | | 5 | A |
| | 12 Vdc output model | | | 5 | A |
| | 15 Vdc output model | | | 4 | A |
| short circuit protection | 24 Vdc output model | | | 2.5 | A |
| | 48 Vdc output model | | | 1.2 | A |
| | output shut down, auto recovery | | | | |

SAFETY & COMPLIANCE

| parameter | conditions/description | min | typ | max | units |
|----------------------|--|---------|-------|-----|-------|
| isolation voltage | input to output at 10 mA for 1 minute | | 3,000 | | Vac |
| isolation resistance | input to output at 500 Vdc | 10 | | | MΩ |
| safety approvals | UL/cUL (60950-1, 62368-1), RCM, CCC, PSE, UKCA | | | | |
| EMI/EMC | FCC Part 15B Class B, CE | | | | |
| MTBF | as per Telcordia SR-332, 25°C | 300,000 | | | hours |
| RoHS | yes | | | | |

ENVIRONMENTAL

| parameter | conditions/description | min | typ | max | units |
|-----------------------|------------------------|-----|-----|-----|-------|
| operating temperature | | 0 | | 40 | °C |
| storage temperature | | -20 | | 80 | °C |
| operating humidity | non-condensing | 20 | | 80 | % |
| storage humidity | non-condensing | 10 | | 90 | % |

MECHANICAL

| parameter | conditions/description | min | typ | max | units |
|--------------------|--|-----|-----|-----|-------|
| dimensions | 75 x 35.8 x 65.6 | | | | mm |
| inlet plug | interchangeable blades (North America, Europe, UK, Australia, China) | | | | |
| ac blade clip type | pinch clip | | | | |
| weight | without blades | | 170 | | g |

MECHANICAL DRAWING

units: mm
tolerance: ±1.0 mm

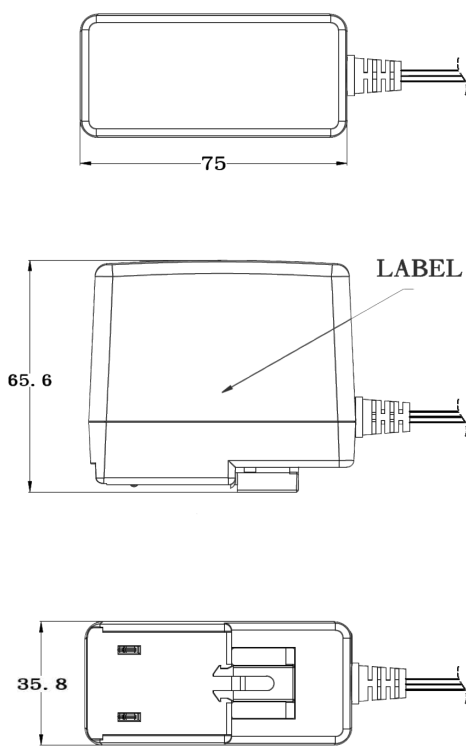

| INTERCHANGEABLE BLADES | | | | | |
|------------------------|---------------|----------------|------------|-------------------|---------------|
| BLADE DESIGNATOR | N | E | B | A | C |
| REGION | North America | Europe | UK | Australia | China |
| BLADE ACCESSORY | SMI-US-2 | SMI-EU-2 | SMI-UK-2 | SMI-AU-2 | SMI-CN-2 |
| BLADE | US (N) | Europe (E) | UK (B) | Australia (A) | China (C) |

DC CORD

units: mm

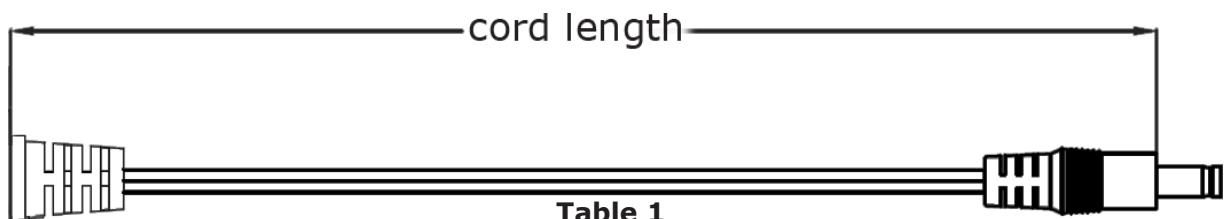

Table 1

| MODEL NO. | CABLE | CORD LENGTH |
|-----------|----------------|--------------|
| SMI24-5 | UL2468, 18 AWG | 1,000 mm ±30 |
| SMI24-9 | UL2468, 18 AWG | 1,500 mm ±30 |
| SMI24-12 | UL2468, 20 AWG | 1,500 mm ±30 |
| SMI24-15 | UL2468, 20 AWG | 1,500 mm ±30 |
| SMI24-24 | UL2468, 22 AWG | 1,500 mm ±30 |
| SMI24-48 | UL2468, 22 AWG | 1,500 mm ±30 |

DC PLUG TYPE PART NUMBER KEY

XXX

Plug Polarity:
P = Center Positive

N = Center Negative

Plug Code:
X = Choose a code from the options below

Plug Angle:
"blank" = Straight
R = Right Angle

| Plug Polarity | | Code | | Dimensions (mm) | | | Plug Angle | |
|---------------|-------------|--------|----------------------|-----------------|------|-----|------------|-------|
| Center Pos. | Center Neg. | Option | Type | A | B | C | Straight | Right |
| • | • | 5 | Standard | 5.5 | 2.1 | 9.5 | • | • |
| • | • | 6 | Standard | 5.5 | 2.5 | 9.5 | • | • |
| • | • | 7 | Standard | 3.5 | 1.35 | 9.5 | • | • |
| • | • | 8 | Standard | 3.8 | 1.35 | 9.5 | • | • |
| • | • | 9 | Standard | 3.8 | 1.05 | 9.5 | • | • |
| • | • | 10 | Locking ² | 5.5 | 2.1 | 9.5 | • | N/A |
| • | • | 11 | Locking ² | 5.5 | 2.5 | 9.5 | • | N/A |
| • | • | 12 | EIAJ-1 | 2.35 | 0.7 | 9.5 | • | • |
| • | • | 13 | EIAJ-2 | 4.0 | 1.7 | 9.5 | • | • |
| • | • | 14 | EIAJ-3 | 4.75 | 1.7 | 9.5 | • | • |
| N/A | N/A | ST | Stripped & Tinned | | | N/A | N/A | N/A |

Note: 1. Contact CUI for additional plug options
2. Maximum insertion depth is 10mm

Standard

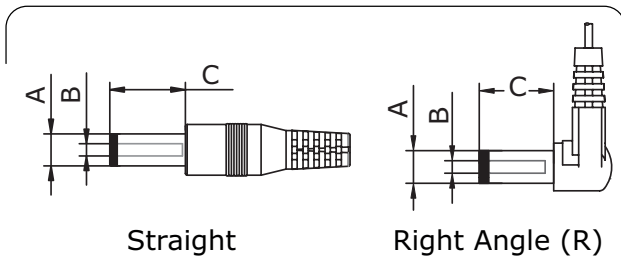

EIAJ

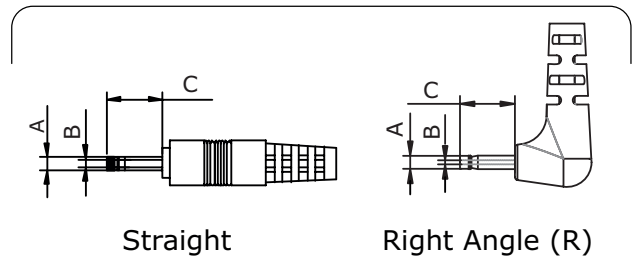

Locking

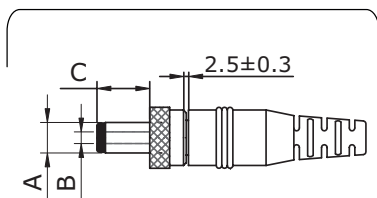

Stripped & Tinned

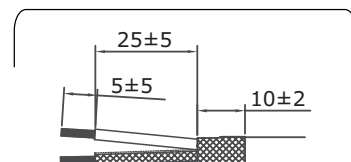

REVISION HISTORY

| rev. | description | date |
|------|----------------------------------|------------|
| 1.0 | initial release | 08/07/2015 |
| 1.01 | updated datasheet | 11/04/2015 |
| 1.02 | housing width changed to 35.8 mm | 01/27/2016 |
| 1.03 | updated datasheet | 09/15/2016 |
| 1.04 | added 62368-1 standard | 08/31/2018 |
| 1.05 | company logo updated | 09/30/2020 |
| 1.06 | model table updated | 11/27/2020 |
| 1.07 | UKCA added to specification | 08/11/2021 |
| 1.08 | plug polarity symbols updated | 09/16/2021 |
| 1.09 | dc plugs updated | 04/29/2022 |
| 1.10 | ac blade clip type added | 06/23/2022 |

The revision history provided is for informational purposes only and is believed to be accurate.



CUI INC

a bel group

Headquarters
20050 SW 112th Ave.
Tualatin, OR 97062
800.275.4899

Fax 503.612.2383
cui.com
techsupport@cui.com

This device complies with part 15 of the FCC Rules. Operation is subject to the following two conditions:

- (1) This device may not cause harmful interference, and
- (2) this device must accept any interference received, including interference that may cause undesired operation.

CUI offers a one (1) year limited warranty. Complete warranty information is listed on our website.

CUI reserves the right to make changes to the product at any time without notice. Information provided by CUI is believed to be accurate and reliable. However, no responsibility is assumed by CUI for its use, nor for any infringements of patents or other rights of third parties which may result from its use.

CUI products are not authorized or warranted for use as critical components in equipment that requires an extremely high level of reliability. A critical component is any component of a life support device or system whose failure to perform can be reasonably expected to cause the failure of the life support device or system, or to affect its safety or effectiveness.