

SMT ISOLATION TRANSFORMERS

LOW POWER ISOLATION TRANSFORMERS



Low Power Isolation Transformers are used in a wide-assortment of applications and circuits for the communications, computing, medical, industrial and automotive market segments. Traditionally isolation transformers were used to isolate signals between low voltage and high voltage circuits, provide voltage to gate drive circuitry and turn-on and control IGBTs. In addition, they are used to power isolated communication interfaces such as RS-232 and RS-485. With the proliferation of high voltage battery packs in automotive and energy storage applications the demand for compact, high isolation transformers is growing exponentially.

Isolation transformers are used primarily in energy transfer topologies such as push-pull, half-bridge or full-bridge but they are also used in energy storage topologies such as quasi resonant and discontinuous mode flybacks.

The selection of the appropriate isolation transformer will depend on:

1) End-Application Safety Requirements

- * Minimum isolation voltage to comply with the applications working voltage.
- * Level of insulation (Functional, Basic, Reinforced)
- * Minimum safety distances (creepage and clearances)

2) End-Application Electrical Requirements

- * Selected Topology
- * Input and Output Voltages which will dictate the turns ratio
- * Operating Frequency which, along with the input voltage will set the volt-usecs
- * Output power to ensure the selected component is sized correctly

Pulse parts are designed to be UL and TUV compliant where indicated in accordance the IEC60950, IEC61558, IEC60601 safety standards.

Selected designs have also been safety standard certified.

Pulse offers both commercial and automotive grade parts.



High Side, Low Side H-Bridge

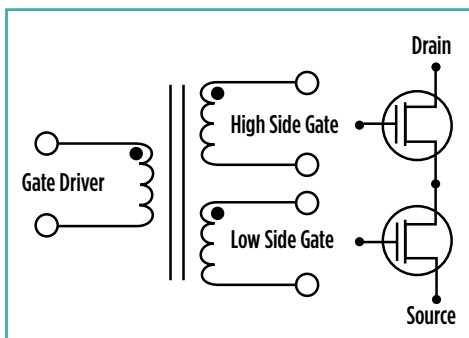



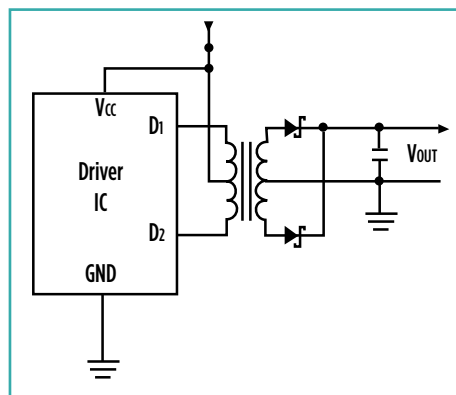

Push-pull Isolation Transformer

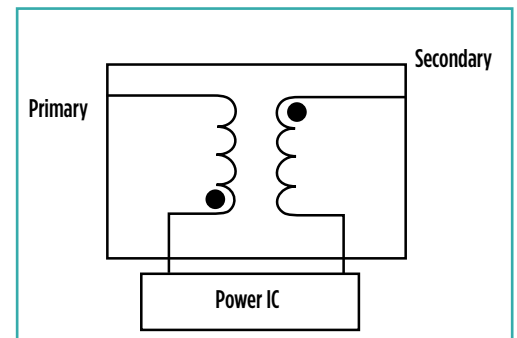

Flyback Isolation Transformer



SMT Isolation Transformer Solutions

	Dimensions			Series	Isolation	Insulation	UL Creepage	Volt-usec Rating (V-usec)	Topology	IATF
	L	W	H							
	6.6	5.8	5.3	PH9084	1500Vrms	Functional	-	28-37	Energy Transfer (schematic 1)	-
	7.1	6.1	5.5	PA2777	1500Vrms	Basic	1.4mm	9.3	Energy Transfer (schematic 4)	-
	8.0	6.6	5.3	P0926	1500Vdc	Functional	-	23	Energy Transfer (schematic 2)	-
	8.3	6.9	3.0	PG1427	2700Vdc	Functional	-	21-30	Energy Transfer (schematic 3)	-
	8.6	6.7	2.5	PE-68386, PA2001	1500Vrms	Functional	-	21-30	Energy Transfer (schematic 4)	-
	8.6	6.7	3.6	PA0264, PA2004	1000Vrms	Functional	-	12-20	Energy Transfer (schematic 2)	-
	9.5	7.1	5.3	PA1323	1500Vrms	Functional	-	21.7	Energy Transfer (schematic 4)	-
	10.2	7.5	11.0	PH9572, PH9572A	1500Vrms 2500Vrms	Functional Basic	12.0	42.84	Energy Transfer (schematic 1)	-
	9.5	8.1	5.1	PH9085, PM2180	2500Vrms	Functional	-	22.24	Energy Transfer (schematic 1)	Yes*
	11.8	8.8	4.0	P0544, PA2002	1500Vdc	Functional	1.4mm	45-60	Energy Transfer (schematic 2)	-
	11.8	8.8	4.0	PA0184, PA0297, PA0510, PA2007, PA2008, PA2009	1500Vrms	Basic	1.4mm	27-53	Energy Transfer (schematic 2)	-
	11.8	8.8	4.0	PA0173, PA0185 PA2005, PA2006	1500Vrms	Basic	1.4mm	17-26	Energy Transfer (schematic 2)	-
	10.9	9.7	2.7	PA3493	1650Vrms	Basic	1.4mm	21.7	Energy Transfer (schematic 4)	-
	10.0	10.0	12.5	PH9184	4000Vrms	Basic	4.0mm	200-296	Energy Transfer (schematic 1)	-
	10.0	10.0	12.5	PH9185, PM2190	5000Vrms	Reinforced	8.0mm	36-110	Energy Transfer (schematic 1)	Yes*
	10.5	10.3	12.5	PH9496	2500Vrms	Basic	6.2mm	-	Energy Transfer (schematic 4)	-
	9.2	12.5	7.6	PH9384, PM2185	4000Vrms	Reinforced	8.3mm	-	Energy Transfer (schematic 1)	Yes*
	13.0	10.0	12.5	PH0416	5000Vrms	Reinforced	8.3mm	-	Energy Transfer (schematic 4)	-
	13.0	12.0	7.1	PH9363	2500Vrms	Basic	2.8mm	-	Energy Transfer (schematic 4)	-
	16.5	15.6	7.1	PH9385, PM2155	4000Vrms	Basic	12.0mm	70-109	Energy Transfer (schematic 1)	Yes*
	16.7	16.5	14.2	PH9400, PH9400A	4000Vrms	Basic	12.0mm	125-375	Energy Transfer (schematic 1)	-

*See specific datasheet for details

Available Schematics
(multiple turns ratios available)

