



# ±15kV ESD-Protected, EMC-Compliant, 230kbps, 3-Tx/3-Rx RS-232 IC

MAX1406

## General Description

The MAX1406 is an RS-232 IC designed to meet the stringent electrostatic discharge (ESD) requirements of the European community. All transmitter outputs and receiver inputs are protected to ±15kV using IEC1000-4-2 Air-Gap Discharge, ±8kV using IEC 1000-4-2 Contact Discharge, and ±15kV using the Human Body Model.

The MAX1406 has three RS-232 transmitters and three RS-232 receivers, and is optimized for operation in printer, modem, and telecom applications. It is guaranteed to run at data rates up to 230kbps, providing compatibility with popular software for communicating with personal computers. Power-supply current is less than 500µA for I<sub>DD</sub> and I<sub>SS</sub>, and less than 1mA for I<sub>CC</sub>.

The MAX1406 is pin and functionally compatible with the industry-standard MC145406, so existing designs can instantly become Electromagnetic Compatibility (EMC) compliant. The MAX1406 is available in DIP and SO packages, and in a tiny SSOP that reduces board space.

## Applications

- Telecommunications
- Modems
- Printers
- Instruments
- Equipment Meeting IEC1000-4-2

## Pin Configuration

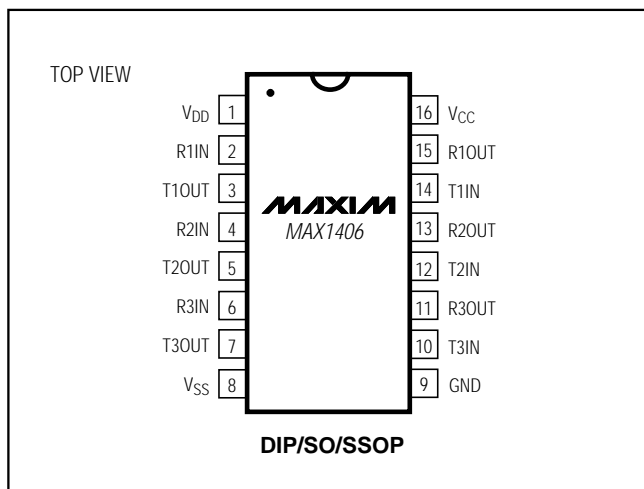

## Features

- ◆ **Enhanced ESD Protection:**
  - ±15kV Human Body Model
  - ±8kV IEC1000-4-2, Contact Discharge
  - ±15kV IEC1000-4-2, Air-Gap Discharge
- ◆ **Latchup Free During an ESD Event**
- ◆ **16-Pin SSOP or SO Packages**
- ◆ **Guaranteed 230kbps Data Rate**
- ◆ **Flow-Through Pinout**
- ◆ **Pin Compatible with MC145406**

## Ordering Information

PART	TEMP. RANGE	PIN-PACKAGE
MAX1406CPE	0°C to +70°C	16 Plastic DIP
MAX1406CWE	0°C to +70°C	16 Wide SO
MAX1406CAE	0°C to +70°C	16 SSOP
MAX1406C/D	0°C to +70°C	Dice*
MAX1406EPE	-40°C to +85°C	16 Plastic DIP
MAX1406EWE	-40°C to +85°C	16 Wide SO
MAX1406EAE	-40°C to +85°C	16 SSOP

\*Dice are specified at T<sub>A</sub> = +25°C, DC parameters only.

## Functional Diagram

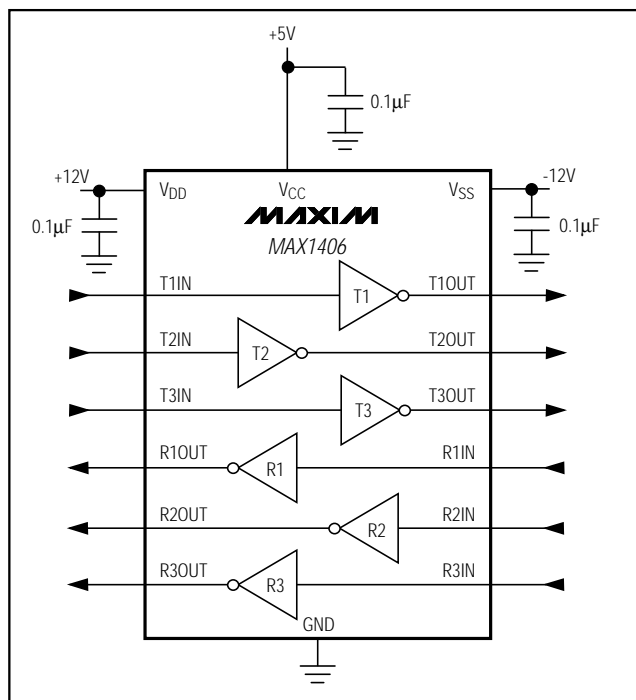

# ±15kV ESD-Protected, EMC-Compliant, 230kbps, 3-Tx/3-Rx RS-232 IC

## ABSOLUTE MAXIMUM RATINGS

V <sub>CC</sub> .....	-0.3V to +7V	Continuous Power Dissipation (T <sub>A</sub> = +70°C)
V <sub>DD</sub> .....	-0.3V to +14V	DIP (derate 10.53mW/°C above +70°C).....
V <sub>SS</sub> .....	+0.3V to -14V	Wide SO (derate 20.00mW/°C above +70°C).....
Input Voltages		SSOP (derate 8.00mW/°C above +70°C).....
T <sub>IN</sub> .....	-0.3V to +6V	Operating Temperature Ranges
R <sub>IN</sub> .....	±30V	MAX1406C_E.....
Output Voltages		MAX1406E_E.....
T <sub>OUT</sub> .....	±15V	Storage Temperature Range.....
R <sub>OUT</sub> .....	-0.3V to (V <sub>CC</sub> + 0.3V)	Lead Temperature (soldering, 10sec).....
Short-Circuit Duration		
T <sub>OUT</sub> (one at a time).....	Continuous	
R <sub>OUT</sub> (one at a time).....	Continuous	

Stresses beyond those listed under "Absolute Maximum Ratings" may cause permanent damage to the device. These are stress ratings only, and functional operation of the device at these or any other conditions beyond those indicated in the operational sections of the specifications is not implied. Exposure to absolute maximum rating conditions for extended periods may affect device reliability.

## ELECTRICAL CHARACTERISTICS

(V<sub>CC</sub> = +4.5V to +5.5V, V<sub>DD</sub> = +10.8V to +13.2V, V<sub>SS</sub> = -10.8V to -13.2V, T<sub>A</sub> = T<sub>MIN</sub> to T<sub>MAX</sub>, unless otherwise noted. Typical values are at T<sub>A</sub> = +25°C.)

PARAMETER	SYMBOL	CONDITIONS	MIN	TYP	MAX	UNITS
<b>DC CHARACTERISTICS</b>						
Operating Voltage Range	V <sub>CC</sub>		4.5		5.5	V
	V <sub>DD</sub>		10.8		13.2	
	V <sub>SS</sub>		-13.2		-10.8	
Supply Current	I <sub>CC</sub>	No load		230	1000	μA
	I <sub>DD</sub>			185	500	
	I <sub>SS</sub>			185	500	
<b>LOGIC</b>						
Input Logic Threshold Low	V <sub>ILT</sub>	T <sub>IN</sub>			0.8	V
Input Logic Threshold High	V <sub>IHT</sub>	T <sub>IN</sub>	2.0			V
Input Leakage Current				0.01	1	μA
Output Voltage Low	V <sub>OLR</sub>	R <sub>OUT</sub> ; I <sub>SINK</sub> = 3.2mA			0.4	V
Output Voltage High	V <sub>OHR</sub>	R <sub>OUT</sub> ; I <sub>SOURCE</sub> = 1mA	V <sub>CC</sub> - 0.6			V
<b>TRANSMITTER OUTPUTS</b>						
Output Voltage Swing		V <sub>DD</sub> = 7.0V, V <sub>SS</sub> = -7.0V, R <sub>L</sub> = 3kΩ	±5.0			V
		V <sub>DD</sub> = 12V, V <sub>SS</sub> = -12V, R <sub>L</sub> = 3kΩ	±9.5			
Transmitter Output Resistance		V <sub>CC</sub> = V <sub>DD</sub> = V <sub>SS</sub> = 0V, V <sub>T_OUT</sub> = ±2V	300			Ω
RS-232 Output Short-Circuit Current				±35	±60	mA
<b>RECEIVER INPUTS</b>						
Receiver Input Voltage Operating Range			-25		+25	V
RS-232 Input Threshold Low			0.75			V
RS-232 Input Threshold High					2.4	V
RS-232 Input Hysteresis				0.65		V

# *±15kV ESD-Protected, EMC-Compliant, 230kbps, 3-Tx/3-Rx RS-232 IC*

MAX1406

## ELECTRICAL CHARACTERISTICS (continued)

(V<sub>CC</sub> = +4.5V to +5.5V, V<sub>DD</sub> = +10.8V to +13.2V, V<sub>SS</sub> = -10.8V to -13.2V, T<sub>A</sub> = T<sub>MIN</sub> to T<sub>MAX</sub>, unless otherwise noted. Typical values are at T<sub>A</sub> = +25°C.)

PARAMETER	SYMBOL	CONDITIONS	MIN	TYP	MAX	UNITS
<b>RECEIVER INPUTS (continued)</b>						
RS-232 Input Resistance			3	5	7	kΩ
Receiver Output Short-Circuit Current				±10		mA
<b>ESD CHARACTERISTICS</b>						
ESD Protection		Human Body Model		±15		kV
		IEC1000-4-2 (Contact Discharge)		±8		
		IEC1000-4-2 (Air-Gap Discharge)		±15		

## TIMING CHARACTERISTICS

(T<sub>A</sub> = +25°C, unless otherwise noted.)

PARAMETER	SYMBOL	CONDITIONS		MIN	TYP	MAX	UNITS
Transmitter Output Propagation Delay, Low to High	t <sub>PLHT</sub>	V <sub>DD</sub> = 12V, V <sub>SS</sub> = -12V, R <sub>L</sub> = 3kΩ, C <sub>L</sub> = 1000pF				4	μs
Transmitter Output Propagation Delay, High to Low	t <sub>PLHT</sub>	V <sub>DD</sub> = 12V, V <sub>SS</sub> = -12V, R <sub>L</sub> = 3kΩ, C <sub>L</sub> = 1000pF				4	μs
Transmitter Propagation Delay Skew,  t <sub>PLHT</sub> - t <sub>PHLT</sub>	t <sub>SKT</sub>	V <sub>DD</sub> = 12V, V <sub>SS</sub> = -12V, R <sub>L</sub> = 3kΩ, C <sub>L</sub> = 1000pF				0.4	μs
Transition Output Slew Rate	SR	V <sub>DD</sub> = 12V, V <sub>SS</sub> = -12V, R <sub>L</sub> = 3kΩ to 7kΩ, measured from +3V to -3V or -3V to +3V	C <sub>L</sub> = 150pF to 2500pF	4	12	30	V/μs
			C <sub>L</sub> = 50pF to 1000pF	8	12	30	
Receiver Output Propagation Delay, Low to High	t <sub>PLHR</sub>	V <sub>CC</sub> = 5V, C <sub>L</sub> = 50pF				4.0	μs
Receiver Output Propagation Delay, High to Low	t <sub>PHLR</sub>	V <sub>CC</sub> = 5V, C <sub>L</sub> = 50pF				4.0	μs
Receiver Propagation Delay Skew,  t <sub>PLHR</sub> - t <sub>PHLR</sub>	t <sub>SKR</sub>	V <sub>CC</sub> = 5V, C <sub>L</sub> = 50pF				0.4	μs
Guaranteed Data Rate	DR	V <sub>CC</sub> = 5V, V <sub>DD</sub> = 12V, V <sub>SS</sub> = -12V, R <sub>L</sub> = 3kΩ to 7kΩ	C <sub>L</sub> = 150pF to 2500pF	120			kbps
			C <sub>L</sub> = 50pF to 1000pF	230			

# ±15kV ESD-Protected, EMC-Compliant, 230kbps, 3-Tx/3-Rx RS-232 IC

## Typical Operating Characteristics

(V<sub>CC</sub> = +5.0V, V<sub>DD</sub> = +12.0V, V<sub>SS</sub> = -12.0V, T<sub>A</sub> = +25°C, unless otherwise noted.)

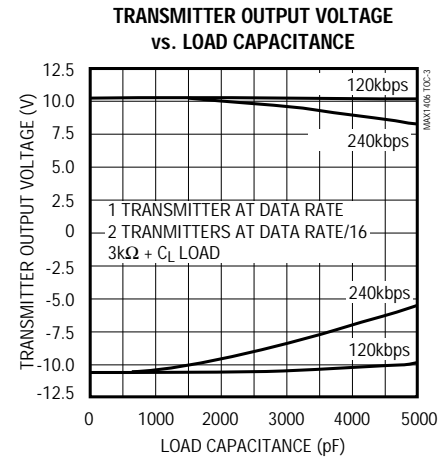
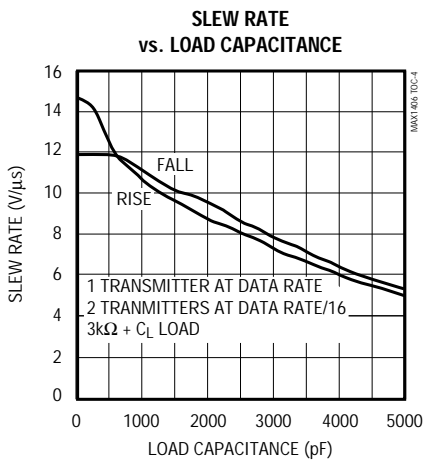
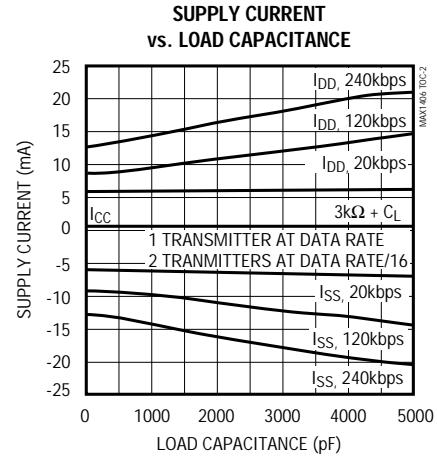
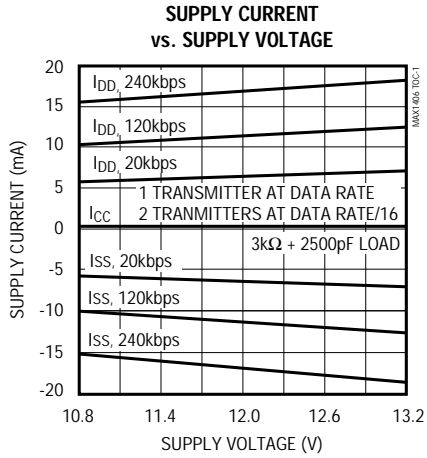

# ±15kV ESD-Protected, EMC-Compliant, 230kbps, 3-Tx/3-Rx RS-232 IC

MAX1406

## Pin Description

PIN	NAME	FUNCTION
1	V <sub>DD</sub>	Supply-Voltage Input, +10.8V to +13.2V
3, 5, 7	T1OUT, T2OUT, T3OUT	Transmitter Outputs, swing between V <sub>DD</sub> and V <sub>SS</sub>
2, 4, 6	R1IN, R2IN, R3IN	Receiver Inputs
8	V <sub>SS</sub>	Supply-Voltage Input, -10.8V to -13.2V
9	GND	Ground. Connect to system ground.
10, 12, 14	T3IN, T2IN, T1IN	Transmitter Inputs. Tie unused inputs to GND or V <sub>CC</sub> .
11, 13, 15	R3OUT, R2OUT, R1OUT	Receiver Outputs, swing between GND and V <sub>CC</sub>
16	V <sub>CC</sub>	Supply-Voltage Input, +4.5V to +5.5V

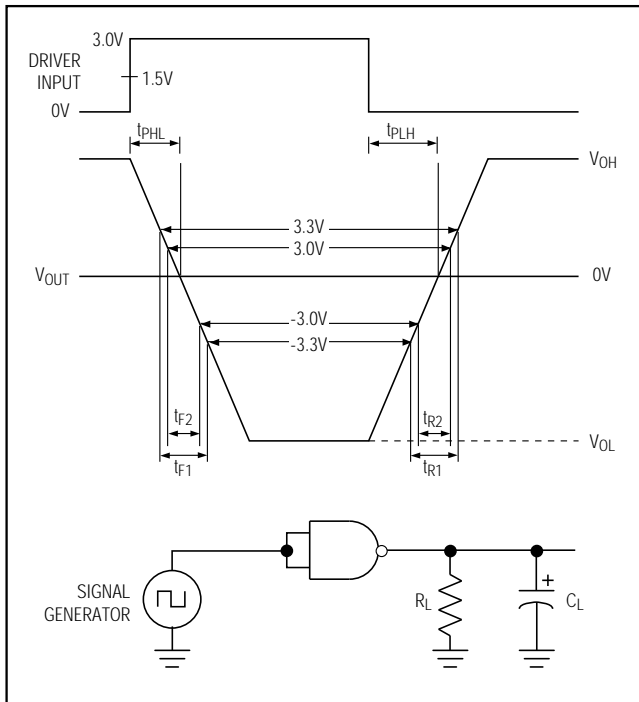

Figure 1. Slew-Rate Test Circuit and Timing Diagram

## Detailed Description

### RS-232 Transmitters

The transmitters are inverting level translators that convert CMOS-logic input levels to an EIA/TIA-232 voltage between ±5V and ±13.2V, into a load between 3kΩ and 7kΩ. The MAX1406 guarantees a 230kbps data rate with a worst-case load of 3kΩ and 1000pF, providing compatibility with PC-to-PC communication software.

When the power is off, the MAX1406 outputs are permitted to be driven up to ±15V. The transmitter inputs do not have internal pull-up resistors. Connect unused inputs to GND or V<sub>CC</sub>.

### RS-232 Receivers

The receiver inputs invert and convert the RS-232 signals to CMOS-logic output levels. The MAX1406 has hysteresis of 650mV. The receiver output swings between GND and V<sub>CC</sub>.

### ±15kV ESD Protection

As with all Maxim devices, electrostatic discharge (ESD) protection structures are incorporated on all pins to protect against ESD encountered during handling and assembly. The MAX1406 driver outputs and receiver inputs have extra protection against static electricity found in normal operation. Maxim's engineers developed state-of-the-art structures to protect these pins against ±15kV ESD without damage. After an ESD event, the MAX1406 continues working without latchup.

ESD protection can be tested in several ways. The transmitter outputs and the receiver inputs are characterized for protection to the following:

- 1) ±15kV using the Human Body Model
- 2) ±8kV using the Contact-Discharge method specified in IEC1000-4-2 (formerly IEC801-2)
- 3) ±15kV using the Air-Gap Discharge method specified in IEC1000-4-2 (formerly IEC801-2)

### ESD Test Conditions

ESD performance depends on a number of conditions. Contact Maxim for a reliability report that documents test setup, methodology, and results.

# ±15kV ESD-Protected, EMC-Compliant, 230kbps, 3-Tx/3-Rx RS-232 IC

## Human Body Model

Figure 2a shows the Human Body Model, and Figure 2b shows the current waveform it generates when discharged into a low impedance. This model consists of a 100pF capacitor charged to the ESD voltage of interest, which is then discharged into the device through a 1.5kΩ resistor.

## IEC1000-4-2

The IEC1000-4-2 standard covers ESD testing and performance of finished equipment; it does not specifically refer to integrated circuits. The MAX1406 helps you design equipment that meets Level 4 (the highest level) of IEC1000-4-2, without additional ESD-protection components.

The main difference between tests done using the Human Body Model and IEC1000-4-2 is higher peak current in IEC1000-4-2 (Figure 3). Because series resistance is lower in the IEC1000-4-2 ESD test model, the

ESD withstand voltage measured to this standard is generally lower than that measured using the Human Body Model. Figure 3b shows the current waveform for the ±8kV IEC1000-4-2 Level 4 ESD Contact-Discharge test.

The Air-Gap test involves approaching the device with a charge probe. The Contact-Discharge method connects the probe to the device before the probe is energized.

## Machine Model

The Machine Model for ESD testing uses a 200pF storage capacitor and zero-discharge resistance. It mimics the stress caused by handling during manufacturing and assembly. Of course, all pins (not just RS-232 inputs and outputs) require this protection during manufacturing. Therefore, the Machine Model is less relevant to the I/O ports than are the Human Body Model and IEC1000-4-2.

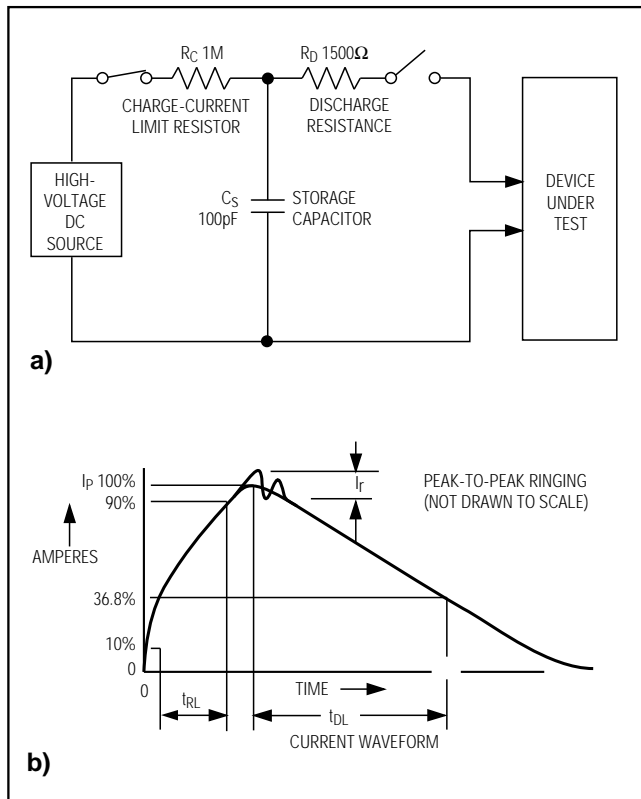

Figure 2. Human Body ESD Test Model and ESD-Generator Current Waveform

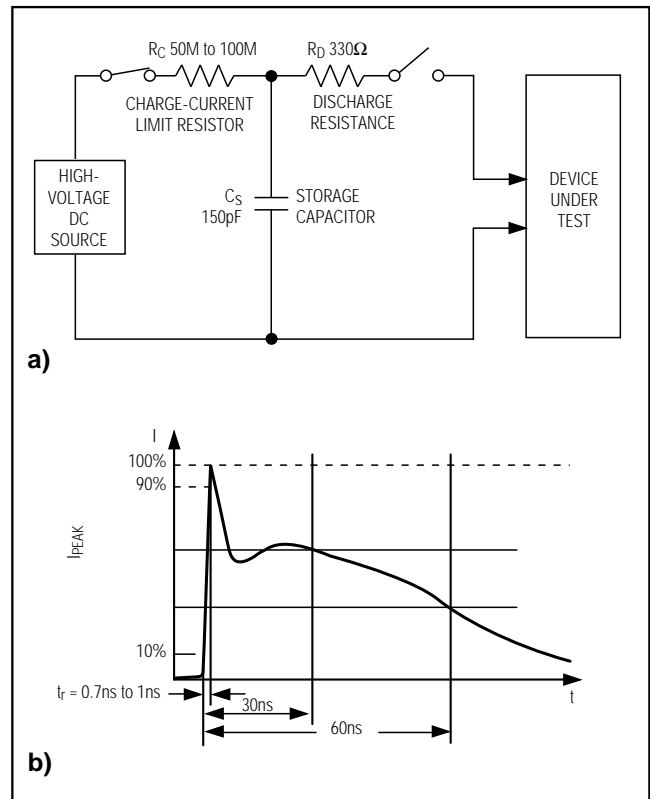

Figure 3. IEC1000-4-2 Test Model and ESD-Generator Current Waveform

# $\pm 15\text{kV}$ ESD-Protected, EMC-Compliant, 230kbps, 3-Tx/3-Rx RS-232 IC

MAX1406

## Applications Information

Because the MAX1406 is not sensitive to power-supply sequencing, no external protection diodes are required. Any of the three supplies can power up first. However, use proper layout techniques to ensure other devices on your board are not damaged in case of an ESD event.

- Minimize the ground-lead return path to the power supply, because currents as high as 60A can pass into the ground.
- Use a separate return path to the power supply.
- Make trace widths greater than 40 mils.
- Bypass  $V_{CC}$ ,  $V_{DD}$ , and  $V_{SS}$  with  $0.1\mu\text{F}$  capacitors as close to the MAX1406 as possible to ensure maximum ESD protection.
- Tie any unused transmitter inputs to GND or  $V_{CC}$  to minimize power consumption.

## Chip Topography

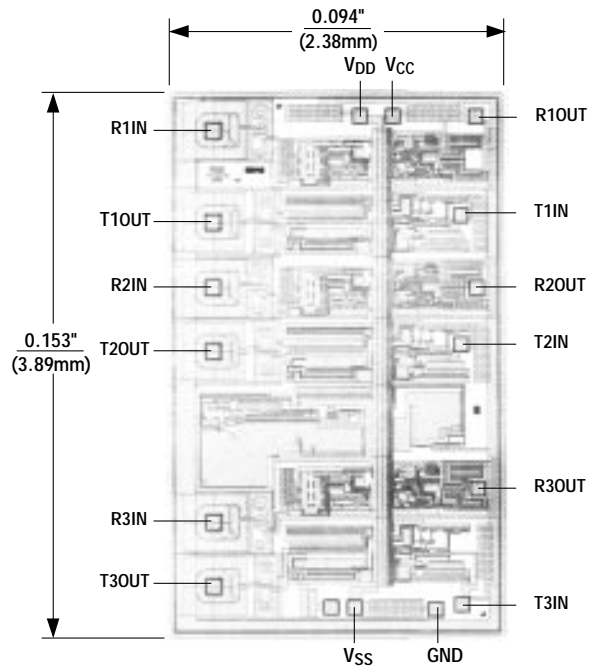

TRANSISTOR COUNT: 161

SUBSTRATE CONNECTED TO GND

$\pm 15\text{kV}$  ESD-Protected, EMC-Compliant,  
230kbps, 3-Tx/3-Rx, RS-232 IC

Package Information

**Plastic DIP  
PLASTIC  
DUAL-IN-LINE  
PACKAGE  
(0.300 in.)**

DIM	INCHES		MILLIMETERS	
	MIN	MAX	MIN	MAX
A	—	0.200	—	5.08
A1	0.015	—	0.38	—
A2	0.125	0.175	3.18	4.45
A3	0.055	0.080	1.40	2.03
B	0.016	0.022	0.41	0.56
B1	0.045	0.065	1.14	1.65
C	0.008	0.012	0.20	0.30
D1	0.005	0.080	0.13	2.03
E	0.300	0.325	7.62	8.26
E1	0.240	0.310	6.10	7.87
e	0.100	—	2.54	—
eA	0.300	—	7.62	—
eB	—	0.400	—	10.16
L	0.115	0.150	2.92	3.81

PKG.	DIM	PINS	INCHES		MILLIMETERS	
			MIN	MAX	MIN	MAX
P	D	8	0.348	0.390	8.84	9.91
P	D	14	0.735	0.765	18.67	19.43
P	D	16	0.745	0.765	18.92	19.43
P	D	18	0.885	0.915	22.48	23.24
P	D	20	1.015	1.045	25.78	26.54
N	D	24	1.14	1.265	28.96	32.13

21-0043A

**Wide SO  
SMALL-OUTLINE  
PACKAGE  
(0.300 in.)**

DIM	INCHES		MILLIMETERS	
	MIN	MAX	MIN	MAX
A	0.093	0.104	2.35	2.65
A1	0.004	0.012	0.10	0.30
B	0.014	0.019	0.35	0.49
C	0.009	0.013	0.23	0.32
E	0.291	0.299	7.40	7.60
e	0.050		1.27	
H	0.394	0.419	10.00	10.65
L	0.016	0.050	0.40	1.27

DIM	PINS	INCHES		MILLIMETERS	
		MIN	MAX	MIN	MAX
D	16	0.398	0.413	10.10	10.50
D	18	0.447	0.463	11.35	11.75
D	20	0.496	0.512	12.60	13.00
D	24	0.598	0.614	15.20	15.60
D	28	0.697	0.713	17.70	18.10

21-0042A

Maxim cannot assume responsibility for use of any circuitry other than circuitry entirely embodied in a Maxim product. No circuit patent licenses are implied. Maxim reserves the right to change the circuitry and specifications without notice at any time.

8 Maxim Integrated Products, 120 San Gabriel Drive, Sunnyvale, CA 94086 (408) 737-7600