

# LVDS 1-Bit, High-Speed Differential Receiver

## FIN1002

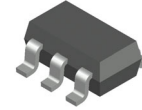

SOT-23, 5 Lead  
CASE 527AH

### Description

This single receiver is designed for high-speed interconnects utilizing Low Voltage Differential Signaling (LVDS) technology. The receiver translates LVDS levels, with a typical differential input threshold of 100 mV, to LVTTTL signal levels. LVDS provides low EMI at ultra low power dissipation even at high frequencies. This device is ideal for high-speed transfer of clock or data. The FIN1002 can be paired with its companion driver, the FIN1001, or with any other LVDS driver.

### Features

- Greater than 400 Mbs Data Rate
- 3.3 V Power Supply Operation
- 0.4 ns Maximum Pulse Skew
- 2.5 ns Maximum Propagation Delay
- Bus Pin ESD (HBM) Protection Exceeds 10 kV
- Power-Off, Over-voltage Tolerant Input and Output
- Fail-safe Protection for open-circuit and Non-driven, Shorted, or Terminated Conditions
- High-impedance Output at  $V_{CC} < 1.5$  V
- Meets or exceeds TIA/EIA-644 LVDS Standard
- 5-Lead SOT23 Package Saves Space

### PIN DEFINITIONS

Pin No.	Function	Description
1	$V_{CC}$	Power Supply
2	GND	Ground for the IC
3	$R_{IN+}$	Non-inverting Driver Input
4	$R_{IN-}$	Inverting Driver Input
5	$R_{OUT}$	LVTTTL Data Output

### FUNCTION TABLE

Inputs		Outputs
$R_{IN+}$	$R_{IN-}$	$R_{OUT}$
LOW	HIGH	LOW
HIGH	LOW	HIGH
Fail-Safe Condition (Open, Shorted, Terminated)		HIGH

### MARKING DIAGRAM

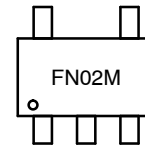

FN02 = Specific Device Code  
M = Date Code

### CONNECTION DIAGRAM

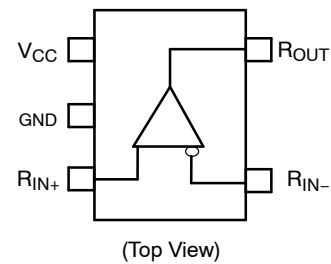

### PIN CONFIGURATION

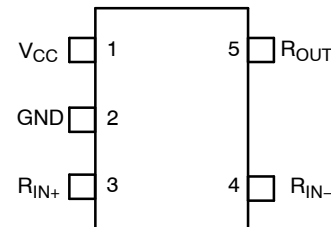

### ORDERING INFORMATION

See detailed ordering and shipping information on page 7 of this data sheet.

# FIN1002

## ABSOLUTE MAXIMUM RATINGS

Symbol	Parameter		Min.	Max.	Unit
V <sub>CC</sub>	Supply Voltage		-0.5	4.6	V
R <sub>IN+</sub> / R <sub>IN-</sub>	Input Voltage		-0.5	4.6	V
D <sub>OUT</sub>	DC Output Voltage		-0.5	6.0	V
I <sub>O</sub>	Output Current			16	mA
T <sub>STG</sub>	Storage Temperature Range		-65	+150	°C
T <sub>J</sub>	Maximum Junction Temperature			+150	°C
T <sub>L</sub>	Lead Temperature, Soldering, 10 Seconds			+260	°C
ESD	Electrostatic Discharge	Human Body Model	All Pins	8	kV
			LVDS Pins to GND	10	
		Machine Model		400	V

Stresses exceeding those listed in the Maximum Ratings table may damage the device. If any of these limits are exceeded, device functionality should not be assumed, damage may occur and reliability may be affected.

## RECOMMENDED OPERATING RANGES

Symbol	Parameter	Min.	Max.	Unit
V <sub>CC</sub>	Supply Voltage	3.0	3.6	V
V <sub>IN</sub>	Input Voltage	0	V <sub>CC</sub>	V
V <sub>ID</sub>	Magnitude of Differential Voltage	100	V <sub>CC</sub>	mV
V <sub>IC</sub>	Common-mode Input Voltage	0 +  V <sub>ID</sub>   / 2	2.4 -  V <sub>ID</sub>   / 2	V
T <sub>A</sub>	Operating Temperature	-40	+125	°C

Functional operation above the stresses listed in the Recommended Operating Ranges is not implied. Extended exposure to stresses beyond the Recommended Operating Ranges limits may affect device reliability.

## DC ELECTRICAL CHARACTERISTICS (Note 1)

All min. and max. values are guaranteed at T<sub>A</sub> = -40 to +125°C. All typical values are at T<sub>A</sub> = 25°C and with V<sub>CC</sub> = 3.3 V, unless otherwise specified.

Symbol	Parameter	Test Conditions	Min.	Typ.	Max.	Unit
V <sub>TH</sub>	Differential Input Threshold HIGH	V <sub>IC</sub> = +0.05 V, 1.2 V, or 2.35 V (Figure 1)			100	mV
V <sub>TL</sub>	Differential Input Threshold LOW	V <sub>IC</sub> = +0.05 V, 1.2 V, or 2.35 V (Figure 1)	-100			mV
I <sub>IN</sub>	Input Current	V <sub>IN</sub> = 0 V or V <sub>CC</sub>			±20	μA
I <sub>I(OFF)</sub>	Power-OFF Input Current	V <sub>CC</sub> = 0 V, V <sub>IN</sub> = 0 V or 3.6 V			±20	μA
V <sub>OH</sub>	Output HIGH Voltage	I <sub>OH</sub> = -100 μA	V <sub>CC</sub> - 0.2	3.3		V
		I <sub>OH</sub> = -8 mA	2.4	3.1		
V <sub>OL</sub>	Output LOW Voltage	I <sub>OH</sub> = 100 μA		0	0.2	V
		I <sub>OL</sub> = 8 mA		0.16	0.50	
V <sub>IK</sub>	Input Clamp Voltage	I <sub>IK</sub> = -18 mA	-1.5	0.8		V
I <sub>CC</sub>	Power Supply Current	(R <sub>IN+</sub> = 1 V and R <sub>IN-</sub> = 1.4 V) or (R <sub>IN+</sub> = 1.4 V and R <sub>IN-</sub> = 1 V)		4	7	mA
C <sub>IN</sub>	Input Capacitance	V <sub>CC</sub> = 3.3 V		2.3		pF
C <sub>OUT</sub>	Output Capacitance	V <sub>CC</sub> = 0 V		2.8		pF

1. Not production tested across the full temperature range.

**AC ELECTRICAL CHARACTERISTICS**

All min. and max. values are guaranteed at  $T_A = -40$  to  $+85^\circ\text{C}$ . All typical values are at  $T_A = 25^\circ\text{C}$  and with  $V_{CC} = 3.3\text{ V}$ , unless otherwise specified.

$|V_{ID}| = 400\text{ mV}$ ,  $C_L = 10\text{ pF}$ . See Figure 1 and Figure 2.

Symbol	Parameter	Test Conditions	Min.	Typ.	Max.	Unit
$t_{PLH}$	Propagation Delay	LOW to HIGH	0.9	1.5	2.5	ns
$t_{PHL}$	Propagation Delay	HIGH to LOW	0.9	1.5	2.5	ns
$t_{TLH}$	Output Rise Time	20% to 80%		0.6		ns
$t_{THL}$	Output Fall Time	80% to 20%		0.5		ns
$t_{SK(p)}$	Pulse Skew	$ t_{PLH} - t_{PHL} $		0.02	0.4	ns
$t_{SK(PP)}$	Part-to-Part Skew (Note 2)				1.0	ns

- $t_{SK(PP)}$  is the magnitude of the difference in propagation delay times between any specified terminals of two devices switching in the same direction (either LOW-to-HIGH or HIGH-to-LOW) when both devices operate with the same supply voltage, same temperature, and have identical test circuits.

**TEST DIAGRAMS**

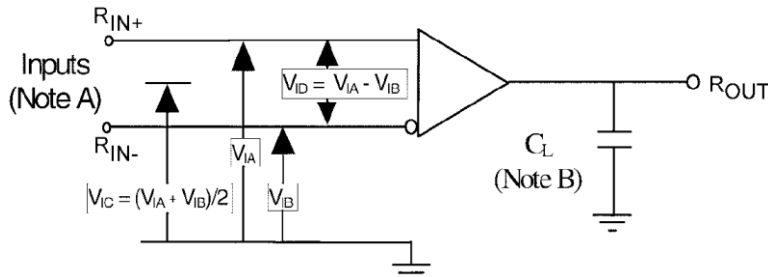

Note A: All input pulses have frequency = 10MHz,  $t_r$  or  $t_f = 1\text{ ns}$   
 Note B:  $C_L$  includes all probe and fixture capacitances

**Figure 1. Differential Receiver Voltage Definitions and Propagation Delay and Transition Time Test Circuit**

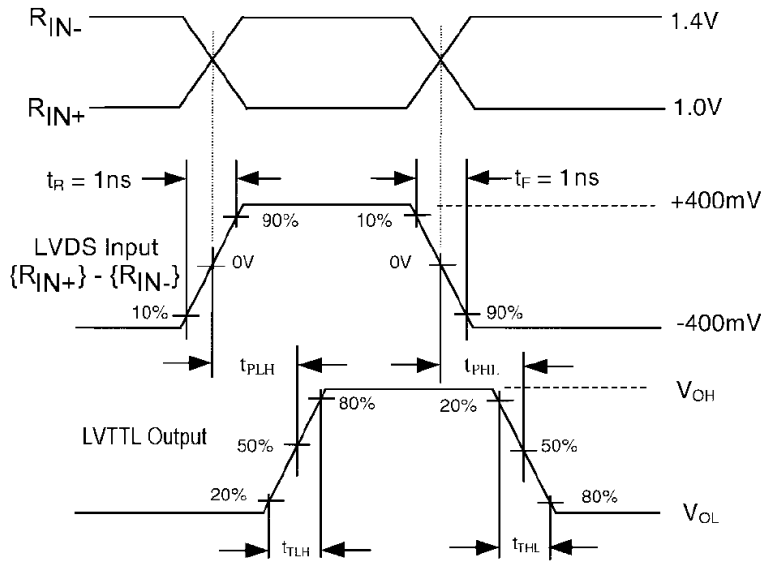

**Figure 2. LVDS Input to LVTTTL Output AC Waveforms**

TYPICAL CHARACTERISTICS

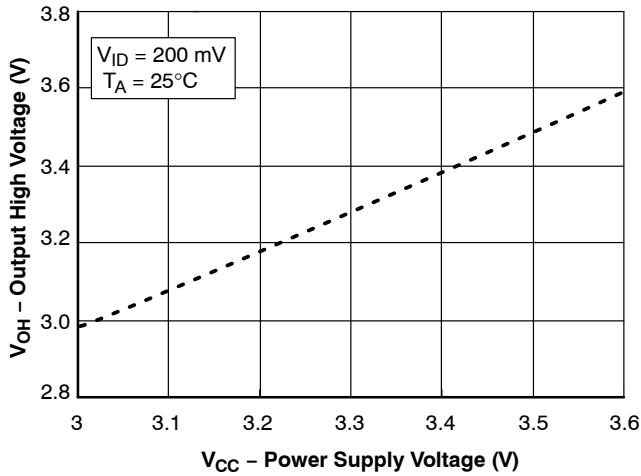

Figure 3. Output High Voltage vs. Power Supply Voltage

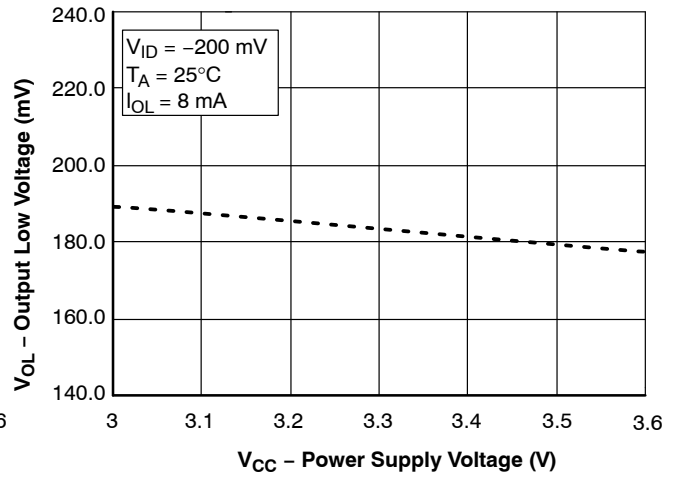

Figure 4. Output Low Voltage vs. Power Supply Voltage

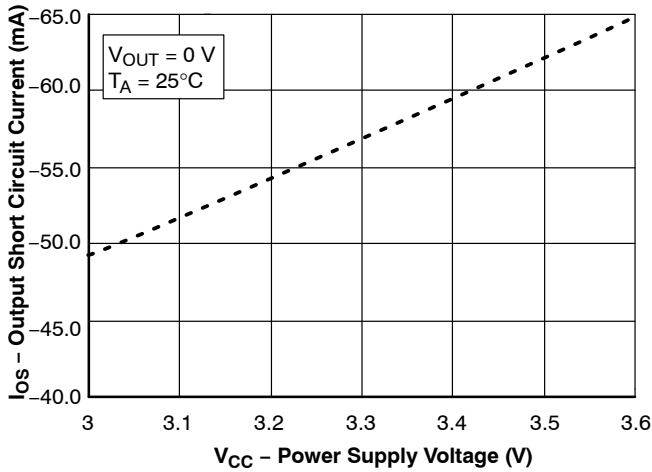

Figure 5. Output Short Circuit Current vs. Power Supply Voltage

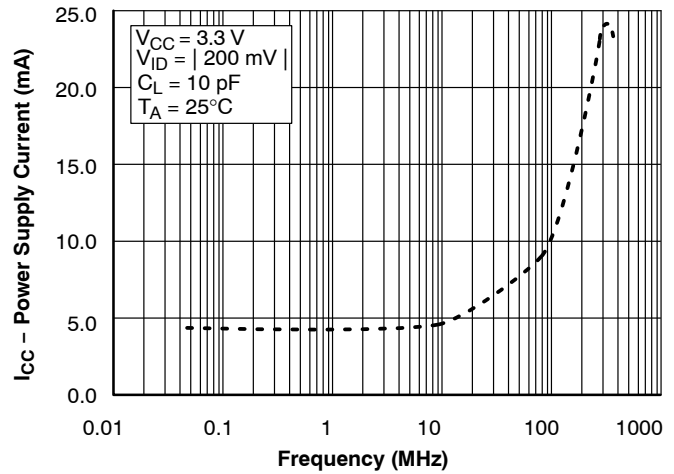

Figure 6. Power Supply Current vs. Frequency

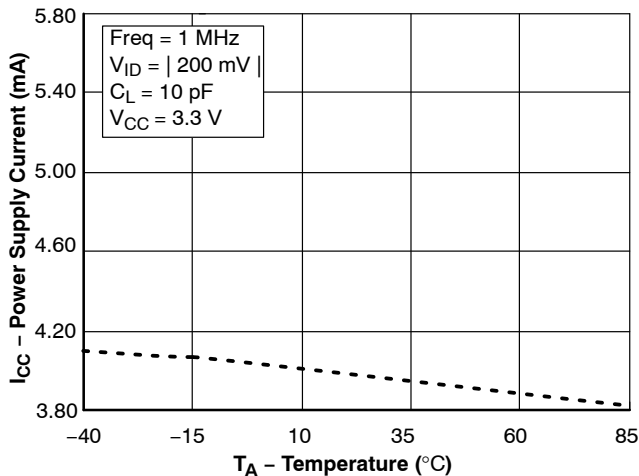

Figure 7. Power Supply Current vs. Ambient Temperature

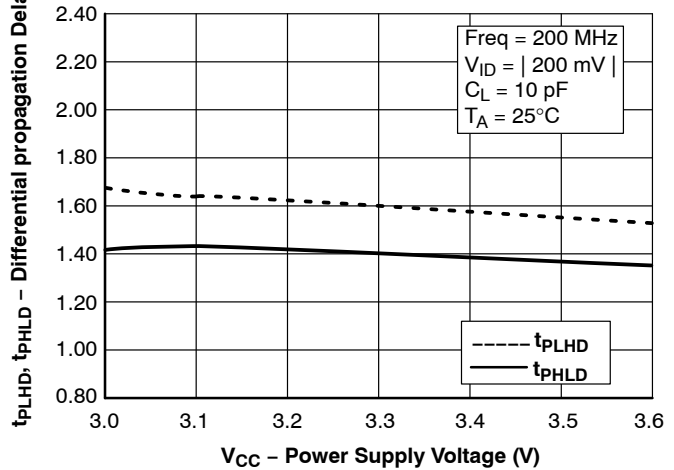

Figure 8. Differential Propagation Delay vs. Power Supply Voltage

TYPICAL CHARACTERISTICS (continued)

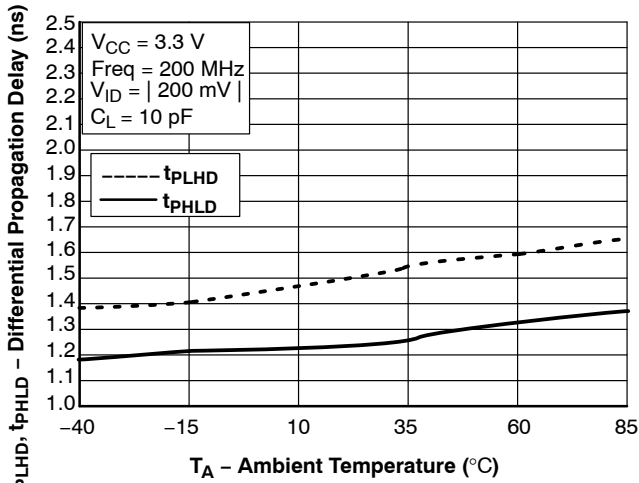

Figure 9. Differential Propagation Delay vs. Ambient Temperature

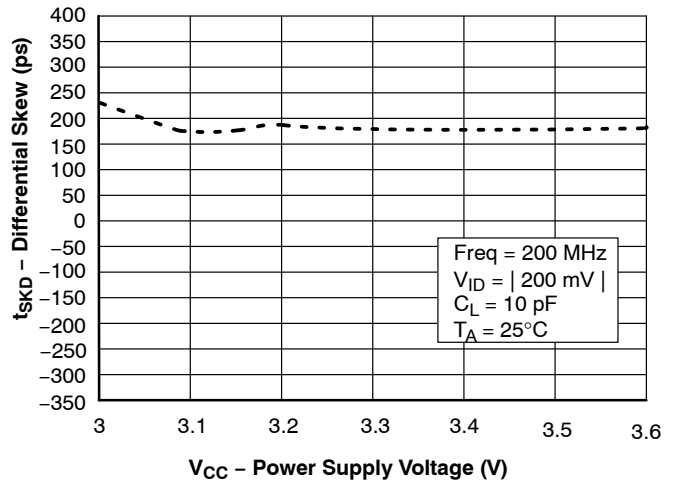

Figure 10. Differential Skew vs. Power Supply Voltage

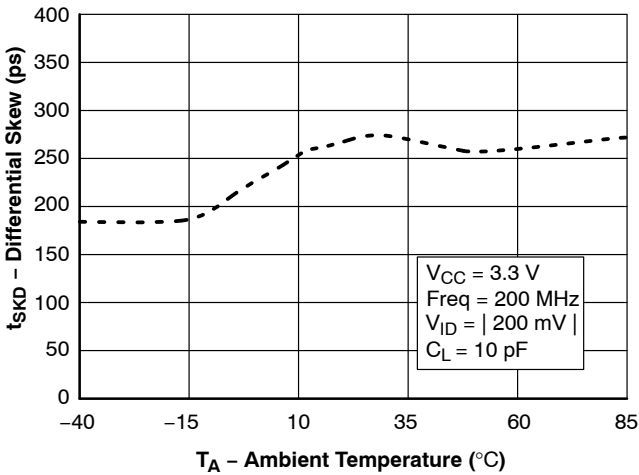

Figure 11. Differential Skew vs. Ambient Temperature

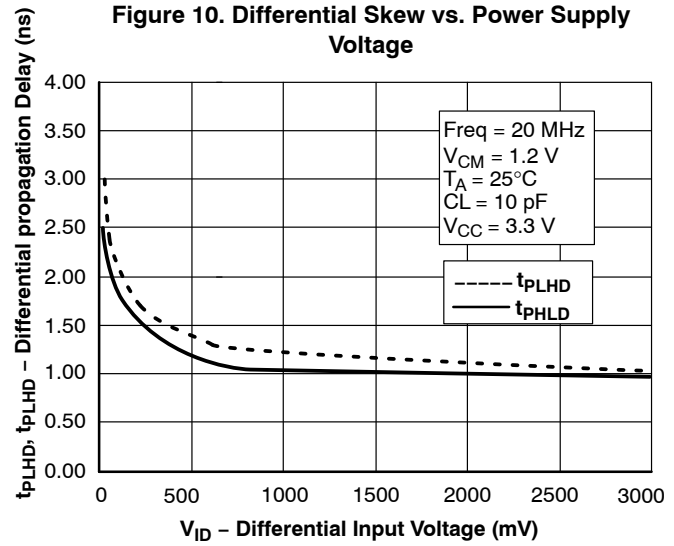

Figure 12. Differential Propagation Delay vs. Differential Input Voltage

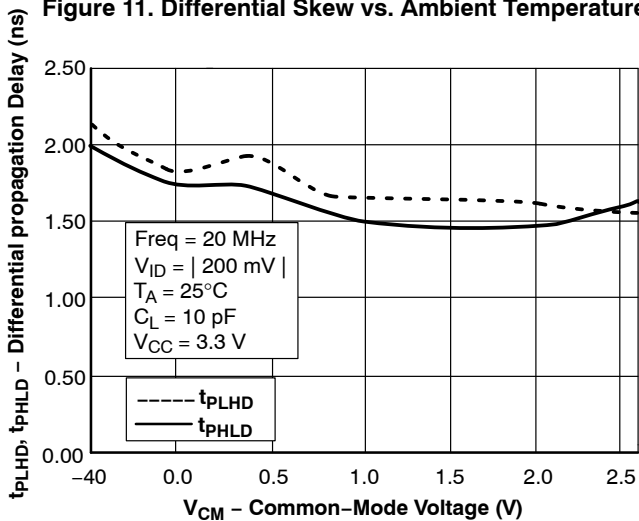

Figure 13. Differential Propagation Delay vs. Common-Mode Voltage

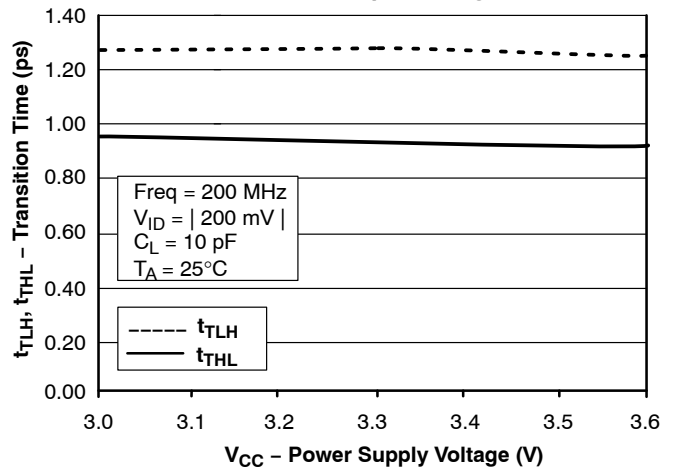

Figure 14. Transition Time vs. Power Supply Voltage

TYPICAL CHARACTERISTICS (continued)

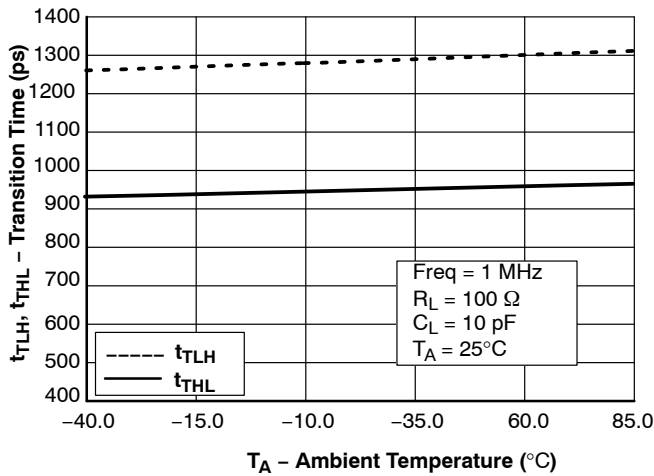

Figure 15. Transition Time vs. Ambient Temperature

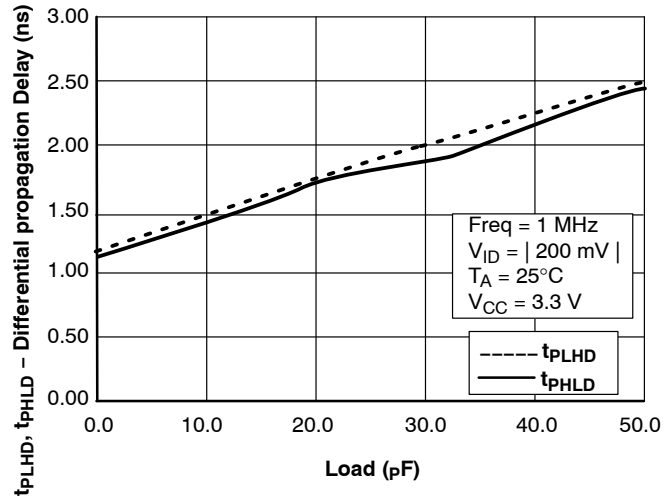

Figure 16. Differential Propagation Delay vs. Load

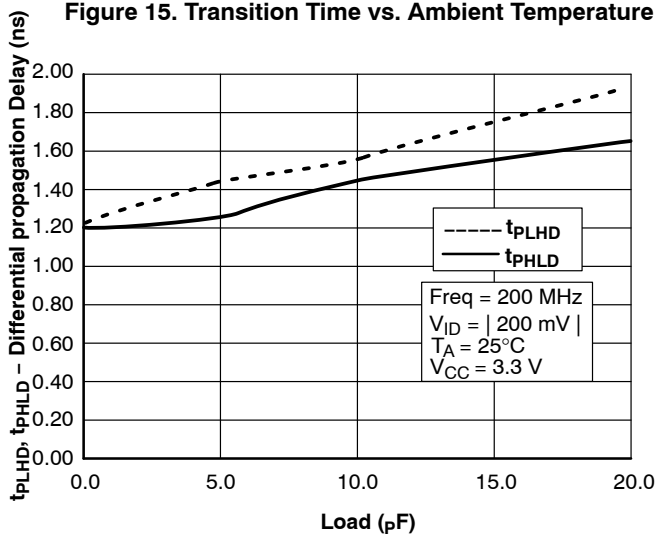

Figure 17. Differential Propagation Delay vs. Load

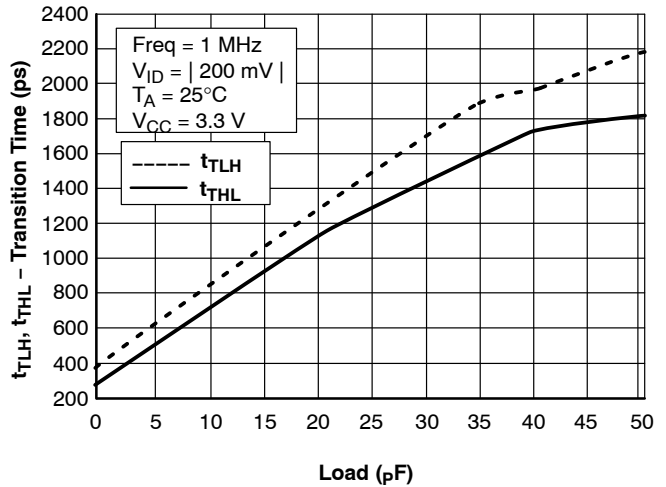

Figure 18. Transition Time vs. Load

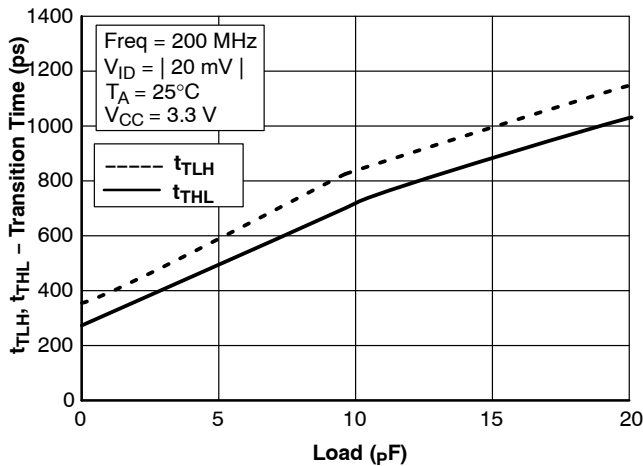

Figure 19. Transition Time vs. Load

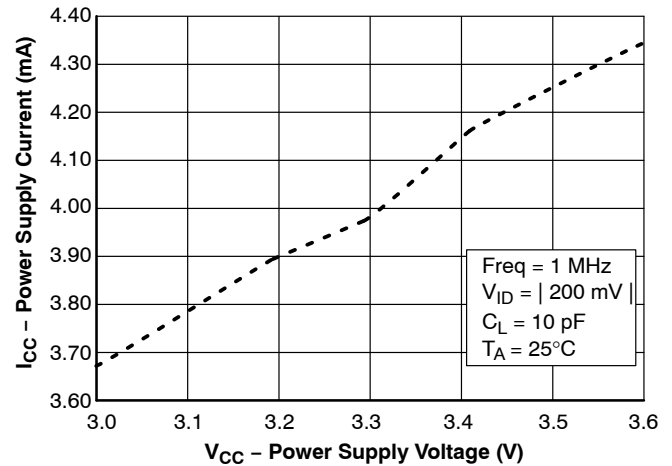

Figure 20. Power Supply Current vs. Power Supply Voltage

# FIN1002

## ORDERING INFORMATION

Product Number	Package	Shipping†
FIN1002M5X	5 Lead SOT23, JEDEC MO-178, 1.6 mm (Pb-Free)	3000 / Tape and Reel

†For information on tape and reel specifications, including part orientation and tape sizes, please refer to our Tape and Reel Packaging Specifications Brochure, [BRD8011/D](#).

# MECHANICAL CASE OUTLINE PACKAGE DIMENSIONS

ON Semiconductor®



## SOT-23, 5 Lead CASE 527AH ISSUE A

DATE 09 JUN 2021



NOTES:

1. DIMENSIONING AND TOLERANCING PER ASME Y14.5M, 1989A
2. CONTROLLING DIMENSION: MILLIMETERS
3. MAXIMUM LEAD THICKNESS INCLUDES LEAD FINISH THICKNESS. MINIMUM LEAD THICKNESS IS THE MINIMUM THICKNESS OF THE BASE MATERIAL.
4. DIMENSIONS D AND E1 DO NOT INCLUDE MOLD FLASH, PROTRUSIONS, OR GATE BURRS. MOLD FLASH, PROTRUSIONS, OR GATE BURRS SHALL NOT EXCEED 0.25 PER SIDE. D AND E1 DIMENSIONS ARE DETERMINED AT DATUM D.
5. DIMENSION 'b' DOES NOT INCLUDE DAMBAR PROTRUSION. ALLOWABLE DAMBAR PROTRUSION SHALL BE 0.08mm TOTAL IN EXCESS OF THE 'b' DIMENSION AT MAXIMUM MATERIAL CONDITION. MINIMUM SPACE BETWEEN PROTRUSION AND AN ADJACENT LEAD SHALL NOT BE LESS THAN 0.07mm.



DIM	MILLIMETERS		
	MIN.	NOM.	MAX.
A	0.90	—	1.45
A1	0.00	—	0.15
A2	0.90	1.15	1.30
b	0.30	—	0.50
c	0.08	—	0.22
D	2.90 BSC		
E	2.80 BSC		
E1	1.60 BSC		
e	0.95 BSC		
L	0.30	0.45	0.60
L1	0.60 REF		
L2	0.25 REF		
theta	0°	4°	8°
theta1	0°	10°	15°
theta2	0°	10°	15°

### GENERIC MARKING DIAGRAM\*



XXX = Specific Device Code  
M = Date Code

\*This information is generic. Please refer to device data sheet for actual part marking. Pb-Free indicator, "G" or microdot "•", may or may not be present. Some products may not follow the Generic Marking.

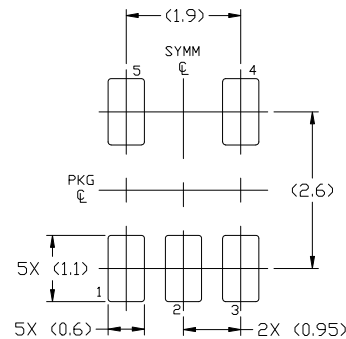

For additional information on our Pb-Free strategy and soldering details, please download the ON Semiconductor Soldering and Mounting Techniques Reference Manual, SOLDERRM/D.

DOCUMENT NUMBER:	98AON34320E	Electronic versions are uncontrolled except when accessed directly from the Document Repository. Printed versions are uncontrolled except when stamped "CONTROLLED COPY" in red.
DESCRIPTION:	SOT-23, 5 LEAD	PAGE 1 OF 1

ON Semiconductor and ON are trademarks of Semiconductor Components Industries, LLC dba ON Semiconductor or its subsidiaries in the United States and/or other countries. ON Semiconductor reserves the right to make changes without further notice to any products herein. ON Semiconductor makes no warranty, representation or guarantee regarding the suitability of its products for any particular purpose, nor does ON Semiconductor assume any liability arising out of the application or use of any product or circuit, and specifically disclaims any and all liability, including without limitation special, consequential or incidental damages. ON Semiconductor does not convey any license under its patent rights nor the rights of others.



**onsemi**, **Onsemi**, and other names, marks, and brands are registered and/or common law trademarks of Semiconductor Components Industries, LLC dba "**onsemi**" or its affiliates and/or subsidiaries in the United States and/or other countries. **onsemi** owns the rights to a number of patents, trademarks, copyrights, trade secrets, and other intellectual property. A listing of **onsemi**'s product/patent coverage may be accessed at [www.onsemi.com/site/pdf/Patent-Marking.pdf](http://www.onsemi.com/site/pdf/Patent-Marking.pdf). **onsemi** reserves the right to make changes at any time to any products or information herein, without notice. The information herein is provided "as-is" and **onsemi** makes no warranty, representation or guarantee regarding the accuracy of the information, product features, availability, functionality, or suitability of its products for any particular purpose, nor does **onsemi** assume any liability arising out of the application or use of any product or circuit, and specifically disclaims any and all liability, including without limitation special, consequential or incidental damages. Buyer is responsible for its products and applications using **onsemi** products, including compliance with all laws, regulations and safety requirements or standards, regardless of any support or applications information provided by **onsemi**. "Typical" parameters which may be provided in **onsemi** data sheets and/or specifications can and do vary in different applications and actual performance may vary over time. All operating parameters, including "Typicals" must be validated for each customer application by customer's technical experts. **onsemi** does not convey any license under any of its intellectual property rights nor the rights of others. **onsemi** products are not designed, intended, or authorized for use as a critical component in life support systems or any FDA Class 3 medical devices or medical devices with a same or similar classification in a foreign jurisdiction or any devices intended for implantation in the human body. Should Buyer purchase or use **onsemi** products for any such unintended or unauthorized application, Buyer shall indemnify and hold **onsemi** and its officers, employees, subsidiaries, affiliates, and distributors harmless against all claims, costs, damages, and expenses, and reasonable attorney fees arising out of, directly or indirectly, any claim of personal injury or death associated with such unintended or unauthorized use, even if such claim alleges that **onsemi** was negligent regarding the design or manufacture of the part. **onsemi** is an Equal Opportunity/Affirmative Action Employer. This literature is subject to all applicable copyright laws and is not for resale in any manner.

## PUBLICATION ORDERING INFORMATION

### LITERATURE FULFILLMENT:

Email Requests to: [orderlit@onsemi.com](mailto:orderlit@onsemi.com)

**onsemi Website:** [www.onsemi.com](http://www.onsemi.com)

### TECHNICAL SUPPORT

**North American Technical Support:**

Voice Mail: 1 800-282-9855 Toll Free USA/Canada

Phone: 011 421 33 790 2910

**Europe, Middle East and Africa Technical Support:**

Phone: 00421 33 790 2910

For additional information, please contact your local Sales Representative