

SR-SERIES

Single output 20W ~ 660W

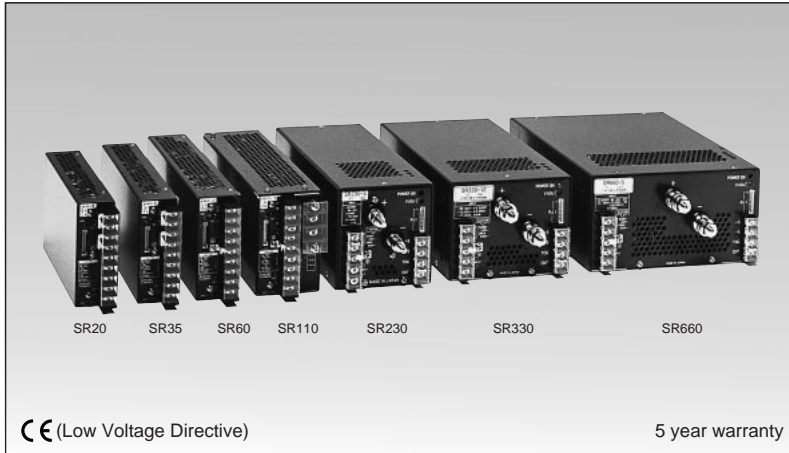

Model name SR 60-5

Output voltage: 2 ~ 48V
Output power: 20 ~ 660W
Name of series

Features

- CE marking (Low Voltage Directive)
- Long life and high reliability
Lifetime: 10 years or more, 40°C at full load (Internal fan is spare part)
- Wide operating temperature range: -20 ~ +71°C
- Input voltage range: 85 ~ 132VAC / 170 ~ 265VAC
- 77 models, 15W ~ 660W
- 5 year warranty

Specifications

1. Input voltage range	85 ~ 132VAC/170 ~ 265VAC (47 ~ 440Hz), 230 ~ 330VDC user selectable
2. Output voltage range	SR20 ~ SR110 : ± 10%, SR230 ~ SR660 : ±20%, (2V output : -10 ~ +20%, 5V output : -20 ~ +10%)
3. Line and load regulation	Line regulation: 0.4% (2V output : 20mV), Load regulation: 0.4% (2V output : 20 mV)
4. Maximum ripple & noise	50mV : 2 ~ 6V output, 60mV : 9 ~ 15V output, 80mV : 18 ~ 28V output 90mV : 30 ~ 36V output, 100mV : 48V output type
5. Cooling	SR20, 35, 60, 110 : Convection cooling, SR230, 330, 660 : forced air cooling by internal fan
6. Operating ambient temperature (Standard mounting)	-20 ~ +71°C (SR20, 35, 60, 110 . . . +61 ~ +71°C : Forced air cooling) SR20, 35... -20 ~ +71°C/-20°C: 50%, 0 ~ +40°C: 100%, +60°C: 60%, +71°C: 50% SR60, 110... -20 ~ +71°C/-20°C: 50%, 0 ~ +40°C: 100%, +60°C: 70%, +71°C: 50% SR230, 330, 660... -20 ~ +71°C/-20°C: 60%, 0 ~ +40°C: 100%, +60°C: 70%, +71°C: 50%
7. Withstand voltage	Input-output: 3.75kVAC, input-FG : 2.5kVAC, output-FG : 500VAC for 1 min.
8. Safety standard	Approved by UL1950 , CSA950 and EN60950
9. EMI	Conforms to VCCI-class 1 and FCC class A
10. Functions	Over voltage protection, Over current protection, Thermal protection, Remote sensing, Remote on/off control, Power-failure signal, Output current balancing, Fan alarm signal

* Output derating of output voltage range and operating ambient temperature are different according to models.

Product lineup

Model name	Nominal output voltage	Max. output current	Max. output power	UL	CSA	EN	
SR20	SR20-2	2V	4A	8W	○	○	Δ
	SR20-5	5V	4A	20W	○	○	○
	SR20-6	6V	3.3A	19.8W	○	○	Δ
	SR20-9	9V	2.2A	19.8W	○	○	Δ
	SR20-12	12V	1.7A	20.4W	○	○	○
	SR20-15	15V	1.4A	21W	○	○	○
	SR20-18	18V	1.2A	21.6W	○	○	Δ
	SR20-20	20V	1.0A	20W	○	○	Δ
	SR20-24	24V	0.9A	21.6W	○	○	○
	SR20-28	28V	0.7A	19.6W	○	○	Δ
SR35	SR35-2	2V	7A	14W	○	○	Δ
	SR35-5	5V	7A	35W	○	○	○
	SR35-6	6V	6A	36W	○	○	Δ
	SR35-9	9V	4A	36W	○	○	Δ
	SR35-12	12V	3A	36W	○	○	○
	SR35-15	15V	2.6A	39W	○	○	○
	SR35-18	18V	2.3A	41.4W	○	○	Δ
	SR35-20	20V	2.1A	42W	○	○	Δ
	SR35-24	24V	1.8A	43.2W	○	○	○
	SR35-28	28V	1.6A	44.8W	○	○	Δ
SR60	SR60-2	2V	12A	24W	○	○	Δ
	SR60-5	5V	12A	60W	○	○	○
	SR60-6	6V	10A	60W	○	○	○
	SR60-9	9V	6.7A	60.3W	○	○	Δ
	SR60-12	12V	5.5A	66W	○	○	○
	SR60-15	15V	4.4A	66W	○	○	○
	SR60-18	18V	3.9A	70.2W	○	○	Δ
	SR60-20	20V	3.9A	78W	○	○	Δ
	SR60-24	24V	3.3A	79.2W	○	○	○
	SR60-28	28V	2.8A	78.4W	○	○	Δ
SR110	SR60-48	48V	1.5A	72W	○	○	Δ
	SR110-2	2V	22A	44W	○	○	Δ
	SR110-5	5V	22A	110W	○	○	○
	SR110-6	6V	19A	114W	○	○	Δ
	SR110-9	9V	13A	117W	○	○	Δ
	SR110-12	12V	10A	120W	○	○	○

Model name	Nominal output voltage	Max. output current	Max. output power	UL	CSA	EN	
SR110	SR110-15	15V	8A	120W	○	○	Δ
	SR110-18	18V	6.5A	117W	○	○	Δ
	SR110-20	20V	6A	120W	○	○	Δ
	SR110-24	24V	5A	120W	○	○	○
	SR110-28	28V	4.2A	117.6W	○	○	Δ
	SR110-48	48V	2.5A	120W	○	○	Δ
SR230	SR230-2	2V	46A	92W	○	○	Δ
	SR230-5	5V	46A	230W	○	○	○
	SR230-6	6V	38A	228W	○	○	○
	SR230-9	9V	25.5A	229.5W	○	○	Δ
	SR230-12	12V	19.5A	234W	○	○	○
	SR230-15	15V	15.5A	232.5W	○	○	Δ
	SR230-18	18V	13A	234W	○	○	Δ
	SR230-20	20V	12A	240W	○	○	Δ
	SR230-24	24V	10A	240W	○	○	○
	SR230-28	28V	8.5A	238W	○	○	Δ
SR330	SR230-48	48V	5A	240W	○	○	Δ
	SR330-2	2V	66A	132W	○	○	Δ
	SR330-5	5V	66A	330W	○	○	○
	SR330-6	6V	55A	330W	○	○	Δ
	SR330-9	9V	37A	333W	○	○	Δ
	SR330-12	12V	28A	336W	○	○	○
	SR330-15	15V	23A	345W	○	○	○
	SR330-18	18V	19A	342W	○	○	Δ
	SR330-20	20V	17A	340W	○	○	○
	SR330-24	24V	15A	360W	○	○	○
	SR330-28	28V	13A	364W	○	○	Δ
	SR330-48	48V	7.5A	360W	○	○	○
SR660	SR660-2	2V	132A	264W	○	○	Δ
	SR660-5	5V	132A	660W	○	○	○
	SR660-6	6V	110A	660W	○	○	Δ
	SR660-9	9V	74A	666W	○	○	Δ
	SR660-12	12V	56A	672W	○	○	○
	SR660-15	15V	45A	675W	○	○	Δ
	SR660-18	18V	37.5A	675W	○	○	Δ
	SR660-20	20V	33A	660W	○	○	Δ
	SR660-24	24V	28A	672W	○	○	○
	SR660-28	28V	24A	672W	○	○	Δ
SR660-48	48V	14A	672W	○	○	Δ	

● Request customer specification for further details of specification, outline, characteristics, etc. Read the instruction manual before usage.
● Contact us about delivery before ordering.

○ : Safety standard approved, Δ : Conforms to safety standard

SR-SERIES

SR20

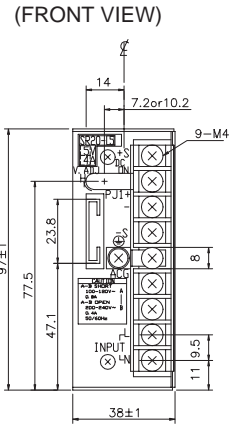
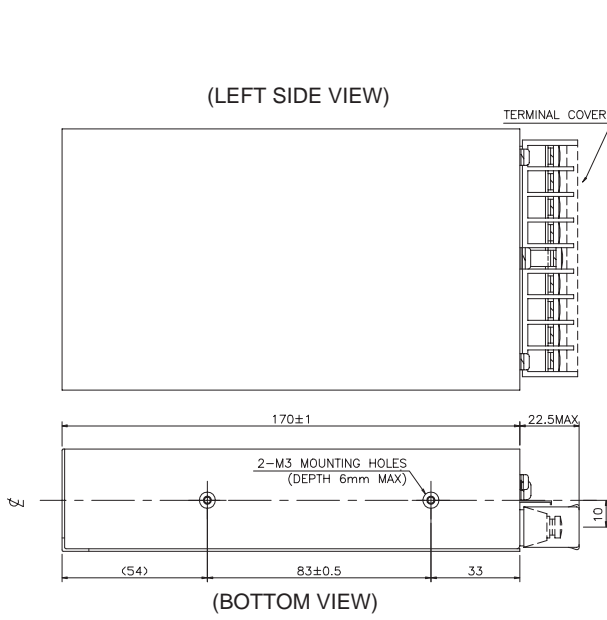

● Recommended Noise Filter

MAW-1201-22



GO!!
P134

(Unit: mm)

SR35

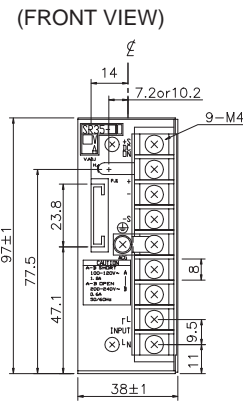
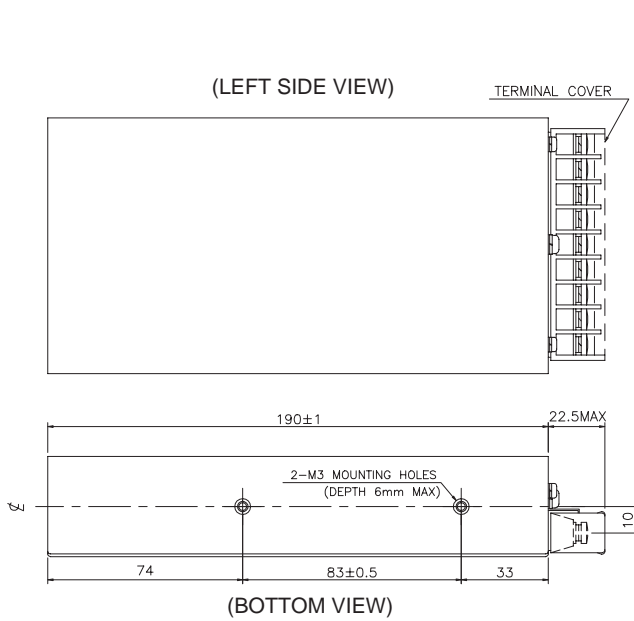

● Recommended Noise Filter

MAW-1202-22



GO!!
P134

(Unit: mm)

SR60

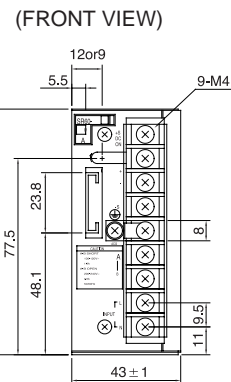
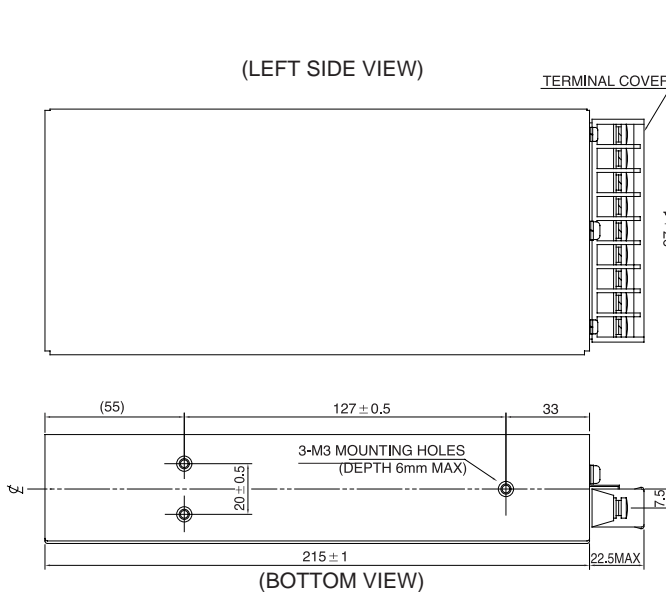

● Recommended Noise Filter

MAW-1203-22



GO!!
P134

(Unit: mm)

SR-SERIES

SR110

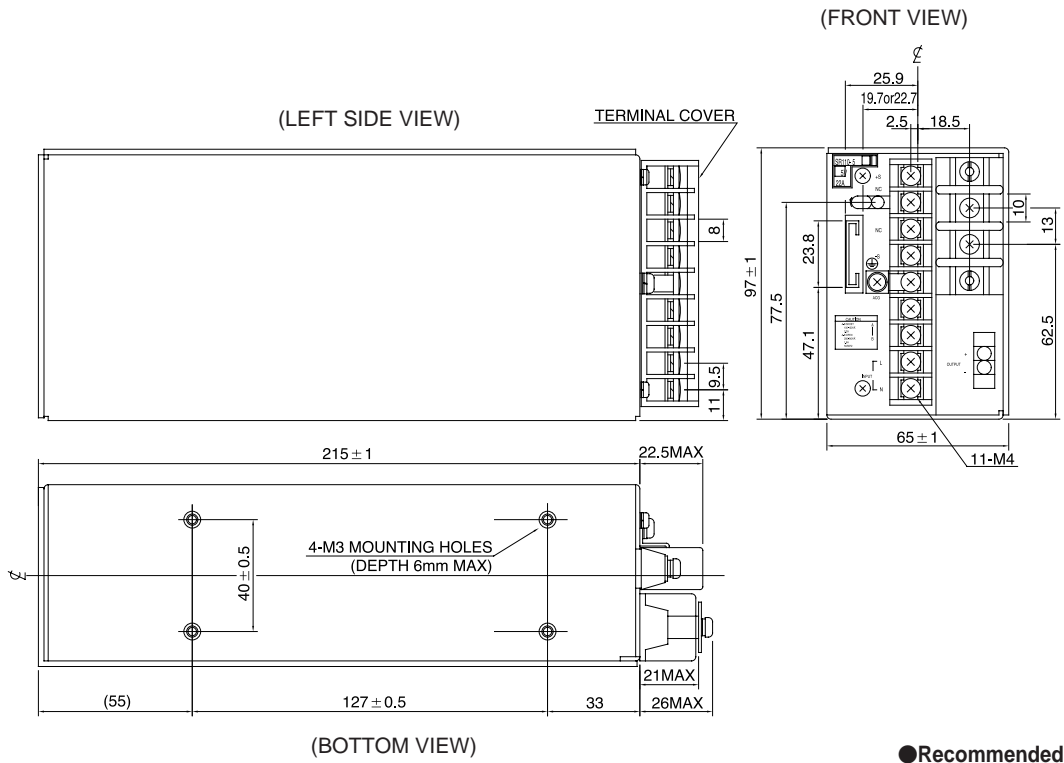

(Unit: mm)

SR230

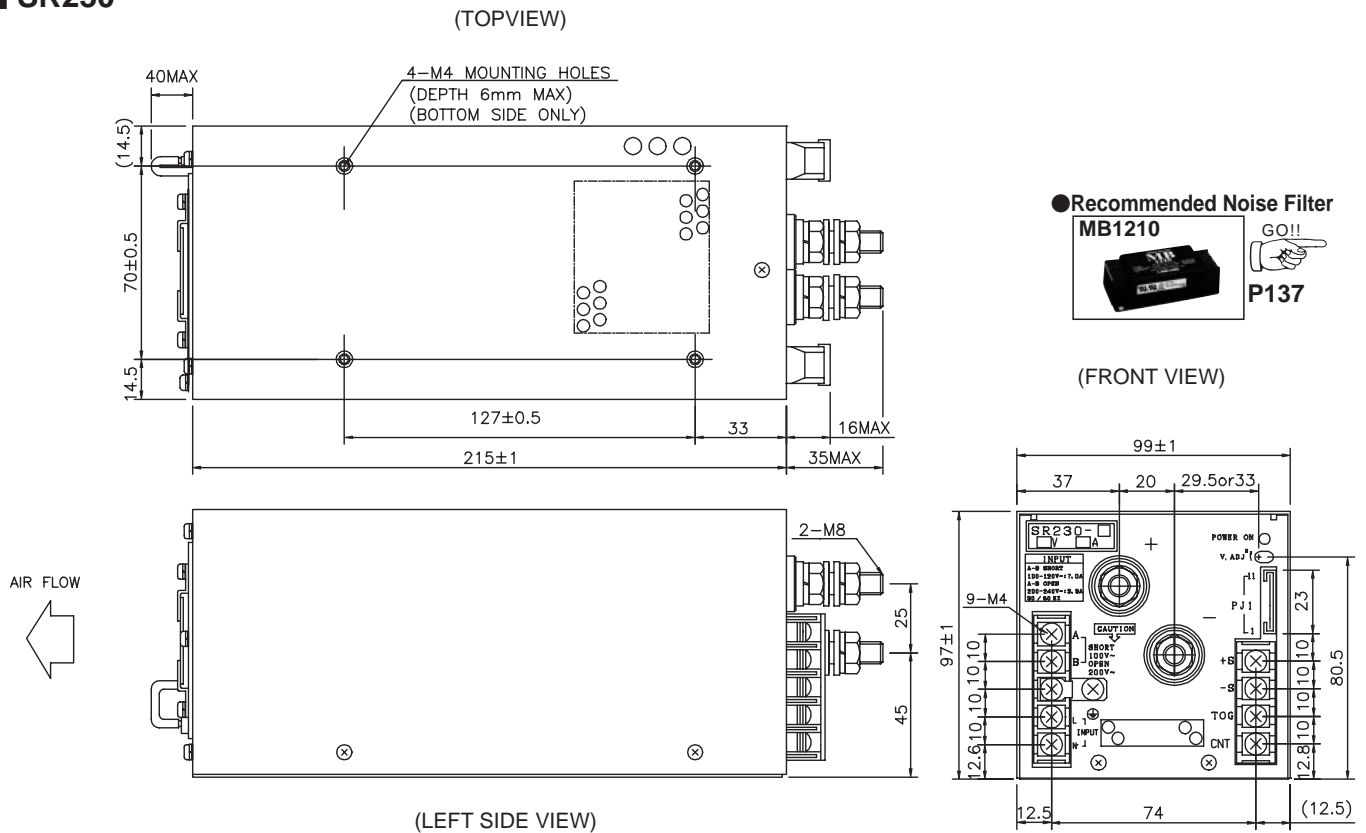

(Unit: mm)

SR-SERIES

Unit Type Power Supply

SR330

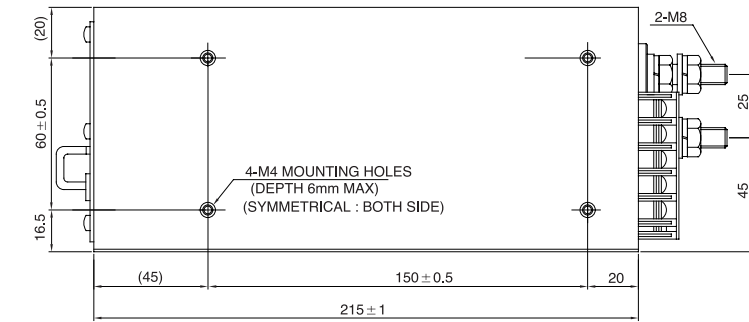
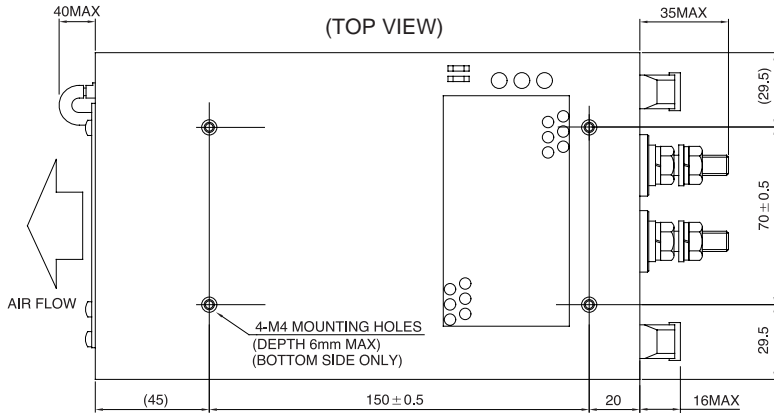

(LEFT SIDE VIEW)

● Recommended Noise Filter



(FRONT VIEW)

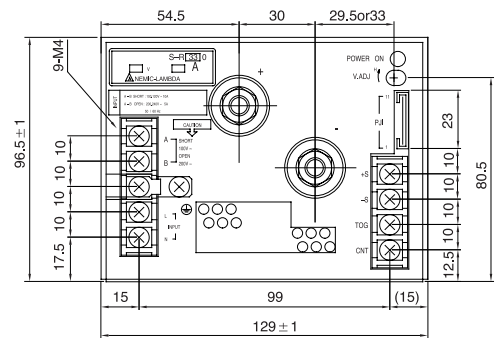

(Unit: mm)

SR660

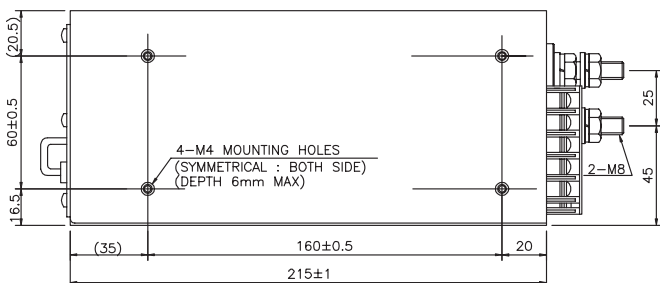
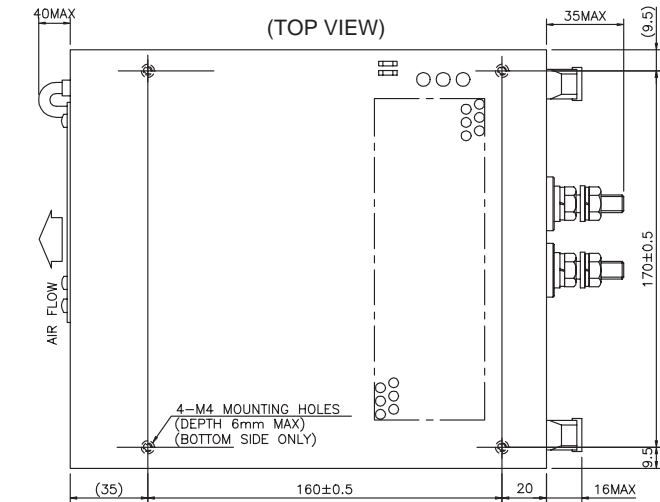

(LEFT SIDE VIEW)

● Recommended Noise Filter



(FRONT VIEW)

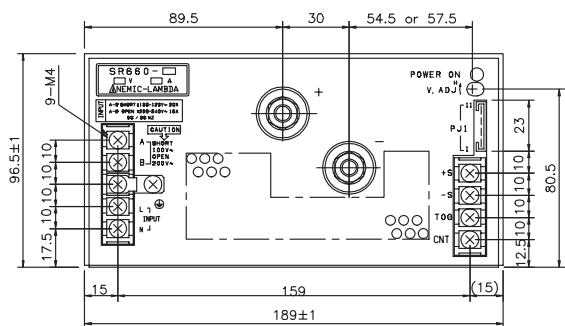

(Unit: mm)