

MC78LXXA/LM78LXXA/MC78L05AA

3-Terminal 0.1A Positive Voltage Regulator

Features

- Maximum Output Current of 100mA
- Output Voltage of 5V, 6V, 8V, 12V, 15V, 18V and 24V
- Thermal Overload Protection
- Short Circuit Current Limiting
- Output Voltage Offered in $\pm 5\%$ Tolerance

Description

The MC78LXXA/LM78LXXA/MC78L05AA series of fixed voltage monolithic integrated circuit voltage regulators are suitable for application that required supply current up to 100mA.

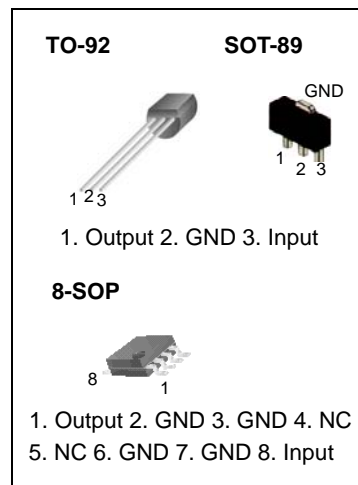

Internal Block Diagram

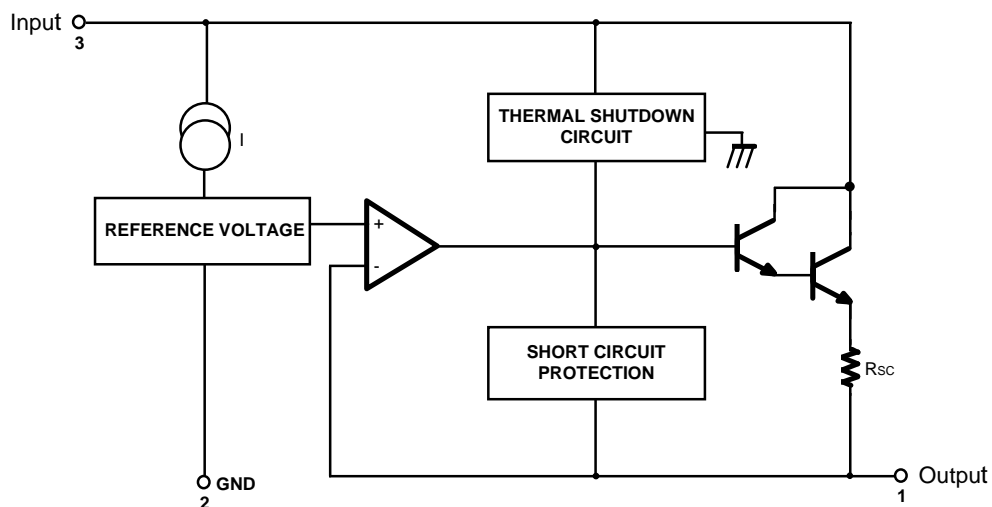

Absolute Maximum Ratings

Parameter	Symbol	Value	Unit
Input Voltage (for $V_O = 5V$ to $8V$) (for $V_O = 12V$ to $18V$) (for $V_O = 24V$)	V_I	30 35 40	V V V
Operating Junction Temperature Range	T_J	0 ~ +150	°C
Storage Temperature Range	T_{STG}	-65 ~ +150	°C
Thermal Resistance Junction-Case TO-92	$R_{\theta JC}$	50	°C/W
Thermal Resistance Junction-Air TO-92 SOT-89 8-SOP	$R_{\theta JA}$	150 225 160	°C/W °C/W °C/W

Electrical Characteristics(MC78L05A/LM78L05A)

($V_I = 10V$, $I_O = 40mA$, $0^\circ C \leq T_J \leq 125^\circ C$, $C_I = 0.33\mu F$, $C_O = 0.1\mu F$, unless otherwise specified. (Note 1))

Parameter	Symbol	Conditions	Min.	Typ.	Max.	Unit	
Output Voltage	V_O	$T_J = 25^\circ C$	4.8	5.0	5.2	V	
Line Regulation (Note1)	ΔV_O	$T_J = 25^\circ C$	$7V \leq V_I \leq 20V$	-	8	150	mV
			$8V \leq V_I \leq 20V$	-	6	100	mV
Load Regulation (Note1)	ΔV_O	$T_J = 25^\circ C$	$1mA \leq I_O \leq 100mA$	-	11	60	mV
			$1mA \leq I_O \leq 40mA$	-	5.0	30	mV
Output Voltage	V_O	$7V \leq V_I \leq 20V$	$1mA \leq I_O \leq 40mA$	-	-	5.25	V
		$7V \leq V_I \leq V_{MAX}$ (Note2)	$1mA \leq I_O \leq 70mA$	4.75	-	5.25	V
Quiescent Current	I_Q	$T_J = 25^\circ C$	-	2.0	5.5	mA	
Quiescent Current Change	With Line	ΔI_Q	$8V \leq V_I \leq 20V$	-	-	1.5	mA
	With Load	ΔI_Q	$1mA \leq I_O \leq 40mA$	-	-	0.1	mA
Output Noise Voltage	V_N	$T_A = 25^\circ C$, $10Hz \leq f \leq 100kHz$	-	40	-	$\mu V/V_O$	
Temperature Coefficient of V_O	$\Delta V_O/\Delta T$	$I_O = 5mA$	-	-0.65	-	mV/°C	
Ripple Rejection	RR	$f = 120Hz$, $8V \leq V_I \leq 18V$, $T_J = 25^\circ C$	41	80	-	dB	
Dropout Voltage	V_D	$T_J = 25^\circ C$	-	1.7	-	V	

Note:

1. The maximum steady state usable output current and input voltage are very dependent on the heat sinking and/or lead length of the package. The data above represent pulse test conditions with junction temperature as indicated at the initiation of tests.
2. Power dissipation $P_D \leq 0.75W$.

Electrical Characteristics(MC78L06A) (Continued)(V_I = 12V, I_O = 40mA, 0°C ≤ T_J ≤ 125°C, C_I = 0.33μF, C_O = 0.1μF, unless otherwise specified. (Note 1))

Parameter	Symbol	Conditions	Min.	Typ.	Max.	Unit	
Output Voltage	V _O	T _J = 25°C	5.75	6.0	6.25	V	
Line Regulation (Note1)	ΔV _O	T _J = 25°C	8.5V ≤ V _I ≤ 20V	-	64	175	mV
			9V ≤ V _I ≤ 20V	-	54	125	mV
Load Regulation (Note1)	ΔV _O	T _J = 25°C	1mA ≤ I _O ≤ 100mA	-	12.8	80	mV
			1mA ≤ I _O ≤ 70mA	-	5.8	40	mV
Output Voltage	V _O	8.5 ≤ V _I ≤ 20V, 1mA ≤ I _O ≤ 40mA	5.7	-	6.3	V	
		8.5 ≤ V _I ≤ V _{MAX} (Note), 1mA ≤ I _O ≤ 70mA	5.7	-	6.3	V	
Quiescent Current	I _Q	T _J = 25°C	-	-	5.5	mA	
		T _J = 125°C	-	3.9	6.0	mA	
Quiescent Current Change	With Line	ΔI _Q	9 ≤ V _I ≤ 20V	-	-	1.5	mA
	With Load	ΔI _Q	1mA ≤ I _O ≤ 40mA	-	-	0.1	mA
Output Noise Voltage	V _N	T _A = 25°C, 10Hz ≤ f ≤ 100kHz	-	40	-	μV/V _O	
Temperature Coefficient of V _O	ΔV _O /ΔT	I _O = 5mA	-	0.75	-	mV/°C	
Ripple Rejection	RR	f = 120Hz, 10V ≤ V _I ≤ 20V, T _J = 25°C	40	46	-	dB	
Dropout Voltage	V _D	T _J = 25°C	-	1.7	-	V	

Note:

1. The maximum steady state usable output current and input voltage are very dependent on the heat sinking and/or lead length of the package. The data above represent pulse test conditions with junction temperature as indicated at the initiation of tests.
2. Power dissipation P_D ≤ 0.75W.

Electrical Characteristics(MC78L08A) (Continued)(V_I = 14V, I_O = 40mA, 0°C ≤ T_J ≤ 125°C, C_I = 0.33μF, C_O = 0.1μF, unless otherwise specified. (Note 1)

Parameter	Symbol	Conditions	Min.	Typ.	Max.	Unit	
Output Voltage	V _O	T _J = 25°C	7.7	8.0	8.3	V	
Line Regulation (Note1)	ΔV _O	T _J = 25°C	10.5V ≤ V _I ≤ 23V	-	10	175	mV
			11V ≤ V _I ≤ 23V	-	8	125	mV
Load Regulation (Note1)	ΔV _O	T _J = 25°C	1mA ≤ I _O ≤ 100mA	-	15	80	mV
			1mA ≤ I _O ≤ 40mA	-	8.0	40	mV
Output Voltage	V _O	10.5V ≤ V _I ≤ 23V	1mA ≤ I _O ≤ 40mA	7.6	-	8.4	V
		10.5V ≤ V _I ≤ V _{MAX} (Note2)	1mA ≤ I _O ≤ 70mA	7.6	-	8.4	V
Quiescent Current	I _Q	T _J = 25°C	-	2.0	5.5	mA	
Quiescent Current Change	With Line	ΔI _Q	11V ≤ V _I ≤ 23V	-	-	1.5	mA
	With Load	ΔI _Q	1mA ≤ I _O ≤ 40mA	-	-	0.1	mA
Output Noise Voltage	V _N	T _A = 25°C, 10Hz ≤ f ≤ 100kHz	-	60	-	μV/V _O	
Temperature Coefficient of V _O	ΔV _O /ΔT	I _O = 5mA	-	-0.8	-	mV/°C	
Ripple Rejection	RR	f = 120Hz, 11V ≤ V _I ≤ 21V, T _J = 25°C	39	70	-	dB	
Dropout Voltage	V _D	T _J = 25°C	-	1.7	-	V	

Note:

1. The maximum steady state usable output current and input voltage are very dependent on the heat sinking and/or lead length of the package. The data above represent pulse test conditions with junction temperature as indicated at the initiation of tests.
2. Power dissipation P_D ≤ 0.75W.

Electrical Characteristics(MC78L12A/LM78L12A) (Continued)(V_I = 19V, I_O = 40mA, 0°C ≤ T_J ≤ 125°C, C_I = 0.33 μF, C_O = 0.1μF, unless otherwise specified. (Note1))

Parameter	Symbol	Conditions	Min.	Typ.	Max.	Unit	
Output Voltage	V _O	T _J = 25°C	11.5	12	12.5	V	
Line Regulation (Note1)	ΔV _O	T _J = 25°C	14.5V ≤ V _I ≤ 27V	-	20	250	mV
			16V ≤ V _I ≤ 27V	-	15	200	mV
Load Regulation (Note1)	ΔV _O	T _J = 25°C	1mA ≤ I _O ≤ 100mA	-	20	100	mV
			1mA ≤ I _O ≤ 40mA	-	10	50	mV
Output Voltage	V _O	14.5V ≤ V _I ≤ 27V	1mA ≤ I _O ≤ 40mA	11.4	-	12.6	V
		14.5V ≤ V _I ≤ V _{MAX} (Note2)	1mA ≤ I _O ≤ 70mA	11.4	-	12.6	V
Quiescent Current	I _Q	T _J = 25°C	-	2.1	6.0	mA	
Quiescent Current Change	With Line	ΔI _Q	16V ≤ V _I ≤ 27V	-	-	1.5	mA
	With Load	ΔI _Q	1mA ≤ I _O ≤ 40mA	-	-	0.1	mA
Output Noise Voltage	V _N	T _A = 25°C, 10Hz ≤ f ≤ 100kHz	-	80	-	μV/V _O	
Temperature Coefficient of V _O	ΔV _O /ΔT	I _O = 5mA	-	-1.0	-	mV/°C	
Ripple Rejection	RR	f = 120Hz, 15V ≤ V _I ≤ 25V, T _J = 25°C	37	65	-	dB	
Dropout Voltage	V _D	T _J = 25°C	-	1.7	-	V	

Note:

1. The maximum steady state usable output current and input voltage are very dependent on the heat sinking and/or lead length of the package. The data above represent pulse test conditions with junction temperature as indicated at the initiation of tests.
2. Power dissipation P_D ≤ 0.75W.

Electrical Characteristics(MC78L15A) (Continued)(V_I = 23V, I_O = 40mA, 0°C ≤ T_J ≤ 125°C, C_I = 0.33 μF, C_O = 0.1μF, unless otherwise specified. (Note1))

Parameter	Symbol	Conditions	Min.	Typ.	Max.	Unit	
Output Voltage	V _O	T _J = 25°C	14.4	15	15.6	V	
Line Regulation (Note1)	ΔV _O	T _J = 25°C	17.5V ≤ V _I ≤ 30V	-	25	300	mV
			20V ≤ V _I ≤ 30V	-	20	250	mV
Load Regulation (Note1)	ΔV _O	T _J = 25°C	1mA ≤ I _O ≤ 100mA	-	25	150	mV
			1mA ≤ I _O ≤ 40mA	-	12	75	mV
Output Voltage	V _O	17.5V ≤ V _I ≤ 30V	1mA ≤ I _O ≤ 40mA	14.25	-	15.75	V
		17.5V ≤ V _I ≤ V _{MAX} (Note2)	1mA ≤ I _O ≤ 70mA	14.25	-	15.75	V
Quiescent Current	I _Q	T _J = 25°C	-	2.1	6.0	mA	
Quiescent Current Change	With Line	ΔI _Q	20V ≤ V _I ≤ 30V	-	-	1.5	mA
	With Load	ΔI _Q	1mA ≤ I _O ≤ 40mA	-	-	0.1	mA
Output Noise Voltage	V _N	T _A = 25°C, 10Hz ≤ f ≤ 100kHz	-	90	-	μV/V _O	
Temperature Coefficient of V _O	ΔV _O /ΔT	I _O = 5mA	-	-1.3	-	mV/°C	
Ripple Rejection	RR	f = 120Hz, 18.5V ≤ V _I ≤ 28.5V, T _J = 25°C	34	60	-	dB	
Dropout Voltage	V _D	T _J = 25°C	-	1.7	-	V	

Note:

1. The maximum steady state usable output current and input voltage are very dependent on the heat sinking and/or lead length of the package. The data above represent pulse test conditions with junction temperature as indicated at the initiation of tests.
2. Power dissipation P_D ≤ 0.75W.

Electrical Characteristics(MC78L18A) (Continued)(V_I = 27V, I_O = 40mA, 0°C ≤ T_J ≤ 125°C, C_I = 0.33μF, C_O = 0.1μF, unless otherwise specified. (Note1))

Parameter	Symbol	Conditions	Min.	Typ.	Max.	Unit	
Output Voltage	V _O	T _J = 25°C	17.3	18	18.7	V	
Line Regulation (Note1)	ΔV _O	T _J = 25°C	21V ≤ V _I ≤ 33V	-	145	300	mV
			22V ≤ V _I ≤ 33V	-	135	250	mV
Load Regulation (Note1)	ΔV _O	T _J = 25°C	1mA ≤ I _O ≤ 100mA	-	30	170	mV
			1mA ≤ I _O ≤ 40mA	-	15	85	mV
Output Voltage	V _O	21V ≤ V _I ≤ 33V	1mA ≤ I _O ≤ 40mA	17.1	-	18.9	V
		21V ≤ V _I ≤ V _{MAX} (Note2)	1mA ≤ I _O ≤ 70mA	17.1	-	18.9	V
Quiescent Current	I _Q	T _J = 25°C	-	2.2	6.0	mA	
Quiescent Current Change	With Line	ΔI _Q	21V ≤ V _I ≤ 33V	-	-	1.5	mA
	With Load	ΔI _Q	1mA ≤ I _O ≤ 40mA	-	-	0.1	mA
Output Noise Voltage	V _N	T _A = 25°C, 10Hz ≤ f ≤ 100kHz	-	150	-	μV/V _O	
Temperature Coefficient of V _O	ΔV _O /ΔT	I _O = 5mA	-	-1.8	-	mV/°C	
Ripple Rejection	RR	f = 120Hz, 23V ≤ V _I ≤ 33V, T _J = 25°C	34	48	-	dB	
Dropout Voltage	V _D	T _J = 25°C	-	1.7	-	V	

Note:

1. The maximum steady state usable output current and input voltage are very dependent on the heat sinking and/or lead length of the package. The data above represent pulse test conditions with junction temperature as indicated at the initiation of tests.
2. Power dissipation P_D ≤ 0.75W.

Electrical Characteristics(MC78L24A) (Continued)(V_I = 33V, I_O = 40mA, 0°C ≤ T_J ≤ 125°C, C_I = 0.33μF, C_O = 0.1μF, unless otherwise specified. (Note1))

Parameter	Symbol	Conditions	Min.	Typ.	Max.	Unit	
Output Voltage	V _O	T _J = 25°C	23	24	25	V	
Line Regulation (Note1)	ΔV _O	T _J = 25°C	27V ≤ V _I ≤ 38V	-	160	300	mV
			28V ≤ V _I ≤ 38V	-	150	250	mV
Load Regulation (Note1)	ΔV _O	T _J = 25°C	1mA ≤ I _O ≤ 100mA	-	40	200	mV
			1mA ≤ I _O ≤ 40mA	-	20	100	mV
Output Voltage	V _O	27V ≤ V _I ≤ 38V	1mA ≤ I _O ≤ 40mA	22.8	-	25.2	V
		27V ≤ V _I ≤ V _{MAX} (Note2)	1mA ≤ I _O ≤ 70mA	22.8	-	25.2	V
Quiescent Current	I _Q	T _J = 25°C	-	2.2	6.0	mA	
Quiescent Current Change	With Line	ΔI _Q	28V ≤ V _I ≤ 38V	-	-	1.5	mA
	With Load	ΔI _Q	1mA ≤ I _O ≤ 40mA	-	-	0.1	mA
Output Noise Voltage	V _N	T _A = 25°C, 10Hz ≤ f ≤ 100kHz	-	200	-	μV/V _O	
Temperature Coefficient of V _O	ΔV _O /ΔT	I _O = 5mA	-	-2.0	-	mV/°C	
Ripple Rejection	RR	f = 120Hz, 28V ≤ V _I ≤ 38V, T _J = 25°C	34	45	-	dB	
Dropout Voltage	V _D	T _J = 25°C	-	1.7	-	V	

Note:

1. The maximum steady state usable output current and input voltage are very dependent on the heat sinking and/or lead length of the package. The data above represent pulse test conditions with junction temperature as indicated at the initiation of tests.
2. Power dissipation P_D ≤ 0.75W.

Absolute Maximum Ratings

Parameter	Symbol	Value	Unit
Input Voltage (for $V_O = 5V$ to $8V$) (for $V_O = 12V$ to $18V$) (for $V_O = 24V$)	V_I	30	V
		35	V
		40	V
Operating Junction Temperature Range	T_J	0 ~ +150	°C
Storage Temperature Range	T_{STG}	-65 ~ +150	°C

Electrical Characteristics(MC78L05AA) (Continued)

($V_I = 10V$, $I_O = 40mA$, $0^\circ C \leq T_J \leq 125^\circ C$, $C_I = 0.33\mu F$, $C_O = 0.1\mu F$, unless otherwise specified. (Note))

Parameter	Symbol	Conditions	Min.	Typ.	Max.	Unit	
Output Voltage	V_O	$T_J = 25^\circ C$	4.9	5.0	5.1	V	
Line Regulation (Note1)	ΔV_O	$T_J = 25^\circ C$	$7V \leq V_I \leq 20V$	-	8	150	mV
			$8V \leq V_I \leq 20V$	-	6	100	mV
Load Regulation (Note1)	ΔV_O	$T_J = 25^\circ C$	$1mA \leq I_O \leq 100mA$	-	11	50	mV
			$1mA \leq I_O \leq 40mA$	-	5.0	25	mV
Output Voltage	V_O	$7V \leq V_I \leq 20V$	$1mA \leq I_O \leq 40mA$	-	-	5.15	V
		$7V \leq V_I \leq V_{MAX}$ (Note2)	$1mA \leq I_O \leq 70mA$	4.75	-	5.15	V
Quiescent Current	I_Q	$T_J = 25^\circ C$	-	2.0	5.5	mA	
Quiescent Current Change	With Line	ΔI_Q	$8V \leq V_I \leq 20V$	-	-	1.5	mA
	With Load	ΔI_Q	$1mA \leq I_O \leq 40mA$	-	-	0.1	mA
Output Noise Voltage	V_N	$T_A = 25^\circ C$, $10Hz \leq f \leq 100kHz$	-	40	-	$\mu V/V_O$	
Temperature Coefficient of V_O	$\Delta V_O/\Delta T$	$I_O = 5mA$	-	-0.65	-	mV/°C	
Ripple Rejection	RR	$f = 120Hz$, $8V \leq V_I \leq 18V$, $T_J = 25^\circ C$	41	80	-	dB	
Dropout Voltage	V_D	$T_J = 25^\circ C$	-	1.7	-	V	

Note:

1. The maximum steady state usable output current and input voltage are very dependent on the heat sinking and/or lead length of the package. The data above represent pulse test conditions with junction temperature as indicated at the initiation of tests.
2. Power dissipation $P_D \leq 0.75W$.

Typical Application

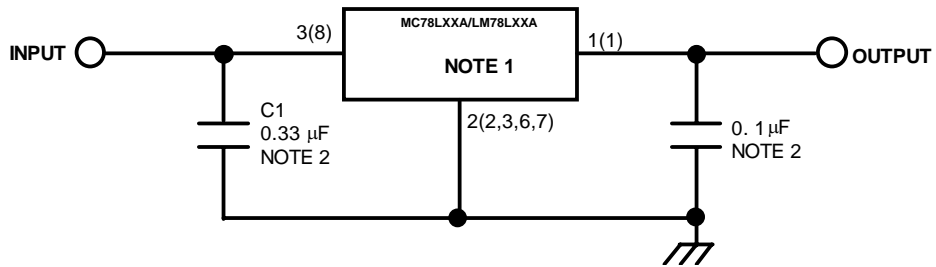

'()' : 8SOP Type

Notes:

1. To specify an output voltage, substitute voltage value for "XX".
2. Bypass Capacitors are recommend for optimum stability and transient response and should be located as close as possible to the regulator

Mechanical Dimensions

Package

Dimensions in millimeters

TO-92 Straight Lead for Bulk Packing

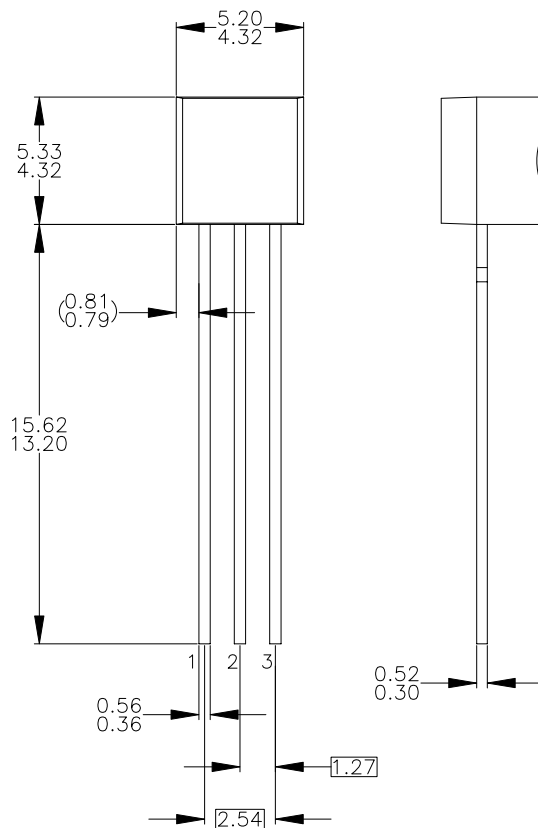

NOTES: UNLESS OTHERWISE SPECIFIED

- A) DRAWING WITH REFERENCE TO JEDEC TO-92 RECOMMENDATIONS.
- B) ALL DIMENSIONS ARE IN MILLIMETERS.
- C) DRAWING CONFORMS TO ASME Y14.5M-1994.

Mechanical Dimensions (Continued)

Package

Dimensions in millimeters

TO-92 Formed Lead For T&R and Ammo Packing

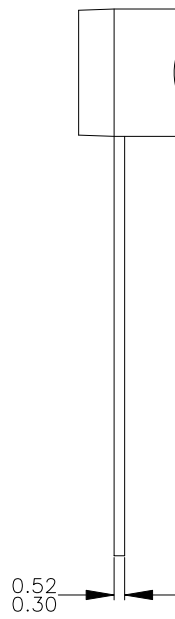
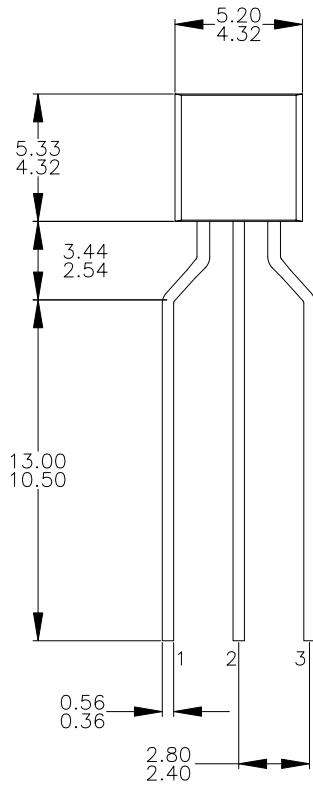

NOTES: UNLESS OTHERWISE SPECIFIED

- A) DRAWING WITH REFERENCE TO JEDEC TO-92 RECOMMENDATIONS.
- B) ALL DIMENSIONS ARE IN MILLIMETERS.
- C) DRAWING CONFORMS TO ASME Y14.5M-1994.

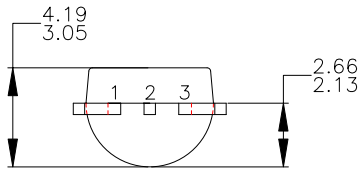

Mechanical Dimensions (Continued)

Package

Dimensions in millimeters

8-SOP

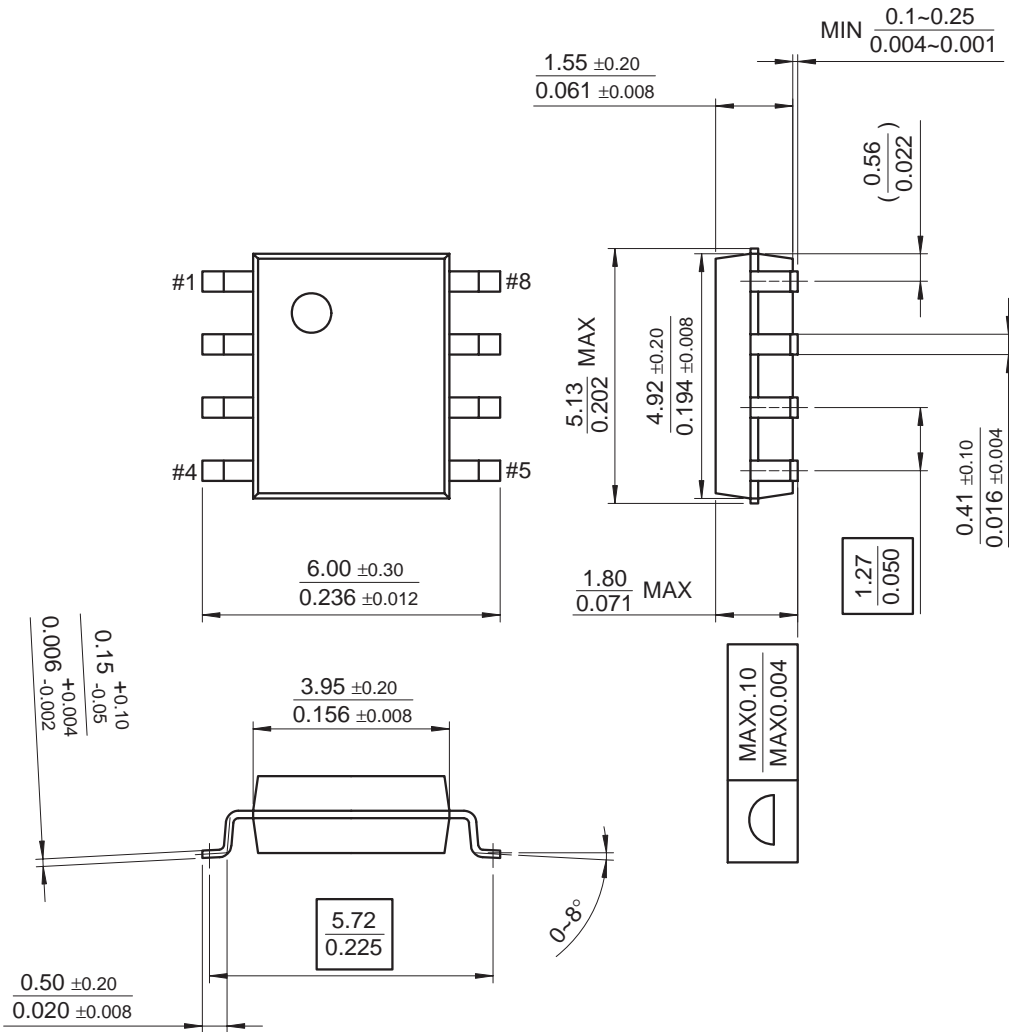

Mechanical Dimensions (Continued)

Package

Dimensions in millimeters

SOT-89

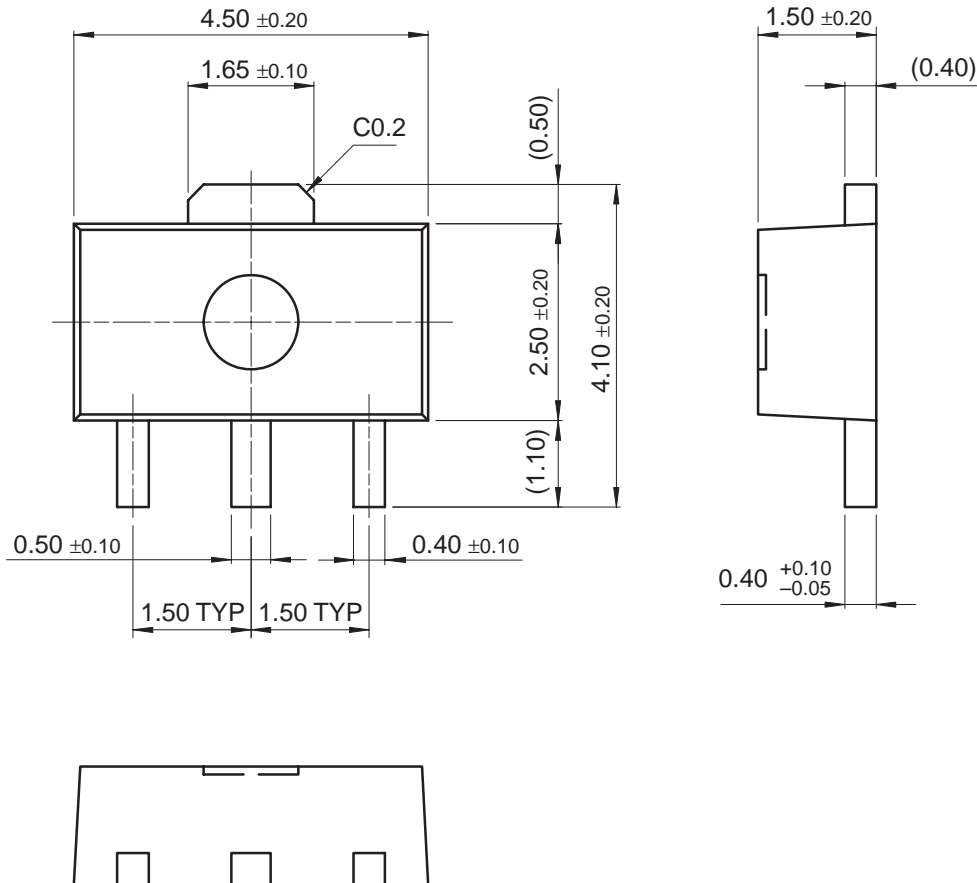

Ordering Information

Product Number	Package	Output Voltage Tolerance	Operating Temperature
LM78L05ACZ	TO-92	5%	0 ~ +125°C
LM78L12ACZ			
Product Number	Package	Output Voltage Tolerance	Operating Temperature
MC78L05ACP	TO-92	5%	0 ~ +125°C
MC78L06ACP			
MC78L08ACP			
MC78L12ACP			
MC78L15ACP			
MC78L18ACP			
MC78L24ACP			
MC78L05ACD	8-SOP	5%	0 ~ +125°C
MC78L08ACD			
MC78L12ACD			
MC78L05ACH	SOT-89	5%	0 ~ +125°C
MC78L08ACH			
MC78L12ACH			
MC78L05AACP	TO-92	2%	

DISCLAIMER

FAIRCHILD SEMICONDUCTOR RESERVES THE RIGHT TO MAKE CHANGES WITHOUT FURTHER NOTICE TO ANY PRODUCTS HEREIN TO IMPROVE RELIABILITY, FUNCTION OR DESIGN. FAIRCHILD DOES NOT ASSUME ANY LIABILITY ARISING OUT OF THE APPLICATION OR USE OF ANY PRODUCT OR CIRCUIT DESCRIBED HEREIN; NEITHER DOES IT CONVEY ANY LICENSE UNDER ITS PATENT RIGHTS, NOR THE RIGHTS OF OTHERS.

LIFE SUPPORT POLICY

FAIRCHILD'S PRODUCTS ARE NOT AUTHORIZED FOR USE AS CRITICAL COMPONENTS IN LIFE SUPPORT DEVICES OR SYSTEMS WITHOUT THE EXPRESS WRITTEN APPROVAL OF THE PRESIDENT OF FAIRCHILD SEMICONDUCTOR CORPORATION. As used herein:

1. Life support devices or systems are devices or systems which, (a) are intended for surgical implant into the body, or (b) support or sustain life, and (c) whose failure to perform when properly used in accordance with instructions for use provided in the labeling, can be reasonably expected to result in a significant injury of the user.
2. A critical component in any component of a life support device or system whose failure to perform can be reasonably expected to cause the failure of the life support device or system, or to affect its safety or effectiveness.