

MAX7044 Evaluation Kit

Evaluates: MAX7044

General Description

The MAX7044 evaluation kit (EV kit) contains a single MAX7044 crystal-referenced phase-locked-loop (PLL) VHF/UHF transmitter designed to transmit OOK/ASK data in the 300MHz to 450MHz frequency range.

The EV kit operates alone or in conjunction with an external microcontroller (MCU) and graphical user interface (GUI) software running on a computer.

The EV kit is designed to facilitate the operation of the transmitter and provide tools for generating a data stream with a simple, one-pin data interface to the MAX7044. This EV kit is preconfigured to operate at two frequencies (315MHz or 433MHz) based on the crystal selection and the output network.

The EV kit includes Windows® 10-compatible software that provides a simple GUI that controls the on-board PMIC and can act as a data generator when the MAX32630FTHR applications platform is used.

Features and Benefits

- Evaluates the MAX7044 OOK/ASK Sub-1GHz ISM Band Transmitter
- Single Input Voltage Supply from +2.1V to +3.6V
- Direct Interface with a MAX32630FTHR Arm® Microcontroller (MCU) Board
- Available PMOD Hardware Interface
- Windows 10-Compatible Software
- GUI Controls for MAX32630FTHR Board PMIC Operation from 2.1V to 3.3V
- Proven Two-Layer PCB Design
- Fully Assembled and Tested

[Ordering Information](#) appears at end of data sheet.

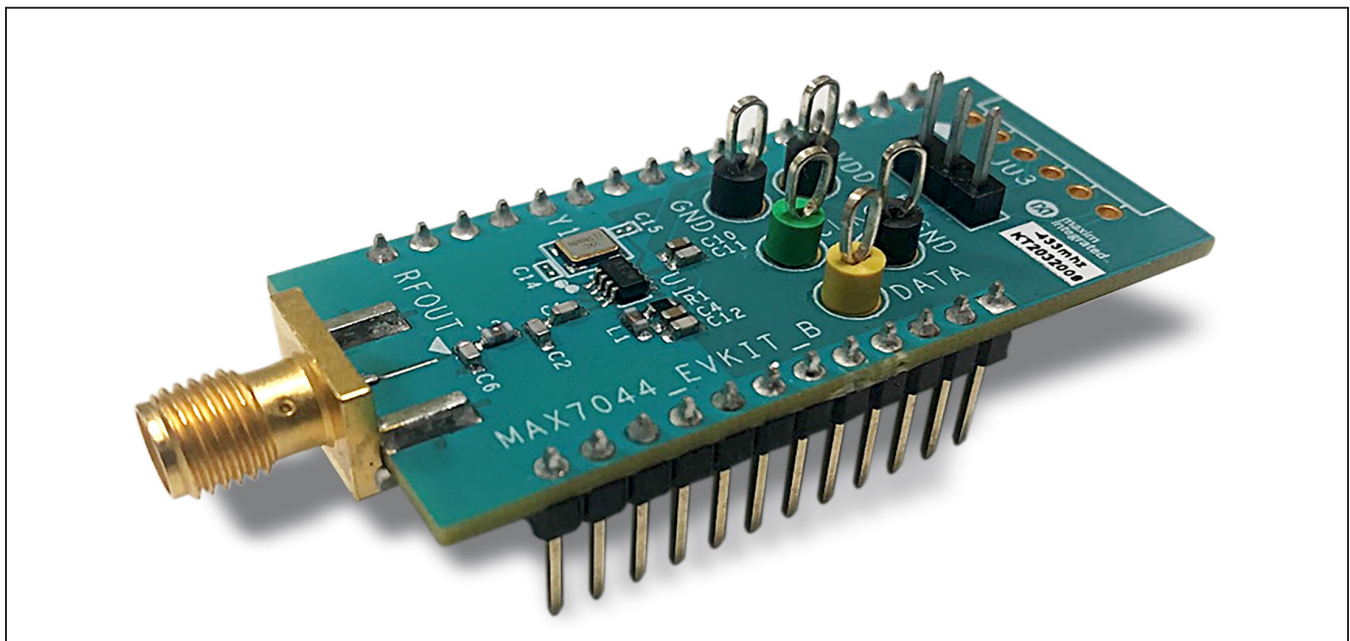

Figure 1. MAX7044 EV Kit Board

Windows is a registered trademark and registered service mark of Microsoft Corporation.

Arm and Cortex are registered trademarks of Arm Limited (or its subsidiaries) in the US and/or elsewhere.

Quick Start

Required Equipment

- **Included in the MAX7044 EV Kit**
 - MAX7044 EV Kit Board
 - MAX32630FTHR# Kit
 - FTHR Board
 - DAPLINK Board
 - 2x Micro-B USB Cables
- Windows PC* (Windows 7/Windows 10), with One to Two USB 2.0 Ports Available
- Power Supply† Capable of 2.1V to 3.6V, 100mA
- Serial Data Source† and a Simple Means of Connection (DATA Test Point and Ground)
- Basic Spectrum Analyzer – Rohde & Schwarz ZVL3, Tektronix® RSA306, or Equivalent
- SMA/SMA Cable as Needed for Connection to the Spectrum Analyzer

Software and Drivers

The EV kit can be used in conjunction with the Arm® Cortex®-M4F microcontroller MAX32630FTHR application Platform, or **FTHR** board, to provide power and tools to operate the device through a software application or GUI. For this option, additional equipment is required.

When connected to the FTHR board, the EV kit uses the following drivers and software components. See [Appendix I](#) for additional information on this installation process.

- **MAX7044 Software Package**

The software, firmware, and drivers are available from the www.maximintegrated.com website. Log in to your My Maxim account on the website, search for the MAX7044 IC or EV kit, click on the **Design Resources** tab, and click on the appropriate software link. Finally, click the file link on the software landing page to download the MAX7044 EV kit package.

- **Mbed® MAX32630FTHR and DAPLINK Interface System**

The DAPLINK system should not be required unless a firmware update to the FTHR board has been released. The FTHR board included in the EV kit will be preprogrammed for interfacing the GUI to the radio. The firmware programming process does not require

additional software or drivers, it uses a simple USB drive, drag-and-drop file interface.

It is highly recommended that the target PC be connected to a local area network and have access to the Internet, this allows for automatic download and updates of some drivers. This process may take 15 minutes or more to complete.

Installation Procedure

The steps in this section are used when connecting the EV kit to a FTHR board and should only be needed once, when configuring the hardware and the PC for the first time. If these steps have already been completed, see the [FTHR Board Quick Start Procedure](#).

Install the MAX7044 EV Kit GUI Software

This process should take less than 10 minutes after downloading the software package. See [Appendix I](#) for detailed information on this installation process.

- 1) Download the ISM Radios GUI software. Copy the **Setup MAX7044 V1.0.0 EVKit SW.rar** file to a working folder on the target PC.
- 2) Double-click the **ISMRadiosGUISetup.msi** setup file and follow the Setup Wizard prompts.
 - a. Click **Next** in the ISM Radios GUI Setup Wizard window.
 - b. It is recommended to use the default Destination Folder; click **Next** to continue.
 - c. Install the software by clicking the **Install** button.
 - d. Click **Finish** when the ISM Radios GUI Setup Wizard installation process is complete.

Update the MAX32630FTHR Board Driver on the Host PC

No changes are needed for the FTHR board when first receiving a MAX7044EVKIT—the FTHR board has been preloaded with the required firmware. Updates to the driver on the host PC may be necessary depending on the operating system and whether the PC has access to the internet when first connecting to the FTHR board. See [Appendix I](#) for detailed information on how to update the FTHR board firmware and the driver for the FTHR board/USB interface.

*Required for operation of the MAX7044 EV Kit with the GUI software

†Required when the FTHR board is not connected to the MAX7044 EV Kit

Tektronix is a registered trademarks of Tektronix, Inc.

Mbed is a trademark of Arm Limited (or its subsidiaries) in the US and/or elsewhere

Table 1. MAX7044 EV Kit Installed Files and Folders

FILE NAME	DESCRIPTION
ISMRadiosGUISetup.msi	Application GUI
MaximStyle.dll	Supporting DLL file for software operation
MAX4147X_Registers.xml*	Register definition file for MAX4147X
MAX4146X_Registers.xml*	Register definition file for MAX4146X
MAX1471_Registers.xml*	Register definition file for MAX1471
MAX7032_Registers.xml*	Register definition file for MAX7032
MAX4147X_QuickStart.xml*	Quick start configuration file for MAX4147X
MAX1471_QuickStart.xml*	Quick start configuration file for MAX1471
MAX7032_RxQuickStart.xml	Quick start configuration file for MAX7032 receive
MAX7032 TxQuickStart.xml	Quick start configuration file for MAX7032 transmit
Firmware	Folder for current FW at the time of GUI download

*Not used in this evaluation, but provided with the common platform.

Hardware Use Procedure

Table 2. MAX7044 EV Kit Jumper Settings

JUMPERS	POSITION	EV KIT FUNCTION
JU4	1-2	Power from L3OUT (FTHR board: 3.3V)
	2-3	Power from PMOD interface (V _{DD} , pin 6 of JU3 (DNP))
	Not Installed*	Power from external source on VDD and GND test points

*Default position

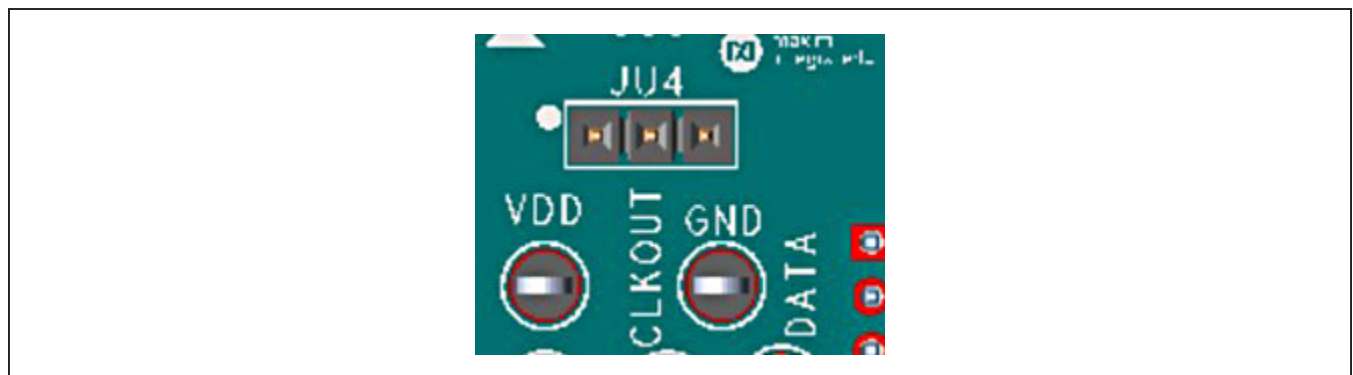

Figure 2. MAX7044 EV kit Jumpers

FTHR Board Quick Start Procedure – SPI and I²C Interface

Set Up the MAX7044 EV Kit and FTHR Board Hardware MCU/GUI Operation

- 1) Verify that all jumpers on the MAX7044 EV kit board are in the default position; see [Table 2](#).
- 2) Connect the EV kit to the FTHR board, be sure the USB connector is oriented on the opposite side of the SMA connector as shown in [Figure 3](#).
- 3) Connect the FTHR board to the PC using a Micro-B USB cable and observe a **heartbeat** on the FTHR board's red LED.
- 4) Connect the RF_OUT to a spectrum analyzer using a low-loss SMA cable.
 - a. Set the Center Frequency to the target frequency of interest.

- b. Set the Span to 1% of the Center Frequency (FCC standard test setting), the Resolution Bandwidth (RBW) to 1kHz, and the Video Bandwidth (VBW) to 3kHz.
 - c. Set the trace to Max Hold.
- 5) Start the MAX7044 EV kit Control Software GUI.
 - a. An ISM Radio GUI splash screen as shown in [Figure 4](#) will be displayed.
 - i. To disable future displays of the splash screen, click on the **Disable** check box.
 - ii. To continue to the GUI software, click on the **OK** button.
 - iii. Select the MAX7044-Tx from the **Device** drop-down menu as shown in [Figure 6](#).

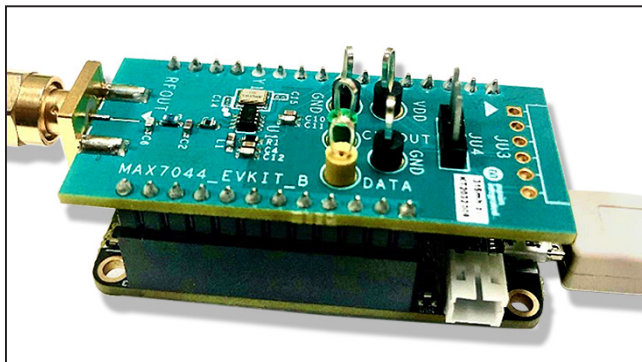

Figure 3. MAX7044 EV kit Orientation to the FTHR Board

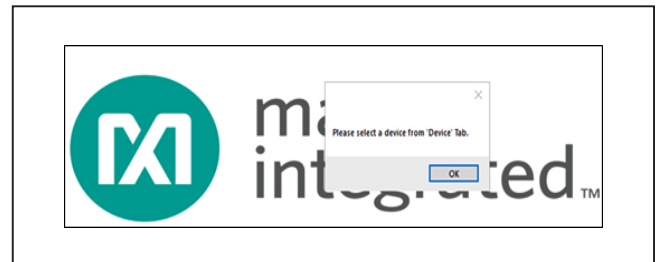

Figure 5. ISM Radios GUI Device Select Screen

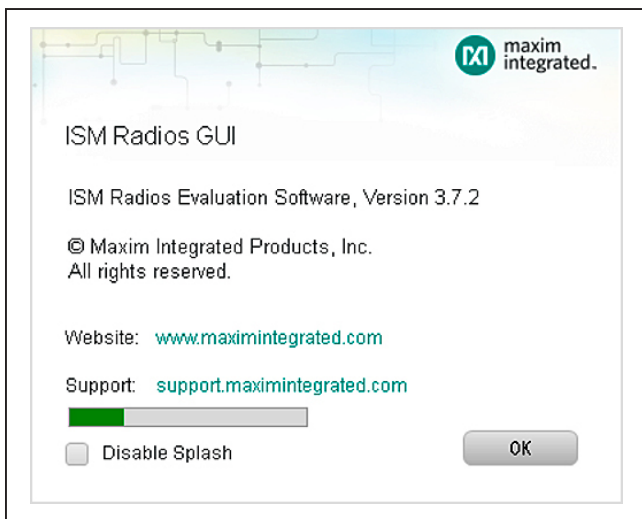

Figure 4. ISM Radios GUI Splash Screen



Figure 6. ISM Radios GUI Device Select Screen

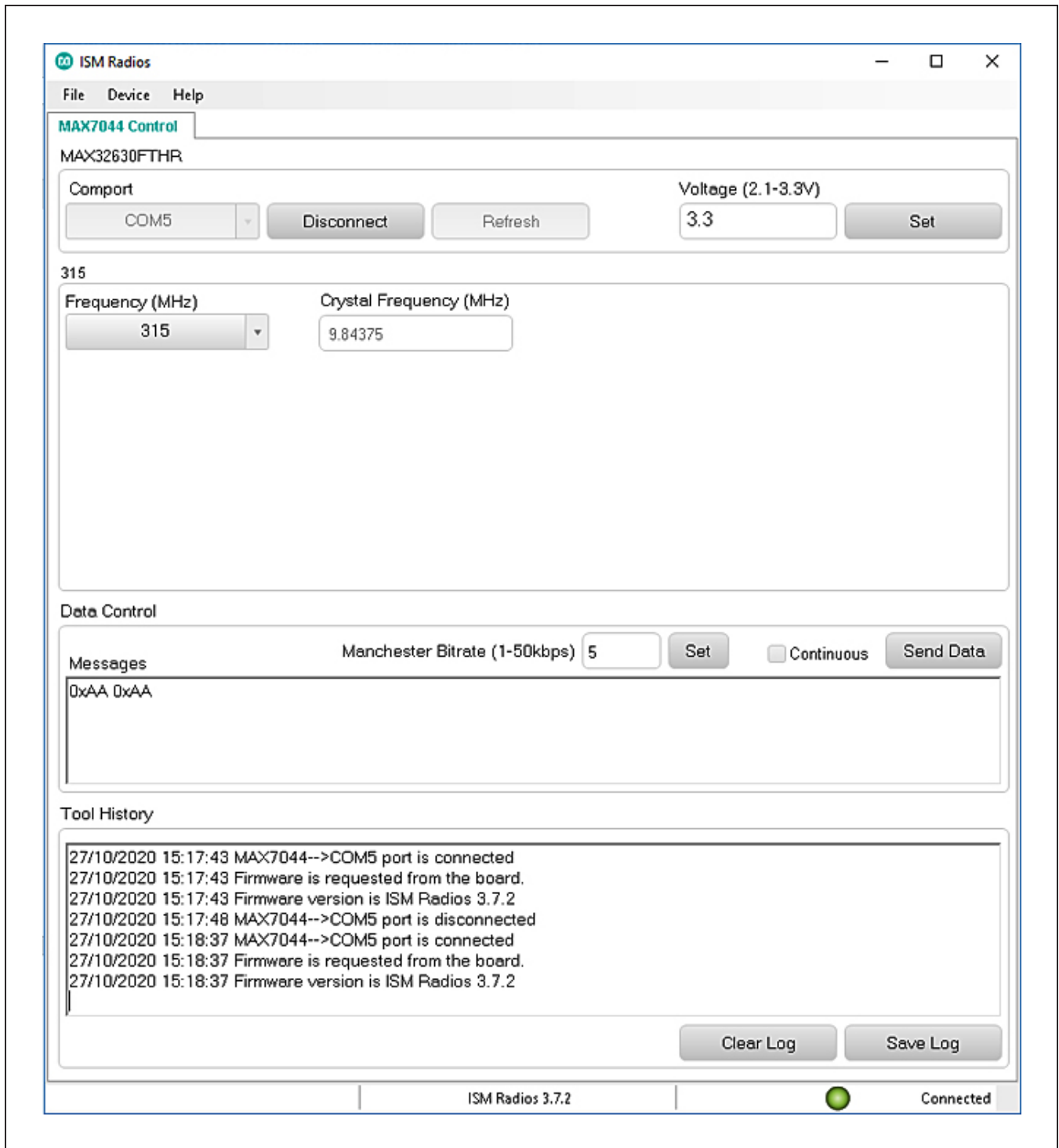

Figure 7. ISM Radio GUI Software

- b. The expected COM port should be displayed if the EV kit was connected prior to starting the GUI. Select the appropriate COM port from the drop-down list and click on the **Connect** button. The **Connect** button will change to the **Disconnect** button.
 - c. Confirm the firmware status bar has changed from **ISM Radios x.x.x** to **ISM Radios 6.0.0** or similar, the software LED is lit green, and the port status is noted as **Connected**.
 - d. Enter a supply level into the **Voltage** text box and click the **Set** button; for example, enter **3.0** for a 3.0V supply and click **Set**.
- 6) Generate a transmission.
- a. In the **Data Control** block, enter a Manchester bitrate of interest and click the **Set** button.
 - b. Enter 0xAA in the **Messages** text box in the **Data Control** block.
- c. Check the **Continuous** checkbox.
 - d. Click on the **Send Data** button, the button will change to **Stop**.
- 7) Observe the output on the spectrum analyzer.
- a. Connect the **RF_OUT** to a spectrum analyzer using a low-loss SMA cable and configure the equipment.
 - b. Set the **Center Frequency** to the same value as selected with the jumpers in step 1.
 - c. Set the **Span** to 1% of the Center Frequency, the Resolution Bandwidth (RBW) to 1kHz, and the Video Bandwidth (VBW) to 3kHz.
 - d. Set the **trace** to Max Hold.
- 8) Observe the **RF output** on the spectrum analyzer.

Table 3. MAX7044EVKIT Test Points

NAME	COLOR	EV KIT FUNCTION
VDD	Black	2.1V to 3.6V power supply pin
GND	Black	Ground
DATAIN/SDI	Yellow	TX data
CLKOUT/SDO	Green	Clock output



Figure 8. COM Port

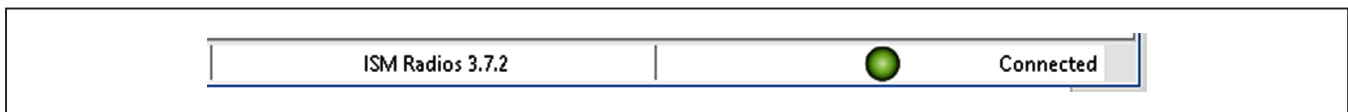

Figure 9. Connected Indicators

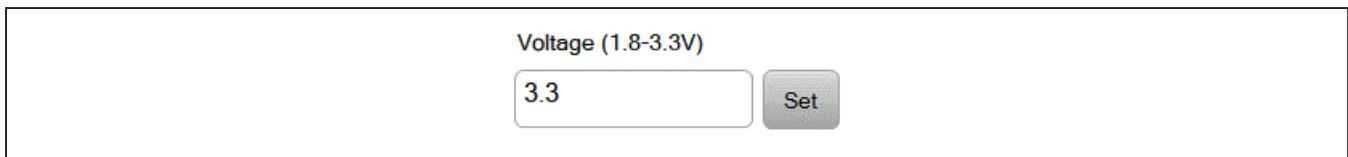

Figure 10. Supply Voltage

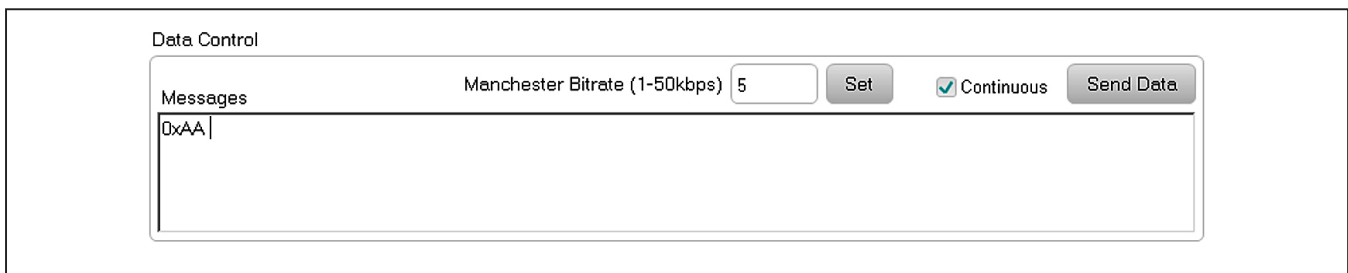

Figure 11. Data Control Block

Detailed Description

Detailed Description of Hardware

MAX7044 EV kit Printed Circuit Board

The MAX7044 EV kit PCB is manufactured on a two-layer, 1oz copper, FR4 dielectric stack-up PCB. Layer 1 is primarily designed to keep the RF signals on one side of the board with short traces, small matching components, and low parasitics. Layer 2 is targeted to be a continuous ground plane wherever possible. The EV kit is available in two versions: 315MHz (MAX7044EVKIT-315) and 433.92MHz (MAX7044EVKIT-433). The passive components are optimized for these two frequencies, but can easily be changed to work at RF frequencies anywhere from 300MHz to 450MHz.

Power

The EV kit board can be powered directly from the FTNR board PMIC through the H1 header, directly from the supply test points, or through the user-installed PMOD header. The FTNR board can provide a supply from +2.1V to +3.3V or a single +2.1V to +3.6V, 100mA power supply can be connected to the board using the two wire loops (marked VDD and GND). Jumper JU4 selects the source of power when not using the direct connection test points: from the L3OUT of the FTNR board or the PVIO of the PMOD connector.

Data Interface

The EV kit comes preconfigured to directly connect the FTNR board through the H1/H2 headers. The GUI controls the communication of the FTNR board and MAX7044.

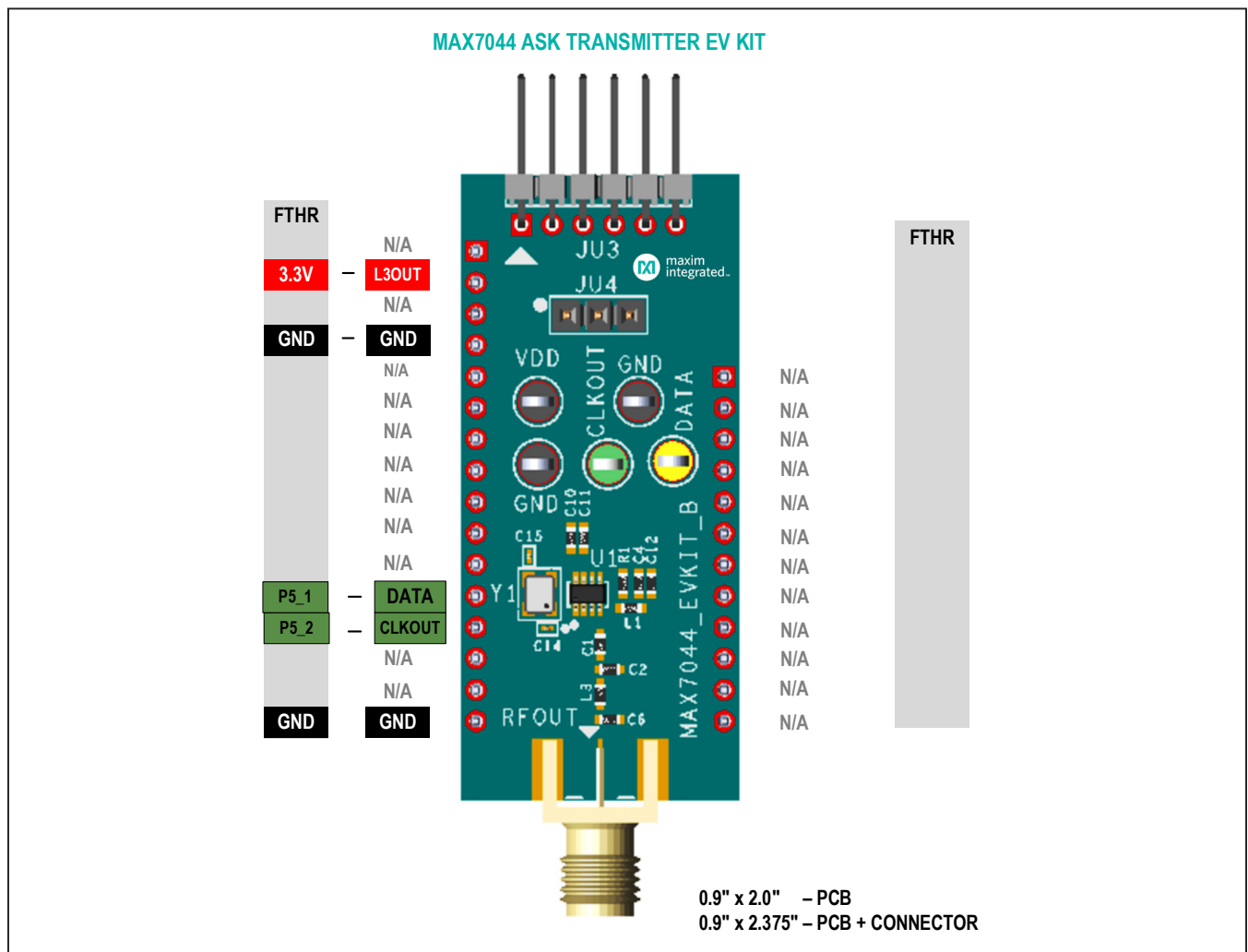

Figure 12. MAX7044 EV kit Interface

PMOD Interface

The EV kit provides a PMOD-compatible header footprint to interface with the transmitter. The JU3 connector can be populated with a 6-pin, 100mil, right-angle header allowing direct connections to the CSB, DATAIN, CLKOUT, SCLK/SDA, ground, and VDD lines. Populating this header would allow control from the MAX32600MBED kit and the MAXREFDES72# Arduino Uno R3 to the PMOD shield adaptor. When using the PMOD interface to supply the

EV kit with power, make sure to connect the JU4 jumper between pins 2-3. See [Appendix II](#) for detailed information on evaluation kit hardware modifications.

Detailed Description of Software

The MAX7044 EV kit Controller GUI software is designed to control the MAX32630FTHR board, as shown in [Figure 3](#). The software utilizes USB controls to program the FTHR board. The FTHR board is capable of providing power and input data to the EV kit.

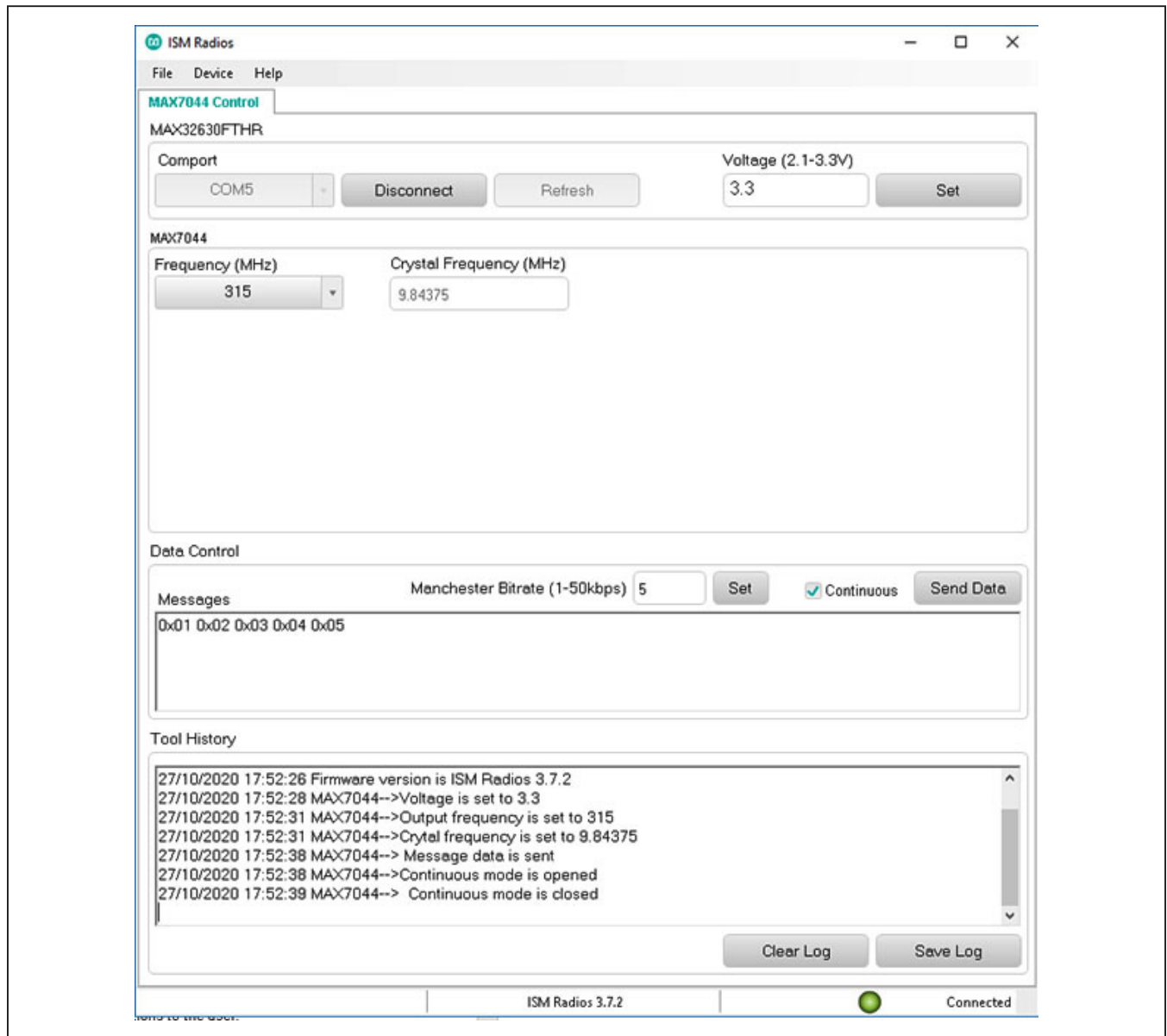

Figure 13. MAX7044 EV kit GUI Configuration

Comport

The Comport section provides a drop-down selection of serial communication ports available for connection to a EV kit through an FTTH board. When the GUI is run after connecting the EV kit hardware, the drop-down box should default to the proper COM port. If the hardware is connected to the computer after the GUI is started, click the **Refresh** button to scan for compatible ports. Once the appropriate COM port is selected in the drop-down box, click the **Connect** button. (See [Figure 6.](#))

After properly connecting to the COM port with the FTTH board, the GUI will display the revision of the FTTH board firmware detected, display a **Green LED**, and display **Connected** in the status bar along the bottom of the GUI window. (See [Figure 7.](#))

Voltage (2.1V to 3.3V)

The Voltage section provides a user-adjustable power supply from the FTTH board MAX14690N power management IC (PMIC) to the EV kit and can be used as the primary VDD supply. The PMIC, L3OUT can be set to voltages between 2.1V to 3.3V and it applies to the level of the logic interface lines as well as the device supply. (See [Figure 8.](#))

To program the supply voltage, enter a valid level in the **Voltage** text box and click on the **Set** button. The default value of the L3OUT voltage is 3.3V.

When using the FTTH board interface to supply the EV kit with power, make sure to connect the JU4 jumper between pins 1-2.

Data Control Section

This portion of the GUI software provides a flexible tool for the user to generate data from a single-pin interface. The GUI provides simple Manchester-encoded data to be sent directly to the DATAIN pin of a connected device.

Manchester Bitrate

This is the data rate in kbps for Manchester-encoded data. Enter a value in the text box and click the **Set** button to configure the **Data Control**.

Continuous Transmission

Selecting this check box will configure the **Data Control** interface so the message or data sequence will repeat until the user interrupts the transmission. For example: when a 0xAA message is sent with **Continuous** unchecked, the sequence of 1-0-1-0-1-0-1-0 bits will be transmitted a single time. When the **Continuous** is checked, the **Send Data** process will continuously send a repeating sequence of 1-0-1-0-1-0-1-0-1-0-1-0-1-0-1-0-1-0-1-0-1-0... bits, emulating a square-wave data pattern.

Messages Text Block and Message File

The **Messages** text block contains hexadecimal encoded data string to be transmitted with the FTTH board over the data interface. The data is streamed directly to the DATAIN pin of the MAX7044 EV kit.

Tool History Section

This portion of the GUI contains a **Log File** text block which is used to record activity within the GUI.

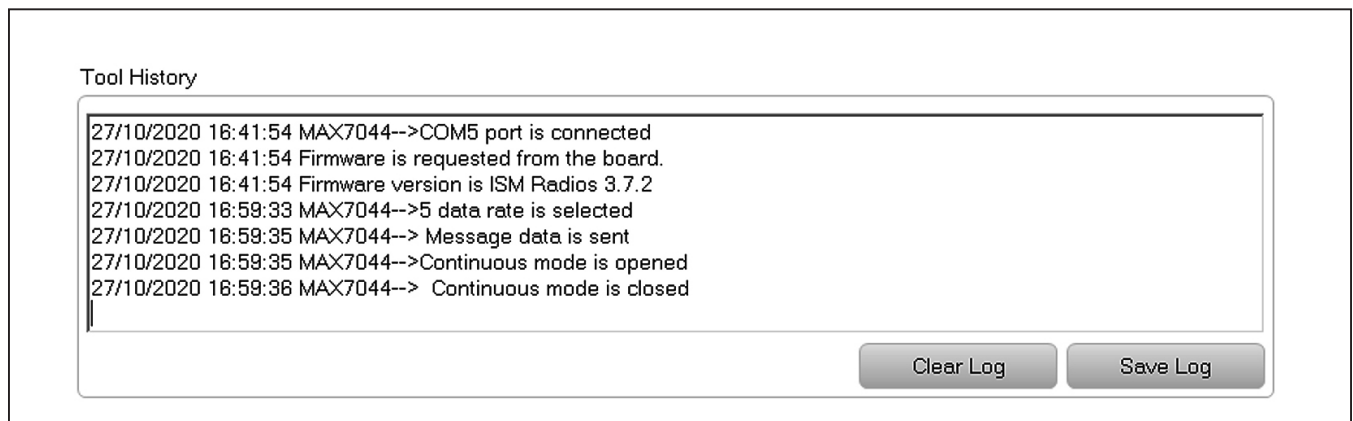

Figure 14. Tool History

Log File

For every **Set**, connection effort, or register programming action, the GUI activity is logged in this text block. The user can add notes and make edits to the content of the **Log File** text block.

Clicking on the **Clear Log** will delete the contents in the text block.

Clicking the **Save Log** button will open a **Save As** explorer window and the user will be prompted to save a .txt file.

Miscellaneous Software Information

The tool bar along the top of the GUI software provides a couple of options to the user.

File and Help Menu

Selecting **File > Exit** from the tool bar will close the GUI program. This has the same effect as clicking the **X** button in the upper-right corner of the GUI software.

Selecting **Help > About** from the tool bar will display the splash screen. This window shows the name of the software, the revision number, a copyright notice, a link to the Maxim website, a link to the support website, and a checkbox to enable or disable the splash screen during startup. Click the **OK** button to close the **About** window.

Component List

PART	QTY	DESCRIPTION
C1	1	Capacitor; smt (0603); ceramic chip; 12pf; 50V; tol = 2%; model = accu-p; tg = -55°C to +125°C; tc = c0g
C1 (433MHz)	1	Capacitor; smt (0603); ceramic chip; 15pf; 50V; tol = 5%; model = ; tg = -55°C to +125°C; tc = c0g
C2	1	Capacitor; smt (0603); ceramic chip; 18pf; 50V; tol = 5%; model = ; tg = -55°C to +125°C; tc = c0g
C2 (433MHz)	1	Capacitor; smt (0603); ceramic chip; 12pf; 50V; tol = 2%; model = accu-p; tg = -55°C to +125°C; tc = c0g
C4, C10	2	Capacitor; smt (0603); ceramic chip; 0.01uf; 100V; tol = 10%; Model = X7R; tg = -55°C to +125°C; tc = USE 20-00u01-M8
C6	1	Capacitor; smt (0603); ceramic chip; 15pf; 50V; tol = 5%; model = ; tg = -55°C to +125°C; tc = c0g
C6 (433MHz)	1	Capacitor; smt (0603); ceramic chip; 12pf; 50V; tol = 2%; model = accu-p; tg = -55°C to +125°C; tc = c0g
C11, C12	2	Capacitor; smt (0603); ceramic chip; 220pf; 50V; tol = 5%; tg = -55°C to +125°C; tc = c0g

PART	QTY	DESCRIPTION
CLKOUT	1	Test point; pin dia = 0.125in; total length = 0.445in; board hole = 0.063in; green; phosphor bronze wire silver plate finish; recommended for board thickness = 0.062in; not for cold test
DATA	1	Test point; pin dia = 0.125in; total length = 0.445in; board hole = 0.063in; yellow; phosphor bronze wire silver plate finish; recommended for board thickness = 0.062in; not for cold test
GND, GND1, VDD	3	Test point; pin dia = 0.125in; total length = 0.445in; board hole = 0.063in; black; phosphor bronze wire silver plate finish; recommended for board thickness = 0.062in; not for cold test
H1	1	Connector; male; through hole; prpc series; straight; 16pins
H2	1	Connector; male; through hole; prpc series; straight; 12pins
J1	1	Connector; female; through hole; lfb series; 2.54mm contact center; straight; 16pins
J2	1	Connector; female; through hole; header female; straight; 12pins

Component List (continued)

PART	QTY	DESCRIPTION
JU4	1	Connector; male; through hole; breakaway; straight; 3pins
L1	1	Inductor; smt (0603); ceramic chip; 27nh; tol = ±5%; 0.6a; -40°C to +125°C
L3	1	Inductor; 0603; 18nh; 5%; 700ma; -40°C to +125°C
L3 (433MHz)	1	Inductor; smt (0603); ceramic chip; 16nh; tol = ±5%; 0.7a; -40°C to +125°C
R1, R3, R8	3	Resistor; 0603; 0Ω; 0%; jumper; 0.1W; thick film
RFOUT	1	Connector; end launch jack receptacle; boardmount; straight through; 2pins;
SU1	1	Test point; jumper; str; total length = 0.24in; black; insulation = pbt; phosphor bronze contact = gold plated
U1	1	Ic; xmtr; 300mhz to 450mhz high-efficiency; crystal-based +13dbm ask transmitter; sot23-8

PART	QTY	DESCRIPTION
Y1	1	Crystal; smt; 6.27pf; 9.84375MHz; ±80ppm; note: special order only
Y1 (433MHz)	1	Crystal; smt; 6.27pf; 13.56MHz; ±80ppm ;
MOD1	DNI	Module; board assembly; through hole; MAX32630FTHR# laminated plastic with copper clad
PCB	1	PCB: MAX7044
DO NOT PURCHASE(DNP)		
C14, C15	2	Cap; smt (01005); 5pf; ±0.25pf; 50V; c0g; ceramic chip; note: purchase direct from the manufacturer
JU3	1	Connector; male; through hole; 0.025in sq post header; right angle; 6pins
R2, R4, R5, R9	4	Resistor; 0603; 0Ω; 0%; jumper; 0.1w; thick film
Y1	0	Crystal; smt 3.2 x 2.5; 10pf; 9.84375MHz; ±10ppm; Note: special order only

Component Suppliers

SUPPLIER	PHONE	WEBSITE
YXC Crystal	—	www.yxcxtal.com
NDK Crystal	—	www.ndk.com
Keystone	800-221-5510	www.keyelco.com
Murata Electronics North America, Inc.	770-436-1300	www.murata.com
Coilcraft	847-639-6400	www.coilcraft.com
Sullins	760-744-0125	www.sullinscorp.com
Vishay Dale	800-433-5700	www.vishay.com

Note: Indicate that you are using the MAX7044 when contacting these component suppliers.

Ordering Information

PART	TYPE
MAX7044EVKIT-315	MAX7044 EV kit tuned to 315MHz
MAX7044EVKIT-433	MAX7044 EV kit tuned to 433MHz

MAX7044 EV Kit Bill of Materials

ITEM	REF_DES	DNI/DNP	QTY	MFG PART #	MANUFACTURER	VALUE	DESCRIPTION
1	C1	—	1	06035J120GBT; GRM1885C1H120GA01	AVX; MURATA	12PF	CAP; SMT (0603); 12PF; 2%; 50V; +/- 0 TO 30PPM/DEGC; CERAMIC
2	C2	—	1	C0603C0G500-180JNE; C1608C0G1H180J080AA; GRM1885C1H180J	VENKEL LTD.; TDK;MURATA	18PF	CAP; SMT (0603); 18PF; 5%; 50V; C0G; CERAMIC
3	C4, C10	—	2	CGA3E2X7R2A103K; C0603C103K1RA; GRM188R72A103KA01; C1608X7R2A103K080AA	TDK;KEMET; MURATA;TDK	0.01UF	CAP; SMT (0603); 0.01UF; 10%; 100V; X7R; CERAMIC;
4	C6	—	1	GRM39C0G150J50V; GRM1885C1H150JA01	MURATA; MURATA	15PF	CAP; SMT (0603); 15PF; 5%; 50V; C0G; CERAMIC
5	C11, C12	—	2	GRM1885C1H221JA01	MURATA	220PF	CAP; SMT (0603); 220PF; 5%; 50V; C0G; CERAMIC
6	CLKOUT	—	1	5126	KEystone	N/A	TEST POINT; PIN DIA=0.125IN; TOTAL LENGTH=0.445IN; BOARD HOLE=0.063IN; GREEN; PHOSPHOR BRONZE WIRE SILVER PLATE FINISH;
7	DATA	—	1	5014	KEystone	N/A	TEST POINT; PIN DIA=0.125IN; TOTAL LENGTH=0.445IN; BOARD HOLE=0.063IN; YELLOW; PHOSPHOR BRONZE WIRE SILVER PLATE FINISH;
8	GND, GND1, VDD	—	3	5011	KEystone	N/A	TEST POINT; PIN DIA=0.125IN; TOTAL LENGTH=0.445IN; BOARD HOLE=0.063IN; BLACK; PHOSPHOR BRONZE WIRE SILVER PLATE FINISH;
9	H1	—	1	PRPC016SFAN-RC	SULLINS ELECTRONICS CORP	PRPC016SFAN-RC	CONNECTOR; MALE; THROUGH HOLE; PRPC SERIES; STRAIGHT; 16PINS
10	H2	—	1	PRPC012SFAN-RC	SULLINS ELECTRONICS CORP	PRPC012SFAN-RC	CONNECTOR; MALE; THROUGH HOLE; PRPC SERIES; STRAIGHT; 12PINS
11	J1	—	1	PPPC161LFBN-RC	SULLINS ELECTRONICS CORP	PPPC161LFBN-RC	CONNECTOR; FEMALE; THROUGH HOLE; LFB SERIES; 2.54MM CONTACT CENTER; STRAIGHT; 16PINS
12	J2	—	1	PPPC121LFBN-RC	SULLINS ELECTRONICS CORP	PPPC121LFBN-RC	CONNECTOR; FEMALE; THROUGH HOLE; HEADER FEMALE; STRAIGHT; 12PINS
13	JU4	—	1	PEC03SAAN	SULLINS	PEC03SAAN	CONNECTOR; MALE; THROUGH HOLE; BREAKAWAY; STRAIGHT; 3PINS
14	L1	—	1	0603CS-27NXJL	COILCRAFT	27NH	INDUCTOR; SMT (0603); CERAMIC CHIP; 27NH; TOL=+/-5%; 0.6A; -40 DEGC TO +125 DEGC
15	L3	—	1	0603CS-18NXJL	COIL CRAFT	18NH	INDUCTOR; 0603; 18nH; 5%; 700mA; -40degC TO +125degC
16	R1, R3, R8	—	3	CRCW06030000Z0	VISHAY DALE	0	RES; SMT (0603); 0; JUMPER; JUMPER; 0.1000W
17	RFOUT	—	1	142-0701-851	JOHNSON COMPONENTS	142-0701-851	CONNECTOR; END LAUNCH JACK RECEPTACLE; BOARDMOUNT; STRAIGHT THROUGH; 2PINS;
18	SU1	—	1	S1100-B;SX1100-B; STC02SYAN	KYCON;KYCON; SULLINS ELECTRONICS CORP.	SX1100-B	TEST POINT; JUMPER; STR; TOTAL LENGTH=0.24IN; BLACK; INSULATION=PBT;PHOSPHOR BRONZE CONTACT=GOLD PLATED
19	U1	—	1	MAX7044AKA+	MAXIM	MAX7044AKA+	IC; XMTR; 300MHZ TO 450MHZ HIGH-EFFICIENCY; CRYSTAL-BASED +13DBM ASK TRANSMITTER; SOT23-8
20	Y1	—	1	NX3225GA-9.84375MHZ -EXS00A-CG08008	NIHON DEMP KOGYO CO	9.84375MHZ	CRYSTAL; SMT; 6.27PF; 9.84375MHZ; +/-80PPM ;
21	PCB	—	1	MAX7044	MAXIM	PCB	PCB;MAX7044
22	MOD1	DNI	1	89-32630#KFT	MAXIM	89-32630#KFT	MODULE; BOARD ASSEMBLY; THROUGH HOLE; MAX32630FTHR# LAMINATED PLASTIC WITH COPPER CLAD
23	C14, C15	DNP	0	GRM0225C1H5R0CA03	MURATA	5PF	CAP; SMT (01005); 5PF; +/-0.25PF; 50V; C0G; CERAMIC;
24	JU3	DNP	0	TSW-106-25-T-S-RA	SAMTEC	TSW-106-25-T-S-RA	CONNECTOR; MALE; THROUGH HOLE; 0.025IN SQ POST HEADER; RIGHT ANGLE; 6PINS
25	R2, R4, R5, R9	DNP	0	CRCW06030000Z0	VISHAY DALE	0	RES; SMT (0603); 0; JUMPER; JUMPER; 0.1000W
26	Y1	DNP	0	X3225984375MSB4SI	YXC	9.84375MHZ	CRYSTAL; SMT 3.2X2.5; 10PF; 9.84375MHZ; +/-10PPM;
TOTAL			28				

MAX7044 EV Kit Schematic Diagram

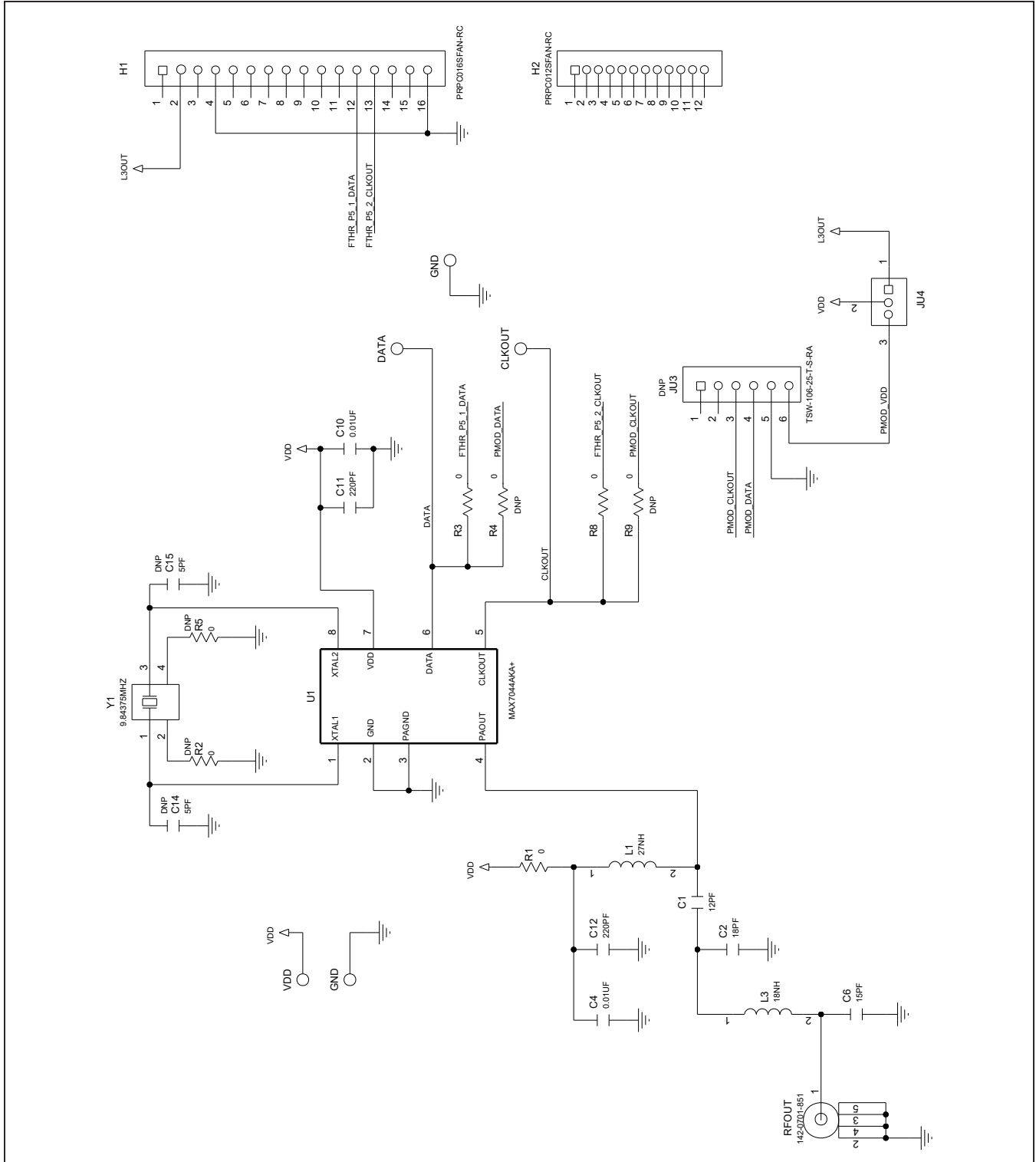

MAX7044 EV Kit PCB Layout Diagrams

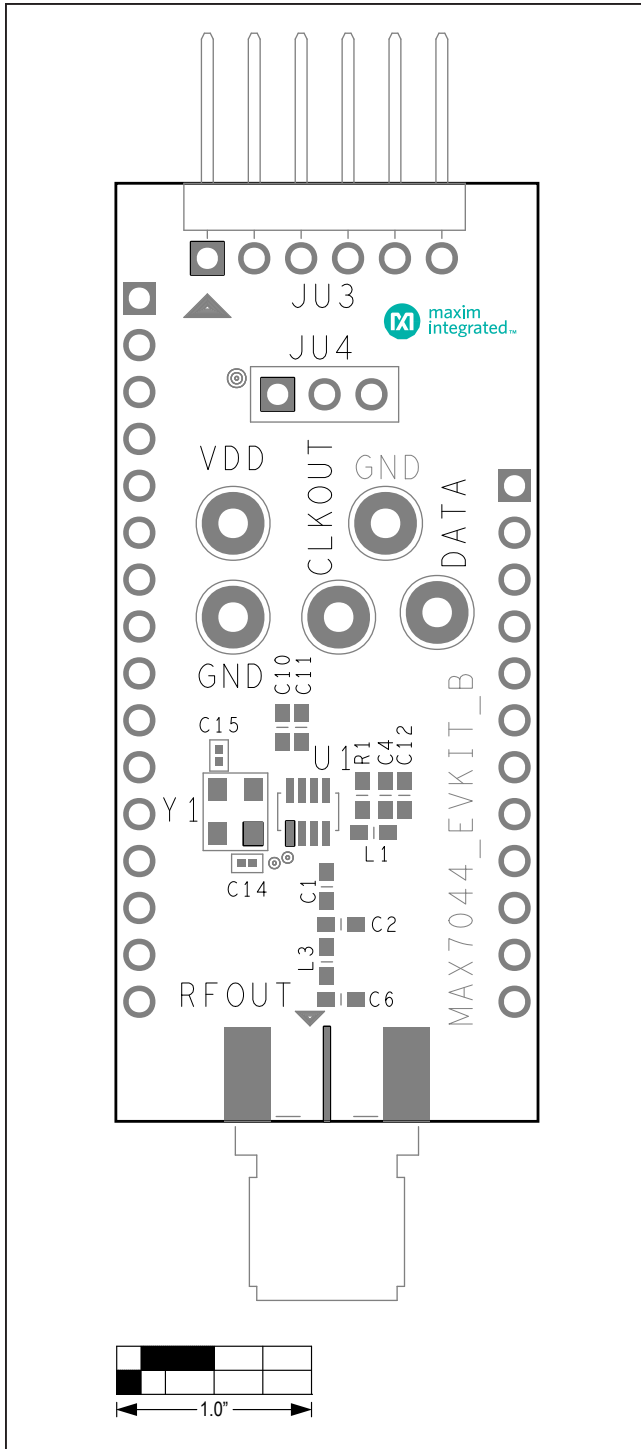

MAX7044 EV Kit Component Placement Guide—Top Silkscreen

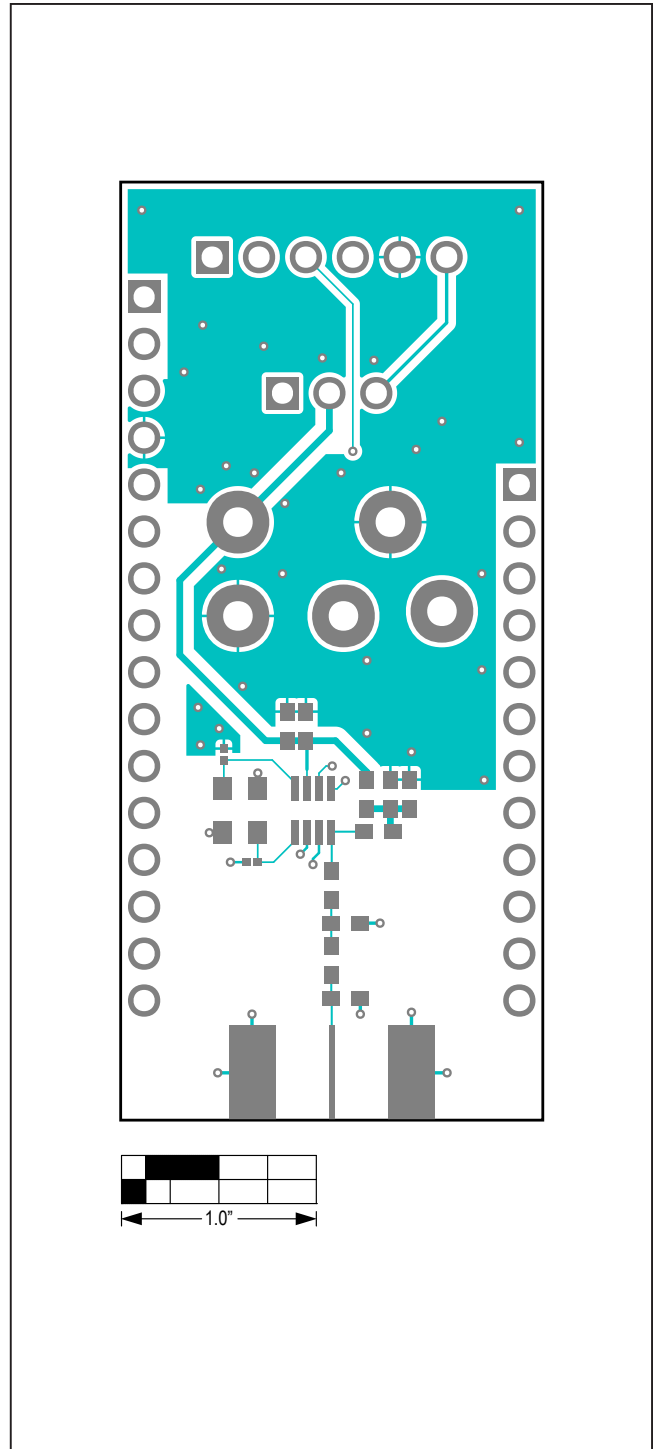

MAX7044 EV Kit PCB Layout—Top Layer

MAX7044 EV Kit PCB Layout Diagrams (continued)

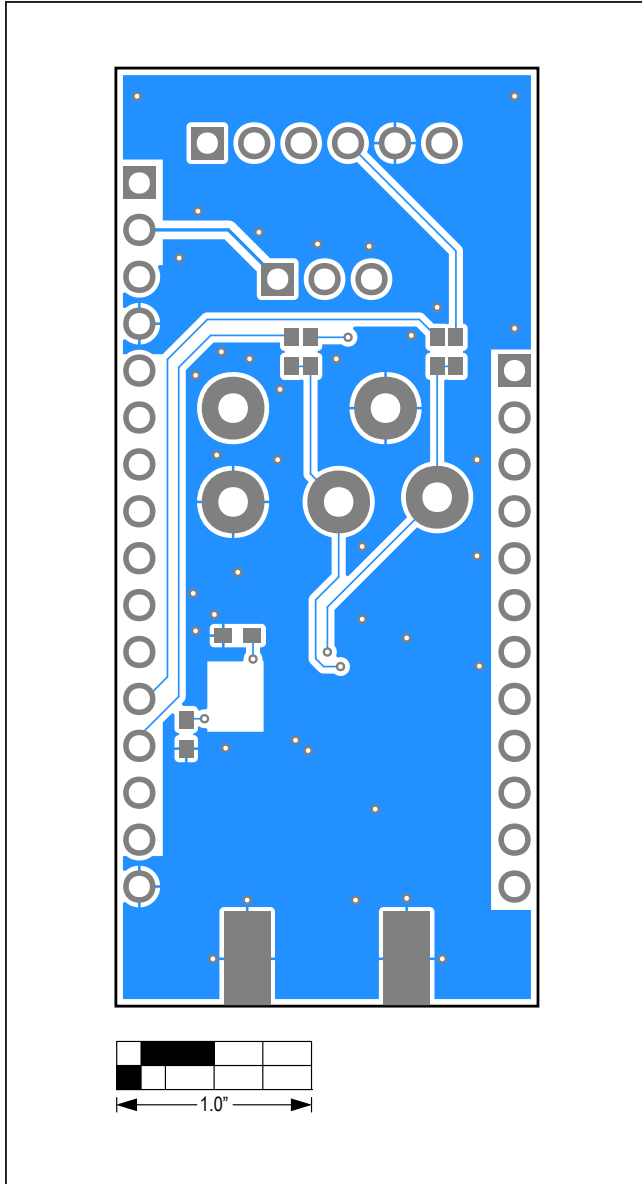

MAX7044 EV Kit PCB Layout—Bottom Layer

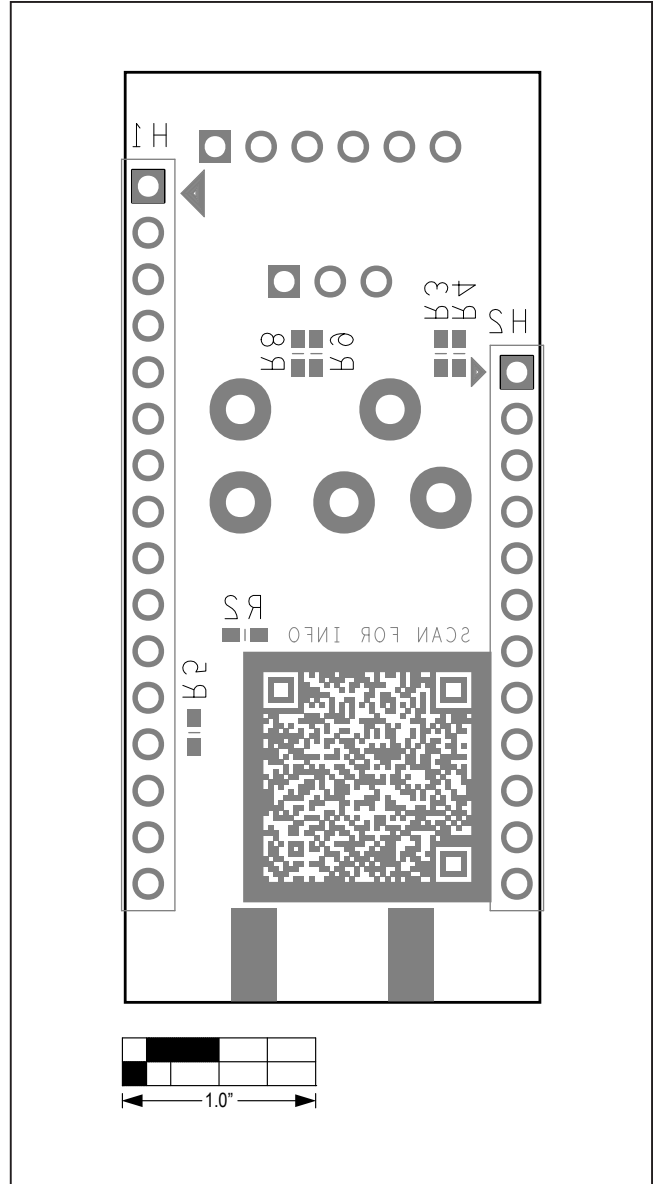

MAX7044 EV Kit PCB Layout—Bottom Silkscreen

Appendix I – Detailed Software, Firmware, and Driver Installation Procedures

This software and firmware are available from the [Maxim Website](#).

- 1) Log in to your **My Maxim** account on the website.

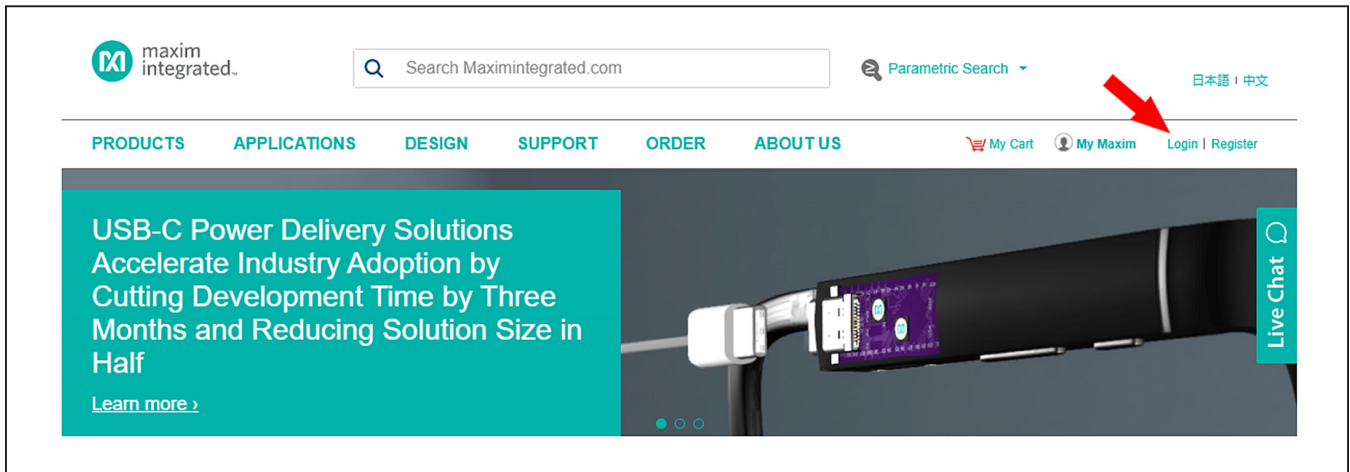

- 2) Click on the magnifying glass and search for the **MAX7044**.

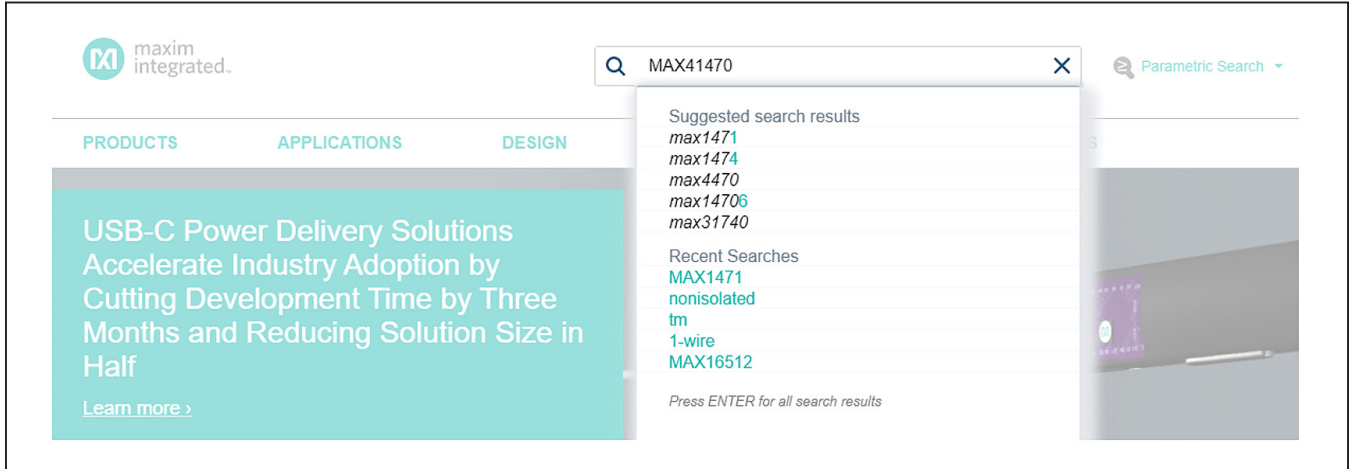

- 3) Click on the **Design Resources** tab on the appropriate product web page.

4) Click on the appropriate software link.

Maxim > Products > Communications > Wireless and RF > MAX1471

MAX1471

315MHz/434MHz Low-Power, 3V/5V ASK/FSK Superheterodyne Receiver

300MHz to 450MHz Superheterodyne ASK/FSK Receiver with Integrated Image Rejection Operates from 3V or 5V Supply

[Download Data Sheet](#) [Subscribe](#) [Active in Production](#)

Please check latest availability status for a specific part variant.

- OVERVIEW
- PARAMETRIC SEARCH
- DESIGN RESOURCES**
- QUALITY AND ENVIRONMENTAL
- ORDER

MAX1471EVKIT-315: Evaluation Kit for the MAX1471
MAX1471EVKIT-433: Evaluation Kit for the MAX1471

Technical Documents

- Tutorial 5436 [Getting Started with a Radio Design](#)
- Tutorial 5428 [Squelch in ISM-RF Receivers](#)
- Tutorial 5426 [Baseband Calculations for ISM-RF Receivers](#)
- Tutorial 5422 [Crystal Calculations for ISM-RF Products](#)
- Tutorial 5417 [How to Optimize an ISM Radio Frequency \(RF\) System](#)

Tools & Models

- [MAX1471 Gerber File](#)

Software

- [MAX1471 Receiver EV Kit Software](#)
- [ISM Radios GUI](#)

Related Resources

- RELATED PRODUCTS
- RELATED PACKAGING
- TOOLS & MODELS
- TECHNICAL DOCS
- REFERENCE DESIGNS

Live Chat

5) Click the file link on the software landing page to download the MAX7044 EV kit package.

By using this website, I accept the use of cookies. [Learn More](#)

maxim integrated. Search Maximintegrated.com Parametric Search 日本語 | 中文

PRODUCTS APPLICATIONS DESIGN SUPPORT ORDER ABOUT US My Cart My Maxim Login | Register

Maxim > Design > EV Kit Software

EV KIT SOFTWARE

ISM Radios GUI

Software Version: 3.7.2
File Name: ISMRadiosGUISetup_v3.7.2_2020_June_29_withUpdatedFW.msi
Description: GUI supporting the ISM products
Operating Systems Supported: Windows 10
Required Hardware:
Related Product Folder(s): MAX1471
Notes:

Live Chat

6) Review the **Maxim Software License Agreement (SLA)** and accept the terms by clicking the **Accept** button.

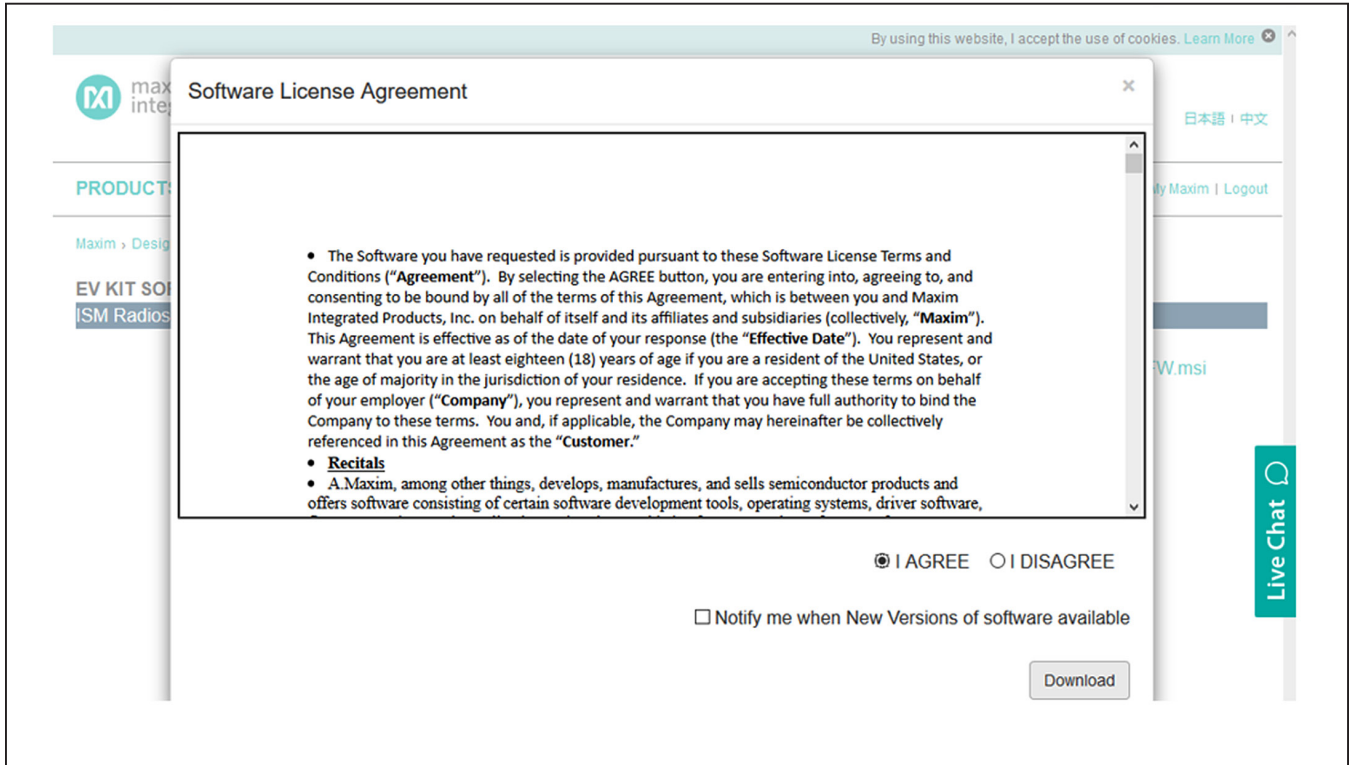

7) Save the **EV kit distribution package** to your desktop or other accessible location for later install.

Install the ISM Radios GUI

This software and firmware are available from the [Maxim Website](#). See the *Download the ISM Radios GUI* section for information on obtaining the latest firmware from Maxim. This process should take less than 10 minutes after downloading the software, firmware, and driver package.

- 1) Double-click the **ISMRadiosGUISetup.msi** setup file and follow the **Setup Wizard** prompts.
 - a. If a **Security Warning** popup window appears, click **Run**.

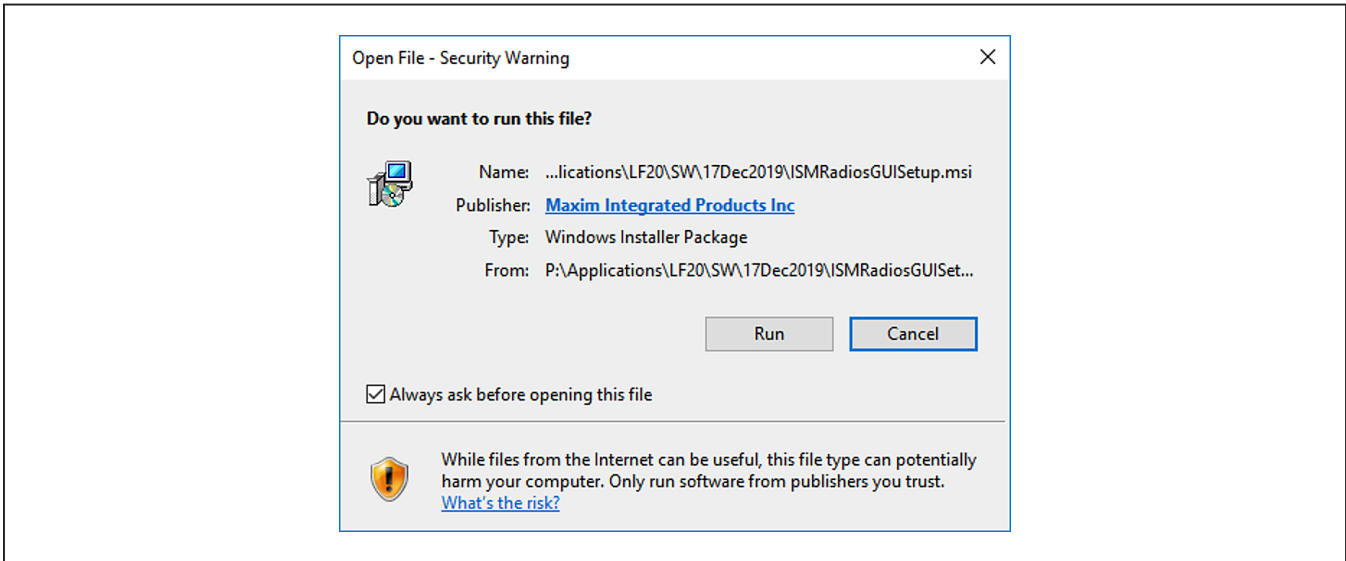

- b. Click **Next**.

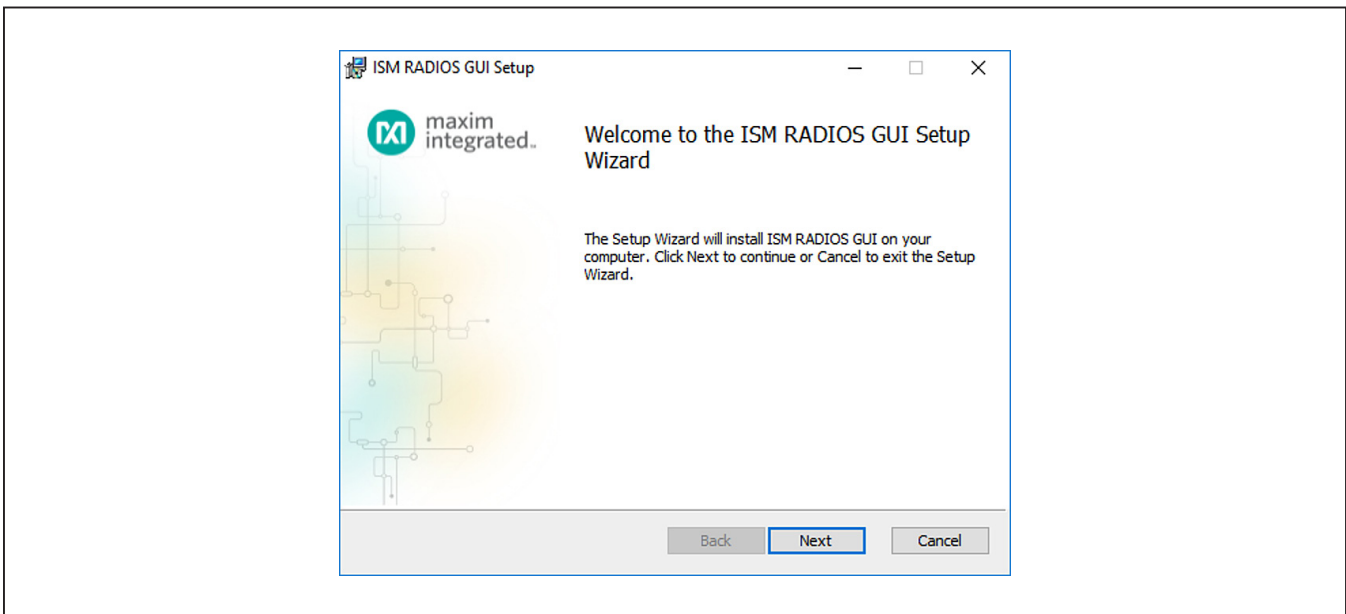

c. Use the default **Destination Folder** and click **Next**.

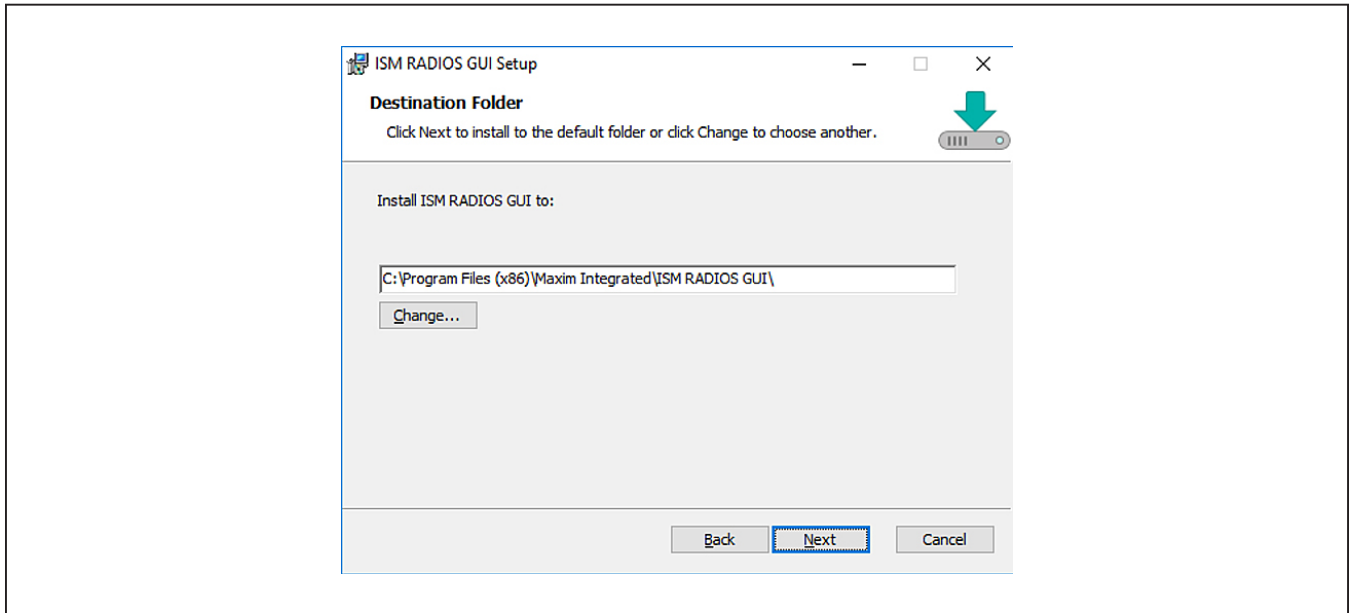

d. Install the software by clicking **Install**.

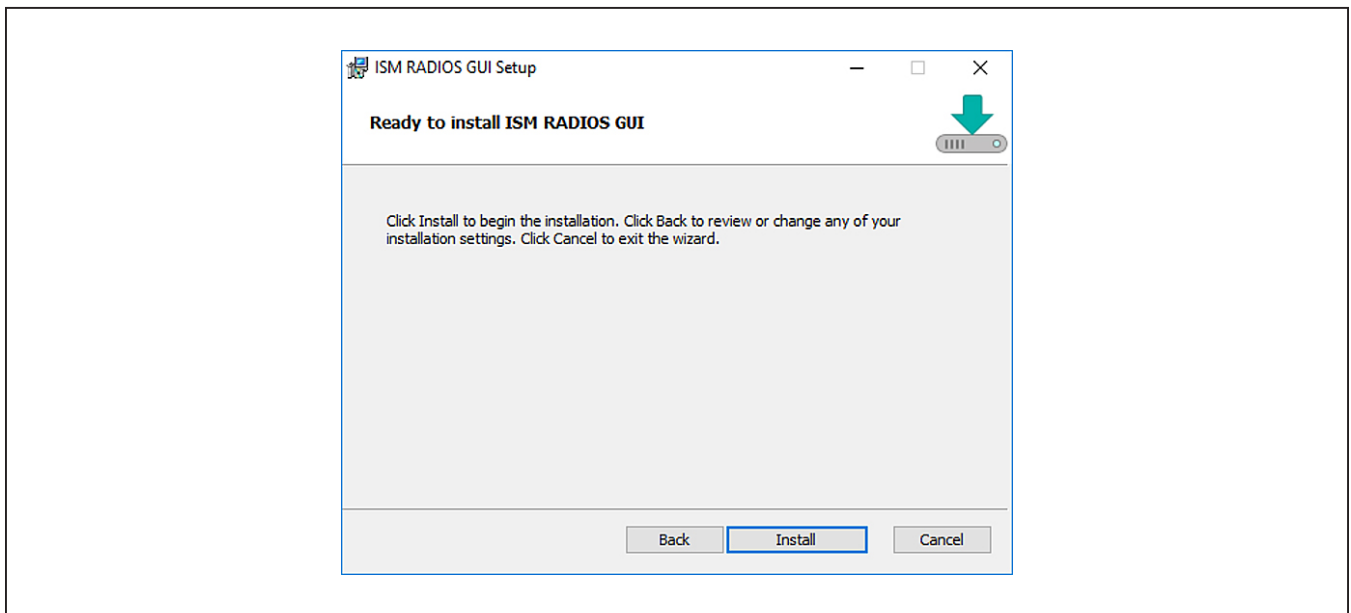

- e. Click **Finish** when the setup process is complete.

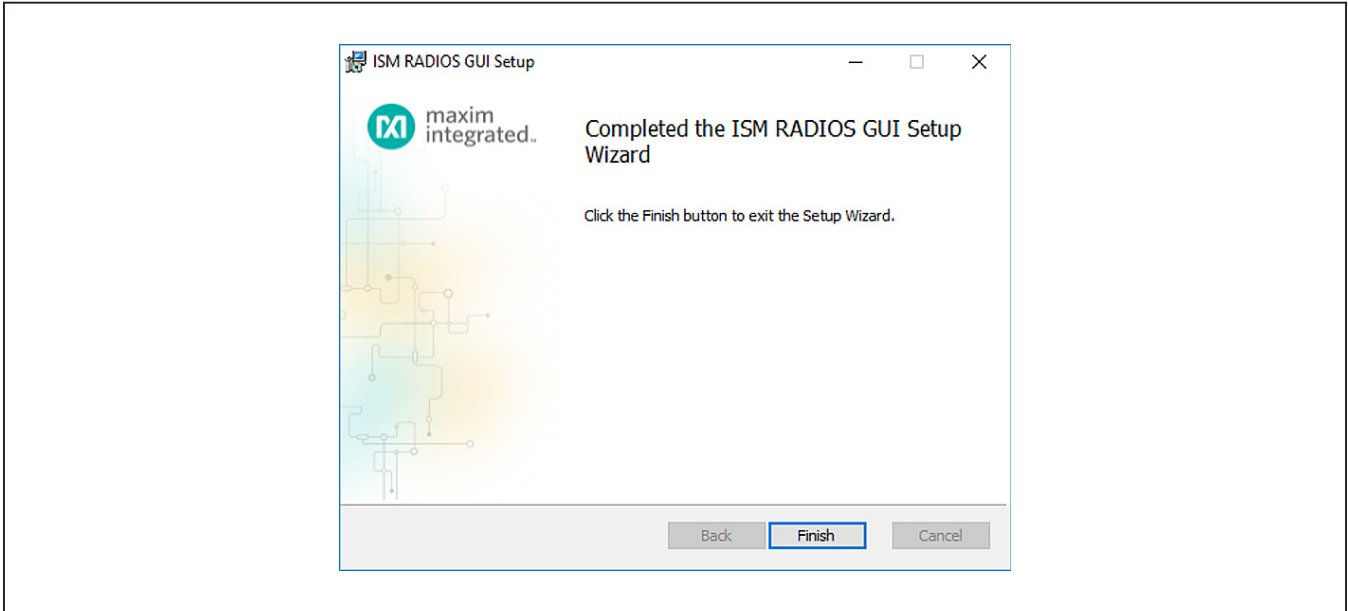

Program the MAX32630FTHR Board with the MAX7044 Firmware

This software and firmware are available from the [Maxim Website](#). See the *Download the ISM Radios GUI Software Package* section for information on obtaining the latest firmware from Maxim.

- 1) Connect the MAX32630FTHR to the MAX32625PICO.
 - a. Use the fine pitch 10-pin ribbon cable to connect the boards from the SWD (J3) header on the MAX32625PICO to J4 on the MAX32630FTHR.

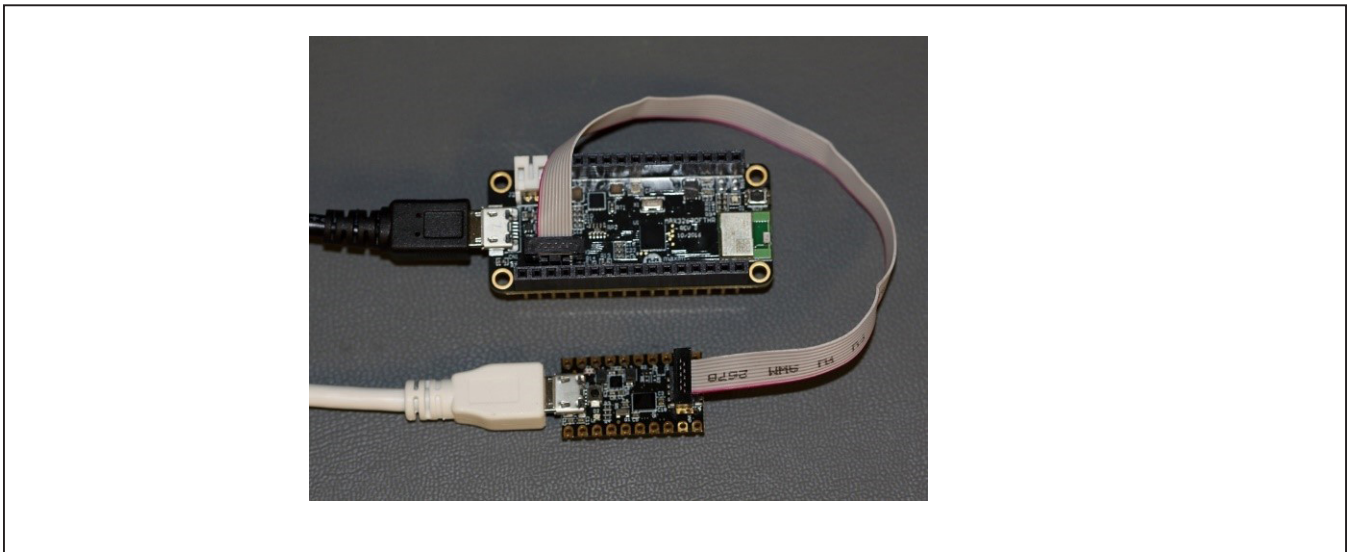

MAX32625PICO DAPLINK

- 2) Connect the **MAX32630FTHR** to a power source.
 - a. Use a **Micro-B USB cable** to connect the **MAX32630FTHR board** to a suitable power source (no USB connectivity is required). [The black USB cable in the photos.] Alternatively, you can power the board from a charged battery as long as you remember to turn it on by pressing the power/reset button next to the battery connector. The board turns on automatically when powered from the USB supply.
 - b. The status LED on the FTHR board should be lit a **steady red**.
- 3) Connect the **MAX32625PICO** to a PC.
 - a. Use a **Micro-B USB cable** to connect the **MAX32625PICO** to a PC through the USB connector. [The white USB cable in the photos.]



- b. The status LED on the DAPLINK board **blinks red** when connecting.
 - c. After a few seconds of activity, the PC recognizes the DAPLINK as a standard USB drive.
- 4) Drag-and-drop or save a the **ISM_Radio_fw.bin** program binary to the **Mbed** or **DAPLINK USB** Drive.

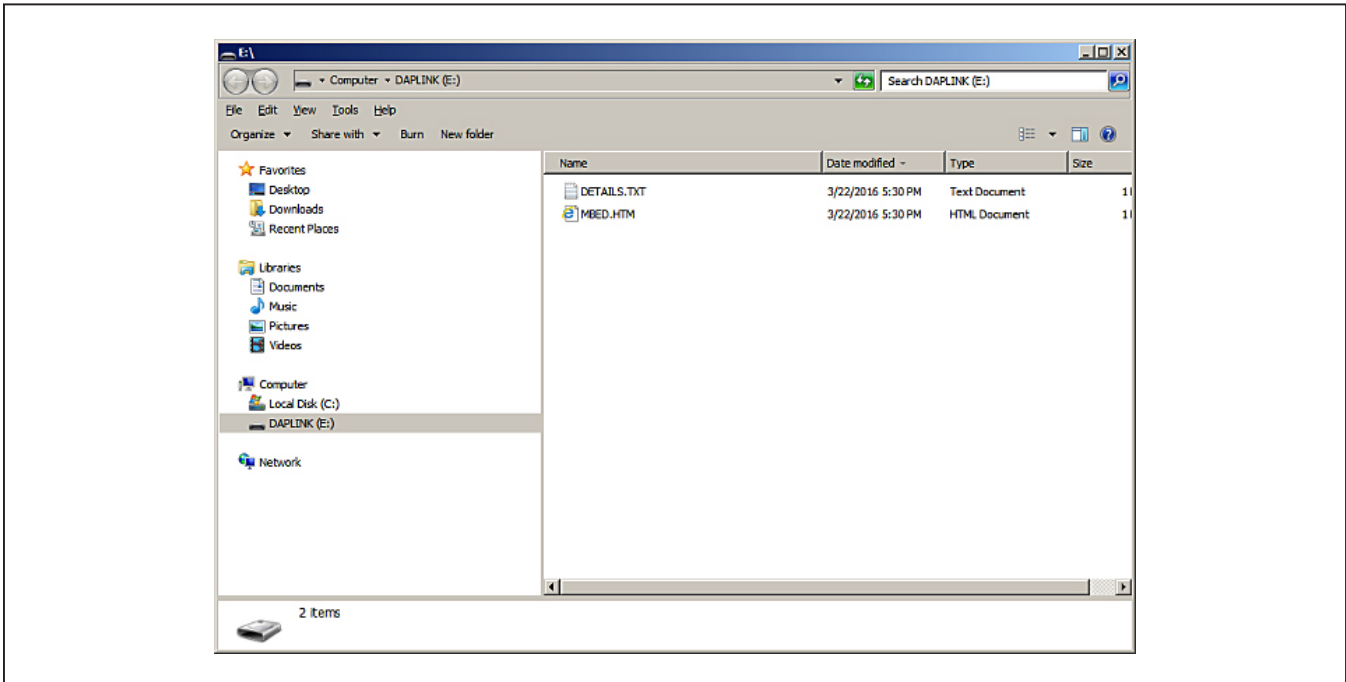

- a. The FTTH board LED will **shut off** and the LED on the MAX32625PICO slowly **flashes red** as the FTTH board is being programmed.
 - b. Once the programming is complete, the MAX32625PICO USB drive disconnects from the PC and reconnect as a USB Drive again.
 - c. If the programming was successful, the contents of the MAX32625PICO USB Drive should include a DETAILS.TXT file. If an **ERROR.TXT** file exists on the drive, check that the FTTH board had power during the programming process and repeat steps 3 and 4.
- 5) To ready the FTTH board for use, **disconnect** the MAX32625PICO board (ribbon cable) and press the **Reset** button on the FTTH board or disconnect the FTTH board from the USB power supply.
- a. When the **Reset** button is pressed, the microcontroller restarts and the newly programmed application begins to run, or you can disconnect and reconnect the USB cable if using a PC for power.

The latest information and these firmware update instructions can be found on the MAX32630FTTH board [Mbed web site](#) or by visiting the [Mbed home page](#) and searching for “MAX32630FTTH.”

If you do not have an Mbed account, choose **Signup** and create your Mbed account. Otherwise, **log in** with your username and password. This will give you access to the website, tools, libraries, and documentation.

You must load the matching HDK image for the platform you are programming in order for drag-and-drop programming to work. For the MAX32630FTTH DAPLINK image:

https://os.mbed.com/media/uploads/switches/max32620_daplink_max32630fthr.bin

Update the MAX32630FTHR Board Driver

The required driver is available from the [Maxim Website](#). See the *Download the ISM Radios GUI Software* section for information on obtaining the latest driver from Maxim.

- 1) Connect the MAX32630FTHR to the PC's USB port.
- 2) In **Device Manager**, right-click **Other devices** → **CDC Device** or **Mbed Composite Device**.

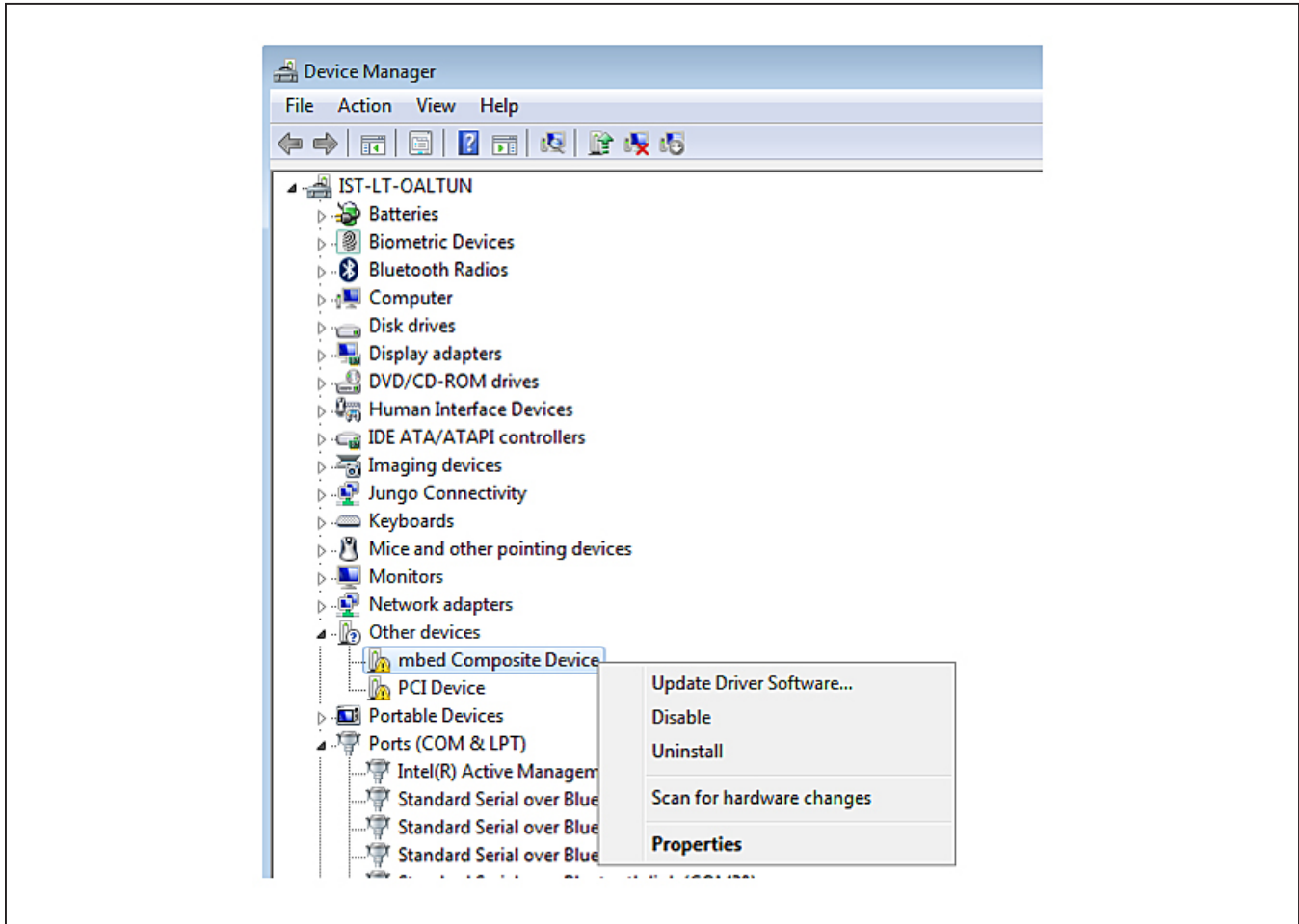

3) Click **Update Driver Software** then select **Browse my computer for driver software**.

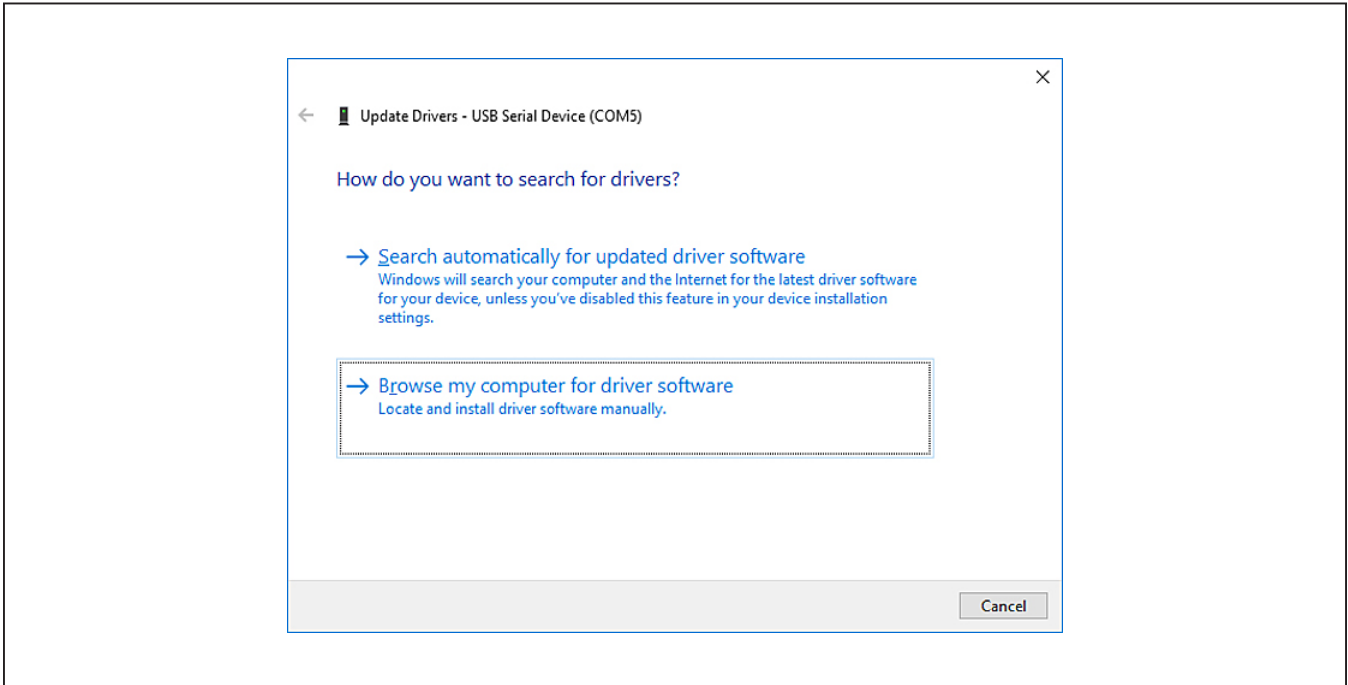

4) Select **Let me pick from a list of available drivers on my computer**.

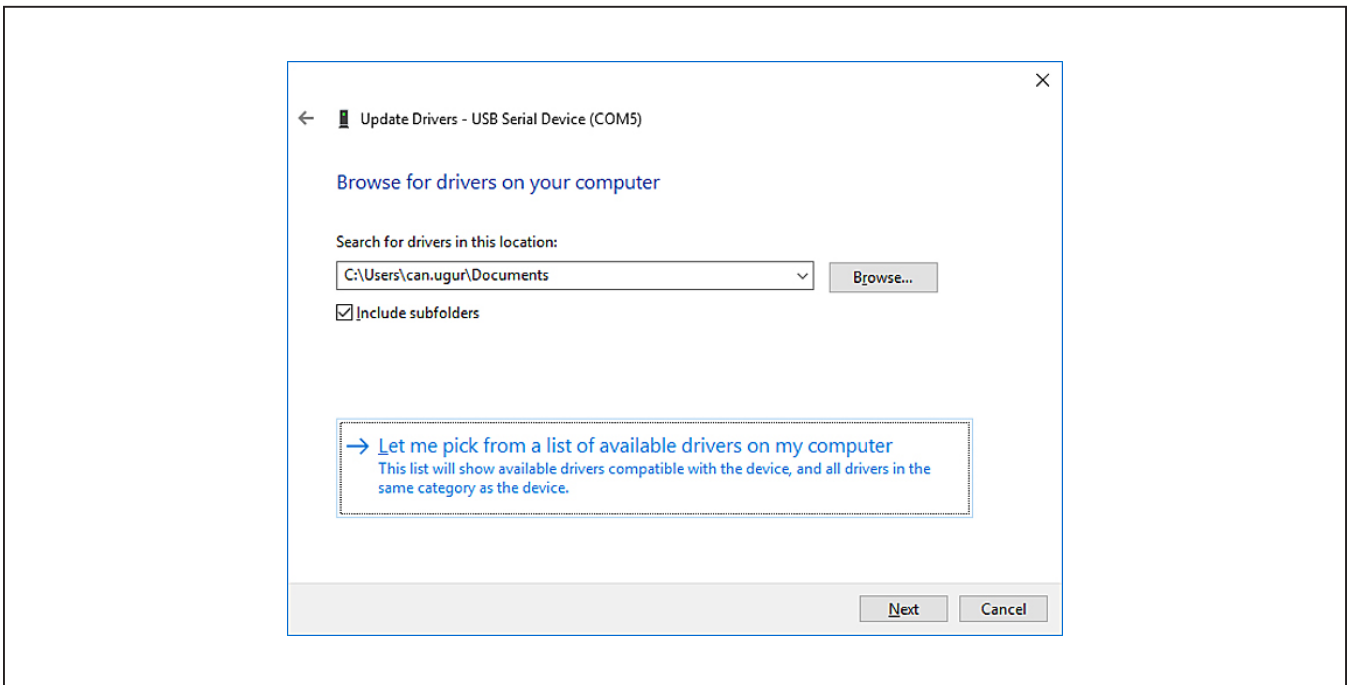

5) On a Windows 10 operating system, click the **Have Disk...** button.

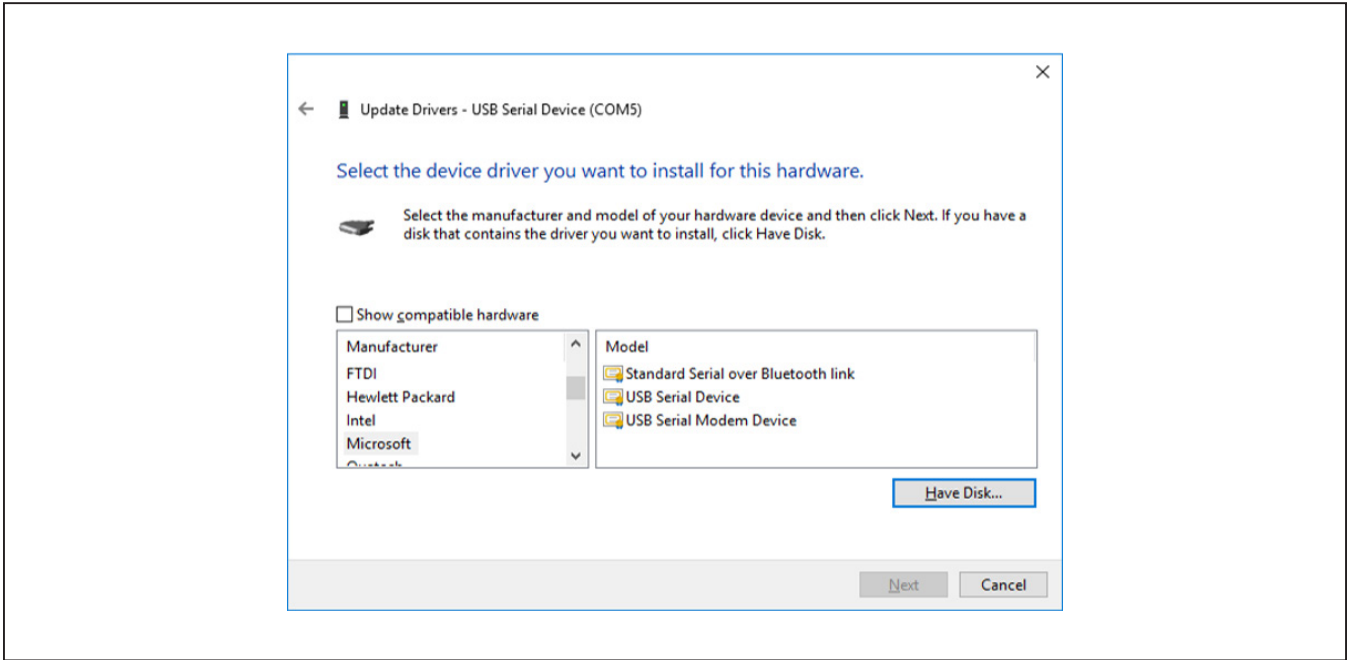

Windows 10: Have Disk... Button

6) Browse the path of driver folder and for Windows 10 click **OK**.

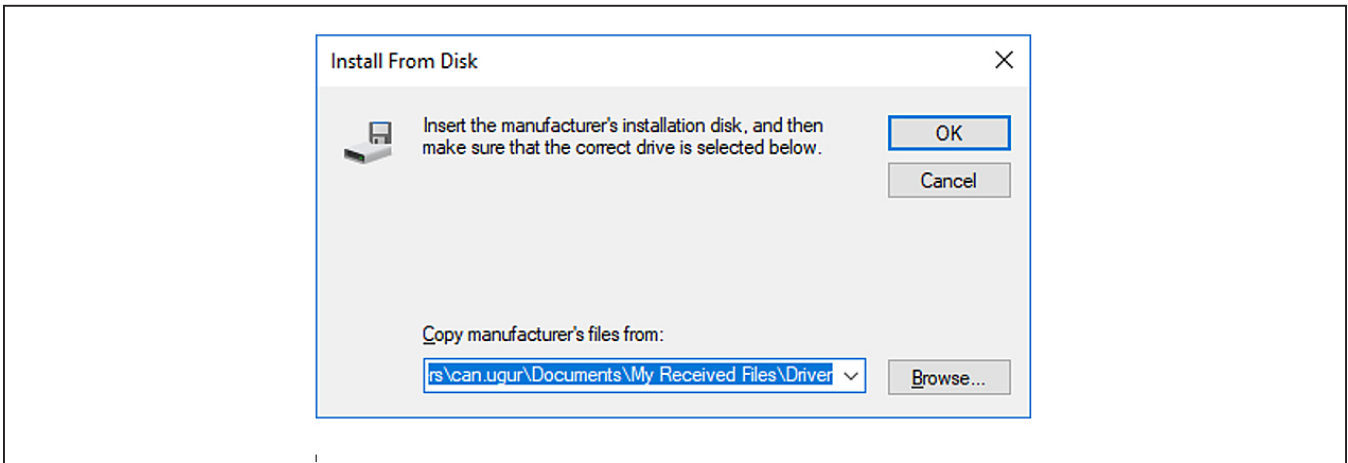

Windows 10: Browse to the Path and Click **OK**.

7) Click **Next**.

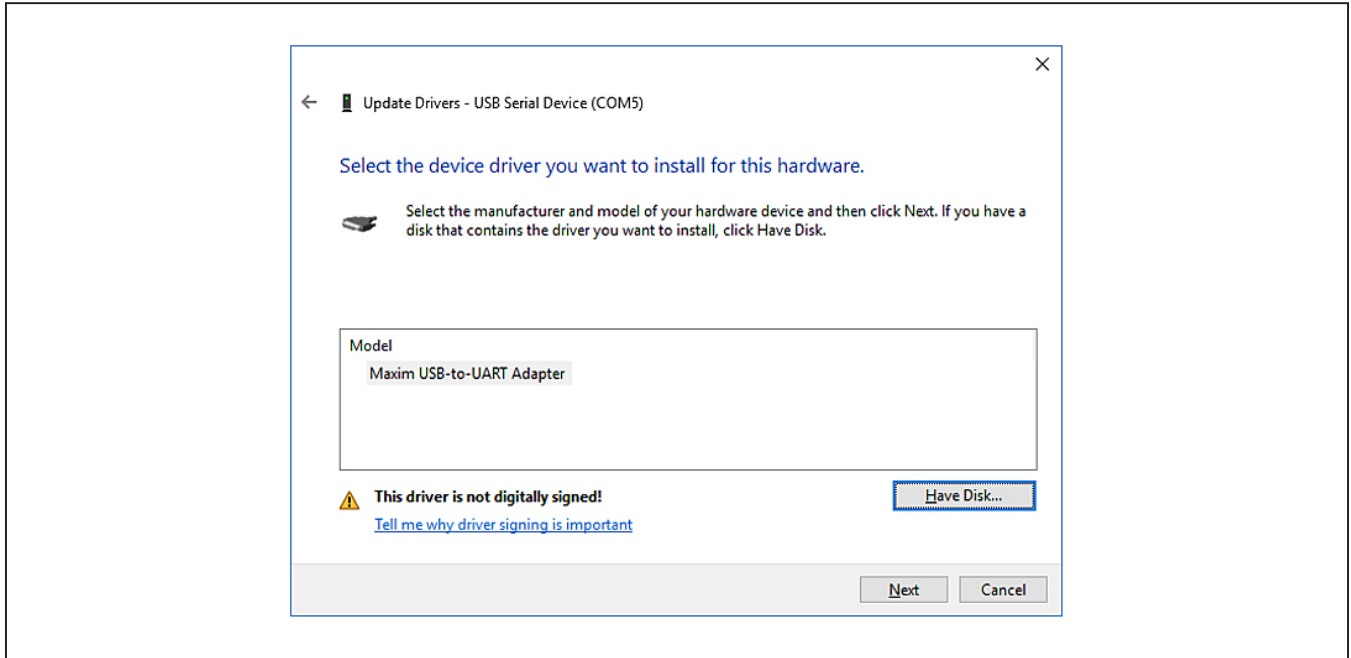

8) Ignore the warnings and click **Install this driver software anyway**.

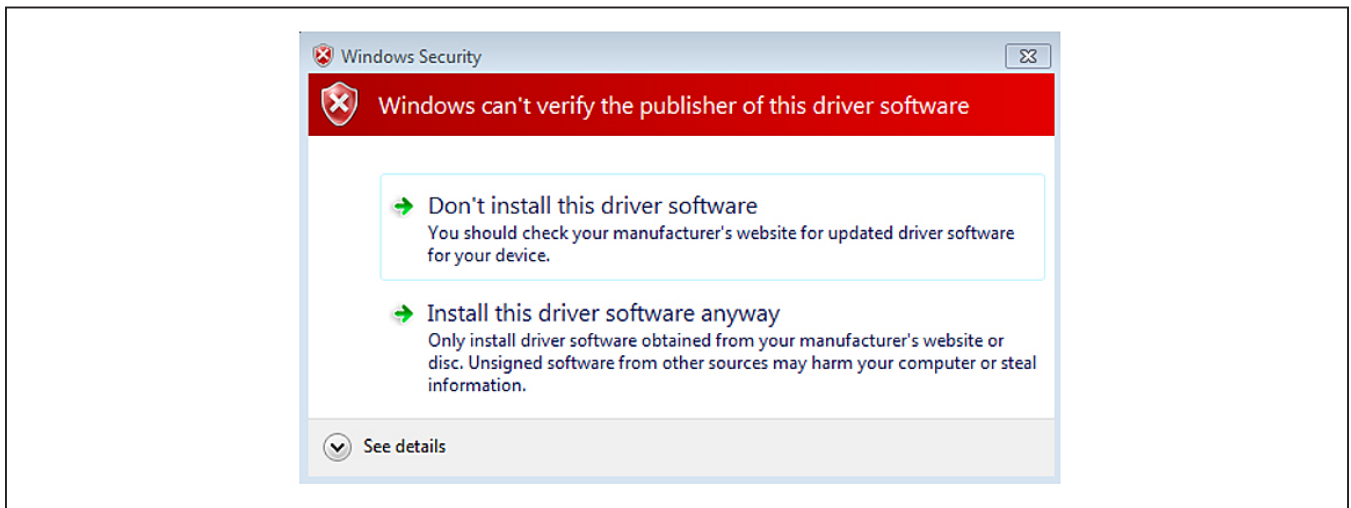

Windows 10: Unverified Publisher Warning

Appendix II – Hardware Modifications

Matching Network

For optimal performance of the transmitter PA, the antenna-matching network should be tuned to the operating frequency of the radio.

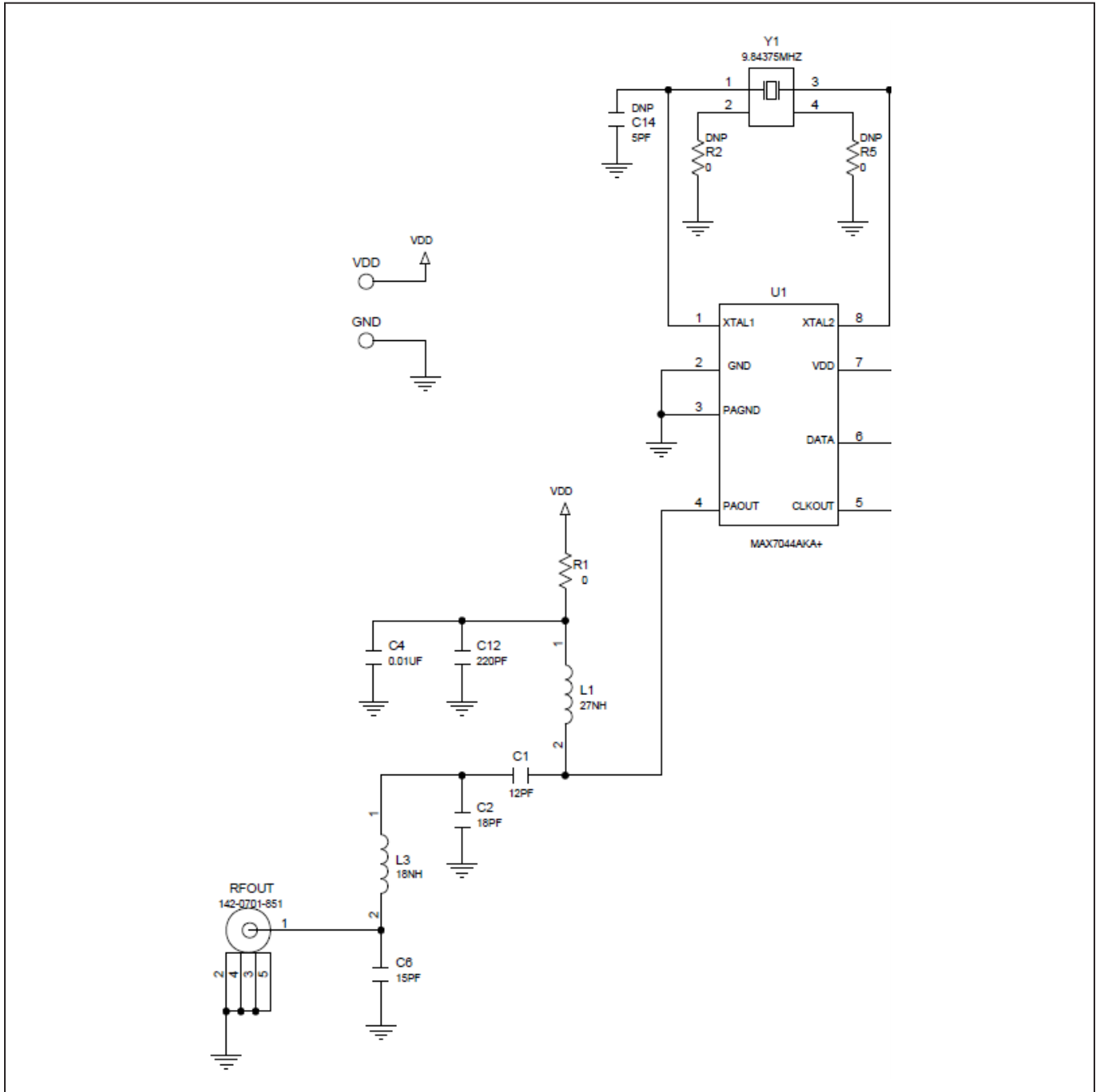

Figure A2-2. Matching Network

To change the tuning of the matching network, two inductors (L1 and L3) and three capacitors (C1, C2, and C6) should be adjusted according to [Table A2-1](#).

Table A2-1. MAX7044 EV Kit Matching Network Component Values

KIT	MAX7044EVKIT-315MHz	MAX7044EVKIT-433MHz
C1	12pF	15pF
C2	18pF	12pF
C6	15pF	12pF
L1	27nH	27nH
L3	18nH	16nH
Y1	9.84375MHz	13.56MHz

*Value affected by PCB layout.

PMOD Header Interface

The MAX7044 EV kit has a **PMOD-compatible header** footprint that provides yet another built-in interface to the transmitter. The JU4 connector can be populated with a 6-pin, 100mil, right-angle header such as a SAMTEC TSW-106-25-T-S-RA, allowing direct connections to the CLKOUT, DATA, ground, and VDD lines.

The PMOD interface can be used in combination with the Maxim MAX32600MBED kit and the MAXREFDES72# Arduino Uno R3-to-PMOD shield adaptor. When using the PMOD interface to supply the MAX7044 EV kit with power, make sure to connect the JU4 jumper between pins 2-3.

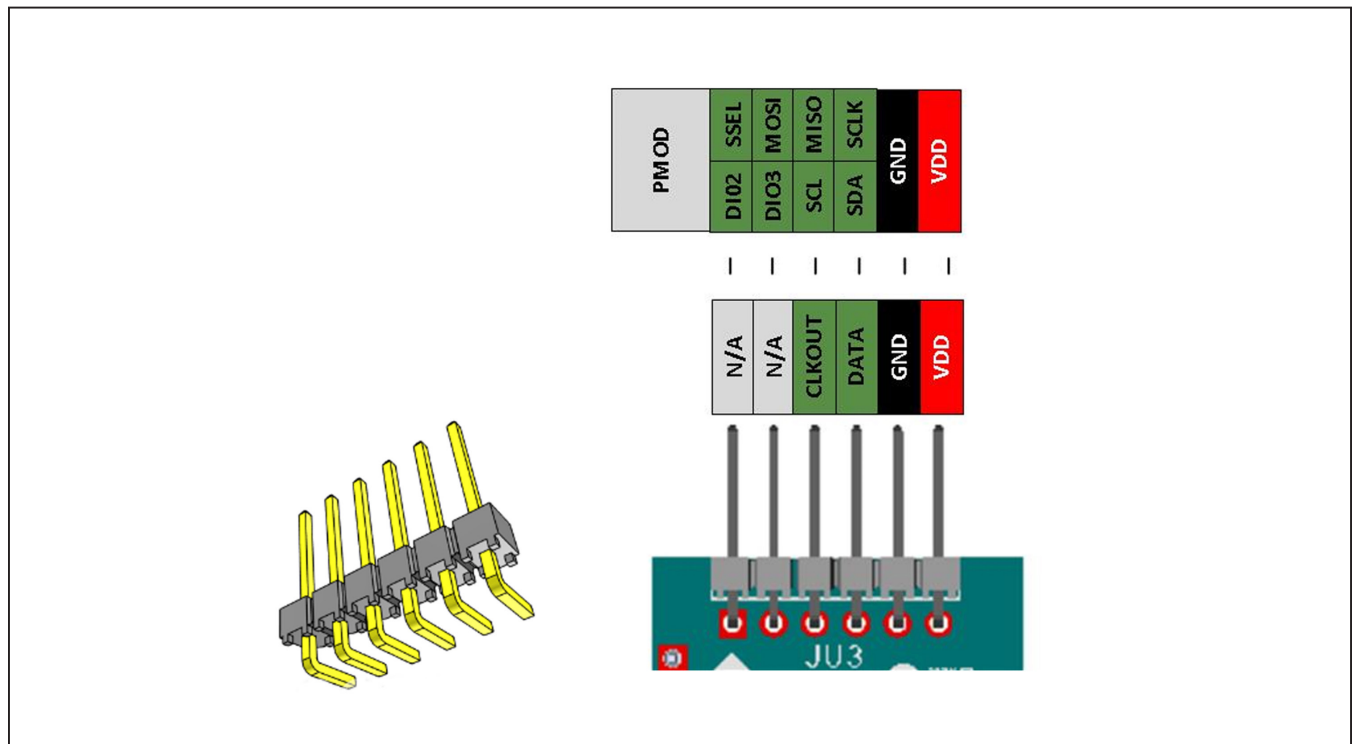
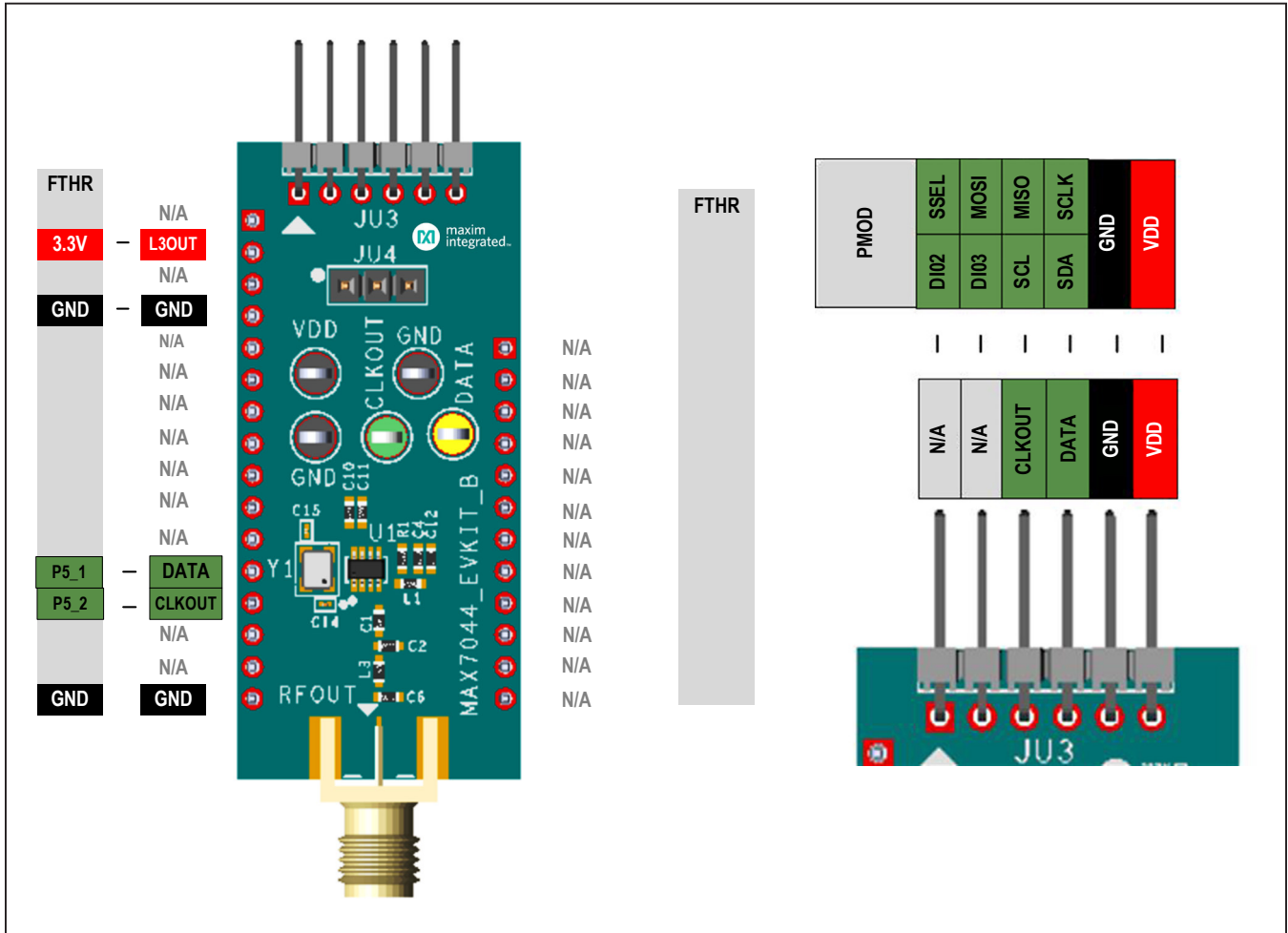

Figure A2-4. MAX7044 EV Kit PMOD Interface

Appendix III – Pinout Sheets

MAX7044EVKIT

300MHz to 450MHz ASK Transmitter



MAX32630FTHR

Arm Cortex-M4F Microcontroller Rapid Development Platform.

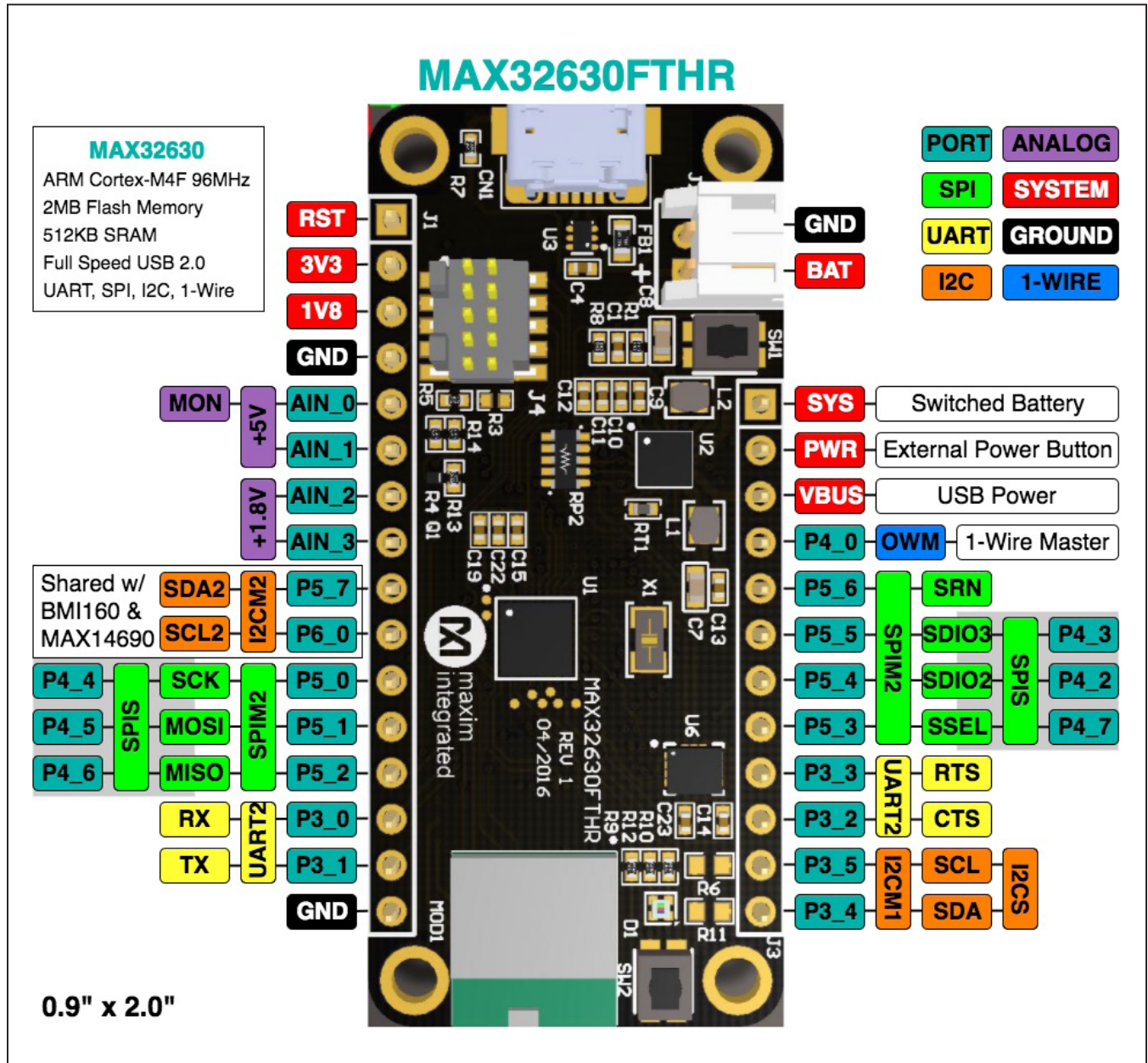

Revision History

REVISION NUMBER	REVISION DATE	DESCRIPTION	PAGES CHANGED
0	3/05	Initial release	—
1	2/12	Updated <i>Component List</i> and Figure 1	1, 4
2	1/21	Updated the entire EV kit	1–32
3	6/21	Updated the <i>Quick Start</i> section, updated <i>FTHR Board Quick Start Procedure – SPI and I²C Interface</i> section, replaced <i>Component list</i> and replaced <i>figure 12</i> , <i>MAX32630FTHR Board Photo</i> , and <i>MAX7044 ASK Transmitter Photo</i>	2–11, 30, 31

For pricing, delivery, and ordering information, please visit Maxim Integrated's online storefront at <https://www.maximintegrated.com/en/storefront/storefront.html>.

Maxim Integrated cannot assume responsibility for use of any circuitry other than circuitry entirely embodied in a Maxim Integrated product. No circuit patent licenses are implied. Maxim Integrated reserves the right to change the circuitry and specifications without notice at any time.