

Evaluating the AD9523-1 Clock Generator

FEATURES

- Simple power connection using USB connection and on-board LDO voltage regulators
- LDOs are easily bypassed for power measurements
- AC-coupled differential SMA connectors
- SMA connectors for
 - 2 reference inputs
 - 2 PLL status outputs
 - 1 reference test input
 - 2 VCXO interface inputs/outputs
- Microsoft Windows®-based evaluation software with simple graphical user interface
- On-board PLL loop filter
- Easy access to digital I/O and diagnostic signals via I/O header
- Status LEDs for diagnostic signals
- USB computer interface
- Software calculator provides flexibility, allowing programming of almost any rational input/output frequency ratio

GENERAL DESCRIPTION

This user guide describes the hardware and software of the [AD9523-1](#) evaluation boards. The evaluation board schematic and PCB layout artwork can be found at www.analog.com.

The AD9523-1 is designed to support the clock requirements for long-term evolution (LTE) and multicarrier GSM base station designs. It relies on an external VCXO to provide the reference jitter cleanup to achieve the restrictive low phase noise requirements necessary for acceptable data converter SNR performance. The AD9523-1 evaluation board is a compact, easy-to-use platform for evaluating all features of the AD9523-1. A 122.88 MHz VCXO is mounted on the evaluation board to provide a complete solution.

The input receivers are configured as differential but the evaluation board has baluns to provide a single-ended input for easy evaluation using common laboratory single-ended signal sources. Output 8 is connected to an [ADCLK905](#) clock buffer to provide a way to evaluate an Analog Devices, Inc., buffer. Although the ADCLK905 is a 1-to-1 buffer, the performance is similar to the larger fanout buffer, for example, the 1-to-2 buffer, ADCLK925. Output 1 and Output 9 are configured with baluns to provide a single-ended output to drive most test equipment. Output 0 is configured for differential zero delay operation.

DIGITAL PICTURE OF EVALUATION BOARD

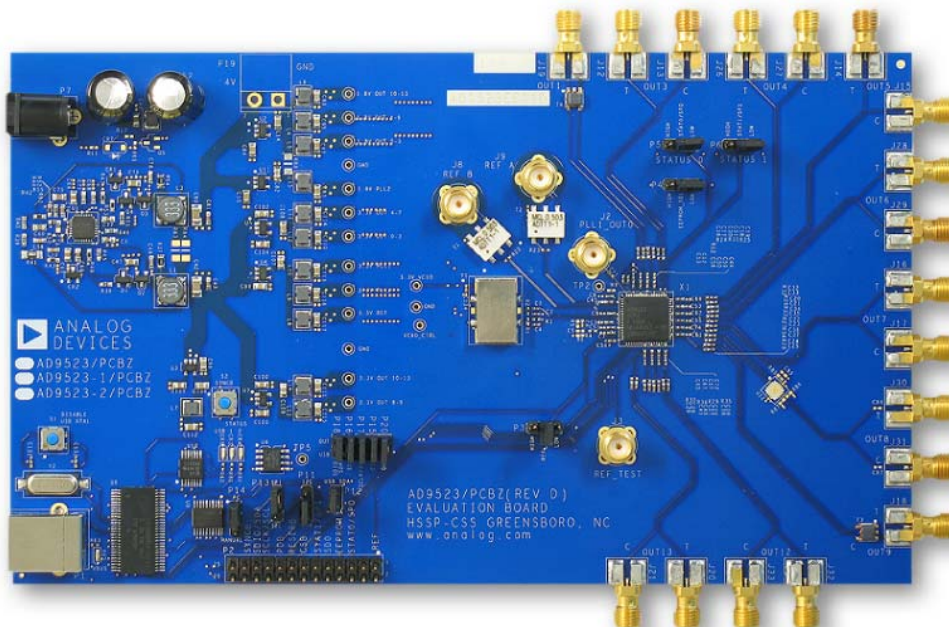

Figure 1. AD9523-1 Evaluation Board

09280-001

TABLE OF CONTENTS

Features	1	Evaluation Board Software Operation.....	6
General Description	1	Menu Bar of Main Window	7
Digital Picture of Evaluation Board	1	Using the Software to Control the Functional Blocks of	
Revision History	2	AD9523-1	8
Evaluation Board Hardware.....	3	PLL 1 Controls.....	8
Setting Up Jumper Connections.....	3	PLL 2 Controls.....	9
Setting Up the Power and PC Connections	3	Channel Divider Window	10
Setting Up the Signal Connections	3	Output Driver Window	11
Setting Up the PLL2 Loop Filter Capacitor	3	EEPROM Control	11
Bypassing the 6 V Wall Socket Power Supply.....	3	Using the Evaluation Board to Program an AD9523-1 on a	
Using I ² C Serial Port Mode	4	Customer Board.....	12
Evaluation Board Software Setup	5	Quick Start Guide to the AD9523-1	13
Installing the Software	5		
Using the Software.....	5		

REVISION HISTORY

10/10—Revision 0: Initial Version

EVALUATION BOARD HARDWARE

The following instructions are for setting up the physical connections to the AD9523-1 evaluation board.

SETTING UP JUMPER CONNECTIONS

The evaluation board is configured for proper PC control and operation. If the jumpers are inadvertently moved, use Figure 2 and Figure 3 to reconfigure the board.

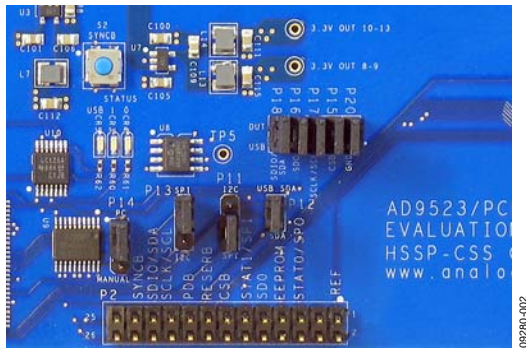

Figure 2. USB and SPI Jumper Connections

SETTING UP THE POWER AND PC CONNECTIONS

Set up the power and PC connections as follows:

1. Install the AD9523-1 evaluation software before connecting the evaluation board to the PC for the first time (see the Installing the Software section). Administrative privileges are required for installation.
2. Connect the 6 V wall adapter to Connector P7 of the evaluation board.
3. Connect the USB cables to the evaluation board and the computer.
4. **Found New Hardware Wizard** automatically appears when the evaluation board is connected. Select **Install the software automatically** and then click **Next**.

The **Found New Hardware Wizard** may appear twice, and a system restart may be required.

Refer to the Evaluation Board Software Setup section for details on running the AD9523-1 evaluation board software.

SETTING UP THE SIGNAL CONNECTIONS

After setting up the power and PC connections, use the following procedure to set up the signal connections:

1. Connect a signal generator to REF A SMA Connector J9. By default, the reference inputs on this evaluation board are ac-coupled and terminated with 50 Ω to ground. An amplitude setting of 6 dBm is sufficient.
2. Connect an oscilloscope, spectrum analyzer, or other lab equipment to any of the OUTx SMA connectors on the right side of the board. The output connectors are single-ended outputs of a differential pair. A 50 Ω termination should be placed on all unused differential output pairs.

SETTING UP THE PLL2 LOOP FILTER CAPACITOR

PLL2 requires an external loop filter capacitor. To achieve the best jitter performance, reference Capacitor C6 to LDO_VCO, Pin 12. This can be done by installing R6 and removing R4. These connections should have been performed at the factory.

BYPASSING THE 6 V WALL SOCKET POWER SUPPLY

The evaluation board contains a dc-to-dc converter to step down the 6 V to 2.2 V and 4 V. Linear regulators are then used to further regulate the 2.2 V to 1.8 V supply domain and the 4 V to the 3.3 V supply domain. The evaluation board can be configured to bypass the dc-to-dc converter and linear regulators or the dc-to-dc converter only. This is useful for measuring AD9523-1 power consumption. Refer to the evaluation board schematics provided on the CD in the evaluation board kit (also available at www.analog.com) for further details.

Bypass the 6 V power supply (dc-to-dc converter and linear regulators) as follows:

1. Note that it is very important to not have the 6 V supply connected to the evaluation board while using external supplies. To be safe, remove the inductors from each linear regulator output (L4 to L15).
2. Connect a bench power supply to each of the supply pins on Header TP3 through Header TP15. If the inductors were not removed in Step 1, then some of the supply pins are connected together on the evaluation board and damage to the external supply and/or evaluation board may occur.

Bypass the 6 V power supply (dc-to-dc converter only) as follows:

1. Remove L1, L2, L3, R39, R41, R40, and R42.
2. Connect a 2.2 V bench supply to Connector P19.
3. Connect a 4 V bench supply to the L1 pad.

EVALUATION BOARD SOFTWARE SETUP

The instructions included in this section are for setting up the AD9523-1 evaluation board software.

INSTALLING THE SOFTWARE

Do not connect the evaluation board until the software installation is complete. To install the software,

1. Insert the AD9523-1 evaluation software CD-ROM into a PC CD disc drive.
2. Click **My Computer**, and then double-click the **AD9523-1EV CD** icon.
A window opens showing the contents of the CD divided into four sections: data sheet, layout, schematic, and software. The **readme.txt** file contains a description of the CD-ROM contents, as well as any last minute instructions or information.
3. Double-click the **Software** folder, and then double-click **AD9523-1Eval_Setup1.1.0.exe**. Follow the installation instructions.
The default location for the evaluation software is **C:\Program Files\Analog Devices\AD9523-1 Eval Software**.
4. If there are any updates to the evaluation software on a supplemental CD or in the **\Software\Updates** folder, be sure to copy the new .exe file, as well as any setup files, to the default location.

USING THE SOFTWARE

After the evaluation software has been installed, you can run the software as follows:

1. Power up and connect the evaluation board to the PC.
2. Double-click **AD9523-1 Eval Software** to run the AD9523-1 evaluation software.
A hardware installation window appears. Depending on whether the evaluation board was found by the software, the text in this window is either light blue, indicating that the evaluation board was found, or red, indicating that the evaluation board was not found.
3. If the evaluation board was found, click in the window when the **Evaluation Software Ready** message appears.

The main window of the evaluation board software appears. Proceed to the Evaluation Board Software Operation section for more details about using the software.

4. If the evaluation board was not found, a dialog box appears that allows you to select an evaluation board to use while the software runs in standalone mode. Standalone mode is useful for viewing and generating register setup files.
 - a. If the evaluation board was not automatically detected when it was connected, choose **Select Evaluation Board** from the **I/O** menu, and then select **Ezssp-0**, **Ezssp-1**, or **Ezssp-2** (see Figure 4).

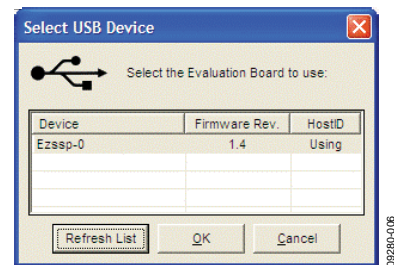

Figure 4. Select USB Device Window

5. If you connect the evaluation board while the evaluation board software is running, the window shown in Figure 5 usually appears to prompt you to load the evaluation board with the evaluation board software settings or to read the current evaluation board settings into the software.

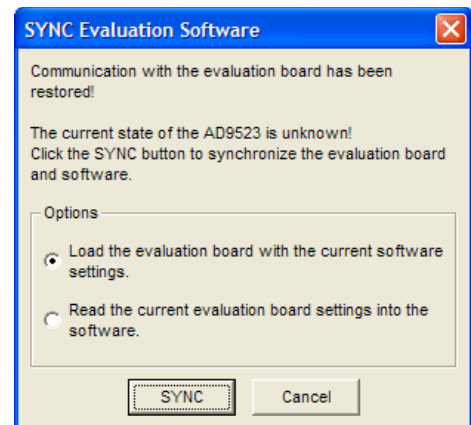

Figure 5. SYNC Evaluation Software Window

EVALUATION BOARD SOFTWARE OPERATION

The main window of the AD9523-1 evaluation board software comprises subsections that correspond to the major functional blocks of the AD9523-1 (see Figure 6). These subsections, most of which have their own window, are outlined in this section. From the main window, the window for each functional block can be accessed by clicking the appropriate box.

When a subsection window closes after clicking **OK**, the **WRITE** button under **REGISTER W/R** on the main window may start blinking. This indicates that there are settings that have not been loaded to the AD9523-1 evaluation board. Click **WRITE** to load these settings to the evaluation board.

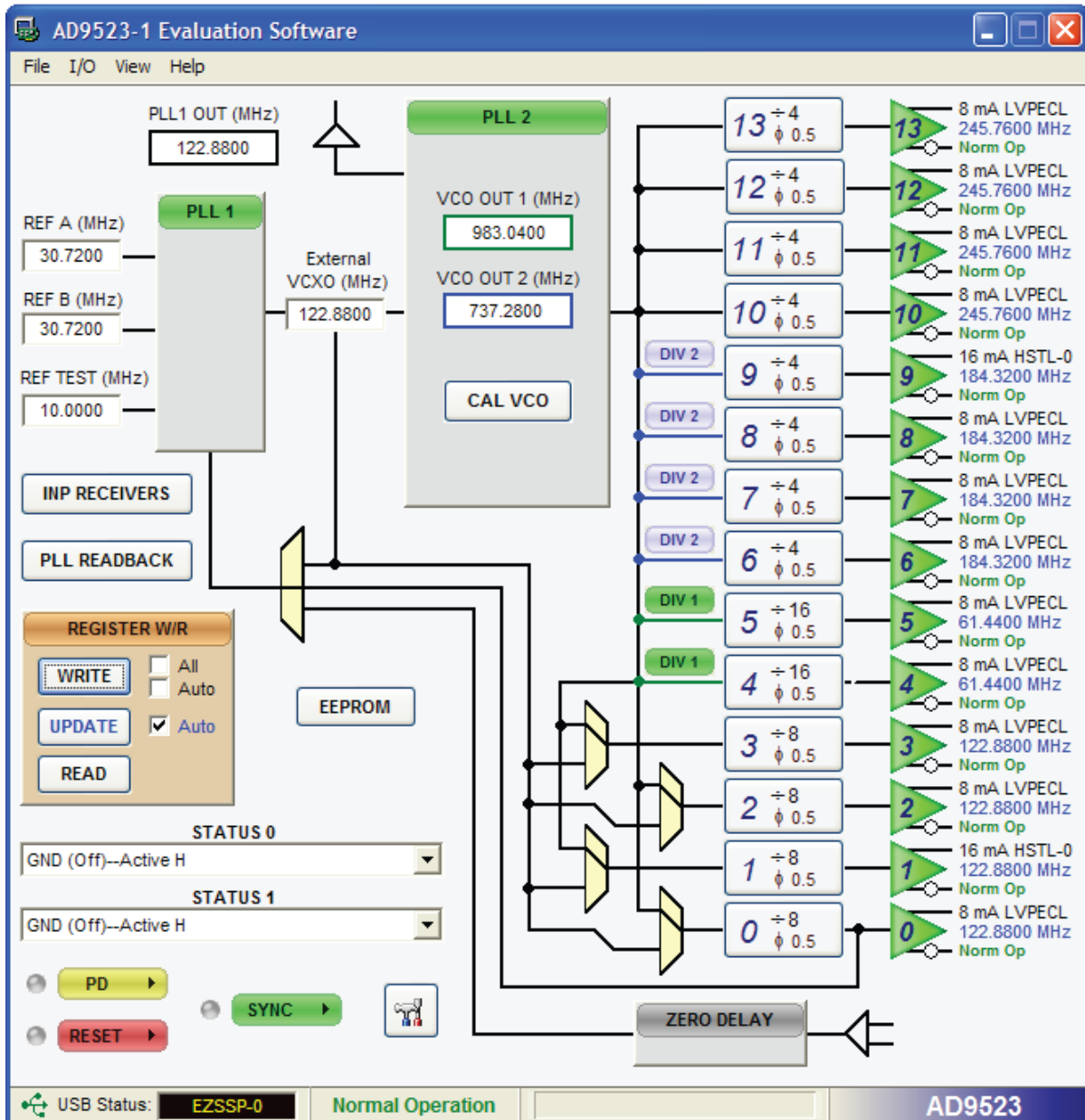

Figure 6. AD9523-1 Evaluation Software Main Window

MENU BAR OF MAIN WINDOW

File Menu

The **File** menu allows you to load a previously saved AD9523-1 setup file or to save a new AD9523-1 setup file. A setup file (.stp) is a text file that contains the AD9523-1 register setup file, plus any evaluation board settings.

To load a previously saved setup file, select **Load Setup** from the **File** menu. Note that you must still perform a VCO calibration. Alternatively, to save a new setup file, select **Save Setup** from the **File** menu.

To exit the evaluation software, select **Exit** from the **File** menu. However, note that you must save your setup before exiting; no checking is performed to ensure that the existing setup is saved.

I/O Menu

The AD9523-1 evaluation system allows one PC to control multiple evaluation boards. The **Select USB Device** window, accessed by choosing **Select Evaluation Board** from the **I/O** menu, allows you to select which evaluation board the software controls (see Figure 7). Click **Refresh List** to detect a recently connected evaluation board.

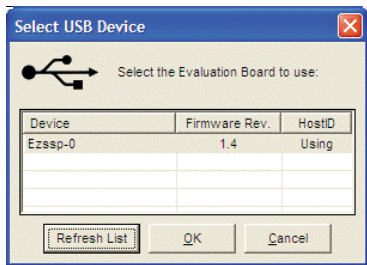

Figure 7. Select USB Device Window

Selecting **Configure Serial Port** from the **I/O** menu allows you to control how the USB controller interacts with the AD9523-1 serial port (see Figure 8) by configuring Register 0x0000 (shown as **0000h** in Figure 10).

The serial port configuration window allows you to control how the USB controller interacts with the AD9523-1 serial port. If you are using I²C mode, this window allows you to select which address to use. Note that it needs to correspond to the settings of Jumpers P5 and P6 on the evaluation board. You can also click the **Detect Current Configuration** button to have the evaluation software discover which I²C address is active.

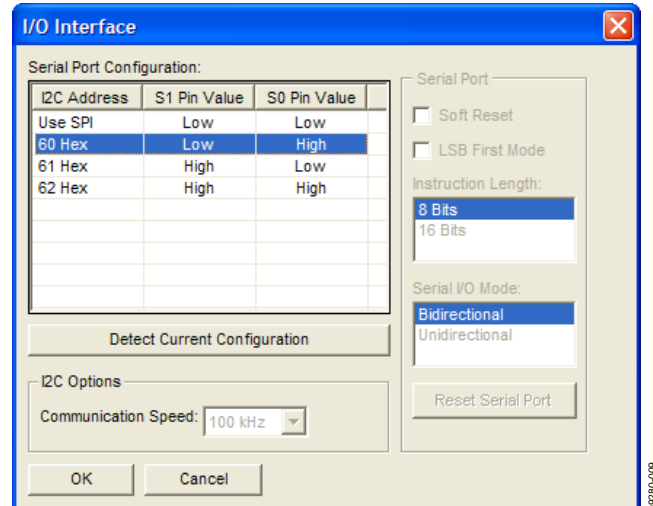

Figure 8. Serial Port Configuration Window

View Menu

The **Debug** window, accessed by selecting **Debug Window** from the **View** menu, allows you to write and read registers directly and to force the various configuration pins high or low (see Figure 9).

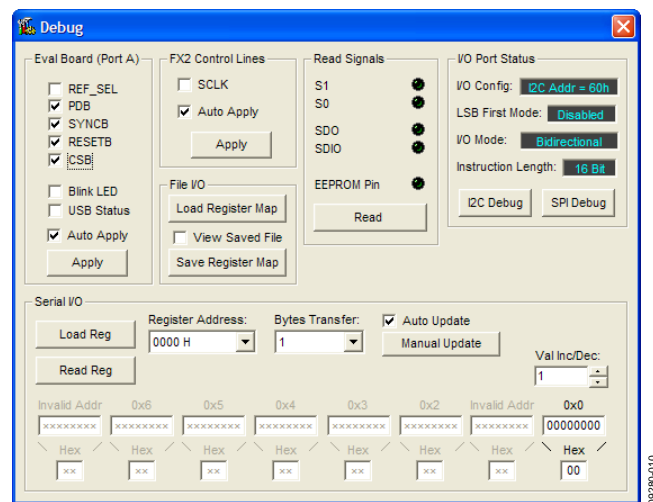

Figure 9. Debug Window

The **Register Map Values** window, accessed by selecting **Register Map Window** from the **View** menu, allows you to read registers (see Figure 10).

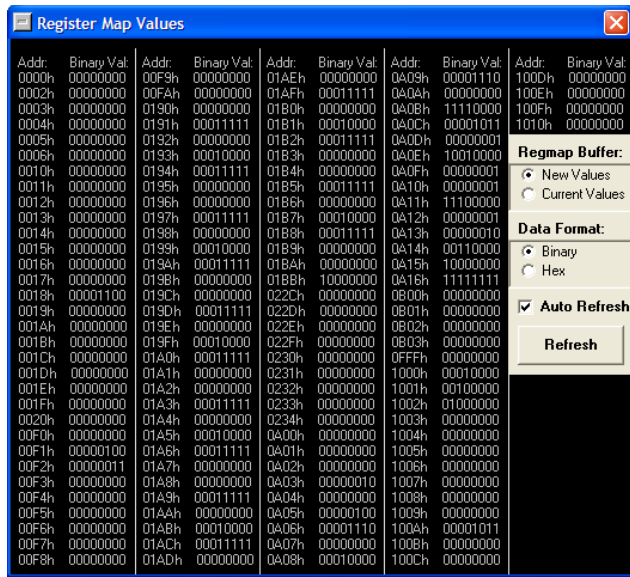

Figure 10. Register Map Window

Help Menu

Selecting **Help** from the **Help** menu opens the **About AD9523-1** window, which contains information such as revision number, region information, and contact information.

USING THE SOFTWARE TO CONTROL THE FUNCTIONAL BLOCKS OF AD9523-1

REGISTER W/R

The **REGISTER W/R** (write/read) section in Figure 6 has three buttons and three check boxes.

The **WRITE** button transfers the values stored in the evaluation software to the evaluation board. It blinks red when register values have changed.

The **READ** button transfers the values stored in the evaluation board to the evaluation software.

The **UPDATE** button issues an I/O update command by writing to the I/O update register.

Selecting the **All** check box transfers all of the registers when the **WRITE** button is clicked. When this box is not selected, only the registers whose value has changed are written.

Selecting the **Auto** check box adjacent to the **WRITE** button forces the evaluation software to write the register changes to the evaluation board automatically when they occur.

Selecting the **Auto** check box adjacent to the **UPDATE** box forces the evaluation software to issue an I/O update command whenever registers are written to the AD9523-1.

SYNC, PD (Power Down), and RESET

The **SYNC**, **PD**, and **RESET** buttons allow you to control the **SYNC**, **PD**, and **RESET** pins on the AD9523-1.

Each button has three options: **Strobe**, **Latch**, and **Release**. **Strobe** activates the pin and then releases it. **Latch** holds the pin active until the **Release** command is issued.

PLL 1 CONTROLS

The **PLL 1** box in the main window (see Figure 6) allows you to configure the PLL1 parameters. Clicking the **PLL 1** box in the main window, shown in Figure 11, opens a window to allow configuration of PLL1 (see Figure 12).

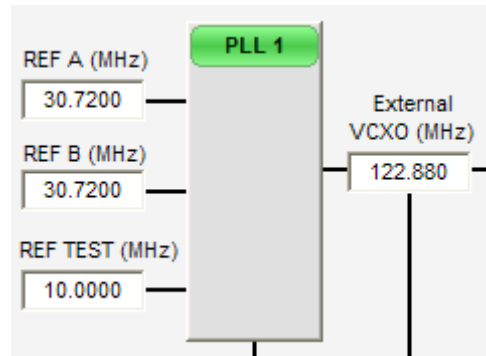

Figure 11. PLL 1 Box (in Main Window)

Clicking each individual box in the **PLL 1 Controls** window opens a new window to allow configuration of that block (see Figure 13 for an example for the **REF A Divider** window).

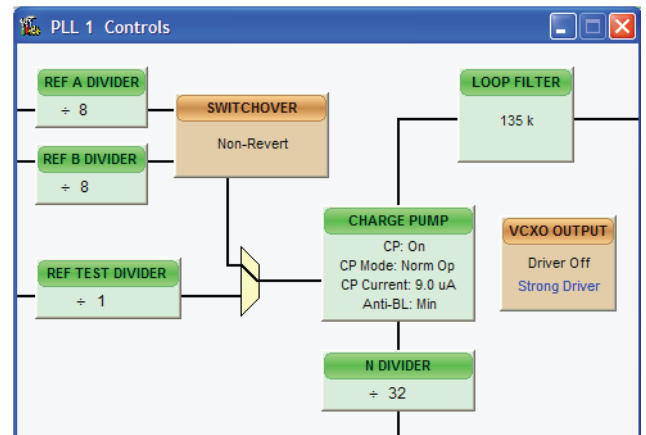

Figure 12. PLL 1 Controls Window

Reference (REF) Divider Window

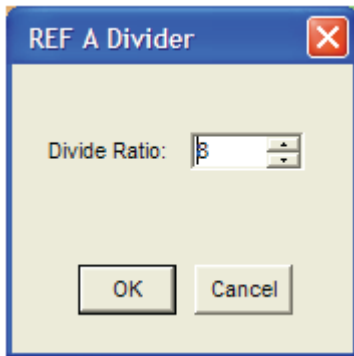

Figure 13. Reference A or Reference B Divider Window

The reference divider window shown in Figure 13 is accessed by clicking the REF A Divider box in Figure 12. It allows you to set the reference divider. There is a corresponding window for both REF A and REF B dividers.

Feedback (N) Divider Window

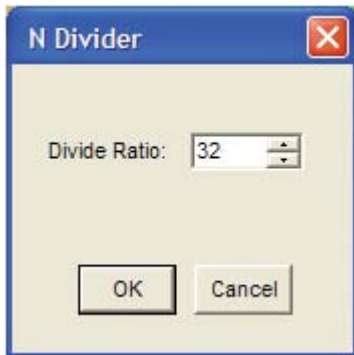

Figure 14. N Divider Window

The feedback divider window shown in Figure 14 is accessed by clicking the N DIVIDER box in Figure 12. It allows you to set the feedback divider.

Charge Pump Window

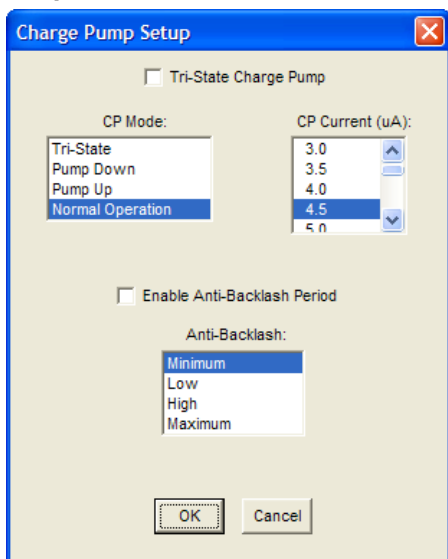

Figure 15. Charge Pump Window

The Charge Pump Setup window shown in Figure 15 is accessed by clicking the CHARGE PUMP box in Figure 12. This window is most often used to vary the charge pump current.

PLL 2 CONTROLS

Clicking the PLL 2 box from the main window (see Figure 16) opens a window to allow configuration of PLL 2 (see Figure 17).

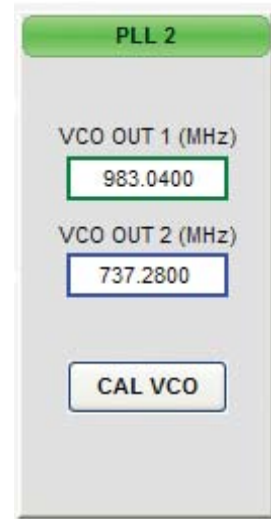

Figure 16. PLL 2 Box (in Main Window)

Clicking each individual box in the PLL 2 Controls window opens a new window to allow configuration of that block.

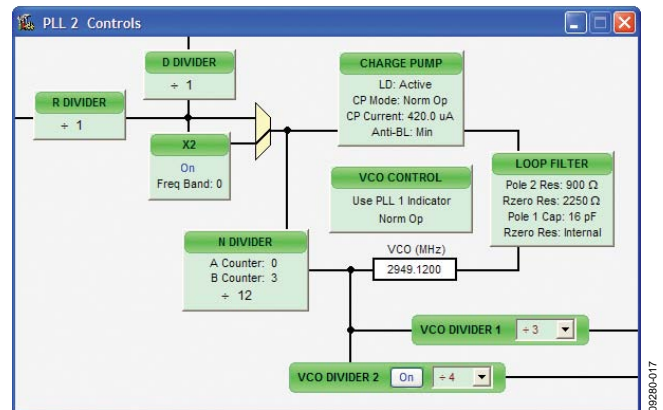

Figure 17. PLL 2 Controls Window

Feedback (N) Divider Window

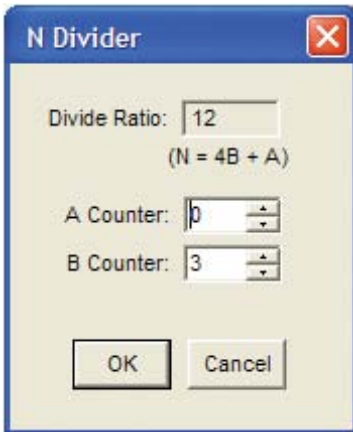

Figure 18. N Divider Window

The **N Divider** window shown in Figure 18 is accessed by clicking the **N DIVIDER** box in Figure 17. It allows you to set the feedback divider.

VCO Divider 1 and Divider 2

The VCO dividers controls are located in the **PLL 2 Controls** window shown in Figure 17. They allow you to set the frequency feeding the channels. Channel OUT4 through Channel OUT9 can be configured for either Divider 1 or Divider 2. If Divider 2 is not required, it is recommended that it be turned off for best spurious performance.

Charge Pump Window

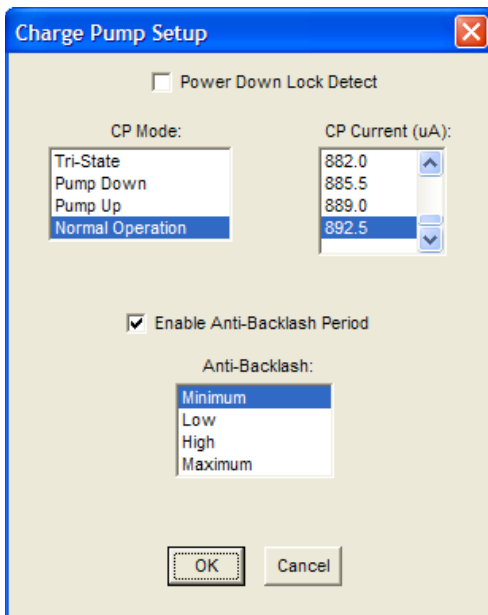

Figure 19. Charge Pump Window

The **Charge Pump Setup** window shown in Figure 19 is accessed by clicking the **CHARGE PUMP** box in Figure 17.

This window is most often used to vary the charge pump current.

CHANNEL DIVIDER WINDOW

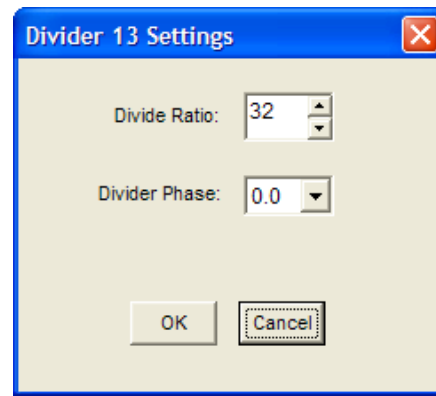

Figure 20. Channel Divider Window

The channel divider window shown in Figure 20 is accessed by clicking the appropriate channel divider (see Figure 21) in the main window shown in Figure 6. It is usually sufficient to change only the divide ratio, because the evaluation software and the AD9523-1 duty cycle correction feature ensure that the output duty cycle remains very close to 50%.

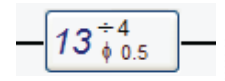

Figure 21. Channel Divider

You can also vary the phase offset by changing the phase offset bits setting under the **Divider Phase** box in Figure 20. However, for the new phase to take effect, the **SYNC** signal must be toggled, by clicking the **SYNC** button shown in Figure 22 and selecting **Strobe SyncB**.

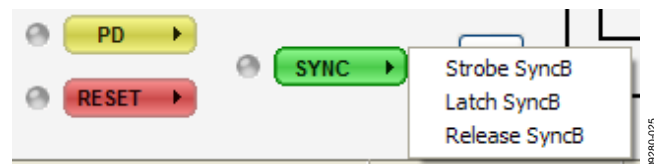

Figure 22. Toggling SYNC Signal

OUTPUT DRIVER WINDOW

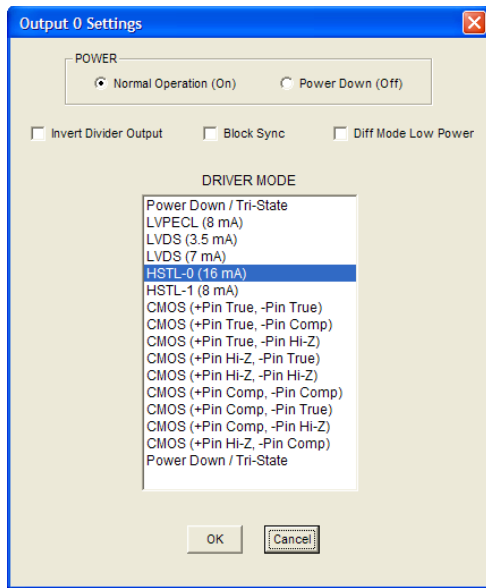

Figure 23. Output Driver Window

The output driver window shown in Figure 23 is accessed by clicking any of the triangular output driver symbols on the right side of the main window (see Figure 24).

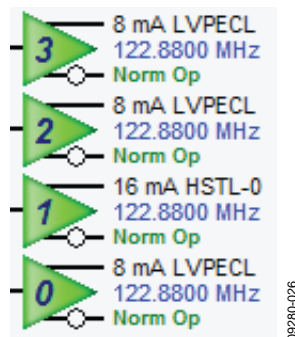

Figure 24. Output Drivers

It is important to power down unused outputs on the evaluation board because they can be a major source of unwanted spurs.

The outputs are ac-coupled with 100 Ω differential resistors on each output. This termination scheme is ideal for LVPECL drivers. However, this scheme degrades the CMOS driver performance. Improved CMOS driver performance is achieved by removing the 100 Ω resistors.

EEPROM CONTROL

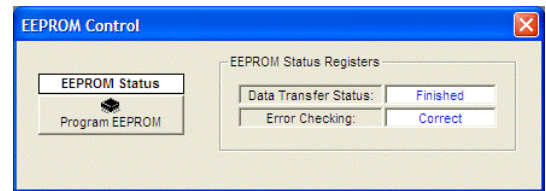

Figure 25. EEPROM Control Window

The **EEPROM Control** window shown in Figure 25 is accessed by clicking the **EEPROM** button near the lower left quadrant of the main window.

To store the current register settings of the AD9523-1 to the EEPROM, click the **Program EEPROM** button. Visually confirm the **EEPROM Status Registers** section on the right side of the window to verify that the operation is successful.

To load the values stored in the EEPROM,

1. Disconnect the 6 V power connector to power down the AD9523-1.
2. Ensure that the EEPROM pin is pulled high by placing the P4 EEPROM_SEL jumper of the evaluation board across the center and left (high) pin (see Figure 3).
3. Reconnect the 6 V power supply. This automatically loads the EEPROM settings into the AD9523-1. The programmed settings can be observed at the outputs. In addition, a window opens (see Figure 26). Click the second option to read from the AD9523-1. This loads the control software with the current register settings that were programmed by the EEPROM.

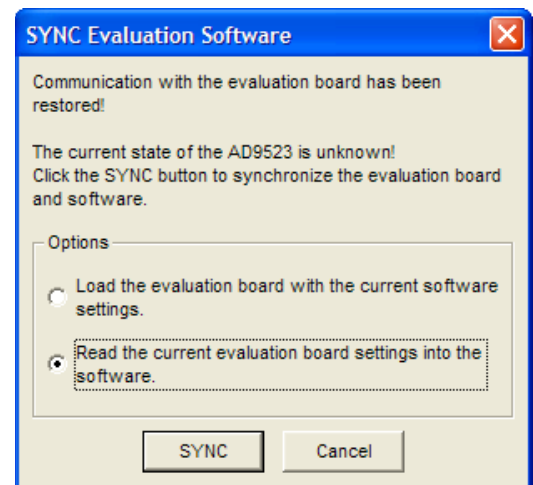

Figure 26. SYNC Evaluation Software Window

USING THE EVALUATION BOARD TO PROGRAM AN AD9523-1 ON A CUSTOMER BOARD

This guide explains how to use an AD9523-1 evaluation board to program an AD9523-1 on a customer board via the I²C interface. It assumes that the user has access to the I²C pins via a header on the target board, and knows the assigned address of the target I²C device.

1. Move Jumpers P13 and P11 to the **I²C** position.
2. Select the desired I²C address for the AD9523-1 evaluation board using Jumper P5 and Jumper P6. Note that the P5 = P6 = low setting is reserved for SPI mode. Also, this I²C address should not conflict with the I²C address of the target AD9523-1.
3. Attach a jumper cable from the SDIO_SDA pin of Header P2 of the evaluation board to the SDA pin on the target board.
4. Repeat Step 3 for both the SCLK_SCL pin and the GND pin of the AD9523-1 evaluation board, attaching jumper cables to the SCL pin and ground pin of the target board, respectively.
5. On the evaluation software, select **Configure Serial Port** from the I/O menu. This window is shown in Figure 27.

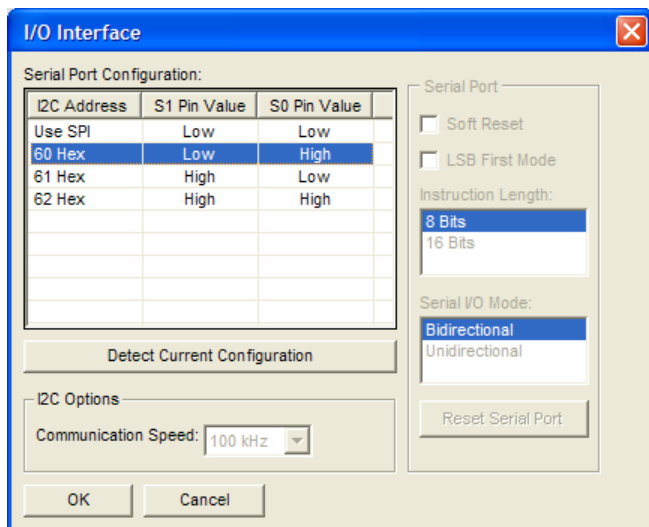

Figure 27. Evaluation Software Serial Port Configuration

6. Click **Reset Serial Port** and then click **Detect Current Configuration**. A dialog box appears and acknowledges the I²C mode and address. The evaluation software starts at I²C Address 0x060 and stops at the first valid I²C address that it finds. If the target I²C address is different from the one automatically selected, select the I²C address of the target AD9523-1 from the list, and click **OK**.
7. From the **View** menu on the menu bar, select **Debug Window**. From the **Debug** window (see Figure 9), click the **I²C Debug** button under the **I/O Port Status** section. The window shown in Figure 28 appears.

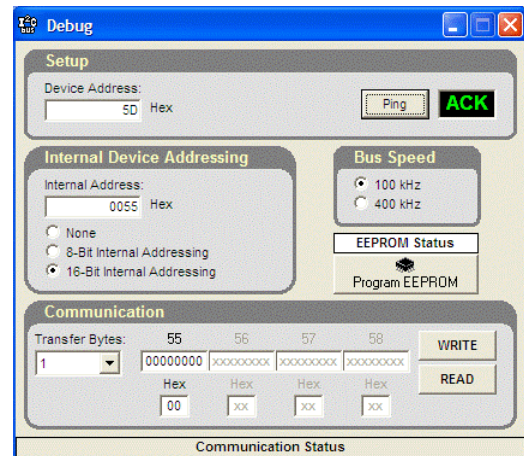

Figure 28. Evaluation Software I²C Debug Window

8. Enter the I²C address set by Jumper P5 and Jumper P6 on the AD9523-1 evaluation board, and click **Ping**. The user should see a green **ACK** message as shown in Figure 28. Repeat this step for the I²C address of the target AD9523-1. If **ACK** is returned for both addresses, the remote AD9523-1 is ready to be programmed. If the ping test fails, double-check the cabling between the boards, as well as the I²C address of the target AD9523-1. Ensure that the I²C address of the AD9523-1 on the evaluation board is different from the target AD9523-1. Also, disconnect the jumper cable, and make sure that I²C mode is working properly on the AD9523-1 evaluation board.
9. Proceed to program the target AD9523-1 with the desired settings.
 - a. When finished, click the **EEPROM** button on the main window to access the EEPROM window.
 - b. Click **Program EEPROM** to write the settings to the EEPROM.

QUICK START GUIDE TO THE AD9523-1

The AD9523-1 can be initialized at startup from either the EEPROM or from SPI settings. The AD9523-1 evaluation board ships with initial settings programmed in the EEPROM. It is advised that the user first use the preprogrammed EEPROM settings before proceeding onto software control.

To load the values stored in the EEPROM:

1. Ensure that the EEPROM pin is pulled high by placing the P4 EEPROM_SEL jumper of the evaluation board across the center and left (high) pin (see Figure 3).
2. Connect a signal generator to REF A SMA Connector J9. By default, the reference inputs on this evaluation board are ac-coupled and terminated with 50 Ω to ground. An amplitude setting of 6 dBm is sufficient and the frequency should be 30.72 MHz.
3. Connect an oscilloscope, spectrum analyzer, or other lab equipment to the OUT1 SMA connector on the right side of the board. This output connector is a single-ended output of a differential pair.
4. Connect the 6 V power supply. This automatically loads the EEPROM settings into the AD9523-1 (the EEPROM configurations are similar as shown in Figure 6).

To load the provided setup file:

1. Follow the instructions provided in the Evaluation Board Software Setup section.
2. Ensure that the EEPROM pin is pulled low by placing the P4 EEPROM_SEL jumper of the evaluation board across the center and right (low) pin (see Figure 3).
3. Connect a signal generator to REF A SMA Connector J9. By default, the reference inputs on this evaluation board are ac-coupled and terminated with 50 Ω to ground. An amplitude setting of 6 dBm is sufficient and the frequency should be 30.72 MHz.
4. Connect the 6 V power supply.
5. Provided on the CD is a setup file named **AD9523-1_983plan_122p88MHz_VCXO_DoublerON.stp** located in the **Setup Files** directory. Load this setup file using the **File** menu from the main software window. The main window should appear as shown in Figure 6.
6. Click the **CAL VCO** button located in the **PLL 2** box of Figure 6.
7. Connect an oscilloscope, spectrum analyzer, or other lab equipment to the OUT1 SMA connector on the right side of the board. This output connector is a single-ended output of a differential pair. A picture of phase noise profile is located in the same directory as the setup file with the same file name (with the .png extension).

NOTES

NOTES

NOTES

**ESD Caution**

ESD (electrostatic discharge) sensitive device. Charged devices and circuit boards can discharge without detection. Although this product features patented or proprietary protection circuitry, damage may occur on devices subjected to high energy ESD. Therefore, proper ESD precautions should be taken to avoid performance degradation or loss of functionality.

Legal Terms and Conditions

By using the evaluation board discussed herein (together with any tools, components documentation or support materials, the "Evaluation Board"), you are agreeing to be bound by the terms and conditions set forth below ("Agreement") unless you have purchased the Evaluation Board, in which case the Analog Devices Standard Terms and Conditions of Sale shall govern. Do not use the Evaluation Board until you have read and agreed to the Agreement. Your use of the Evaluation Board shall signify your acceptance of the Agreement. This Agreement is made by and between you ("Customer") and Analog Devices, Inc. ("ADI"), with its principal place of business at One Technology Way, Norwood, MA 02062, USA. Subject to the terms and conditions of the Agreement, ADI hereby grants to Customer a free, limited, personal, temporary, non-exclusive, non-sublicensable, non-transferable license to use the Evaluation Board FOR EVALUATION PURPOSES ONLY. Customer understands and agrees that the Evaluation Board is provided for the sole and exclusive purpose referenced above, and agrees not to use the Evaluation Board for any other purpose. Furthermore, the license granted is expressly made subject to the following additional limitations: Customer shall not (i) rent, lease, display, sell, transfer, assign, sublicense, or distribute the Evaluation Board; and (ii) permit any Third Party to access the Evaluation Board. As used herein, the term "Third Party" includes any entity other than ADI, Customer, their employees, affiliates and in-house consultants. The Evaluation Board is NOT sold to Customer; all rights not expressly granted herein, including ownership of the Evaluation Board, are reserved by ADI. CONFIDENTIALITY. This Agreement and the Evaluation Board shall all be considered the confidential and proprietary information of ADI. Customer may not disclose or transfer any portion of the Evaluation Board to any other party for any reason. Upon discontinuation of use of the Evaluation Board or termination of this Agreement, Customer agrees to promptly return the Evaluation Board to ADI. ADDITIONAL RESTRICTIONS. Customer may not disassemble, decompile or reverse engineer chips on the Evaluation Board. Customer shall inform ADI of any occurred damages or any modifications or alterations it makes to the Evaluation Board, including but not limited to soldering or any other activity that affects the material content of the Evaluation Board. Modifications to the Evaluation Board must comply with applicable law, including but not limited to the RoHS Directive. TERMINATION. ADI may terminate this Agreement at any time upon giving written notice to Customer. Customer agrees to return to ADI the Evaluation Board at that time. LIMITATION OF LIABILITY. THE EVALUATION BOARD PROVIDED HEREUNDER IS PROVIDED "AS IS" AND ADI MAKES NO WARRANTIES OR REPRESENTATIONS OF ANY KIND WITH RESPECT TO IT. ADI SPECIFICALLY DISCLAIMS ANY REPRESENTATIONS, ENDORSEMENTS, GUARANTEES, OR WARRANTIES, EXPRESS OR IMPLIED, RELATED TO THE EVALUATION BOARD INCLUDING, BUT NOT LIMITED TO, THE IMPLIED WARRANTY OF MERCHANTABILITY, TITLE, FITNESS FOR A PARTICULAR PURPOSE OR NON-INFRINGEMENT OF INTELLECTUAL PROPERTY RIGHTS. IN NO EVENT WILL ADI AND ITS LICENSORS BE LIABLE FOR ANY INCIDENTAL, SPECIAL, INDIRECT, OR CONSEQUENTIAL DAMAGES RESULTING FROM CUSTOMER'S POSSESSION OR USE OF THE EVALUATION BOARD, INCLUDING BUT NOT LIMITED TO LOST PROFITS, DELAY COSTS, LABOR COSTS OR LOSS OF GOODWILL. ADI'S TOTAL LIABILITY FROM ANY AND ALL CAUSES SHALL BE LIMITED TO THE AMOUNT OF ONE HUNDRED US DOLLARS (\$100.00). EXPORT. Customer agrees that it will not directly or indirectly export the Evaluation Board to another country, and that it will comply with all applicable United States federal laws and regulations relating to exports. GOVERNING LAW. This Agreement shall be governed by and construed in accordance with the substantive laws of the Commonwealth of Massachusetts (excluding conflict of law rules). Any legal action regarding this Agreement will be heard in the state or federal courts having jurisdiction in Suffolk County, Massachusetts, and Customer hereby submits to the personal jurisdiction and venue of such courts. The United Nations Convention on Contracts for the International Sale of Goods shall not apply to this Agreement and is expressly disclaimed.