

# KSA1242

KSA1242

## Medium Power Amplifier Camera Flash Applications

- $h_{FE} = 100\sim 320$  ( $V_{CE} = -2V$ ,  $I_C = -0.5V$ )
- $h_{FE} = 70$  (Min.) ( $V_{CE} = -2V$ ,  $I_C = -4A$ )
- Low Saturation Voltage:  $V_{CE(sat)} = -1V$  (Max.)

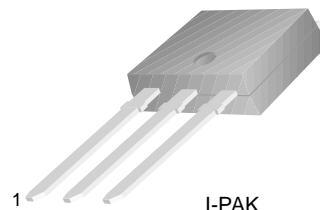

I-PAK  
1. Base 2. Collector 3. Emitter

## PNP Epitaxial Silicon Transistor

### Absolute Maximum Ratings $T_C=25^\circ C$ unless otherwise noted

Symbol	Parameter	Ratings	Units
$V_{CBO}$	Collector-Base Voltage	- 35	V
$V_{CEO}$	Collector-Emitter Voltage	- 20	V
$V_{EBO}$	Emitter-Base Voltage	- 8	V
$I_C$	Collector Current (DC)	- 5	A
$I_{CP}$	Collector Current (Pulse)	- 8	A
$P_C$	Collector Dissipation ( $T_C=25^\circ C$ )	10	W
$T_J$	Junction Temperature	150	$^\circ C$
$T_{STG}$	Storage Temperature	- 55 ~ 150	$^\circ C$

### Electrical Characteristics $T_C=25^\circ C$ unless otherwise noted

Symbol	Parameter	Test Condition	Min.	Typ.	Max.	Units
$BV_{CEO}$	Collector-Emitter Breakdown Voltage	$I_C = -10mA$ , $I_B = 0$	- 20			V
$BV_{EBO}$	Emitter-Base Breakdown Voltage	$I_E = -1mA$ , $I_C = 0$	- 8			V
$I_{CBO}$	Collector Cut-off Current	$V_{CB} = -35V$ , $I_E = 0$			- 100	$\mu A$
$I_{EBO}$	Emitter Cut-off Current	$V_{EB} = -8V$ , $I_C = 0$			- 100	$\mu A$
$h_{FE1}$ $h_{FE2}$	DC Current Gain	$V_{CE} = -2V$ , $I_C = -0.5A$ $V_{CE} = -2V$ , $I_C = -4A$	100 70		320	
$V_{CE(sat)}$	Collector-Emitter Saturation Voltage	$I_C = -4A$ , $I_B = -0.1A$			- 1	V
$V_{BE(on)}$	Base-Emitter On Voltage	$V_{CE} = -2V$ , $I_C = -4A$			- 1.5	V
$f_T$	Current Gain Bandwidth Product	$V_{CE} = -2V$ , $I_C = -0.5A$		180		MHz
$C_{ob}$	Collector Output Capacitance	$V_{CB} = -10V$ , $f = 1MHz$		50		pF

### $h_{FE}$ Classification

Classification	O	Y
$h_{FE1}$	100 ~ 200	160 ~ 320

# Typical Characteristics

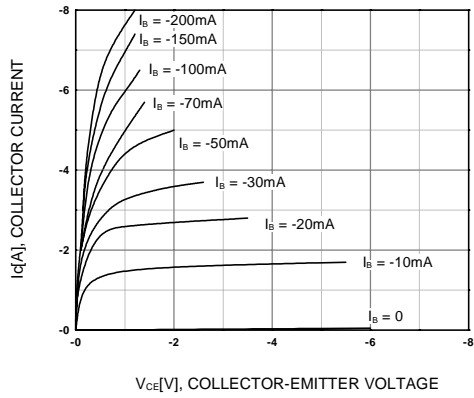

Figure 1. Static Characateristic

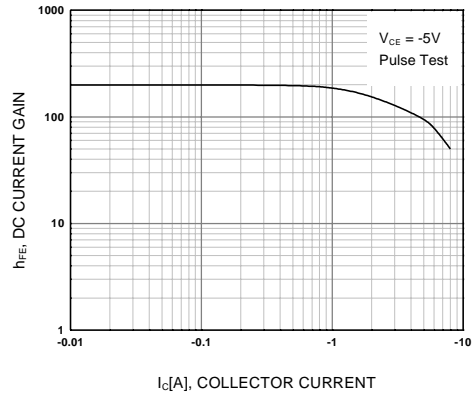

Figure 2. DC current Gain

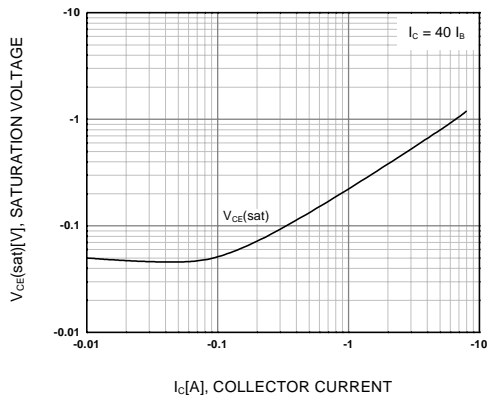

Figure 3. Collector-Emitter Saturation Voltage

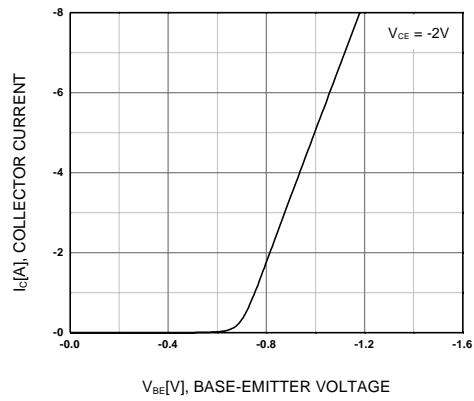

Figure 4. Base-Emitter On Voltage

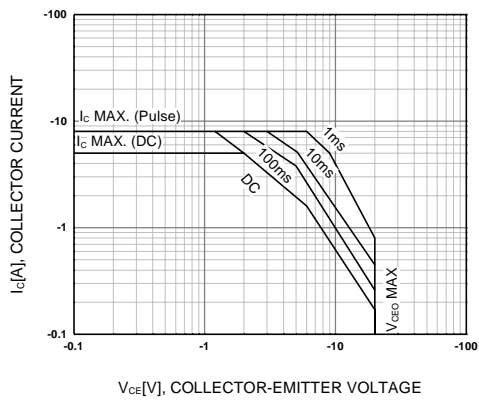

Figure 5. Safe Operating Area

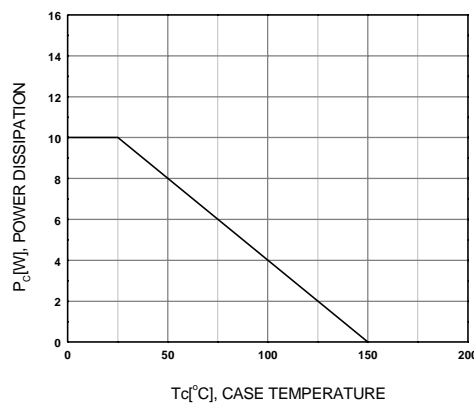
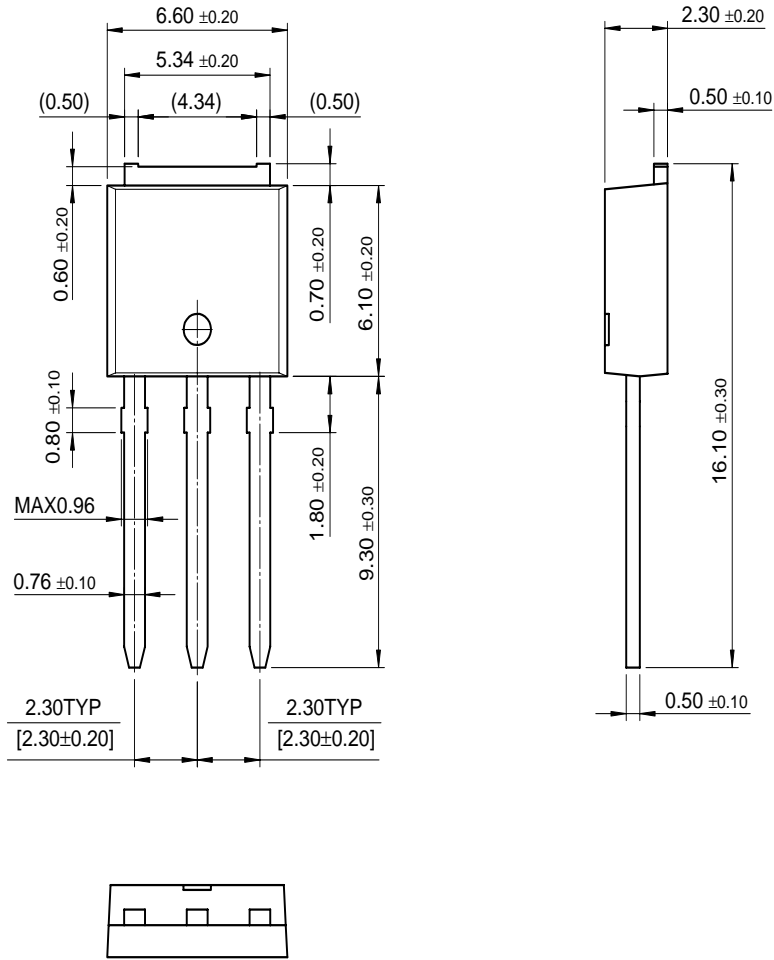

Figure 6. Power Derating

# Package Dimensions

## I-PAK



Dimensions in Millimeters

## TRADEMARKS

The following are registered and unregistered trademarks Fairchild Semiconductor owns or is authorized to use and is not intended to be an exhaustive list of all such trademarks.

ACEx™	FAST®	OPTOPLANAR™	STAR*POWER™
Bottomless™	FASTr™	PACMAN™	Stealth™
CoolFET™	FRFET™	POP™	SuperSOT™-3
CROSSVOLT™	GlobalOptoisolator™	Power247™	SuperSOT™-6
DenseTrench™	GTO™	PowerTrench®	SuperSOT™-8
DOMET™	HiSeC™	QFET™	SyncFET™
EcoSPARK™	ISOPLANAR™	QS™	TruTranslation™
E <sup>2</sup> CMOS™	LittleFET™	QT Optoelectronics™	TinyLogic™
EnSigna™	MicroFET™	Quiet Series™	UHC™
FACT™	MICROWIRE™	SLIENT SWITCHER®	UltraFET®
FACT Quiet Series™	OPTOLOGIC™	SMART START™	VCX™

STAR\*POWER is used under license

## DISCLAIMER

FAIRCHILD SEMICONDUCTOR RESERVES THE RIGHT TO MAKE CHANGES WITHOUT FURTHER NOTICE TO ANY PRODUCTS HEREIN TO IMPROVE RELIABILITY, FUNCTION OR DESIGN. FAIRCHILD DOES NOT ASSUME ANY LIABILITY ARISING OUT OF THE APPLICATION OR USE OF ANY PRODUCT OR CIRCUIT DESCRIBED HEREIN; NEITHER DOES IT CONVEY ANY LICENSE UNDER ITS PATENT RIGHTS, NOR THE RIGHTS OF OTHERS.

## LIFE SUPPORT POLICY

FAIRCHILD'S PRODUCTS ARE NOT AUTHORIZED FOR USE AS CRITICAL COMPONENTS IN LIFE SUPPORT DEVICES OR SYSTEMS WITHOUT THE EXPRESS WRITTEN APPROVAL OF FAIRCHILD SEMICONDUCTOR CORPORATION.

As used herein:

- Life support devices or systems are devices or systems which, (a) are intended for surgical implant into the body, or (b) support or sustain life, or (c) whose failure to perform when properly used in accordance with instructions for use provided in the labeling, can be reasonably expected to result in significant injury to the user.
- A critical component is any component of a life support device or system whose failure to perform can be reasonably expected to cause the failure of the life support device or system, or to affect its safety or effectiveness.

## PRODUCT STATUS DEFINITIONS

### Definition of Terms

Datasheet Identification	Product Status	Definition
Advance Information	Formative or In Design	This datasheet contains the design specifications for product development. Specifications may change in any manner without notice.
Preliminary	First Production	This datasheet contains preliminary data, and supplementary data will be published at a later date. Fairchild Semiconductor reserves the right to make changes at any time without notice in order to improve design.
No Identification Needed	Full Production	This datasheet contains final specifications. Fairchild Semiconductor reserves the right to make changes at any time without notice in order to improve design.
Obsolete	Not In Production	This datasheet contains specifications on a product that has been discontinued by Fairchild semiconductor. The datasheet is printed for reference information only.

Fairchild Semiconductor

SEARCH | [Parametric](#) | [Cross Reference](#) | [Inventory](#)

[space](#) [Product Folders and](#) [Applie](#)

find products

[Home](#) >> [Find products](#) >>

- [Products groups](#)
- [Analog and Mixed](#)
- [Signal](#)
- [Discrete](#)
- [Interface](#)
- [Logic](#)
- [Microcontrollers](#)
- [Non-Volatile](#)
- [Memory](#)
- [Optoelectronics](#)
- [Markets and applications](#)
- [New products](#)
- [Product selection and parametric search](#)
- [Cross-reference search](#)

KSA1242  
PNP Epitaxial Silicon Transistor

Contents  
[Features](#) | [Product status/pricing/packaging](#)

Features

**Medium Power Amplifier  
Camera Flash Applications**

- $h_{FE}=100\sim 320$  ( $V_{CE} = -2V, I_C = -0.5V$ )
- $h_{FE}=70$  (Min.) ( $V_{CE} = -2V, I_C = -4A$ )
- Low Saturation Voltage:  $V_{CE(sat)}=-1V$  (Max.)

Datasheet  
[Download this datasheet](#)

PDF

[e-mail this datasheet](#)

[E-]

This page  
[Print version](#)

**Related Links**

[Request samples](#)

[How to order products](#)

[Product Change Notices \(PCNs\)](#)

[Support](#)

[Distributor and field sales representatives](#)

[Quality and reliability](#)

[Design tools](#)

technical information

buy products

technical support

my Fairchild

company

[back to top](#)

Product status/pricing/packaging

Product	Product status	Pricing*	Inventory check & ordering	Package type	Leads	Packing method
KSA1242YTU	Full Production	\$0.393	<a href="#">Purchase</a>	TO-251(IPAK)	3	RAIL
KSA1242OTU	Full Production	\$0.393	<a href="#">Purchase</a>	TO-251(IPAK)	3	RAIL

\* Fairchild 1,000 piece Budgetary Pricing

[back to top](#)

[Home](#) | [Find products](#) | [Technical information](#) | [Buy products](#) | [Support](#) | [Company](#) | [Contact us](#) | [Site index](#) | [Privacy policy](#)

© Copyright 2002 Fairchild Semiconductor