



IR Emitter and Detector Product Data Sheet

HSDL-4261

Spec No.: DS50-2008-0026

Effective Date: 04/30/2013

Revision: A

LITE-ON DCC

RELEASE

BNS-OD-FC001/A4

FEATURES

- | | |
|------------------------------------|---|
| * High power AlGaAs LED technology | * Applications |
| * T-1 3/4 Package | Industrial IR Equipments |
| * 870 nm Wavelength | IR Portable Instruments |
| * High speed: 15ns Rise times | Consumer Electronics |
| * Low Forward Voltage | (Optical mouse ect) |
| | High Speed IR Communications |
| | (IR LANs , IR Moldens , IR Dongles , etc) |



PACKAGE DIMENSIONS

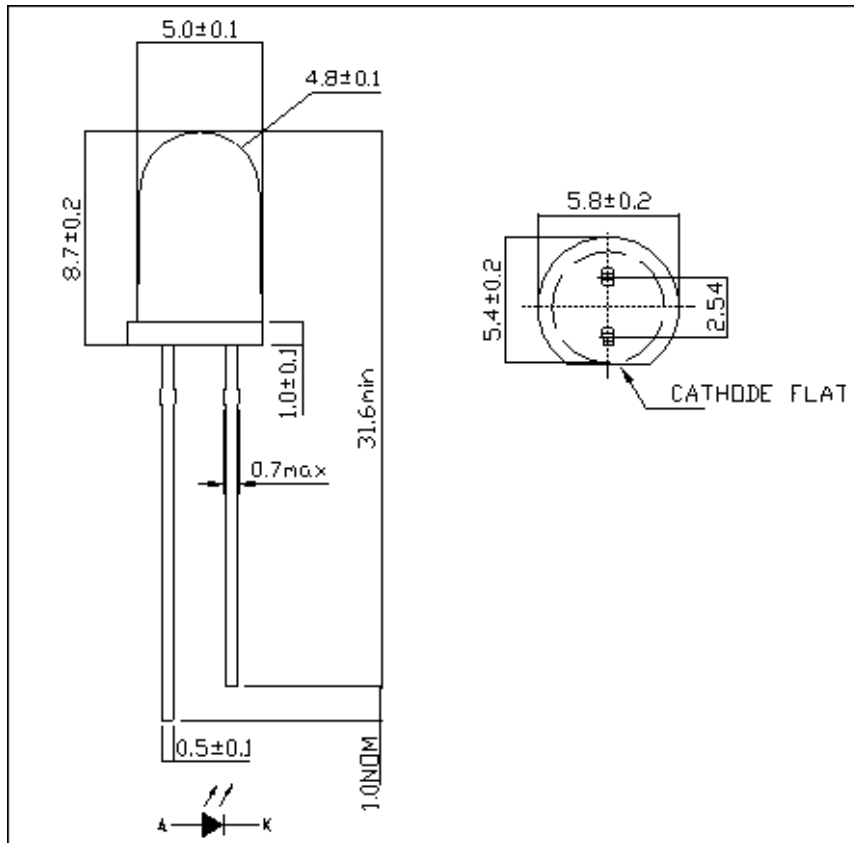

NOTES:

1. All dimensions are in millimeters (inches).
2. Tolerance is $\pm 0.25\text{mm} (.010\text{'})$ unless otherwise noted.
3. Protruded resin under flange is $1.5\text{mm} (.059\text{'})$ max.
4. Lead spacing is measured where the leads emerge from the package.
5. Specifications are subject to change without notice.



LITE-ON TECHNOLOGY CORPORATION.

Property of Lite-On Only

ABSOLUTE MAXIMUM RATINGS AT TA=25°C

PARAMETER	Symbol	MIN	MAX	UNIT	Reference
Forward Current	I _{FDC}		100	mA	[1],FIG.2
Power Dissipation	P _{DISS}		190	mW	
Reverse Voltage	V _R	5		V	IR=100uA
Storage Temperature	T _S	-40	100	°C	
LED Junction Temperature	T _J		110	°C	
Lead Soldering Temperature [1.6mm(.063") From Body]			260 for 5 seconds	°C	

Notes:

1.Derate as shown in Figure 6.

Recommended Operating Conditions

PARAMETER	Symbol	MIN	MAX	UNIT	Reference
Operating Temperature	T _O	-40	70	°C	



LITE-ON TECHNOLOGY CORPORATION.

Property of Lite-On Only

ELECTRICAL CHARACTERISTICS AT 25°C

PARAMETER	Symbol	MIN.	TYP.	MAX.	UNIT	TEST CONDITION	Reference
Forward Voltage	V_F		1.4	1.5	V	$I_{FDC} = 20\text{mA}$	Fig.2
			1.7	1.9	V	$I_{FDC} = 100\text{mA}$	Fig.3
Forward Voltage Temperature Coefficient	$\Delta V / \Delta T$	-	-1.5 -1.3	-	mV/°C	$I_{FDC} = 20\text{ mA}$ $I_{FDC} = 100\text{ mA}$	Fig.4
Series Resistance	R_s	-	4.1	-	0hms	$I_{FDC} = 100\text{mA}$	
Diode Capacitance	C_o	-	80	-	pF	0 V, 1 MHz	
Reverse Voltage	V_R	3	14	-	V	$I_R = 100\ \mu\text{A}$	
Thermal Resistance, Junction to Ambient	$R_{\theta_{ja}}$	-	280	-	°C/W		

OPTICAL CHARACTERISTICS AT TA=25°C

PARAMETER	Symbol	MIN.	TYP.	MAX.	UNIT	Test condition	Reference
Radiant Optical Power	P _O	-	9 45	-	mW	I _{FDC} = 20 mA I _{FDC} = 100mA	
Radiant On-Axis Intensity	I _E	17 87	36 180	-	mW /Sr	I _{FDC} = 20 mA I _{FDC} = 100mA	Fig.5
Radiant On-Axis Intensity Temperature Coefficient	$\Delta I_E / \Delta T$	-	-0.22	-	%/°C	I _{FDC} = 100mA	
Viewing Angle	2 $\theta_{1/2}$	-	26	-	deg	I _{FDC} = 20mA	Fig.7
Peak Wavelength	λ_{pk}	-	870	-	nm	I _{FDC} = 20mA	Fig.1
Peak Wavelength Temperature Coefficient	$\Delta \lambda / \Delta T$	-	0.18	-	nm/°C	I _{FDC} = 20mA	
Spectral Width-at FWHM	$\Delta \lambda$		47 52	-	nm	I _{FDC} = 20 mA I _{FDC} = 100mA	Fig.1
Optical Rise and all Times, 10%-90%	T _r / T _f f _c		15 23	-	Ns MHZ	I _{FDC} = 500 mA Duty Ratio=20% Pulse Width=100ns	

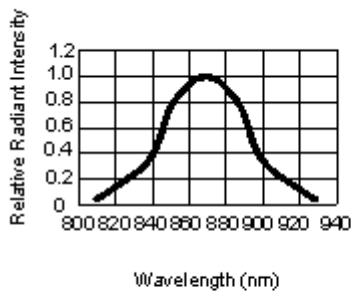

FIG.1 Relative Radiant Intensity VS Wavelength

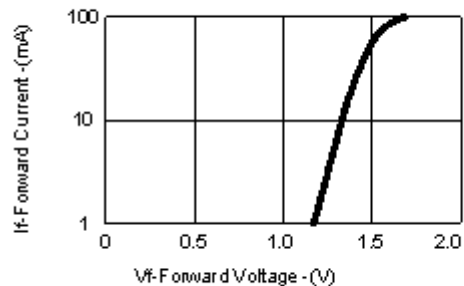

FIG.2 DC Forward Current VS. Forward Voltage

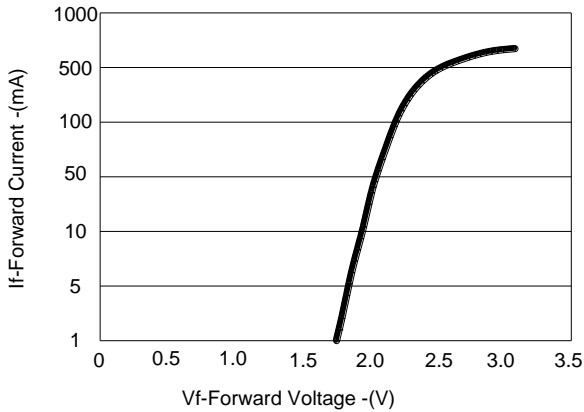

FIG.3 Peak Forward Current VS. Forward Voltage
Forward Current Vs Relative Radiant Intensity

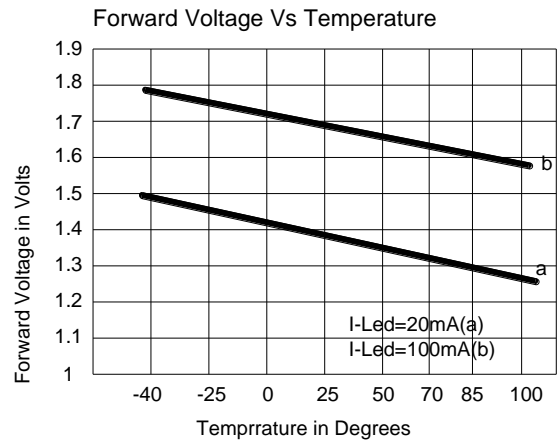

FIG.4 Forward Voltage VS. Ambient Temperature

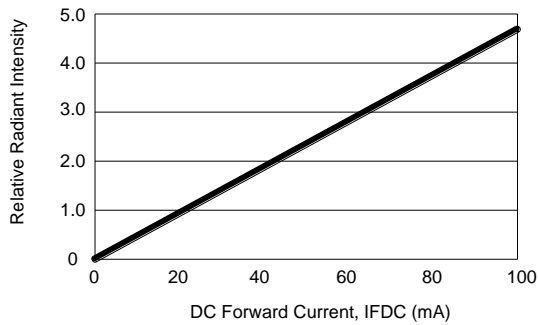

FIG.5 Relative Radiant Intensity vs DC Forward Current

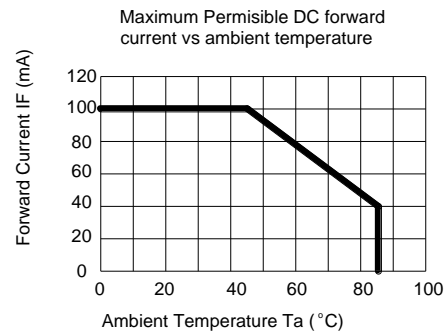

FIG.6 DC FORWARD CURRENT VS. AMBIENT TEMPERATURE DERATED (Based on TJMAX=110°C)

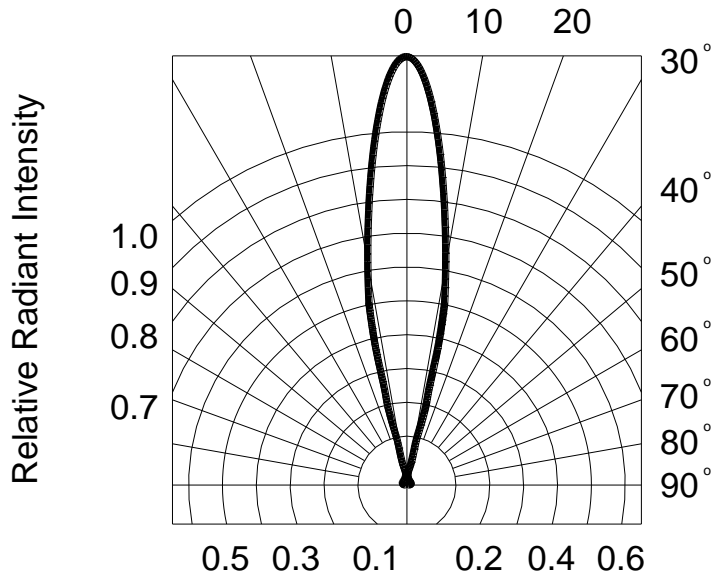

FIG.7 RADIATION DIAGRAM