

# General Specifications

## Electrical Capacity (Resistive Load)

**Power Level (code W):** 3A @ 125V AC

**Logic Level (code G):** 0.4VA maximum @ 28V AC/DC maximum  
(Applicable Range 0.1mA ~ 0.1A @ 20mV ~ 28V)

**Logic/Power Level (code A):** Combines W & G ratings

Note: See Supplement section to find explanation of operating range.

## Other Ratings

**Contact Resistance:** 20 milliohms maximum for silver; 30 milliohms maximum for gold

**Insulation Resistance:** 1,000 megohms minimum @ 500V DC

**Dielectric Strength:** 1,000V AC minimum between contacts for 1 minute minimum;  
1,500V AC minimum between contacts & case for 1 minute minimum

**Mechanical Life:** 200,000 operations minimum

**Electrical Life:** 25,000 operations minimum for silver; 100,000 operations minimum for gold

**Nominal Operating Force:** Single pole 2.45N; double pole 3.92N

**Travel:** Pretravel .024" (0.6mm); Overtravel .016" (0.4mm); Total Travel .039" (1.0mm)

## Materials & Finishes

**Plunger:** Brass with nickel plating

**Bushing:** Brass with nickel plating

**Mounting & Body Frames:** Stainless steel

**Support Bracket:** Brass with tin plating

**Case:** Polybutylene terephthalate (PBT) (UL94V-0)

**Base:** Diallyl phthalate resin

**Movable Contactor:** Phosphor bronze with silver or gold plating

**Movable Contacts:** Silver alloy (code W); copper with gold plating (code G)

**Stationary Contacts:** Silver with silver plating (code W); copper or brass with gold plating (code G)

**Terminals:** Copper with silver plating; copper or brass with gold plating

## Environmental Data

**Operating Temp Range:** -30°C through +85°C (-22°F through +185°F)

**Humidity:** 90 ~ 95% humidity for 100 hours @ 40°C (104°F)

**Vibration:** 10 ~ 55Hz with peak-to-peak amplitude of 1.5mm traversing the frequency range & returning in 1 minute; 3 right angled directions for 2 hours

**Shock:** 50G (490m/s<sup>2</sup>) acceleration (tested in 6 right angled directions, with 5 shocks in each direction)

## Installation

**Mounting Torque:** 1.5Nm (13 lb•in) for double nut; 0.7Nm (6 lb•in) for single nut

**Cap Installation Force:** 80N (18 lbf) maximum downward force on actuator

## Processing

**Soldering:** Wave Soldering Recommended: See Profile B in Supplement section.

Manual Soldering: See Profile B in Supplement section.

**Cleaning:** These devices are not process sealed. Hand clean locally using alcohol based solution.

## Standards & Certifications

**Flammability Standards:** UL94V-0 Case

**UL :** File No. E44145 - Recognized only when ordered with marking on switch.

Add "/U" or "/CUL" before dash in part number to order UL recognized switch.

All single & double pole models recognized at 3A @ 125V AC or 0.4VA max. @ 28V AC/DC max.

**CSA:** File No. 023535\_0\_000 - Certified only when ordered with marking on switch.

Add "/C" before dash in part number to order CSA certified switch.

Single pole & double pole models certified at 3A @ 125V AC or 0.4VA max. @ 28V AC/DC max.

# Distinctive Characteristics

Short stroke and light touch.

Antijamming design protects contacts from damage due to excessive downward force on the actuator.

High torque bushing construction prevents rotation or separation from frame during installation.

Stainless steel frame resists corrosion.

Longer center solder lug terminal simplifies wiring and soldering.

Patented silver contacts of specially composed alloy for hardness.

Epoxy sealed terminals prevent entry of solder flux and other contaminants.

Snap-acting mechanism gives smooth actuation and audible feedback.

Prominent external insulating barriers increase insulation resistance and dielectric strength.

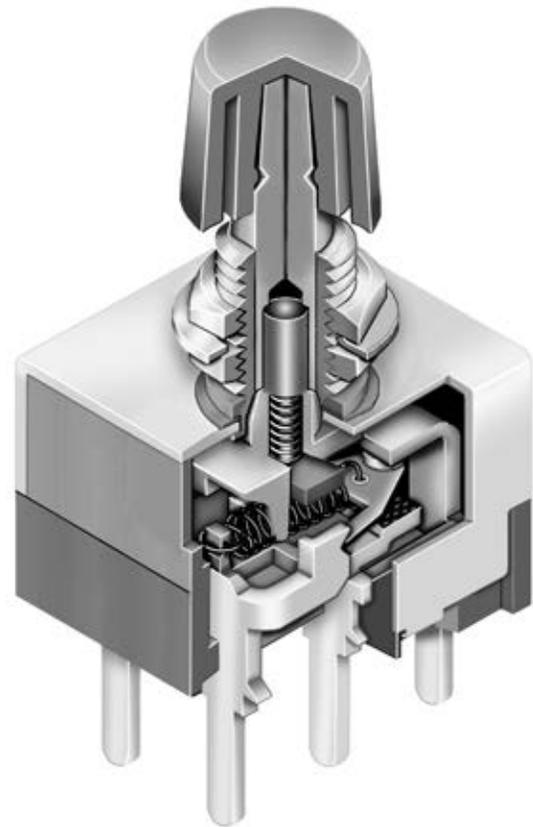

Actual Size

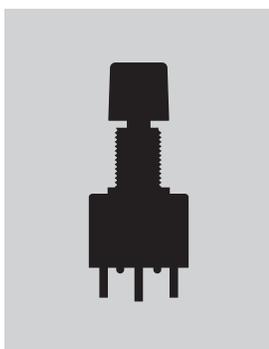

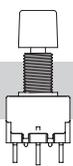
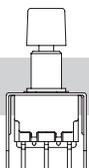
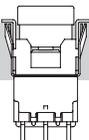
	Bushing Mount	Page C118
	Bracket PC Mount	Page C121
	Snap-in Mount	Page C124

- Toggle
- Rockers
- Pushbuttons**
- Illuminated PB
- Programmable
- Keylocks
- Rotaries
- Slides
- Tactiles
- Tilt
- Touch
- Indicators
- Accessories
- Supplement

### TYPICAL SWITCH ORDERING EXAMPLE

**MB25**

**11**

**S4**

**W**

**01**

**B**

**C**

#### Poles & Circuits

<b>11</b>	SPDT	ON	(ON)
<b>21</b>	DPDT	ON	(ON)

( ) = Momentary

#### Contact Materials & Ratings

<b>W</b>	Silver Rated 3A @ 125V AC
<b>G</b>	Gold Rated 0.4VA max @ 28V AC/DC max

#### Caps

<b>B</b>	.315" (8.0mm) Diameter
<b>C</b>	.394" (10.0mm) Diameter

#### Bushing

<b>S4</b>	.315" (8.0mm) Threaded with Keyway
-----------	---------------------------------------

#### Terminals

<b>01</b>	Solder Lug
<b>03</b>	.250" (6.35mm) Straight PC

#### Cap Colors

<b>A</b>	Black
<b>B</b>	White
<b>C</b>	Red
<b>E</b>	Yellow
<b>F</b>	Green
<b>G</b>	Blue

#### IMPORTANT:



Switches are supplied without UL, cULus & CSA marking unless specified.  
**UL, cULus & CSA recognized only when ordered with marking on the switch.**  
 Specific models, ratings, & ordering instructions are noted on the General Specifications page.

#### DESCRIPTION FOR TYPICAL ORDERING EXAMPLE

**MB2511S4W01-BC**

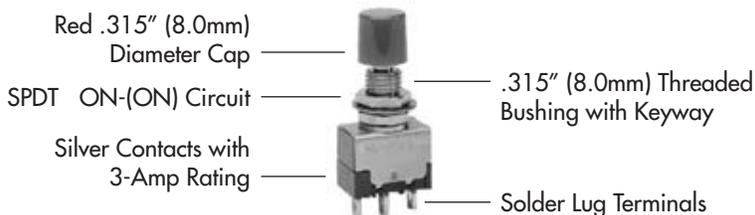

Toggles  
 Rockers  
 Pushbuttons  
 Illuminated PB  
 Programmable  
 Keylocks  
 Rotaries  
 Slides  
 Tactiles  
 Tilt  
 Touch  
 Indicators  
 Accessories  
 Supplement

## POLES & CIRCUITS

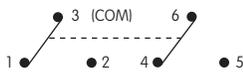
Pole	Model	Plunger Position ( ) = Momentary		Connected Terminals		Throw & Switch Schematics
		Normal  Keyway	Down 	Normal  Keyway	Down 	
SP	MB2511	ON	(ON)	3-1	3-2	SPDT 
DP	MB2521	ON	(ON)	3-1 6-4	3-2 6-5	DPDT 

Note: Terminal numbers are not actually on the switch.

## BUSHING

**S4** .315" (8.0mm)  
Threaded with Keyway

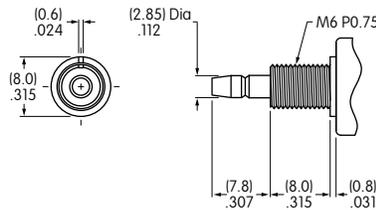

## Panel Cutouts

Without Keyway

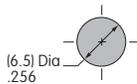

With Keyway

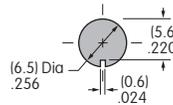

With Optional Locking Ring

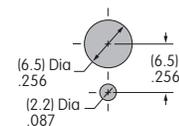

Maximum Panel Thickness with Standard Hardware: .134" (3.4mm)

## Standard Hardware

**AT513M** Threaded  
Hex Nut

2 included  
with each switch

Brass with  
nickel plating

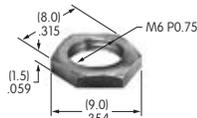

**AT509**  
Lockwasher

1 included  
with each switch

Steel with  
zinc/chromate

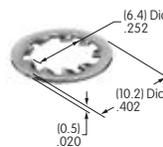

## Optional Hardware

**AT507M**  
Locking Ring

Steel with  
zinc/chromate

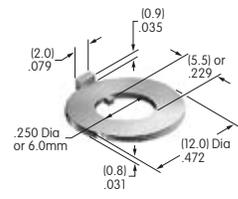

## CONTACT MATERIALS & RATINGS

**W** Silver over Silver

Power Level

3A @ 125V AC

**G** Gold over Brass or Copper

Logic Level

0.4VA maximum @ 28V AC/DC maximum

Note: Complete explanation of operating range in Supplement section.

Toggles  
Rockers  
Pushbuttons  
Illuminated PB  
Programmable  
Keylocks  
Rotaries  
Slides  
Tactiles  
Tilt  
Touch  
Indicators  
Accessories  
Supplement

Toggle

Rockers

Pushbuttons

Programmable Illuminated PB

Keylocks

Rotaries

Slides

Tactiles

Tilt

Touch

Indicators

Accessories

Supplement

## TERMINALS

**01** Solder Lug

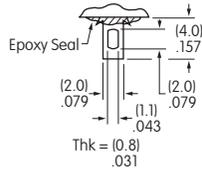

**03** .250" (6.35mm) Straight PC

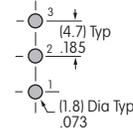
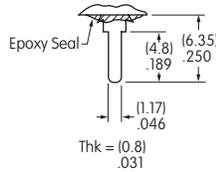

Single Pole

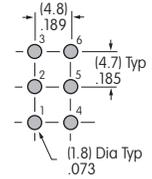

Double Pole

## CAPS & CAP COLORS

**B** AT443  
.315" (8.0mm) Diameter Cap

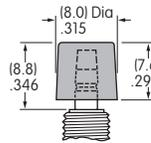

Material: Polycarbonate

Finish: Glossy

**C** AT442  
.394" (10.0mm) Diameter Cap

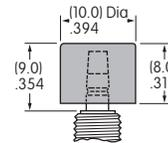

Material: Polycarbonate

Finish: Glossy

Cap Colors Available:

- A** Black
- B** White
- C** Red
- E** Yellow
- F** Green
- G** Blue

## TYPICAL SWITCH DIMENSIONS

Solder Lug

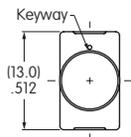

Single Pole

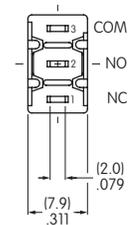
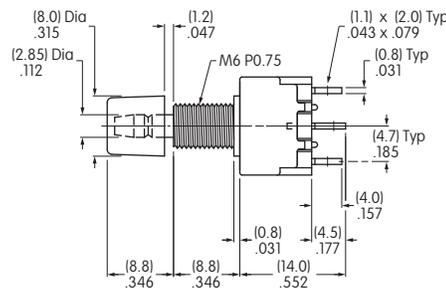

MB2511S4W01-BC

Solder Lug

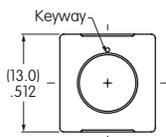

Double Pole

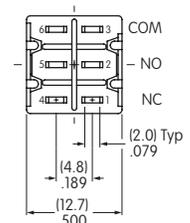
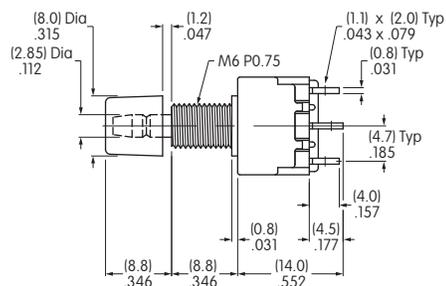

MB2521S4W01-BC

TYPICAL SWITCH ORDERING EXAMPLE

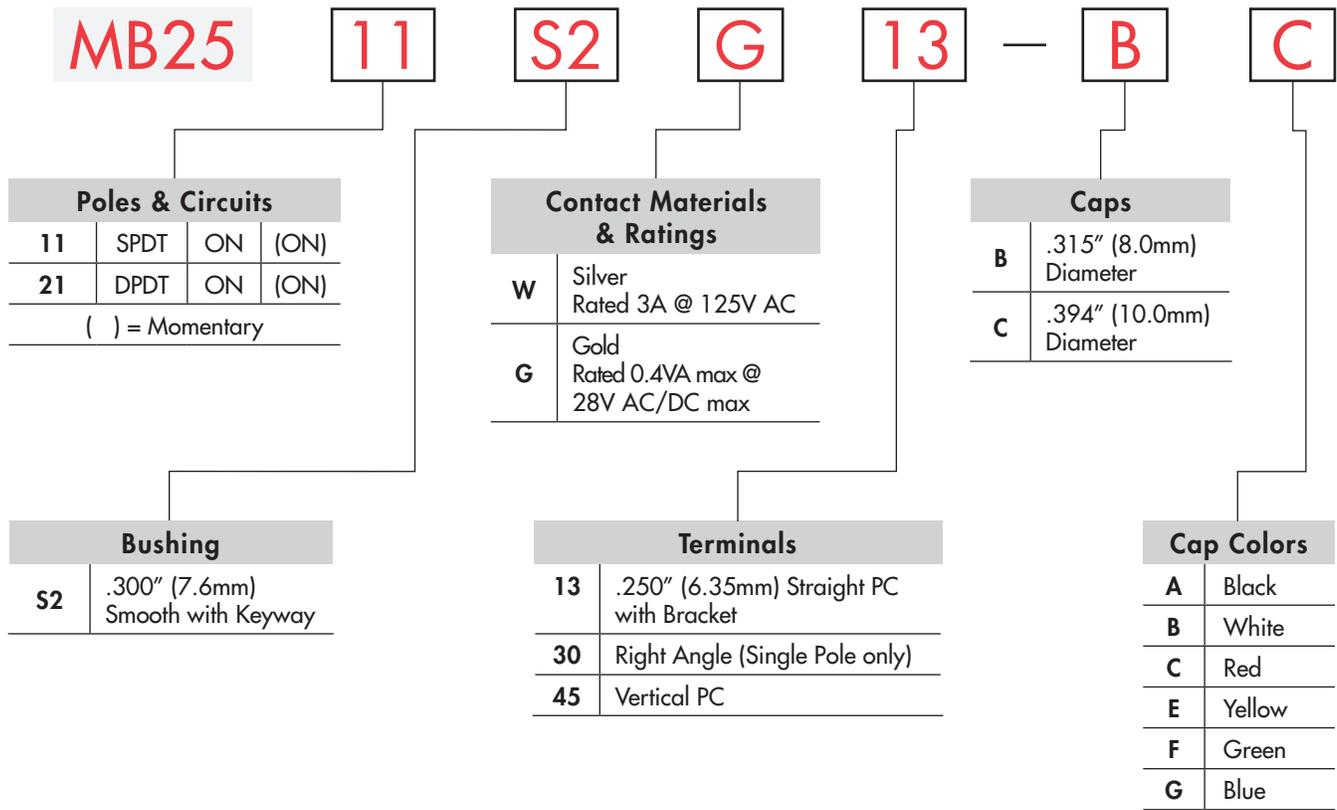

**IMPORTANT:**

Switches are supplied without UL, cULus & CSA marking unless specified. **UL, cULus & CSA recognized only when ordered with marking on the switch.** Specific models, ratings, & ordering instructions are noted on the General Specifications page.

DESCRIPTION FOR TYPICAL ORDERING EXAMPLE

**MB2511S2G13-BC**

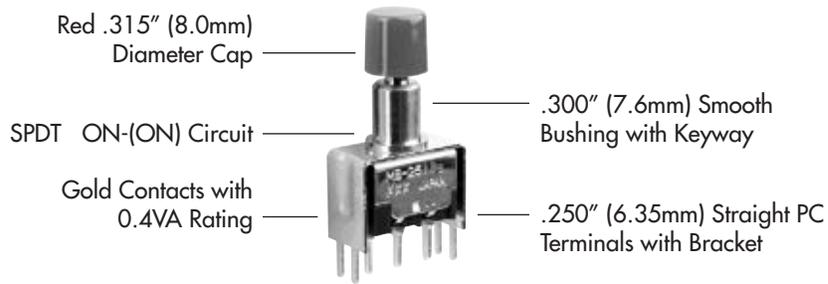

Toggles

Rockers

Pushbuttons

Illuminated PB

Programmable

Keylocks

Rotaries

Slides

Tactiles

Tilt

Touch

Indicators

Accessories

Supplement

### POLES & CIRCUITS

Pole	Model	Plunger Position ( ) = Momentary		Connected Terminals		Throw & Switch Schematics
		Normal	Down	Normal	Down	
						Note: Terminal numbers are not actually on the switch.
SP	MB2511	ON	(ON)	3-1	3-2	SPDT
DP	MB2521	ON	(ON)	3-1 6-4	3-2 6-5	DPDT

### BUSHING

**S2** .300" (7.6mm)  
Smooth with Keyway

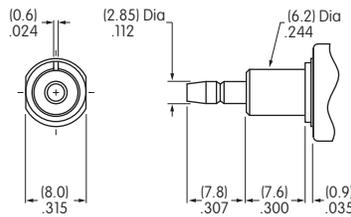

#### Panel Cutout

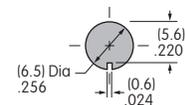

### CONTACT MATERIALS & RATINGS

**W** Silver over Silver

Power Level

3A @ 125V AC

**G** Gold over Brass or Copper

Logic Level

0.4VA maximum @ 28V AC/DC maximum

Note: Complete explanation of operating range in Supplement section.

### TERMINALS

**13** .250" (6.35mm) Terminal  
with .465" (11.8mm) Bracket

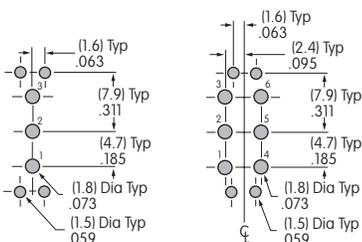
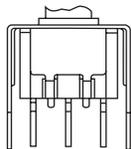

**30** Right Angle PC  
Single Pole only

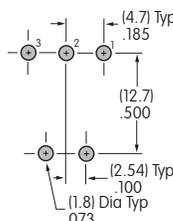
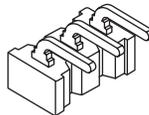

**45** Vertical PC

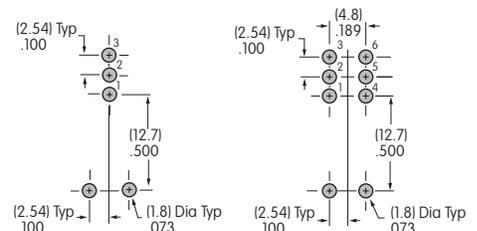
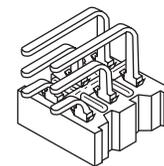

## CAPS & CAP COLORS

**B** AT443  
.315" (8.0mm) Diameter Cap



Material: Polycarbonate

Finish: Glossy

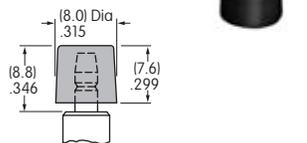

**C** AT442  
.394" (10.0mm) Diameter Cap



Material: Polycarbonate

Finish: Glossy

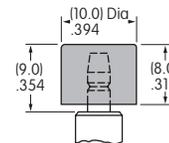

Cap Colors Available:



Black



White



Red



Yellow



Green



Blue

## TYPICAL SWITCH DIMENSIONS

Single Pole

Double Pole

Straight PC • Bracket

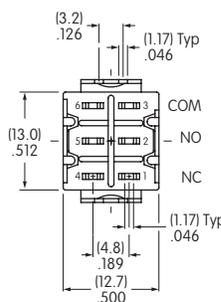
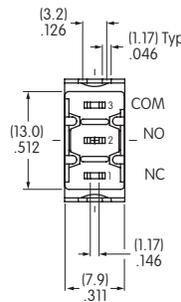
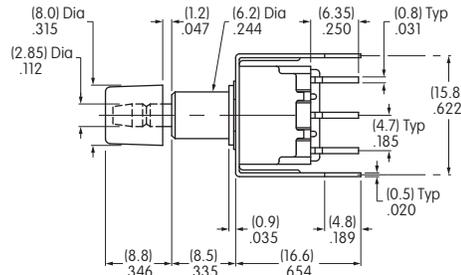
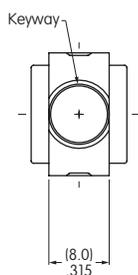

MB2511S2G13-BC

Single Pole

Right Angle PC

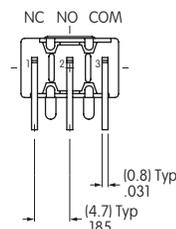
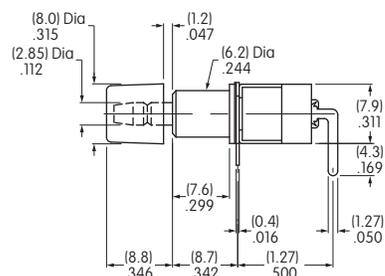
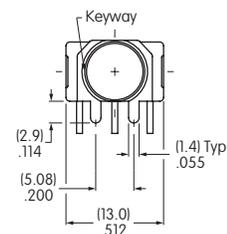

MB2511S2G30-BC

Single Pole

Double Pole

Vertical PC

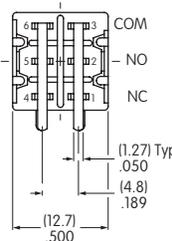
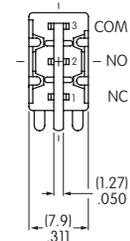
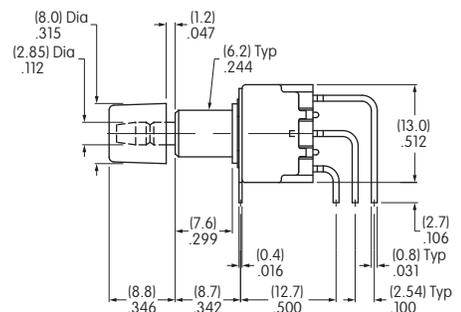
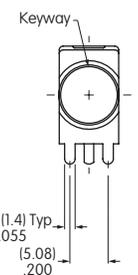

MB2511S2G45-BC

Toggles  
Rockers  
Pushbuttons  
Illuminated PB  
Programmable  
Keylocks  
Rotaries  
Slides  
Tactiles  
Tilt  
Touch  
Indicators  
Accessories  
Supplement

### TYPICAL SWITCH ORDERING EXAMPLE

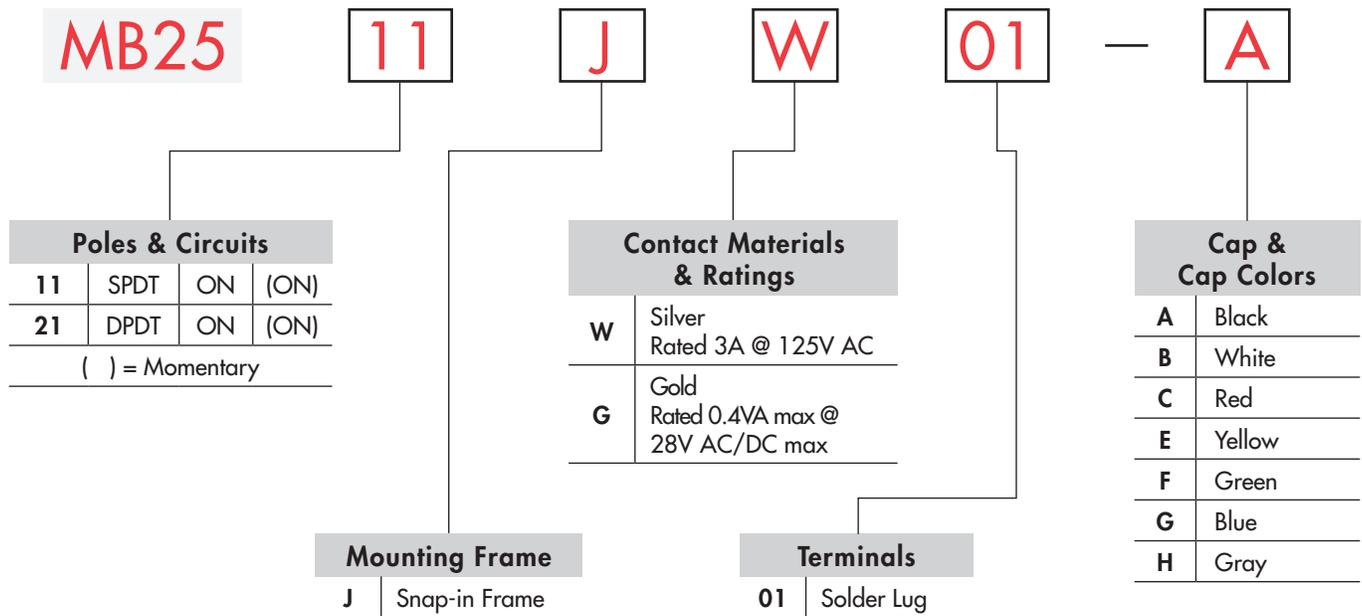

#### IMPORTANT:



Switches are supplied without UL, cULus & CSA marking unless specified. **UL, cULus & CSA recognized only when ordered with marking on the switch.** Specific models, ratings, & ordering instructions are noted on the General Specifications page.

#### DESCRIPTION FOR TYPICAL ORDERING EXAMPLE

**MB2511JW01-A**

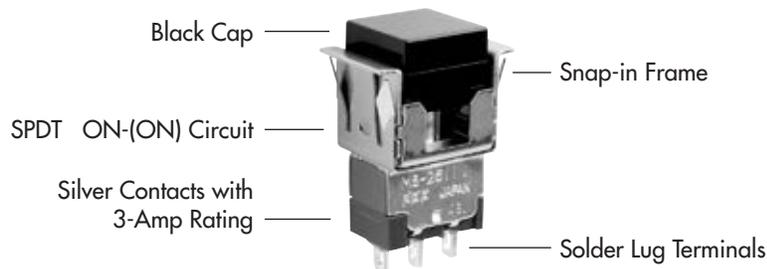

## POLES & CIRCUITS

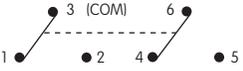
Pole	Model	Plunger Position ( ) = Momentary		Connected Terminals		Throw & Switch Schematics
		Normal	Down	Normal	Down	
SP	MB2511	ON 	(ON) 	3-1 	3-2 	Note: Terminal numbers are not actually on the switch. SPDT 
DP	MB2521	ON 	(ON) 	3-1 6-4 	3-2 6-5 	DPDT 

## MOUNTING FRAME

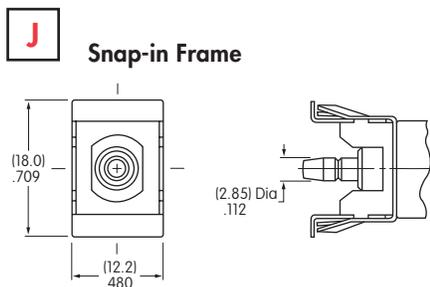

Panel Cutout for Single Pole without Bezel

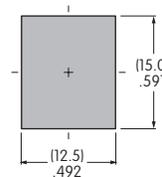

Panel Cutout for Double Pole without Bezel

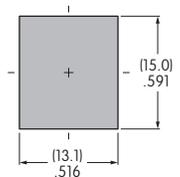

Panel Thickness without Bezel: .039" ~ .157" (1.0mm ~ 4.0mm)  
Panel Thickness with Bezel: .039" ~ .126" (1.0mm ~ 3.2mm)

## CONTACT MATERIALS & RATINGS

<b>W</b>	Silver over Silver	Power Level	3A @ 125V AC
<b>G</b>	Gold over Brass or Copper	Logic Level	0.4VA maximum @ 28V AC/DC maximum

Note: Complete explanation of operating range in Supplement section.

## TERMINALS

**01** Solder Lug

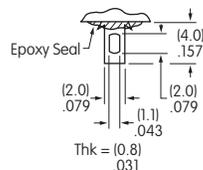

## CAP & CAP COLORS

AT465  
.453" (11.5mm) Square Cap

Material: Polycarbonate  
Finish: Glossy

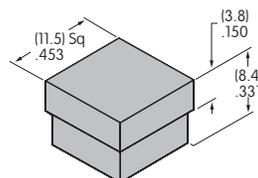

Contact factory for matte finish.

Cap Colors Available: **A** Black **B** White **C** Red **E** Yellow **F** Green **G** Blue **H** Gray

Toggles  
Rockers  
Pushbuttons  
Illuminated PB  
Programmable  
Keylocks  
Rotaries  
Slides  
Tactiles  
Tilt  
Touch  
Indicators  
Accessories  
Supplement

## TYPICAL SWITCH DIMENSIONS

### Solder Lug



**MB2511JW01-A**

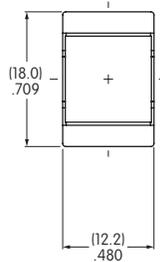

### Single Pole

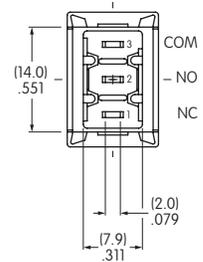
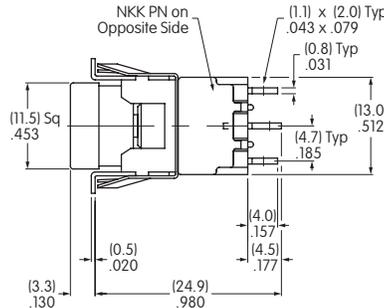

### Solder Lug



**MB2521JW01-C**

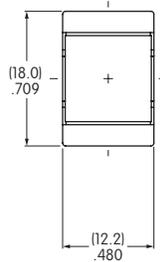

### Double Pole

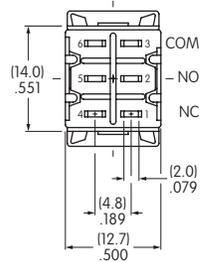
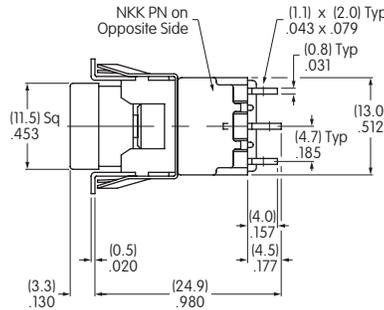

## OPTIONAL SNAP-IN BEZELS & BEZEL COLORS

### AT207 Bezel

Material: Polycarbonate  
Finish: Glossy

Colors:  
Black, White, Red, Yellow,  
Green, Blue, Gray

Contact factory for matte finish.

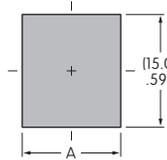
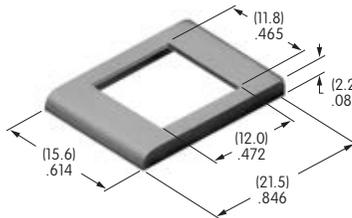

	Single Pole	Double Pole
A	(12.5mm) .492"	(13.1mm) .516"

### AT208 Bezel for AT070 LED

Material: Polycarbonate  
Finish: Glossy

Color: Black

Contact factory for matte finish.

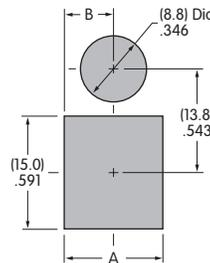
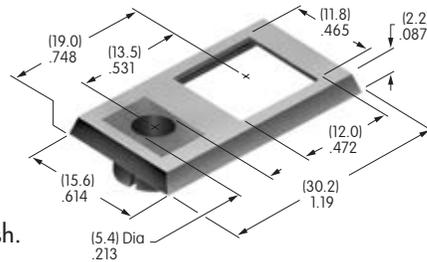

	Single Pole	Double Pole
A	(12.5mm) .492"	(13.1mm) .516"
B	(6.25mm) .246"	(6.55mm) .258"

### AT212 Bezel for AT617 LED

Material: Polycarbonate  
Finish: Semi-glossy

Color: Black

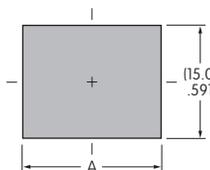
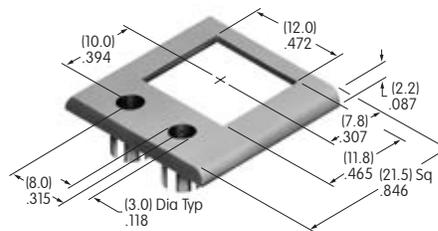

	Single Pole	Double Pole
A	(18.4mm) .724"	(18.7mm) .736"

## OPTIONAL SNAP-IN BEZELS & BEZEL COLORS

### AT213 Bezel for AT618 LED

Material:  
Polycarbonate  
Finish:  
Semi-glossy

Color:  
Black

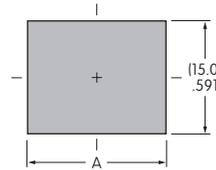
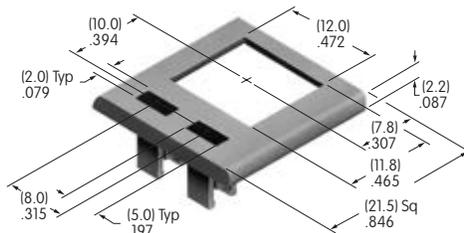

	Single Pole	Double Pole
A	(18.4mm) .724"	(18.7mm) .736"

### Bezel Assembly

1. Pry out tab on bezel to a 45° angle.

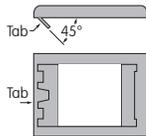

2. Insert switch frame under tab and snap on the bezel.

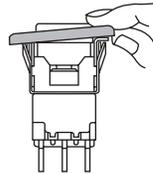

3. Push tab back into place.



4. Snap assembled bezel and switch into panel.

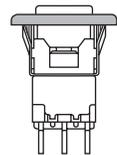

## LED COLORS & SPECIFICATIONS

### Bezel Orientation on Switch

#### AT070 LED For Bezel AT208 with 1 LED

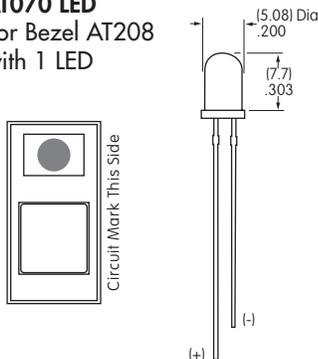

#### AT617 LED For Bezel AT212 with 2 Round LEDs

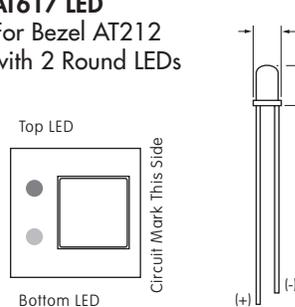

#### AT618 LED For Bezel AT213 with 2 Rectangular LEDs

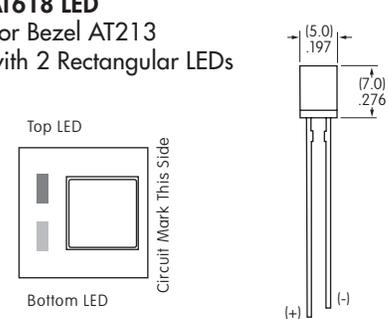

Note: Lead lengths may differ from manufacturing lot to lot. The longer lead is the anode (+).

		AT070		AT617			AT618		
		C	F	C	E	F	C	E	F
Color		Red	Green	Red	Yellow	Green	Red	Yellow	Green
Maximum Forward Current	$I_{FM}$	25mA	50mA	30mA	30mA	30mA	25mA	30mA	25mA
Typical Forward Current	$I_F$	20mA	30mA	20mA	20mA	20mA	20mA	20mA	20mA
Forward Voltage	$V_F$	2.8V	2.1V	2.1V	2.1V	2.2V	2.25V	2.1V	2.2V
Maximum Reverse Voltage	$V_{RM}$	4V	5V	5V	5V	5V	5V	5V	5V
Current Reduction Rate Above 25°C	$\Delta I_F$	0.33 mA/°C	0.40 mA/°C	0.40 mA/°C	0.40 mA/°C	0.40 mA/°C	0.33 mA/°C	0.40 mA/°C	0.33 mA/°C
Ambient Temperature Range (when used with a bezel)		-10° ~ +70°C		-15° ~ +70°C			-25° ~ +70°C		

The electrical specifications shown are determined at a basic temperature of 25°C.  
LED circuit is independent of switch operation. LED is colored in OFF state.

If the source voltage is greater than the rated voltage of the LED, a ballast resistor must be connected in series with the LED.  
The ballast resistor calculation and more lamp detail are shown in the Supplement section.