



# 1.0V Micropower, SOT23, Operational Amplifier

MAX4289

## General Description

The MAX4289 micropower, operational amplifier is optimized for ultra-low supply voltage operation. The amplifier consumes only 9 $\mu$ A of quiescent supply current and is fully specified for operation from a single 1.0V to 5.5V power supply. This ultra-low voltage operation together with the low quiescent current consumption make the MAX4289 ideal for use in battery-powered systems operated from as little as a single alkaline cell. The MAX4289 also features a wide input common-mode range that includes the ground, and an output voltage swing that is virtually Rail-to-Rail<sup>®</sup>, allowing almost all of the power supply to be used for signal voltage.

The low input offset voltage and low input bias current specifications along with the high open-loop gain make the MAX4289 well-suited to applications requiring a high degree of precision.

The MAX4289 is available in a tiny 6-pin SOT23 package. All specifications are guaranteed over the extended temperature range of -40°C to +85°C.

## Applications

Single-Cell Systems	Strain Gauges
Portable Electronic Equipment	Cellular Phones
Battery-Powered Instrumentation	Notebook Computers
Hearing Aids Using Zinc Air Battery	Sensor Amplifiers
	Portable Communication Devices

## Typical Operating Characteristic

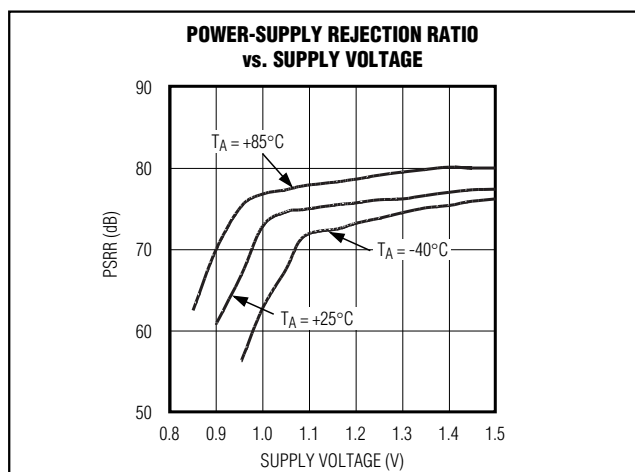

Rail-to-Rail is a registered trademark of Nippon Motorola, Ltd.

## Features

- ◆ Ultra-Low Voltage Operation: Guaranteed Specifications from 1.0V to 5.5V
- ◆ Input Common-Mode Range: 0 to (V<sub>CC</sub> - 0.2V)
- ◆ Ultra-Low Power Consumption: 9 $\mu$ A Supply Current (typ)
- ◆ Optimized for Operation from Single-Cell Battery-Powered Systems
- ◆ Compatible with 3.0V and 5.0V Single-Supply Systems
- ◆ Low Offset Voltage: 0.2mV
- ◆ Low Input Bias Current: 5nA
- ◆ High Open-Loop Voltage Gain: 90dB
- ◆ Rail-to-Rail Output Stage Drives 5k $\Omega$  Load
- ◆ No Output Phase Reversal for Overdriven Inputs
- ◆ Available in a Tiny 6-Pin SOT23 (3mm  $\times$  3mm)

## Ordering Information

PART	TEMP RANGE	PIN-PACKAGE	TOP MARK
MAX4289EUT-T	-40°C to +85°C	6 SOT23-6	AARX
MAX4289ESA	-40°C to +85°C	8 SO	—

## Pin Configurations

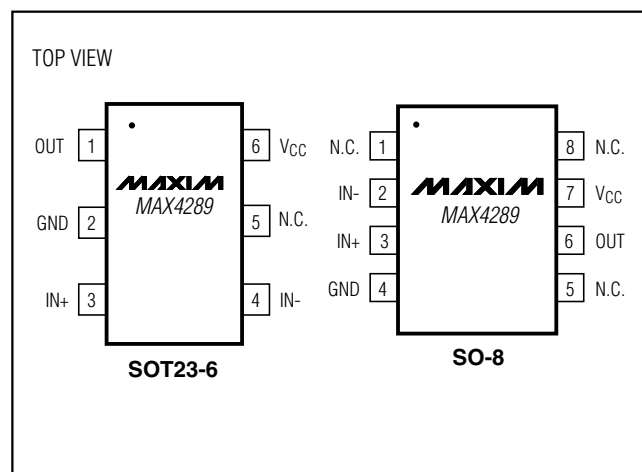

# 1.0V Micropower, SOT23, Operational Amplifier

## ABSOLUTE MAXIMUM RATINGS

Power-Supply Voltage ( $V_{CC}$ to GND).....6V	Operating Temperature Range .....-40°C to +85°C
Input Voltage (IN+ or IN-) .....( $V_{CC} + 0.3V$ ) to -0.3V	Junction Temperature .....+150°C
Input Current (IN+ or IN-).....20mA	Storage Temperature Range .....-65°C to +150°C
Output Short-Circuit Duration to $V_{CC}$ or GND .....Continuous	Lead Temperature (soldering, 10s) .....+300°C
Continuous Power Dissipation ( $T_A = +70^\circ\text{C}$ )	
6-Pin SOT23 (derate 8.7mW/°C above +70°C).....696mW	
8-Pin SO (derate 5.88mW/°C above +70°C).....471mW	

Stresses beyond those listed under "Absolute Maximum Ratings" may cause permanent damage to the device. These are stress ratings only, and functional operation of the device at these or any other conditions beyond those indicated in the operational sections of the specifications is not implied. Exposure to absolute maximum rating conditions for extended periods may affect device reliability.

## ELECTRICAL CHARACTERISTICS

( $V_{CC} = 3V$ ,  $V_{CM} = 0$ ,  $V_{OUT} = V_{CC}/2$ ,  $R_L$  tied to  $V_{CC}/2$ ,  $T_A = T_{MIN}$  to  $T_{MAX}$ , unless otherwise noted. Typical values are at  $T_A = +25^\circ\text{C}$ .) (Note 1)

PARAMETER	SYMBOL	CONDITIONS		MIN	TYP	MAX	UNITS
Supply Voltage Range	$V_{CC}$	Inferred from the PSRR tests	$T_A = +25^\circ\text{C}$	1.0		5.5	V
			$T_A = -40^\circ\text{C}$ to $+85^\circ\text{C}$	1.2		5.5	
Quiescent Supply Current	$I_{CC}$	$V_{CC} = 1.0V$ , $T_A = +25^\circ\text{C}$			9	14	$\mu\text{A}$
		$V_{CC} = 3.0V$			12	25	
		$V_{CC} = 5.5V$			18	40	
Input Offset Voltage	$V_{OS}$	$T_A = +25^\circ\text{C}$			$\pm 0.2$	$\pm 2.0$	mV
		$T_A = T_{MIN}$ to $T_{MAX}$				$\pm 6.0$	
Input Bias Current	$I_B$				$\pm 5$	$\pm 15$	nA
Input Offset Current	$I_{OS}$				$\pm 0.5$	$\pm 2.0$	nA
Differential Input Resistance	$R_{IN}$				50		$M\Omega$
Input Common-Mode Voltage Range	$V_{CM}$	Inferred from CMRR test	$V_{CC} = 1.2V$	0		$V_{CC} - 0.2$	V
			$V_{CC} = 3.0V$	0		$V_{CC} - 0.8$	
Common-Mode Rejection Ratio	CMRR	$V_{CC} = 1.2V$ , $0 \leq V_{CM} \leq V_{CC} - 0.2V$			57		dB
		$V_{CC} = 1.2V$ , $0 \leq V_{CM} \leq V_{CC} - 0.8V$		57	85		
		$V_{CC} = 3.0V$ , $0 \leq V_{CM} \leq V_{CC} - 0.8V$		57	110		
Power-Supply Rejection Ratio	PSRR	$1.0V \leq V_{CC} \leq 5.5V$ , $T_A = +25^\circ\text{C}$		54	75		dB
		$1.2V \leq V_{CC} \leq 5.5V$ , $T_A = -40^\circ\text{C}$ to $+85^\circ\text{C}$		58	75		
Large-Signal Voltage Gain	$A_{VOL}$	$R_L = 100k\Omega$ ( $50mV \leq V_{OUT} \leq V_{CC} - 50mV$ )			110		dB
		$R_L = 5k\Omega$ ( $100mV \leq V_{OUT} \leq V_{CC} - 100mV$ )		80	90		
Output Voltage Swing High	$V_{OH}$	Specified as $ V_{CC} - V_{OH} $	$R_L = 100k\Omega$		0.2	10	mV
			$R_L = 5k\Omega$		7	40	
Output Voltage Swing Low	$V_{OL}$	Specified as $V_{OL}$	$R_L = 100k\Omega$		0.4	10	mV
			$R_L = 5k\Omega$		7	40	

# 1.0V Micropower, SOT23, Operational Amplifier

## ELECTRICAL CHARACTERISTICS (continued)

( $V_{CC} = 3V$ ,  $V_{CM} = 0$ ,  $V_{OUT} = V_{CC}/2$ ,  $R_L$  tied to  $V_{CC}/2$ ,  $T_A = T_{MIN}$  to  $T_{MAX}$ , unless otherwise noted. Typical values are at  $T_A = +25^\circ C$ .) (Note 1)

PARAMETER	SYMBOL	CONDITIONS	MIN	TYP	MAX	UNITS
Output Short-Circuit Current	$I_{OUT}$	Sourcing/sinking current	$V_{CC} = 1.0V$	0.6		mA
			$V_{CC} = 3.0V$	19		
Power-Up Time	$t_{PU}$			300		$\mu s$
Input Capacitance	$C_{IN}$			3.0		pF
Gain-Bandwidth Product	GBW			17		kHz
Phase Margin	$\theta_M$			80		degrees
Gain Margin	GM			10		dB
Slew Rate	SR			6		V/ms
Capacitive-Load Stability		$A_{VCL} = +1V/V$ , no sustained oscillations		200		pF
Settling Time to 0.1%	$t_s$	$A_{VCL} = +1V/V$ , no sustained oscillations		75		$\mu s$

**Note 1:** All specifications are 100% production tested at  $T_A = +25^\circ C$ . Temperature specification limits are guaranteed by design.

## Typical Operating Characteristics

( $V_{CC} = 3V$ ,  $V_{CM} = 0$ ,  $R_L$  to  $V_{CC}/2$ ,  $T_A = +25^\circ C$ , unless otherwise noted.)

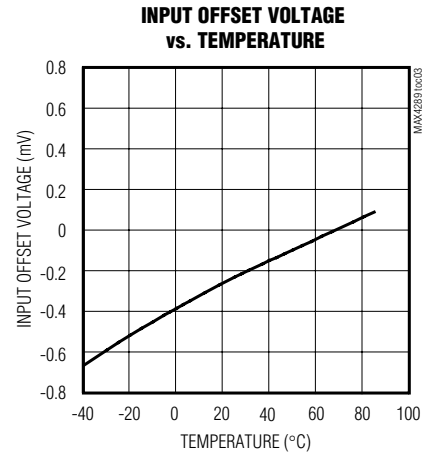
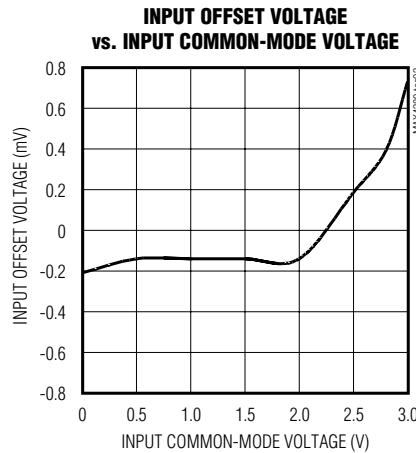
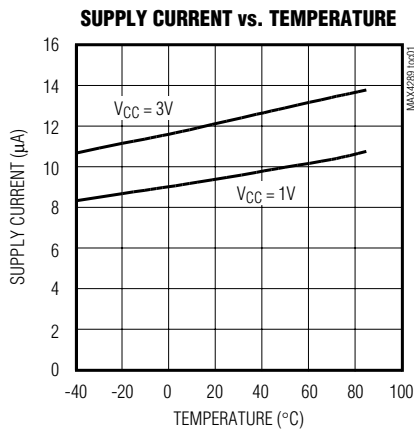

# 1.0V Micropower, SOT23, Operational Amplifier

## Typical Operating Characteristics (continued)

( $V_{CC} = 3V$ ,  $V_{CM} = 0$ ,  $R_L$  to  $V_{CC}/2$ ,  $T_A = +25^\circ C$ , unless otherwise noted.)

**INPUT BIAS CURRENT vs. TEMPERATURE**

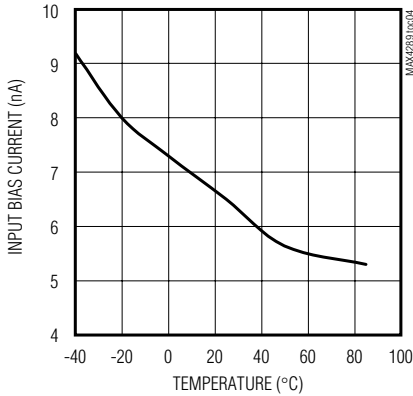

**INPUT BIAS CURRENT vs. INPUT COMMON-MODE VOLTAGE**

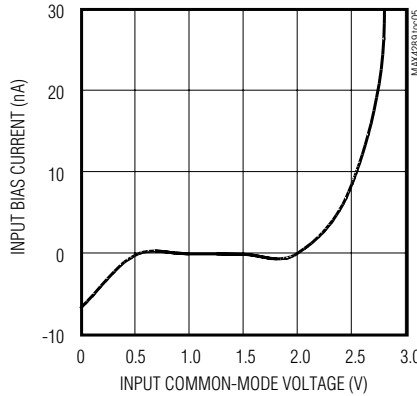

**OUTPUT SWING HIGH vs. TEMPERATURE**

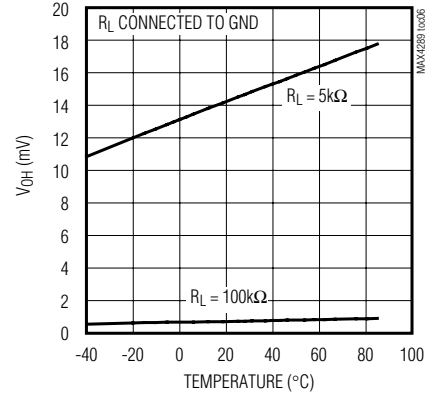

**OUTPUT SWING LOW vs. TEMPERATURE**

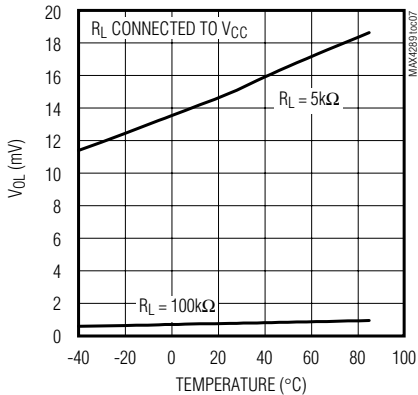

**OPEN-LOOP GAIN vs. OUTPUT SWING LOW**

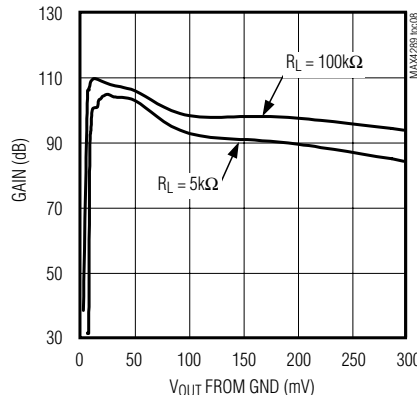

**OPEN-LOOP GAIN vs. OUTPUT SWING HIGH**

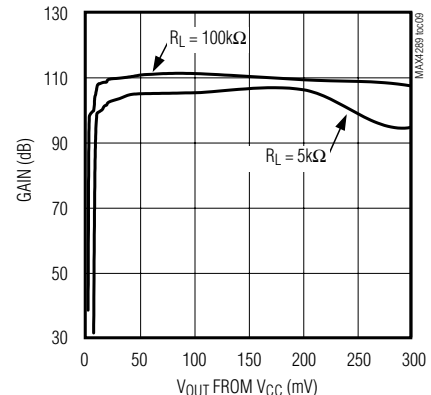

**OPEN-LOOP GAIN vs. TEMPERATURE**

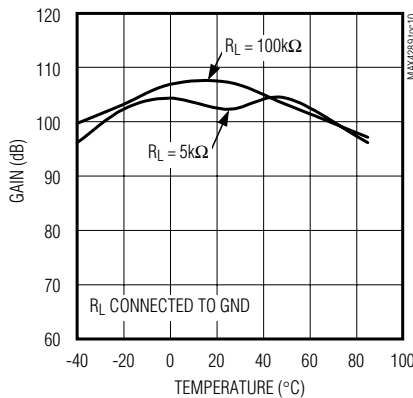

**OPEN-LOOP GAIN vs. TEMPERATURE**

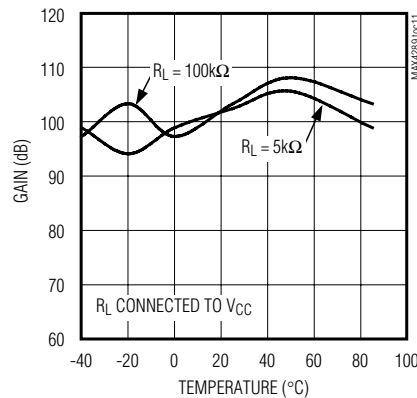

**GAIN AND PHASE vs. FREQUENCY (C\_L = 0)**

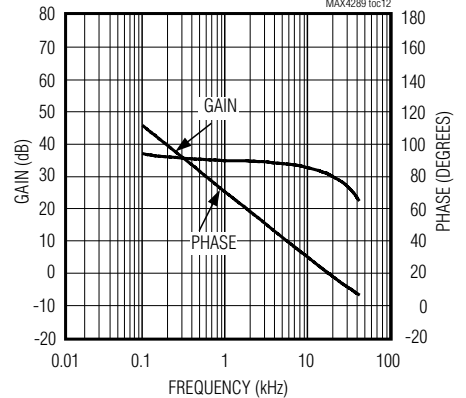

# 1.0V Micropower, SOT23, Operational Amplifier

## Typical Operating Characteristics (continued)

( $V_{CC} = 3V$ ,  $V_{CM} = 0$ ,  $R_L$  to  $V_{CC}/2$ ,  $T_A = +25^\circ C$ , unless otherwise noted.)

**SMALL-SIGNAL TRANSIENT RESPONSE**

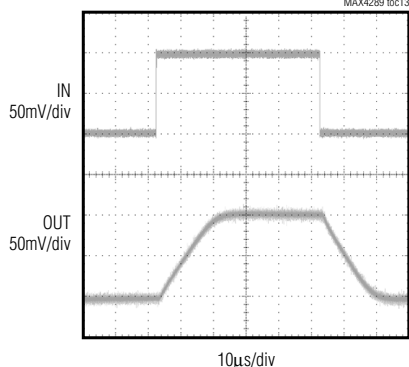

**LARGE-SIGNAL TRANSIENT RESPONSE**

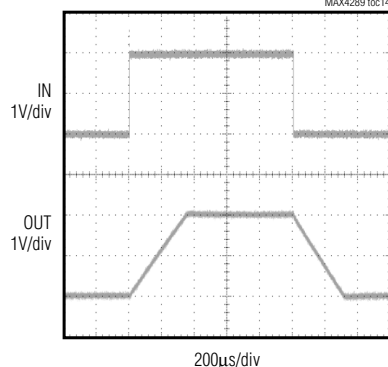

**MINIMUM-OPERATING VOLTAGE vs. TEMPERATURE**

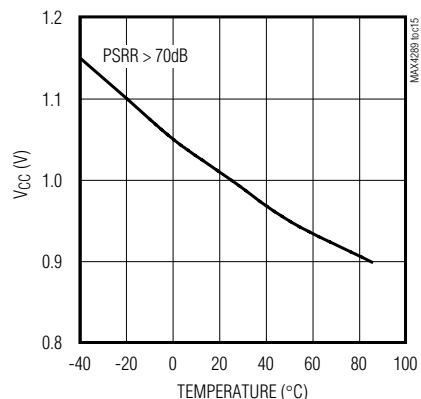

**OUTPUT SINKING CURRENT vs. OUTPUT VOLTAGE**

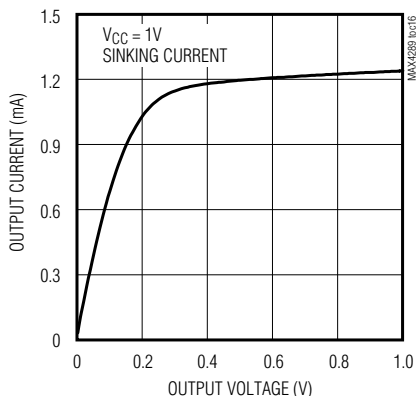

**OUTPUT SINKING CURRENT vs. OUTPUT VOLTAGE**

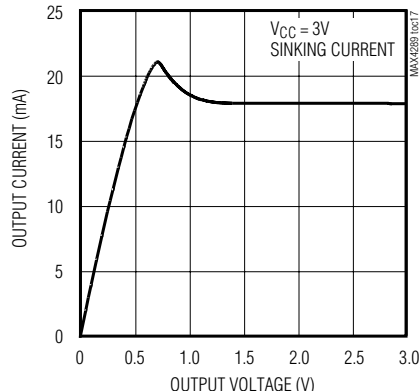

**OUTPUT SOURCING CURRENT vs. OUTPUT VOLTAGE**

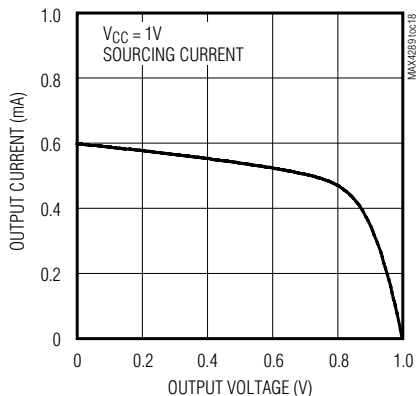

**OUTPUT SOURCING CURRENT vs. OUTPUT VOLTAGE**

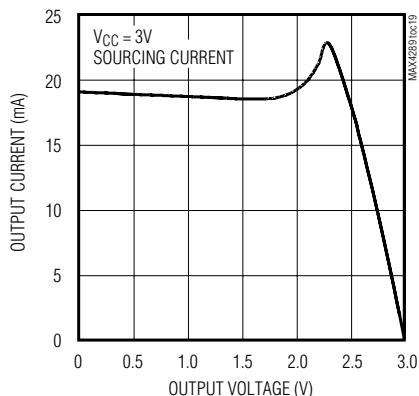

# 1.0V Micropower, SOT23, Operational Amplifier

## Pin Description

PIN		NAME	FUNCTION
SO	SOT23		
1, 5, 8	5	N.C.	No Connection. Not internally connected.
2	4	IN-	Inverting Input
3	3	IN+	Noninverting Input
4	2	GND	Ground
6	1	OUT	Amplifier Output
7	6	V <sub>CC</sub>	Positive Supply. Bypass with a 0.1 $\mu$ F capacitor to GND.

## Detailed Description

The MAX4289 consumes ultra-low power (9 $\mu$ A supply current typically) and has a rail-to-rail output stage that is specifically designed for low-voltage operation. The input common-mode voltage range extends from V<sub>CC</sub> - 0.2V to ground, although full rail-to-rail input range is possible with degraded performance. The input offset voltage is typically 200 $\mu$ V. Low-operating supply voltage, low supply current, and rail-to-rail outputs make this operational amplifier an excellent choice for precision or general-purpose, low-voltage, battery-powered systems.

## Rail-to-Rail Output Stage

The MAX4289 output stage can drive a 5k $\Omega$  load and still swing to within 7mV of the rails. Figure 1 shows the output voltage swing of the MAX4289 configured as a unity-gain buffer, powered from a single 2V supply voltage. The output for this setup typically swings from +0.4mV to (V<sub>CC</sub> - 0.2mV) with a 100k $\Omega$  load.

## Applications Information

### Power-Supply Considerations

The MAX4289 operates from a single 1.0V to 5.5V supply and consumes only 9 $\mu$ A of supply current. A high power-supply rejection ratio of 75dB allows the amplifier to be powered directly off a decaying battery voltage, simplifying design and extending battery life. The MAX4289 is ideally suited for single-cell battery-powered systems. Figures 2 and 3 show the supply current and PSRR as a function of supply voltage and temperature.

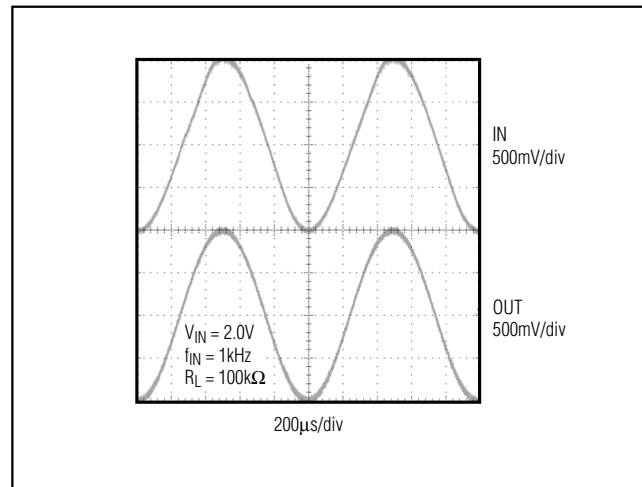

Figure 1. Rail-to-Rail Input/Output Voltage Range

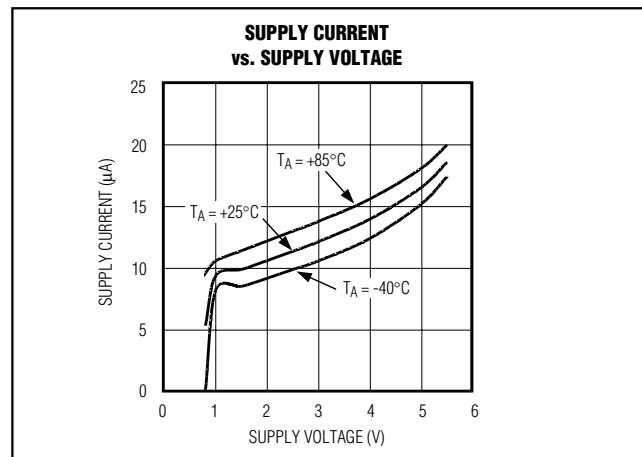

Figure 2. I<sub>CC</sub> vs. V<sub>CC</sub> Over the Temperature Range

# 1.0V Micropower, SOT23, Operational Amplifier

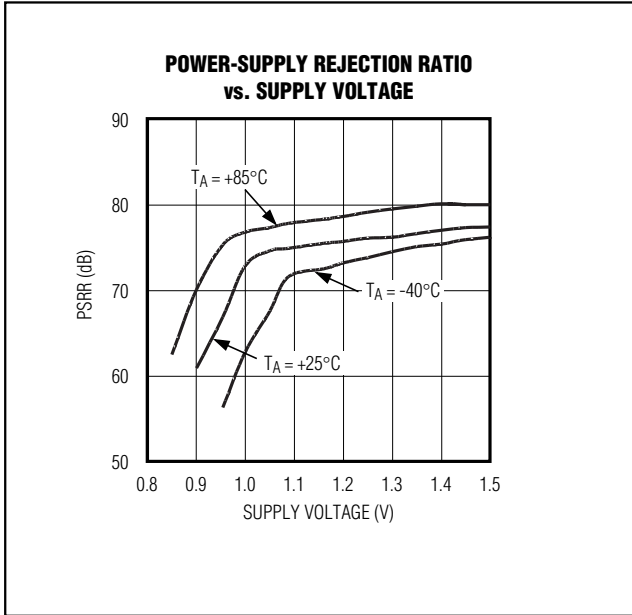

Figure 3. PSRR vs.  $V_{CC}$  Over the Temperature Range

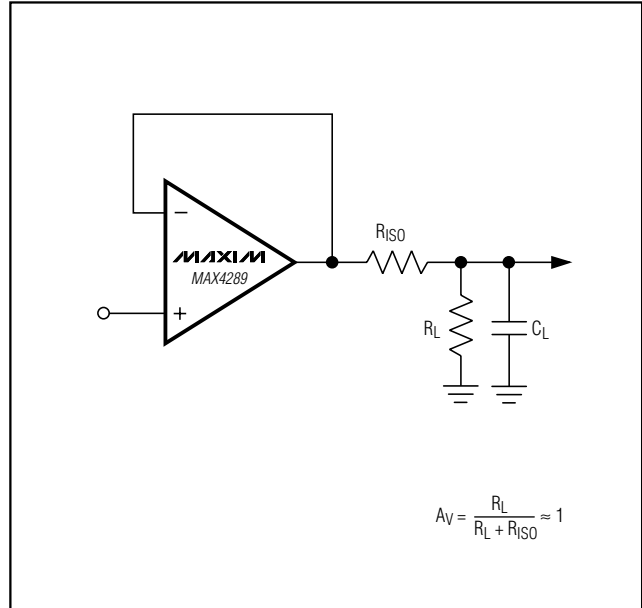

Figure 4. Using a Resistor to Isolate a Capacitive Load from the Op Amp

### Power-Up Settling Time

The MAX4289 typically requires 300 $\mu$ s to power-up after  $V_{CC}$  is stable. During this startup time, the output is indeterminate. The application circuit should allow for this initial delay.

### Driving Capacitive Loads

The MAX4289 is unity-gain stable for loads up to 200pF. Applications that require greater capacitive-drive capability should use an isolation resistor between the output and the capacitive load (Figure 4). Note that this solution results in a loss of gain accuracy because  $R_{ISO}$  forms a voltage-divider with the load resistor.

### Using the MAX4289 as a Comparator

Although optimized for use as an operational amplifier, the MAX4289 can also be used as a rail-to-rail I/O comparator (Figure 5). External hysteresis can be used to minimize the risk of output oscillation. The positive feedback circuit, shown in Figure 5, causes the input threshold to change when the output voltage changes state.

### Power Supplies and Layout

The MAX4289 operates from a single 1V to 5.5V power supply. Bypass the power with a 0.1 $\mu$ F capacitor to ground.

Good layout techniques optimize performance by decreasing the amount of stray capacitance at the op amp's inputs and outputs. To decrease stray capacitance, minimize trace lengths by placing external components close to the op amp's pins.

# 1.0V Micropower, SOT23, Operational Amplifier

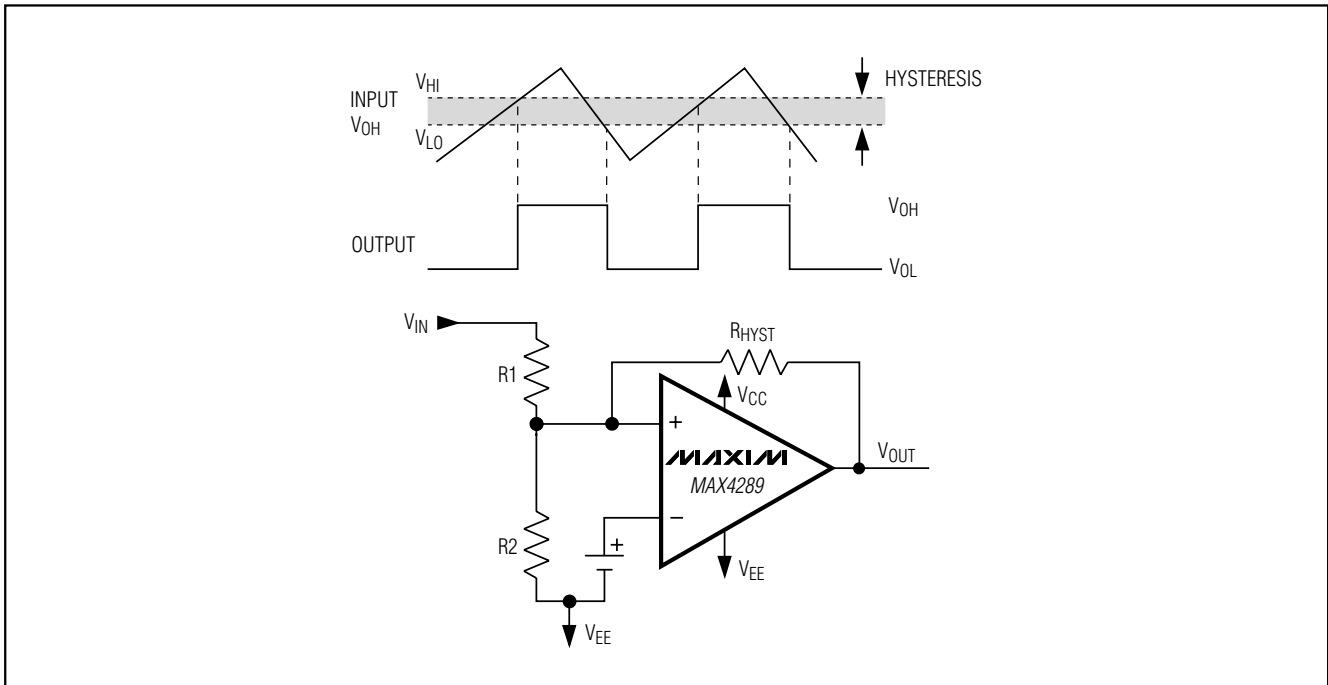

Figure 5. Hysteresis Comparator Circuit

**Chip Information**  
 TRANSISTOR COUNT: 557



# 1.0V Micropower, SOT23, Operational Amplifier

## Package Information

**MAX4289**

SEE NOTE 5  
EXAMPLE  
TOP MARK

PIN 1  
I.D. DOT  
(SEE NOTE 6)

PIN #1

0.20  
DATUM "A"

SYMBOL	MIN	MAX
A	0.90	1.45
A1	0.00	0.15
A2	0.90	1.30
b	0.35	0.50
C	0.08	0.20
D	2.80	3.00
E	2.60	3.00
E1	1.50	1.75
L	0.35	0.55
e	0.95 REF	
α	0°	10°

NOTES:  
 1. ALL DIMENSIONS ARE IN MILLIMETERS.  
 2. FOOT LENGTH MEASURED AT INTERCEPT POINT BETWEEN DATUM A & LEAD SURFACE.  
 3. PACKAGE OUTLINE EXCLUSIVE OF MOLD FLASH & METAL BURR.  
 4. PACKAGE OUTLINE INCLUSIVE OF SOLDER PLATING.  
 5. PIN 1 IS LOWER LEFT PIN WHEN READING TOP MARK FROM LEFT TO RIGHT. (SEE EXAMPLE TOP MARK)  
 6. PIN 1 I.D. DOT IS 0.3 MM Ø MIN. LOCATED ABOVE PIN 1.  
 7. MEETS JEDEC MO17B.

**MAXIM**  
 PROPRIETARY INFORMATION  
 TITLE: PACKAGE OUTLINE, SOT-23, 6L  
 APPROVAL: \_\_\_\_\_ DOCUMENT CONTROL NO: 21-0058 REV E 1/1

**MAXIM**  
 PROPRIETARY INFORMATION  
 TITLE: PACKAGE FAMILY OUTLINE: SOIC .150" 1/1 21-0041 A

INCHES		MILLIMETERS	
MIN	MAX	MIN	MAX
A	0.053	0.069	1.35
A1	0.004	0.010	0.10
B	0.014	0.019	0.35
C	0.007	0.010	0.19
e	0.050		1.27
E	0.150	0.157	3.80
H	0.228	0.244	5.80
h	0.010	0.020	0.25
L	0.016	0.050	0.40

INCHES		MILLIMETERS		N	MS012
MIN	MAX	MIN	MAX		
D	0.189	0.197	4.80	8	A
D	0.337	0.344	8.55	14	B
D	0.386	0.394	9.80	16	C

NOTES:  
 1. D&E DO NOT INCLUDE MOLD FLASH  
 2. MOLD FLASH OR PROTRUSIONS NOT TO EXCEED .15mm (.006")  
 3. LEADS TO BE COPLANAR WITHIN .102mm (.004")  
 4. CONTROLLING DIMENSION MILLIMETER  
 5. MEETS JEDEC MS012-XX AS SHOWN IN ABOVE TABLE  
 6. N = NUMBER OF PINS

Maxim cannot assume responsibility for use of any circuitry other than circuitry entirely embodied in a Maxim product. No circuit patent licenses are implied. Maxim reserves the right to change the circuitry and specifications without notice at any time.

**Maxim Integrated Products, 120 San Gabriel Drive, Sunnyvale, CA 94086 408-737-7600** \_\_\_\_\_ **9**