

Trench gate field-stop 650 V, 30 A high speed HB series IGBT

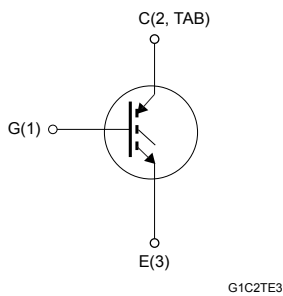
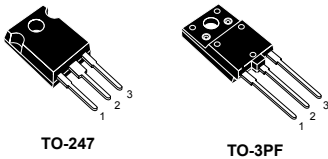

Product status links

[STGFW30H65FB](#)
[STGW30H65FB](#)

Features

- Maximum junction temperature: $T_J = 175\text{ }^\circ\text{C}$
- High speed switching series
- Minimized tail current
- $V_{CE(sat)} = 1.55\text{ V (typ.)}$ at $I_C = 30\text{ A}$
- Tight parameters distribution
- Safe paralleling
- Low thermal resistance

Applications

- Photovoltaic inverters
- Power factor correction
- Welding
- High-frequency converters

Description

These devices are IGBTs developed using an advanced proprietary trench gate field-stop structure. These devices are part of the new HB series of IGBTs, which represent an optimum compromise between conduction and switching loss to maximize the efficiency of any frequency converter. Furthermore, the slightly positive $V_{CE(sat)}$ temperature coefficient and very tight parameter distribution result in safer paralleling operation.

1 Electrical ratings

Table 1. Absolute maximum ratings

Symbol	Parameter	Value		Unit
		TO-247	TO-3PF	
V_{CES}	Collector-emitter voltage ($V_{GE} = 0\text{ V}$)	650		V
I_C	Continuous collector current at $T_C = 25\text{ °C}$	60		A
	Continuous collector current at $T_C = 100\text{ °C}$	30		A
$I_{CP}^{(1)}$	Pulsed collector current	120		A
V_{GE}	Gate-emitter voltage	± 20		V
P_{TOT}	Total power dissipation at $T_C = 25\text{ °C}$	260	92	W
V_{ISO}	Insulation withstand voltage (RMS) from all three leads to external heat sink ($t = 1\text{ s}$; $T_C = 25\text{ °C}$)		3.5	kV
T_{stg}	Storage temperature range	-55 to 150		°C
T_J	Operating junction temperature range	-55 to 175		°C

1. Pulse width is limited by maximum junction temperature.

Table 2. Thermal data

Symbol	Parameter	Value		Unit
		TO-247	TO-3PF	
R_{thJC}	Thermal resistance, junction-to-case	0.58	1.63	°C/W
R_{thJA}	Thermal resistance, junction-to-ambient	50		°C/W

2 Electrical characteristics

$T_J = 25\text{ °C}$ unless otherwise specified

Table 3. Static characteristics

Symbol	Parameter	Test conditions	Min.	Typ.	Max.	Unit
$V_{(BR)CES}$	Collector-emitter breakdown voltage	$V_{GE} = 0\text{ V}$, $I_C = 2\text{ mA}$	650			V
$V_{CE(sat)}$	Collector-emitter saturation voltage	$V_{GE} = 15\text{ V}$, $I_C = 30\text{ A}$		1.55	2	V
		$V_{GE} = 15\text{ V}$, $I_C = 30\text{ A}$, $T_J = 125\text{ °C}$		1.65		
		$V_{GE} = 15\text{ V}$, $I_C = 30\text{ A}$, $T_J = 175\text{ °C}$		1.75		
$V_{GE(th)}$	Gate threshold voltage	$V_{CE} = V_{GE}$, $I_C = 1\text{ mA}$	5	6	7	V
I_{CES}	Collector cut-off current	$V_{GE} = 0\text{ V}$, $V_{CE} = 650\text{ V}$			25	μA
I_{GES}	Gate-emitter leakage current	$V_{CE} = 0\text{ V}$, $V_{GE} = \pm 20\text{ V}$			250	nA

Table 4. Dynamic characteristics

Symbol	Parameter	Test conditions	Min.	Typ.	Max.	Unit
C_{ies}	Input capacitance	$V_{CE} = 25\text{ V}$, $f = 1\text{ MHz}$, $V_{GE} = 0\text{ V}$	-	3659	-	pF
C_{oes}	Output capacitance		-	101	-	pF
C_{res}	Reverse transfer capacitance		-	76	-	pF
Q_g	Total gate charge	$V_{CC} = 520\text{ V}$, $I_C = 30\text{ A}$, $V_{GE} = 0\text{ to }15\text{ V}$ (see Figure 27. Gate charge test circuit)	-	149	-	nC
Q_{ge}	Gate-emitter charge		-	25	-	nC
Q_{gc}	Gate-collector charge		-	62	-	nC

Table 5. Switching characteristics (inductive load)

Symbol	Parameter	Test conditions	Min.	Typ.	Max.	Unit
$t_{d(on)}$	Turn-on delay time	$V_{CE} = 400\text{ V}$, $I_C = 30\text{ A}$, $R_G = 10\ \Omega$, $V_{GE} = 15\text{ V}$ (see Figure 26. Test circuit for inductive load switching)	-	37	-	ns
t_r	Current rise time		-	14.6	-	ns
$(di/dt)_{on}$	Turn-on current slope		-	1643	-	A/ μ s
$t_{d(off)}$	Turn-off delay time		-	146	-	ns
t_f	Current fall time		-	23	-	ns
$E_{on}^{(1)}$	Turn-on switching energy		-	151	-	μ J
$E_{off}^{(2)}$	Turn-off switching energy		-	293	-	μ J
E_{ts}	Total switching energy		-	444	-	μ J
$t_{d(on)}$	Turn-on delay time	$V_{CE} = 400\text{ V}$, $I_C = 30\text{ A}$, $R_G = 10\ \Omega$, $V_{GE} = 15\text{ V}$, $T_J = 175\text{ }^\circ\text{C}$ (see Figure 26. Test circuit for inductive load switching)	-	35	-	ns
t_r	Current rise time		-	16.1	-	ns
$(di/dt)_{on}$	Turn-on current slope		-	1496	-	A/ μ s
$t_{d(off)}$	Turn-off-delay time		-	158	-	ns
t_f	Current fall time		-	65	-	ns
$E_{on}^{(1)}$	Turn-on switching energy		-	175	-	μ J
$E_{off}^{(2)}$	Turn-off switching energy		-	572	-	μ J
E_{ts}	Total switching energy		-	747	-	μ J

1. Including the reverse recovery of the external SiC diode STPSC206W.

2. Including the tail of the collector current.

2.1 Electrical characteristics (curves)

Figure 1. Output characteristics ($T_J = 25^\circ\text{C}$)

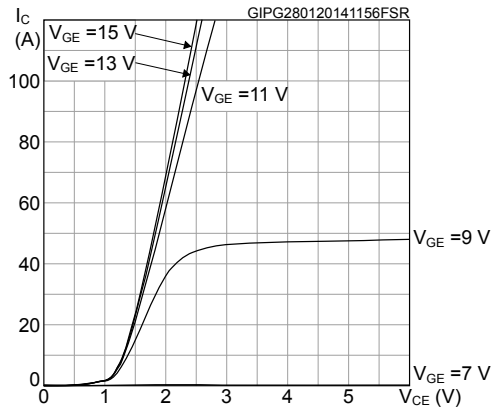

Figure 2. Output characteristics ($T_J = 175^\circ\text{C}$)

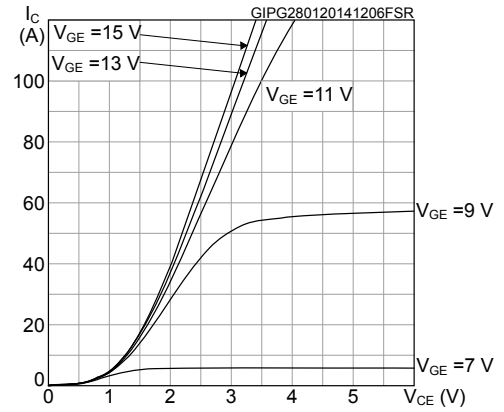

Figure 3. Transfer characteristics

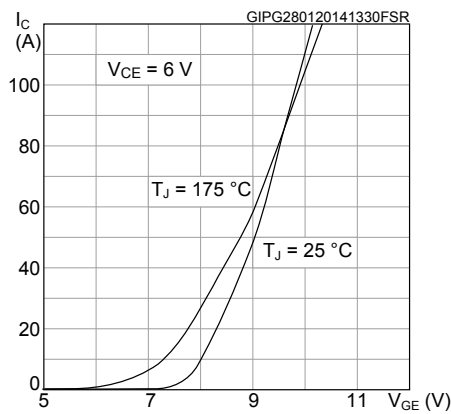

Figure 4. Collector current vs case temperature for TO-247

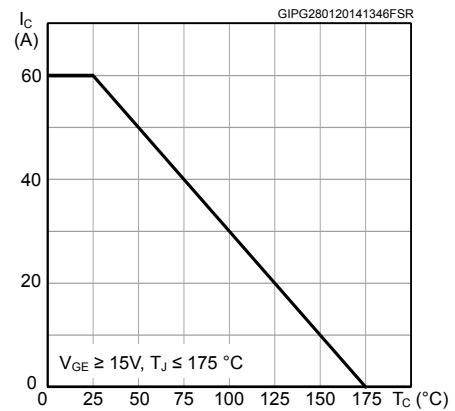

Figure 5. Collector current vs case temperature for TO-3PF

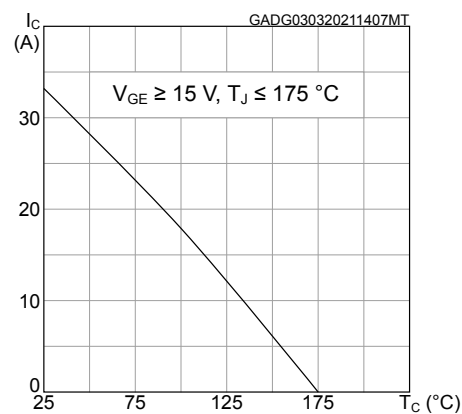

Figure 6. $V_{CE(sat)}$ vs junction temperature

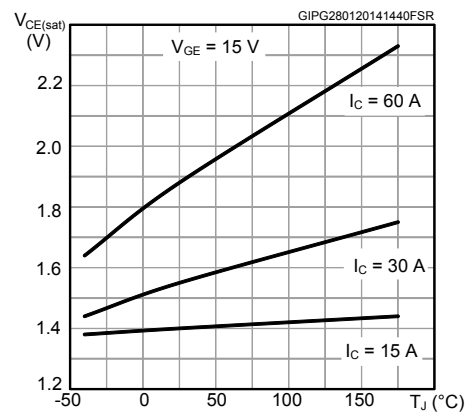

Figure 7. Power dissipation vs case temperature for TO-247

Figure 8. Power dissipation vs case temperature for TO-3PF

Figure 9. Forward bias safe operating area for TO-247

Figure 10. Forward bias safe operating area for TO-3PF

Figure 11. Collector current vs switching frequency for TO-247

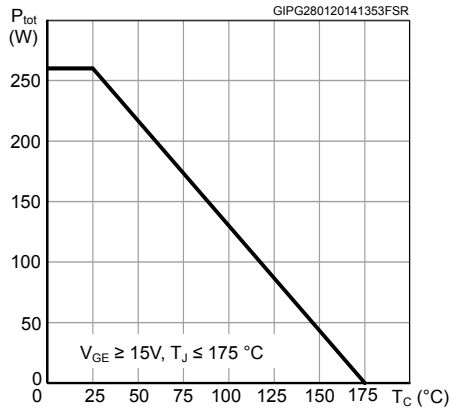
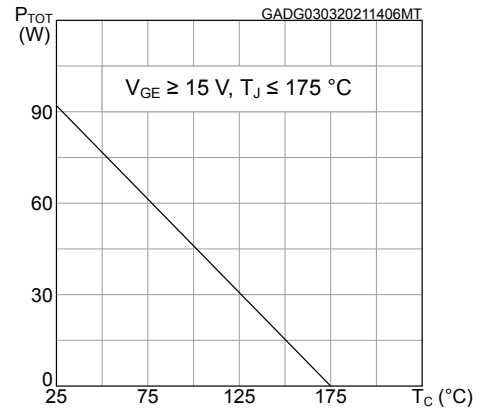
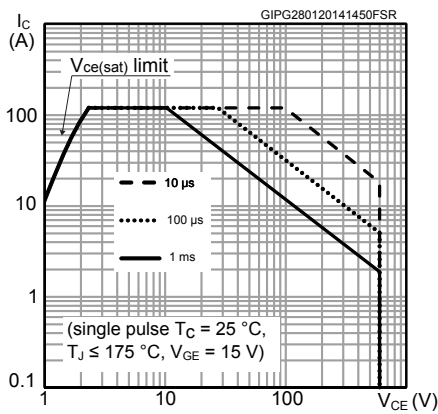
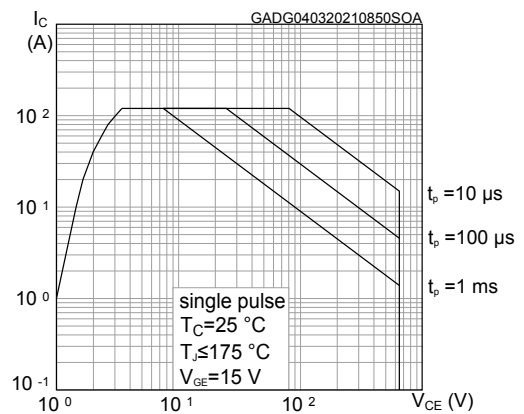
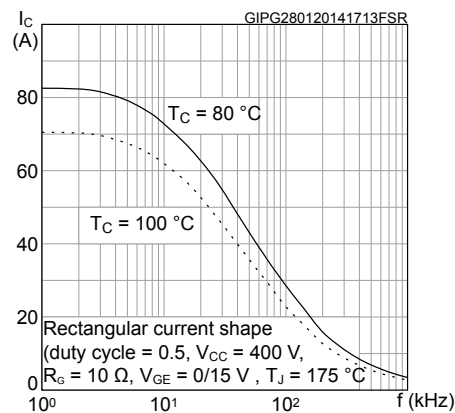
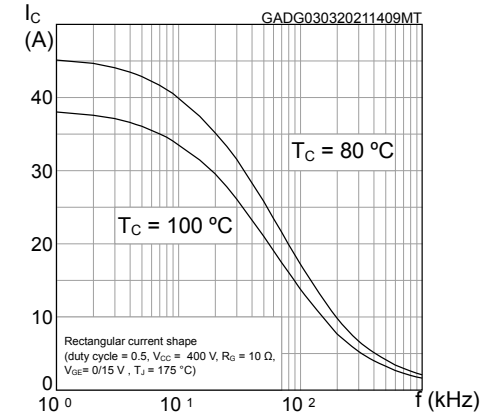
Figure 12. Collector current vs switching frequency for TO-3PF

Figure 13. Normalized $V_{GE(th)}$ vs junction temperature

Figure 14. Normalized $V_{(BR)CES}$ vs junction temperature

Figure 15. Switching energy vs temperature

Figure 16. Switching energy vs gate resistance

Figure 17. Switching energy vs collector current

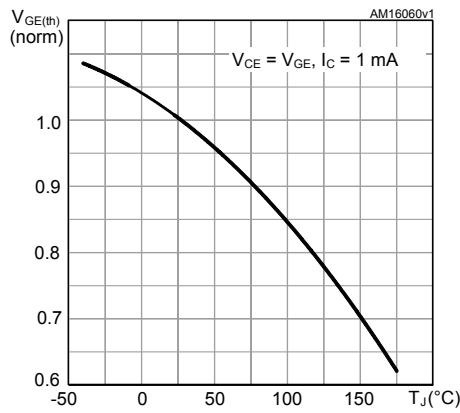
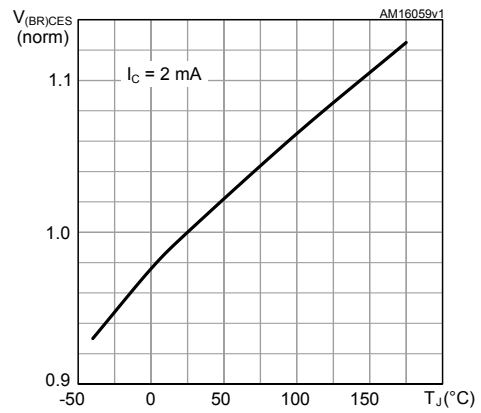
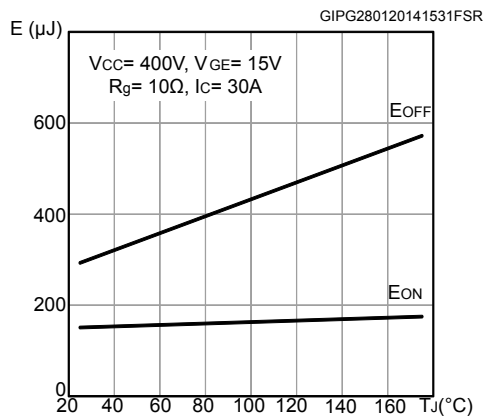
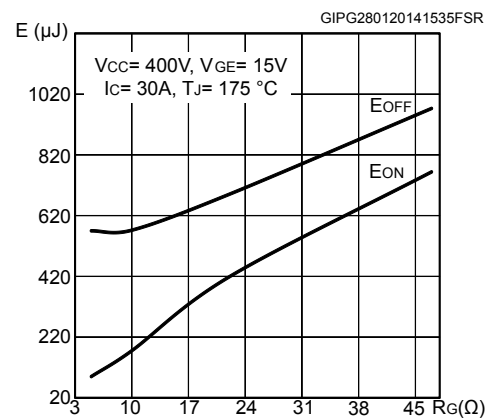
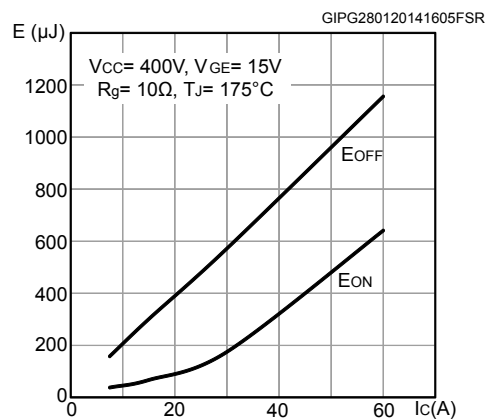
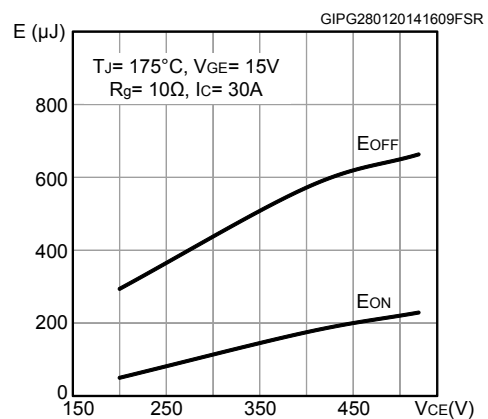
Figure 18. Switching energy vs collector emitter voltage

Figure 19. Switching times vs collector current

Figure 20. Switching times vs gate resistance

Figure 21. Capacitance variations

Figure 22. $V_{CE(sat)}$ vs collector current

Figure 23. Gate charge vs gate-emitter voltage

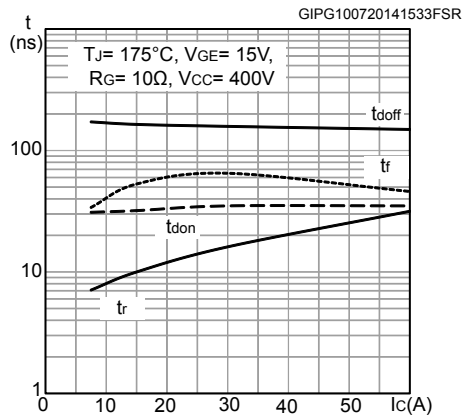
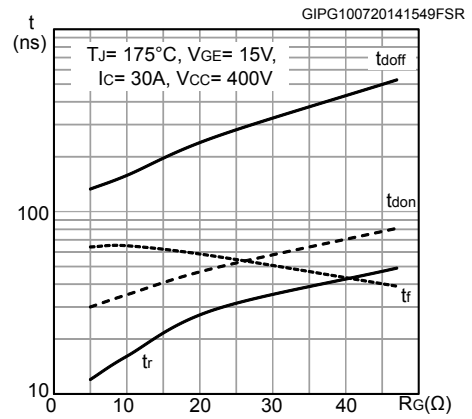
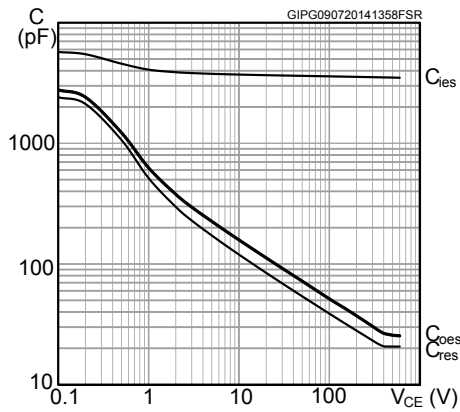
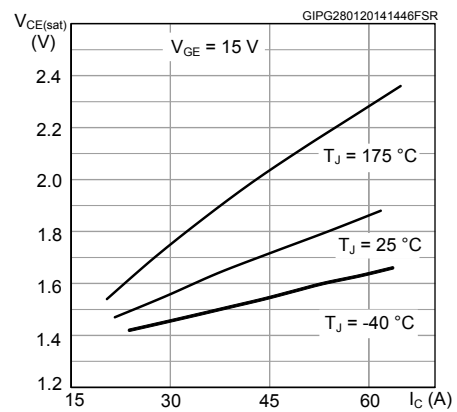
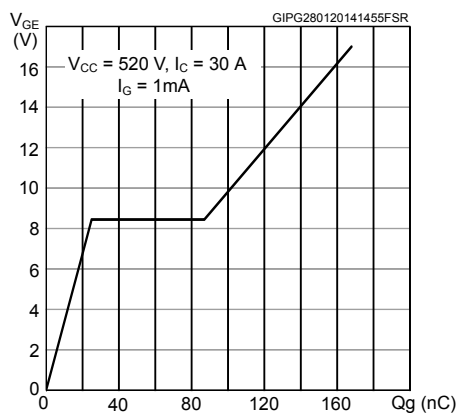
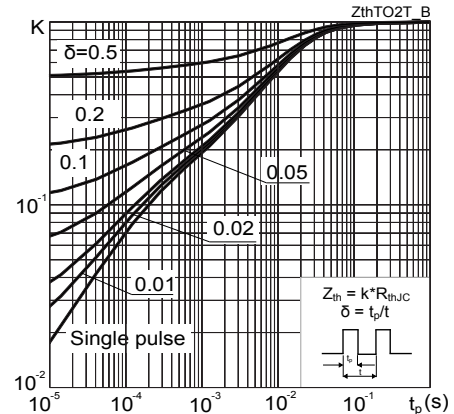
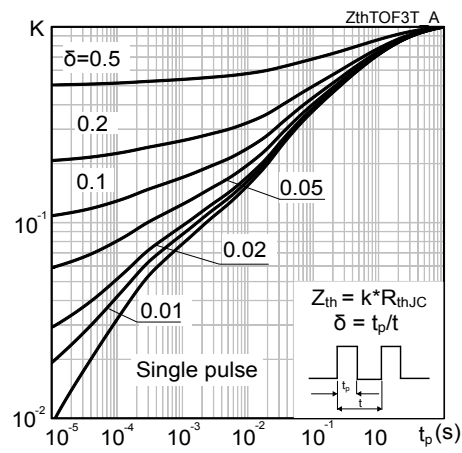
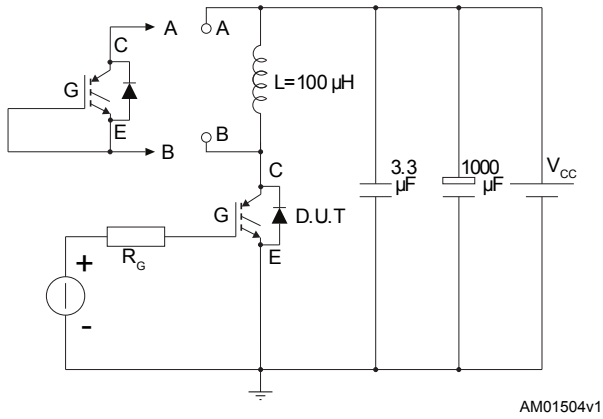
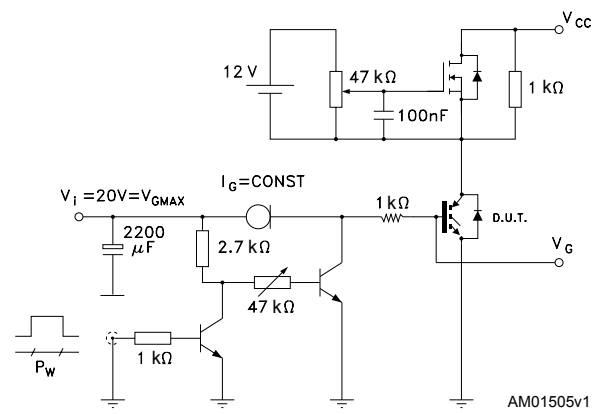
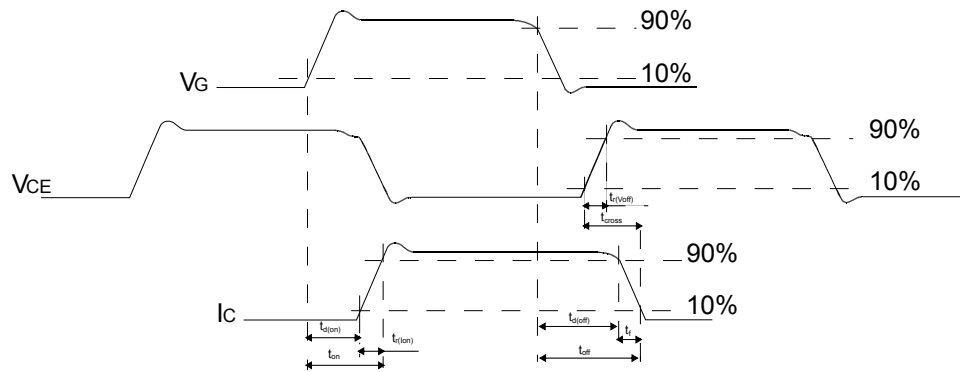
Figure 24. Thermal impedance for TO-247

Figure 25. Thermal impedance for in TO-3PF

3 Test circuits
Figure 26. Test circuit for inductive load switching

Figure 27. Gate charge test circuit

Figure 28. Switching waveform

4 Package information

In order to meet environmental requirements, ST offers these devices in different grades of **ECOPACK** packages, depending on their level of environmental compliance. ECOPACK specifications, grade definitions and product status are available at: www.st.com. ECOPACK is an ST trademark.

4.1 TO-3PF package information

Figure 29. TO-3PF package outline

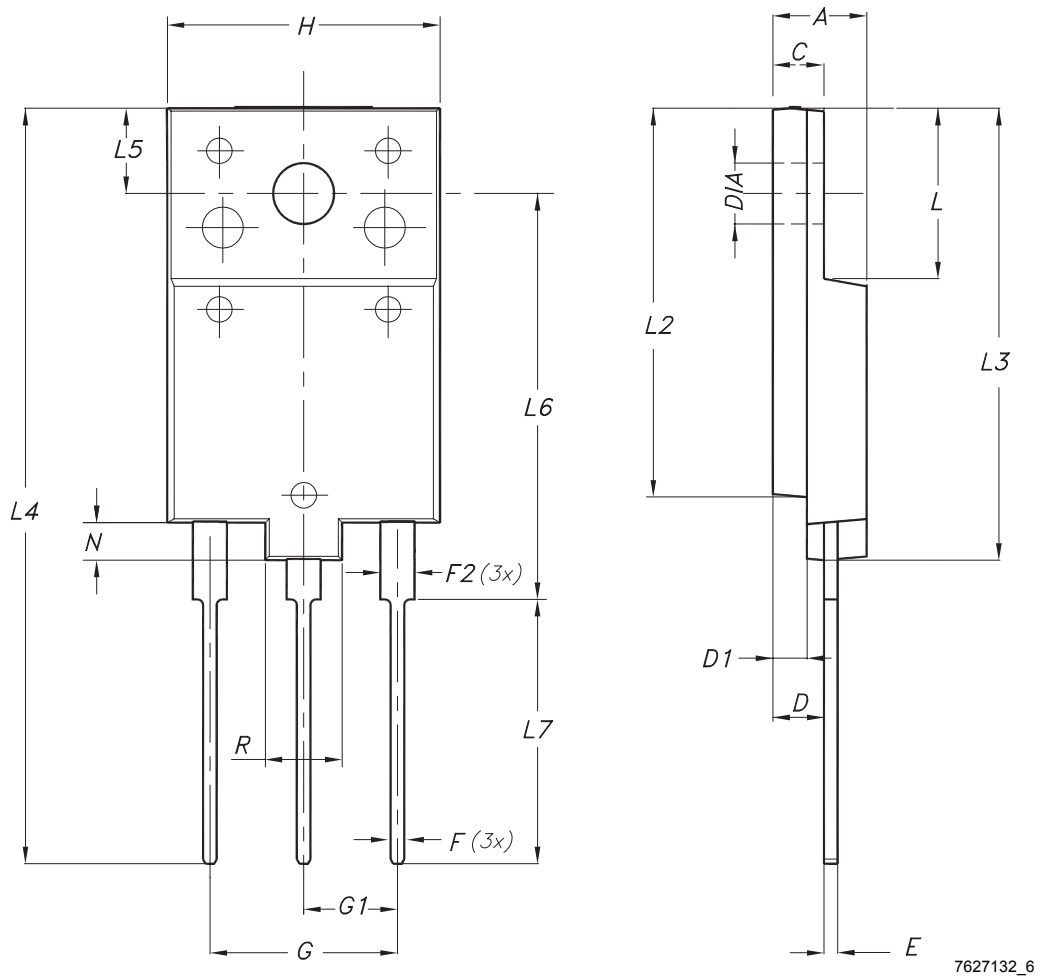
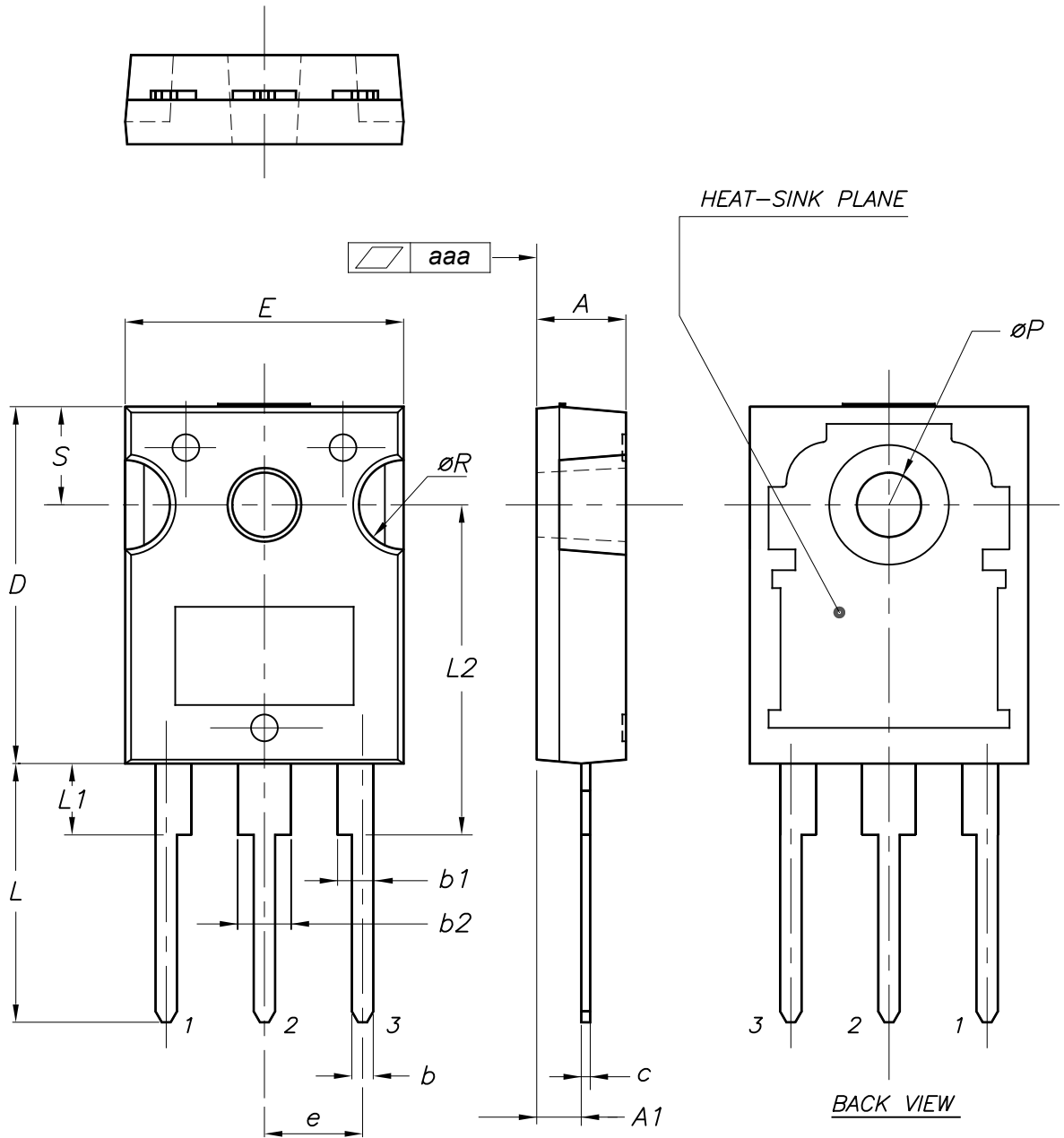

Table 6. TO-3PF mechanical data

Dim.	mm		
	Min.	Typ.	Max.
A	5.30		5.70
C	2.80		3.20
D	3.10		3.50
D1	1.80		2.20
E	0.80		1.10
F	0.65		0.95
F2	1.80		2.20
G	10.30		11.50
G1		5.45	
H	15.30		15.70
L	9.80	10.00	10.20
L2	22.80		23.20
L3	26.30		26.70
L4	43.20		44.40
L5	4.30		4.70
L6	24.30		24.70
L7	14.60		15.00
N	1.80		2.20
R	3.80		4.20
Dia	3.40		3.80

4.2 TO-247 package information

Figure 30. TO-247 package outline



0075325_10

Table 7. TO-247 package mechanical data

Dim.	mm		
	Min.	Typ.	Max.
A	4.85		5.15
A1	2.20		2.60
b	1.0		1.40
b1	2.0		2.40
b2	3.0		3.40
c	0.40		0.80
D	19.85		20.15
E	15.45		15.75
e	5.30	5.45	5.60
L	14.20		14.80
L1	3.70		4.30
L2		18.50	
ØP	3.55		3.65
ØR	4.50		5.50
S	5.30	5.50	5.70
aaa		0.04	0.10

5 Ordering information

Table 8. Order codes

Order code	Marking	Package	Packing
STGFW30H65FB	G30H65FB	TO-3PF	Tube
STGW30H65FB	GW30H65FB	TO-247	

Revision history

Table 9. Document revision history

Date	Revision	Changes
28-Jan-2014	1	Initial release.
24-Feb-2014	2	Updated units in <i>Table 6: Switching characteristics (inductive load)</i> for Ets, and updated note 1. Update <i>Figure 16: Switching losses vs temperature</i> , <i>Figure 17: Switching losses vs gate resistance</i> and <i>Figure 18: Switching losses vs collector current</i> . Updated title and features in cover page. Minor text changes.
10-Mar-2014	3	Added device in TO-3PF. Updated <i>Table 1: Device summary</i> , <i>Table 2: Absolute maximum ratings</i> , <i>Table 3: Thermal data</i> . Added <i>Figure 6: Collector current vs. case temperature for TO-3PF</i> , <i>Figure 9: Power dissipation vs. case temperature for TO-3PF</i> , <i>Figure 11: Forward bias safe operating area for TO-3PF</i> and <i>Figure 26: Thermal impedance for TO-3PF</i> . Updated <i>Section 4: Package information</i> .
20-May-2014	4	Updated <i>Table 2: Absolute maximum ratings</i> .
28-Jul-2015	5	Text and formatting changes throughout document Updated <i>Table 2: Absolute maximum ratings</i> Updated <i>Section 2.1: Electrical characteristics (curves)</i> Updated <i>Section 3: Test circuits</i> Updated <i>Section 4.2: TO-247 package information</i> Updated <i>Section 4.3: TO-3P package information</i>
27-Apr-2020	6	Updated applications in cover page. Updated <i>Table 8. Order codes</i> . Minor text changes.
16-Mar-2021	7	The part number STGWT30H65FB has been removed and the document has been updated accordingly. Updated Section 1 Electrical ratings and Section 2.1 Electrical characteristics (curves) . Minor text changes.

Contents

1	Electrical ratings	2
2	Electrical characteristics	3
2.1	Electrical characteristics (curves)	5
3	Test circuits	10
4	Package information	11
4.1	TO-3PF package information	11
4.2	TO-247 package information	13
5	Ordering information	15
	Revision history	16

IMPORTANT NOTICE – PLEASE READ CAREFULLY

STMicroelectronics NV and its subsidiaries (“ST”) reserve the right to make changes, corrections, enhancements, modifications, and improvements to ST products and/or to this document at any time without notice. Purchasers should obtain the latest relevant information on ST products before placing orders. ST products are sold pursuant to ST’s terms and conditions of sale in place at the time of order acknowledgement.

Purchasers are solely responsible for the choice, selection, and use of ST products and ST assumes no liability for application assistance or the design of Purchasers’ products.

No license, express or implied, to any intellectual property right is granted by ST herein.

Resale of ST products with provisions different from the information set forth herein shall void any warranty granted by ST for such product.

ST and the ST logo are trademarks of ST. For additional information about ST trademarks, please refer to www.st.com/trademarks. All other product or service names are the property of their respective owners.

Information in this document supersedes and replaces information previously supplied in any prior versions of this document.

© 2021 STMicroelectronics – All rights reserved