



ESSENTIAL INFORMATION

BUILD INSTRUCTIONS
CHECKING YOUR PCB & FAULT-FINDING
MECHANICAL DETAILS
HOW THE KIT WORKS

RELAX YOUR WAY TO SLEEP WITH THIS

TIMED NIGHT LIGHT KIT

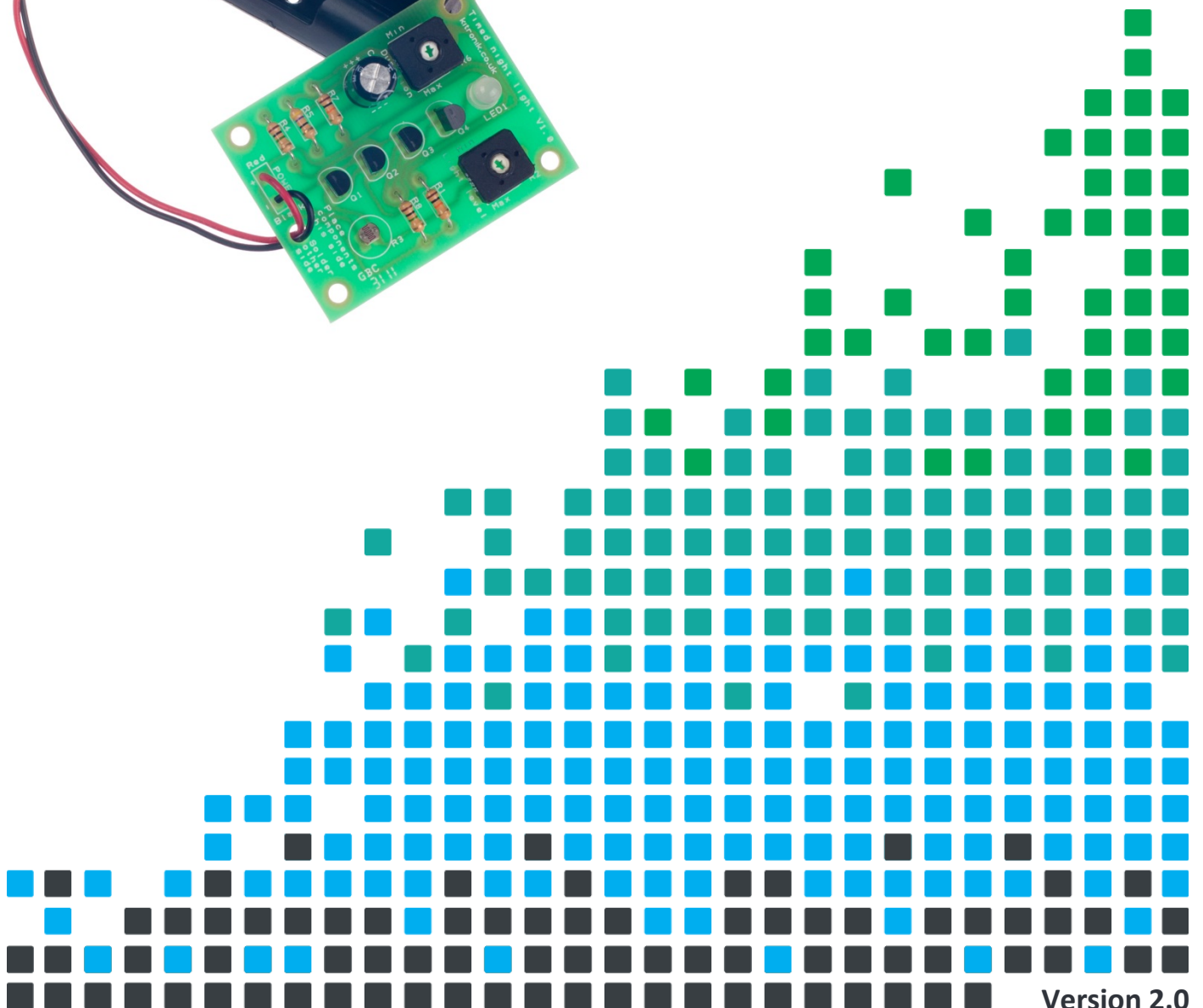
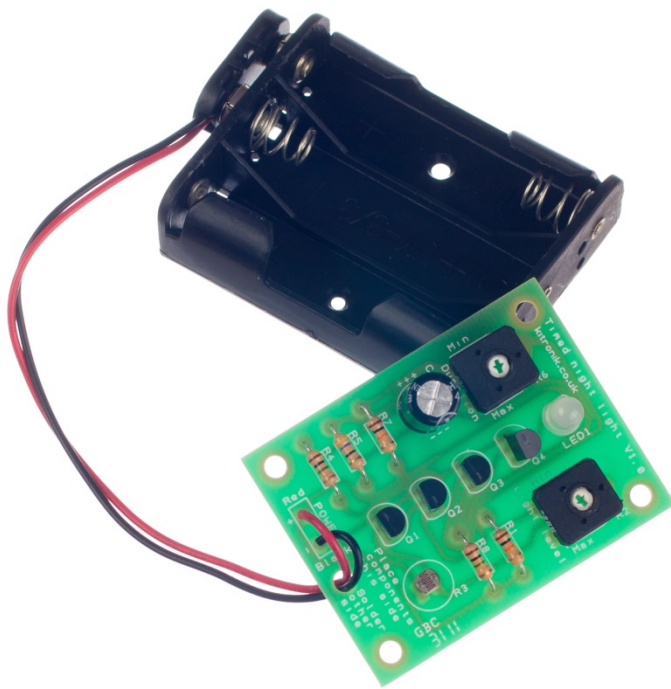

Version 2.0

Build Instructions

Before you start, take a look at the Printed Circuit Board (PCB). The components go in the side with the writing on and the solder goes on the side with the tracks and silver pads.

1 PLACE RESISTORS

Start with the five resistors:
The text on the PCB shows where R1, R2 etc go.
Ensure that you put the resistors in the right place.

PCB Ref	Value	Colour Bands
R1 & R7	10K	Brown, black, orange
R4 & R8	1M	Brown, black, green
R5	47Ω	Yellow, purple, black



2 SOLDER THE LDR

The LDR needs to be soldered into the board where it is marked R3.



3 SOLDER THE VARIABLE RESISTORS

Solder the variable resistors into R2 & R6. They will only fit in the holes in the board when they are the correct way around. The two resistors are different values, R2 is a 220K and R6 is 10M, make sure that you put both in the right place.



4 PLACE THE FETS

The four FETs should be placed into Q1 to Q4. All four are the same type but it is important that they are inserted in the correct orientation. Ensure that the shape of the device matches the outline printed on the PCB. Once you are happy, solder the devices into place.

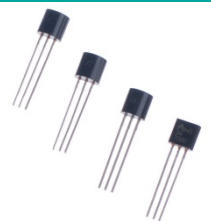

5 SOLDER THE LED

Solder the Light Emitting Diode (LED) into LED1. The LED won't work if it doesn't go in the right way around. If you look carefully one side of the LED has a flat edge, which must line up with the flat edge on the lines on the PCB.



6 SOLDER THE CAPACITOR

Solder the capacitor into the board where it is marked C1. It is important that the '-' on the capacitor matches the '----' markings on the PCB.



7

ATTACH THE BATTERY CONNECTOR

Now you must attach the battery clip. It needs to be connected to the terminals marked 'Power'. The red lead should be soldered to the '+' terminal also marked 'red' and the black lead should be soldered to the '-' terminal also marked 'black'. Connect the PP3 snap on to the 3xAA battery box. Do not use a 9V battery with this circuit.



Checking Your Circuit

Check the following before you connect power to the board:

Check the bottom of the board to ensure that:

- All the leads are soldered.
- Pins next to each other are not soldered together.

Check the top of the board to ensure that:

- The body of the four FETs matches the outline on the PCB.
- The flat edge on the LED lines matches the outline on the PCB.
- The red wire on the power clip goes to the connection marked 'red' and the black wire to the connection marked 'black'.
- R1 & R7 are 10K resistors (brown, black, orange colour bands).
- R5 is a 47 Ω resistor (yellow, purple, black colour bands).
- R2 has 220K printed on the side.

Testing the PCB

Set the duration to min – fully anti-clockwise.

Set the light level so that it points at the other trimmer.

Power the board up and cover the LDR – the LED should turn on for about five seconds. Uncover the LDR, then cover it again, the LED should turn on again for about five seconds. The duration and light level can be adjusted.

If the circuit doesn't function as expected, use the fault finding flow chart to locate the problem.



Timed Night Light Essentials

www.kitronik.co.uk/2139



Fault finding flow chart

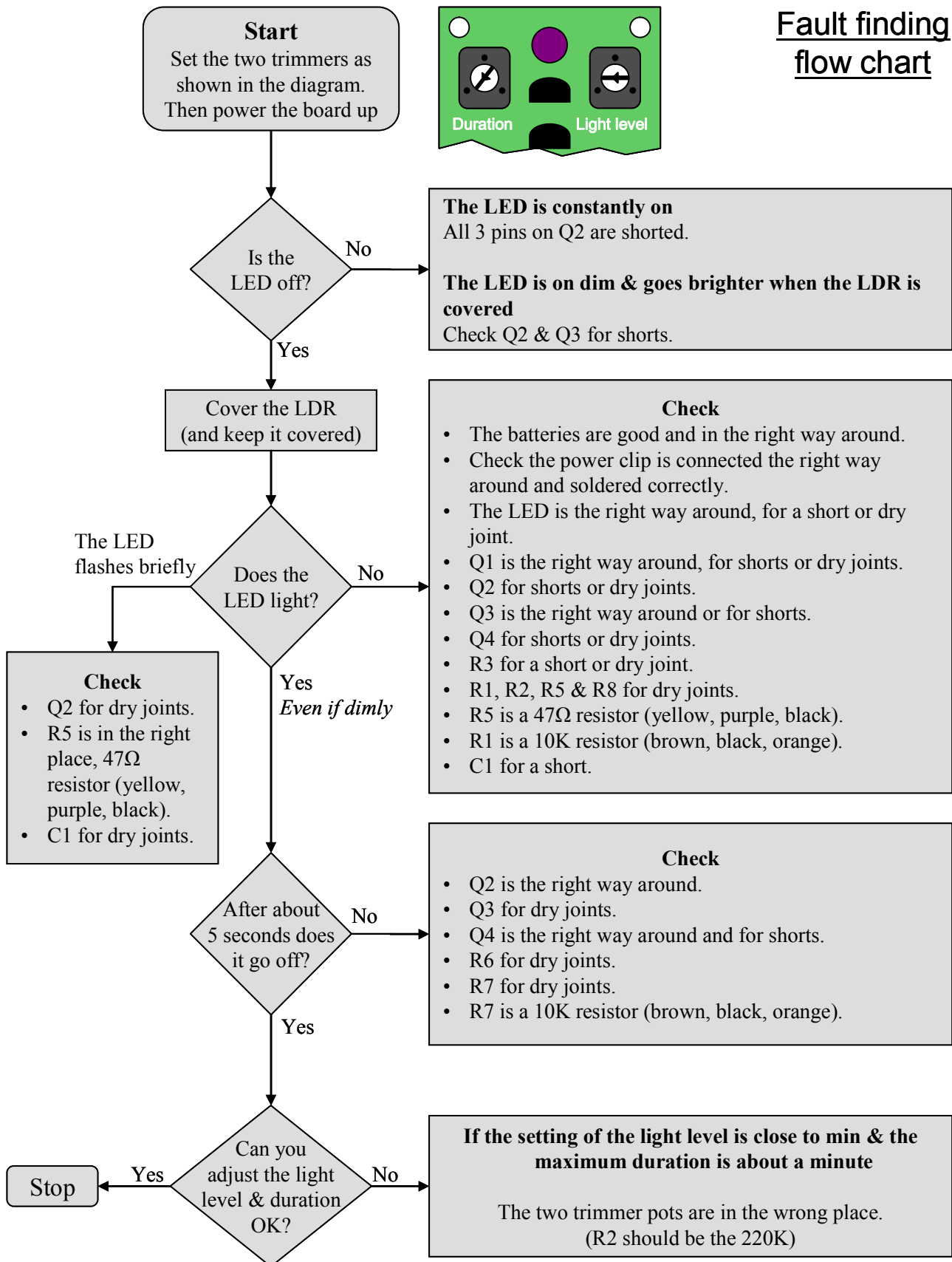
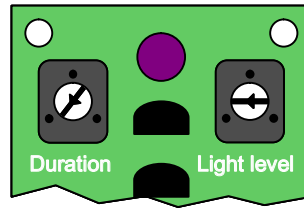

Designing the Enclosure

When you design the enclosure, you will need to consider:

- The size of the PCB (below left).
- How big the batteries are (below right).

These technical drawings of the PCB and battery holder should help you to plan this.

All dimensions in mm.

Four PCB mounting holes are 3.3 mm in diameter.

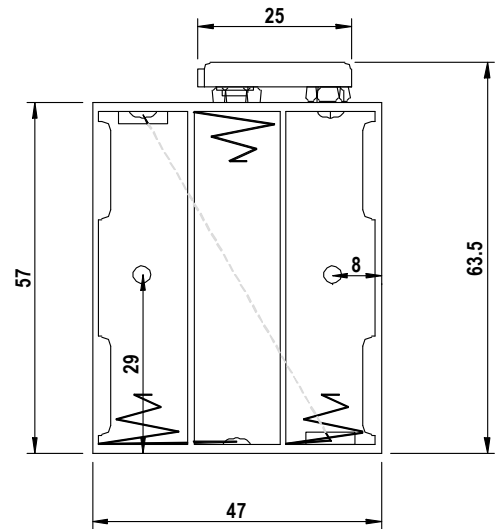
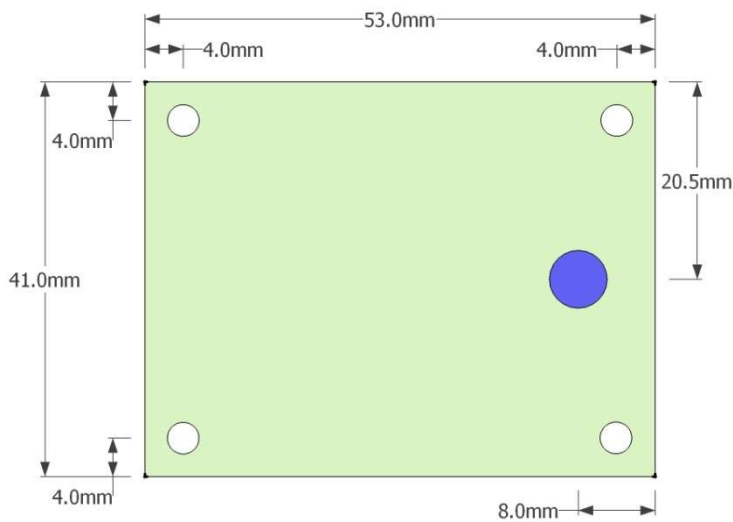

<p>P.C.B</p> <p>SPACER</p> <p>ENCLOSURE</p> <p>2 X M3 BOLTS</p>	<p>Mounting the PCB to the enclosure</p> <p>The drawing to the left shows how a hex spacer can be used with two bolts to fix the PCB to the enclosure.</p> <p><i>Your PCB has four mounting holes designed to take M3 bolts.</i></p>
---	---



How the Timed Night Light Circuit Works

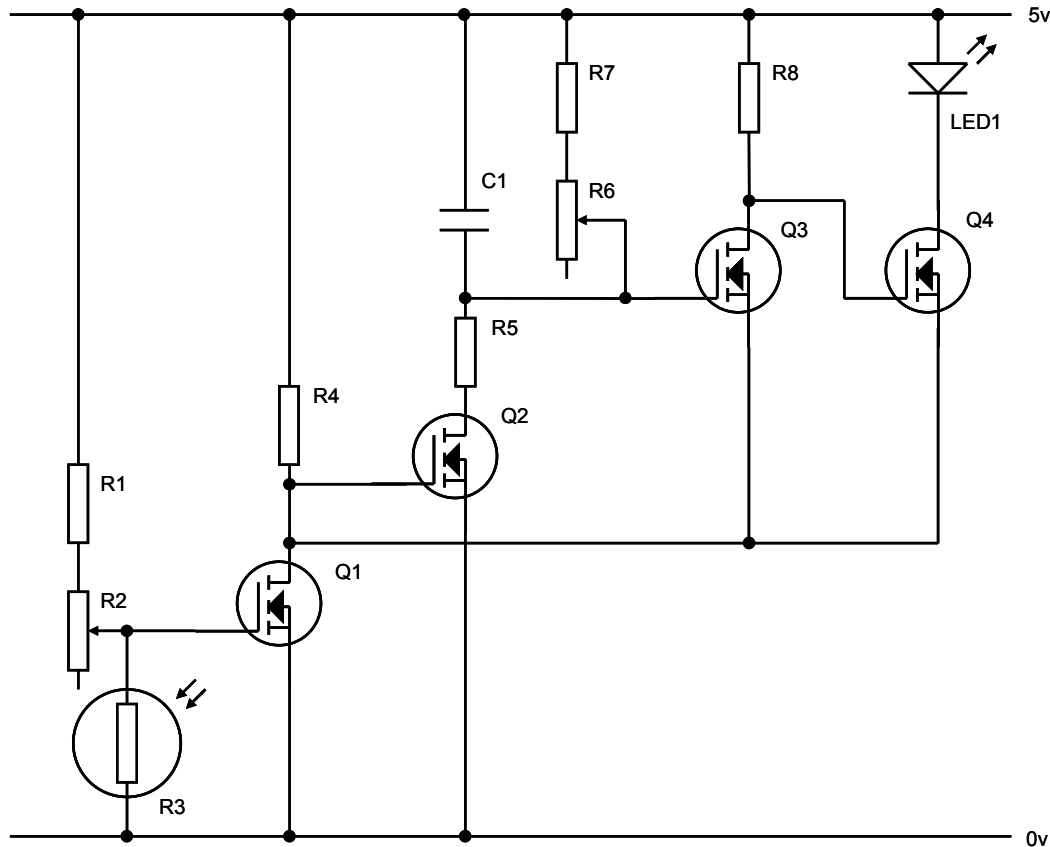

When the Light Dependant Resistor, or LDR for short, (R3) is in day light, the resistance will be low. R1, R2 & R3 are connected together to form a potential divider, where R2 sets the amount of light needed to switch the FET. With the LDR having a low resistance, the voltage on the gate of the FET Q1 will be low and the FET will be off. In this case the two FETs Q3 and Q4, which drive the LED, don't have a 0V connection and as a result the LED won't light. Also whilst Q1 is off, the resistor R4 pulls the gate of FET Q2 into a high state and, as a result, current flows through the drain source of Q2 and charges capacitor C1 through R5.

When the LDR (R3) is dark the resistance is much higher and, consequently, the voltage on the gate of the FET Q1 is high and the FET is turned on. In this case the FETs Q3 and Q4 now have a 0V connection and the LED can operate. Initially the capacitor C1 is charged and, as a result, has 5V across it. This means that the gate of FET Q3 is low, and therefore the FET is turned off. As a result, the gate of Q4 is held in a high state by resistor R8 and the LED is turned on. Over time the Capacitor (C1) is discharged through R6 & R7 and, gradually, the voltage across it drops. As the capacitor voltage reduces, the voltage on the gate of Q3 starts to rise. After a period of time there will be sufficient voltage on the gate of FET Q3 and the FET will turn on. When this happens the gate of FET Q4 will be pulled low and the FET Q4 will switch off, as will the LED.

Resistors R1 & R7 are present so that the circuit can't be damaged if the trimmer potentiometers are set to zero.



Online Information

Two sets of information can be downloaded from the product page where the kit can also be reordered from. The 'Essential Information' contains all of the information that you need to get started with the kit and the 'Teaching Resources' contains more information on soldering, components used in the kit, educational schemes of work and so on and also includes the essentials. Download from:

www.kitronik.co.uk/2139



This kit is designed and manufactured in the UK by Kitronik

Telephone: +44 (0) 845 8380781

Sales email: sales@kitronik.co.uk

Tech support email: support@kitronik.co.uk

Web: www.kitronik.co.uk



www.kitronik.co.uk/twitter



www.kitronik.co.uk/facebook



www.kitronik.co.uk/youtube



www.kitronik.co.uk/google

Every effort has been made to ensure that these notes are correct, however Kitronik accept no responsibility for issues arising from errors / omissions in the notes.

© Kitronik Ltd - Any unauthorised copying / duplication of this booklet or part thereof for purposes except for use with Kitronik project kits is not allowed without Kitronik's prior consent.

