

**40V, Low  $I_Q$ , 3MHz,  
Triple Output Buck/Buck/Boost Synchronous Controller**

**FEATURES**

- **Dual Buck Plus Single Boost Synchronous Controllers**
- **Low Operating  $I_Q$ :**
  - **14 $\mu$ A (14V to 3.3V, Channel 1 On)**
- **Outputs Remain in Regulation Through Cold Crank Down to 1V Input Supply Voltage**
- **Wide Bias Input Voltage Range: 4.5V to 40V**
- **Buck and Boost Output Voltages Up to 40V**
- **Spread Spectrum Operation**
- **$R_{SENSE}$  or DCR Current Sensing**
- **Programmable Fixed Frequency (100kHz to 3MHz)**
- **PassThru™/100% Duty Cycle Capable for Synchronous Boost MOSFET**
- **Phase-Lockable Frequency (100kHz to 3MHz)**
- **Selectable Continuous, Pulse-Skipping, or Low Ripple Burst Mode Operation at Light Loads**
- **Boost Channel Current Monitor Output**
- **Low Shutdown  $I_Q$ : 1.5 $\mu$ A**
- **Small 40-Lead 6mm × 6mm QFN Package**
- **AEC-Q100 Qualified for Automotive Applications**

**APPLICATIONS**

- **Automotive and Transportation**
- **Industrial**
- **Military/Avionics**

**DESCRIPTION**

The **LTC7818** is a high performance triple output (buck/buck/boost) synchronous DC/DC switching regulator controller that drives all N-channel power MOSFET stages. Its constant-frequency current mode architecture allows a phase-lockable switching frequency of up to 3MHz. The LTC7818 operates from a wide 4.5V to 40V input supply range. When biased from the output of the boost converter or another auxiliary supply, the LTC7818 can operate from an input supply as low as 1V after start-up.

The LTC7818 synchronous boost PassThru capability minimizes losses in automotive start-stop applications. The very low no-load quiescent current extends operating run time in battery powered systems. OPTI-LOOP® compensation allows the transient response to be optimized over a wide range of output capacitance and ESR values. The LTC7818 features a precision 0.8V reference for the bucks, 1.2V reference for the boost and a power good output indicator.

The LTC7818 additionally features spread spectrum operation which significantly reduces the peak radiated and conducted noise on both the input and output supplies, making it easier to comply with electromagnetic interference (EMI) standards.

All registered trademarks and trademarks are the property of their respective owners. Protected by U.S. Patents including 5481178, 5705919, 5929620, 6144194, 6177787, 6580258.

**TYPICAL APPLICATION**

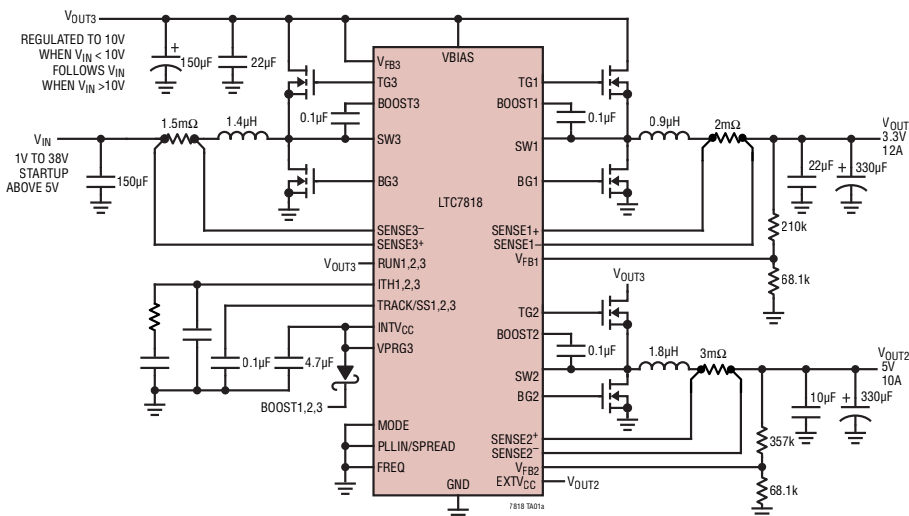

**LTC7818 Response to a Cold Crank Automotive Waveform**

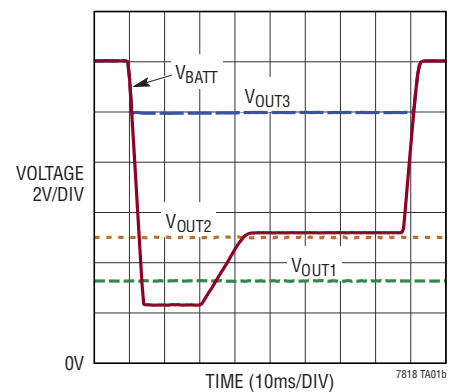

## TABLE OF CONTENTS

<b>Features</b> .....	<b>1</b>	Low Value Resistor Current Sensing.....	19
<b>Applications</b> .....	<b>1</b>	Inductor DCR Current Sensing.....	20
<b>Typical Application</b> .....	<b>1</b>	Setting the Operating Frequency.....	21
<b>Description</b> .....	<b>1</b>	Selecting the Light Load Operating Mode.....	22
<b>Absolute Maximum Ratings</b> .....	<b>3</b>	Power MOSFET Selection .....	23
<b>Order Information</b> .....	<b>3</b>	Boost $C_{IN}$ and $C_{OUT}$ Selection .....	24
<b>Pin Configuration</b> .....	<b>3</b>	Buck $C_{IN}$ and $C_{OUT}$ Selection .....	24
<b>Electrical Characteristics</b> .....	<b>4</b>	Setting the Buck Output Voltage.....	25
<b>Typical Performance Characteristics</b> .....	<b>7</b>	Setting Boost Output Voltage (VPRG3 Pin) .....	26
<b>Pin Functions</b> .....	<b>11</b>	RUN Pins and Undervoltage Lockout.....	26
<b>Functional Diagram</b> .....	<b>13</b>	Soft-Start and Tracking (TRACK/SS1, TRACK/SS2, SS3 Pins).....	26
<b>Operation</b> .....	<b>14</b>	Single Output Two-Phase Operation .....	27
Main Control Loop.....	14	INTV <sub>CC</sub> Regulators.....	28
Power and Bias Supplies ( $V_{BIAS}$ , EXT $V_{CC}$ , and INTV <sub>CC</sub> ) .....	14	Topside MOSFET Driver Supply ( $C_B$ , $D_B$ ) .....	29
Shutdown and Start-Up (RUN1, RUN2, RUN3 and TRACK/SS1, TRACK/SS2, SS3 Pins).....	14	Minimum On-Time Considerations.....	29
Light Load Operation: Burst Mode Operation, Pulse- Skipping, or Forced Continuous Mode (MODE Pin) 15		Boost Channel Current Monitor (IMON3).....	29
Frequency Selection, Spread Spectrum, and Phase- Locked Loop (FREQ and PLLIN/SPREAD Pins).....	16	Fault Conditions: Buck Current Limit and Foldback. 30	
Boost Controller Operation When $V_{IN} > V_{OUT}$ .....	16	Fault Conditions: Buck Overvoltage Protection (Crowbar).....	30
Boost Controller at Low Input Voltage .....	17	Fault Conditions: Overtemperature Protection.....	30
Buck Controller Output Overvoltage Protection .....	17	Phase-Locked Loop and Frequency Synchronization 30	
Buck Foldback Current.....	17	Efficiency Considerations .....	31
Channel 1 Power Good (PGOOD1) .....	17	Checking Transient Response.....	32
Boost Overvoltage Indicator (OV3) .....	17	Buck Design Example .....	32
<b>Applications Information</b> .....	<b>18</b>	PC Board Layout Checklist .....	34
Inductor Value Calculation .....	18	PC Board Layout Debugging.....	35
Inductor Core Selection .....	18	<b>Typical Applications</b> .....	<b>37</b>
Current Sense Selection .....	19	<b>Package Description</b> .....	<b>42</b>
		<b>Revision History</b> .....	<b>43</b>
		<b>Typical Application</b> .....	<b>44</b>
		<b>Related Parts</b> .....	<b>44</b>

## ABSOLUTE MAXIMUM RATINGS

(Note 1)

Bias Input Supply Voltage ( $V_{BIAS}$ )	-0.3V to 40V
BOOST1, BOOST2, BOOST3	-0.3V to 46V
Switch Voltage (SW1, SW2, SW3)	-5V to 40V
RUN1, RUN2, RUN3 Voltages	-0.3V to 40V
SENSE1+, SENSE1- Voltages	-0.3V to 40V
SENSE2+, SENSE2- Voltages	-0.3V to 40V
SENSE3+, SENSE3- Voltages	-0.3V to 40V
EXTV <sub>CC</sub> Voltage	-0.3V to 30V
INTV <sub>CC</sub> , (BOOST1 – SW1), (BOOST2 – SW2), (BOOST3 – SW3)	-0.3V to 6V
TRACK/SS1, TRACK/SS2 Voltages	-0.3V to 6V
ITH1, ITH2, ITH3 Voltages	-0.3V to 2V
$V_{FB3}$ Voltage	-0.3V to 40V
$V_{FB1}$ , $V_{FB2}$ , SS3, IMON3 Voltages	-0.3V to 6V
VPRG3, MODE, PGOOD1 Voltages	-0.3V to 6V
PLLIN/SPREAD, FREQ, OV3 Voltages	-0.3V to 6V
BG1, BG2, BG3, TG1, TG2, TG3	(Note 9)
Operating Junction Temperature Range (Notes 2,8)	
LTC7818E, LTC7818I	-40°C to 125°C
LTC7818H, LTC7818J	-40°C to 150°C
Storage Temperature Range	-65°C to 150°C

## PIN CONFIGURATION

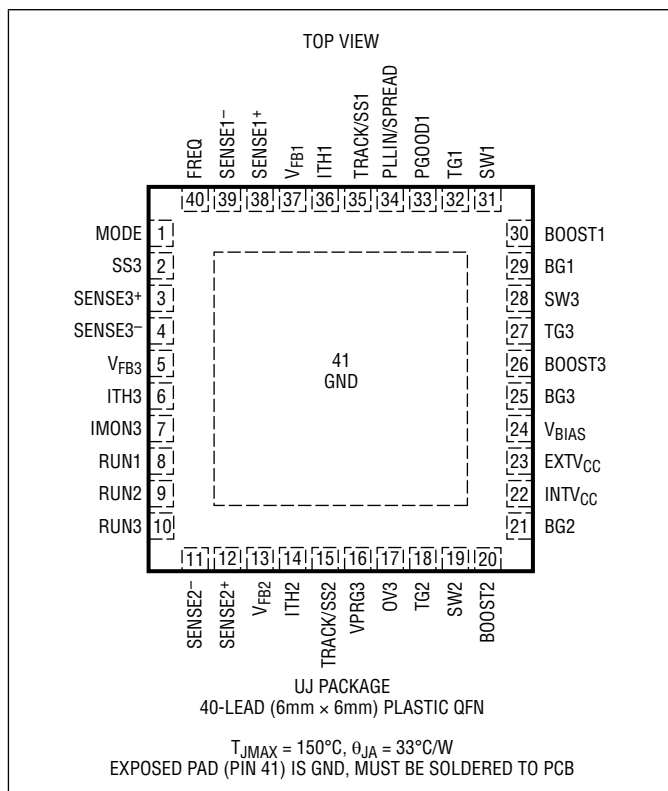

## ORDER INFORMATION

LEAD FREE FINISH	TAPE AND REEL	PART MARKING*	PACKAGE DESCRIPTION	TEMPERATURE RANGE
LTC7818EUJ#PBF	LTC7818EUJ#TRPBF	LTC7818	40-Lead (6mm x 6mm) Plastic QFN	-40°C to 125°C
LTC7818IUJ#PBF	LTC7818IUJ#TRPBF	LTC7818	40-Lead (6mm x 6mm) Plastic QFN	-40°C to 125°C
LTC7818JUJ#PBF	LTC7818JUJ#TRPBF	LTC7818	40-Lead (6mm x 6mm) Plastic QFN	-40°C to 150°C
LTC7818HUJ#PBF	LTC7818HUJ#TRPBF	LTC7818	40-Lead (6mm x 6mm) Plastic QFN	-40°C to 150°C

### AUTOMOTIVE PRODUCTS\*\*

LTC7818EUJ#WPBF	LTC7818EUJ#WTRPBF	LTC7818	40-Lead (6mm x 6mm) Plastic QFN	-40°C to 125°C
LTC7818IUJ#WPBF	LTC7818IUJ#WTRPBF	LTC7818	40-Lead (6mm x 6mm) Plastic QFN	-40°C to 125°C
LTC7818JUJ#WPBF	LTC7818JUJ#WTRPBF	LTC7818	40-Lead (6mm x 6mm) Plastic QFN	-40°C to 150°C
LTC7818HUJ#WPBF	LTC7818HUJ#WTRPBF	LTC7818	40-Lead (6mm x 6mm) Plastic QFN	-40°C to 150°C

Contact the factory for parts specified with wider operating temperature ranges. \*The temperature grade is identified by a label on the shipping container.

**Tape and reel specifications.** Some packages are available in 500 unit reels through designated sales channels with #TRMPBF suffix.

\*\*Versions of this part are available with controlled manufacturing to support the quality and reliability requirements of automotive applications. These models are designated with a #W suffix. Only the automotive grade products shown are available for use in automotive applications. Contact your local Analog Devices account representative for specific product ordering information and to obtain the specific Automotive Reliability reports for these models.

## ELECTRICAL CHARACTERISTICS

The ● indicates specifications which apply over the specified operating junction temperature range, otherwise specifications are for  $T_A = 25^\circ\text{C}$ ,  $V_{\text{BIAS}} = 12\text{V}$ ,  $\text{RUN}_{1,2,3} > 1.25\text{V}$ ,  $\text{EXTV}_{\text{CC}} = 0\text{V}$ ,  $\text{VPRG}_3 = \text{FLOAT}$  unless otherwise noted. (Note 2)

SYMBOL	PARAMETER	CONDITIONS	MIN	TYP	MAX	UNITS
<b>Input Supply (<math>V_{\text{BIAS}}</math>, <math>V_{\text{IN}}</math>)</b>						
$V_{\text{BIAS}}$	Bias Input Supply Operating Voltage Range		4.5		40	V
$V_{\text{IN}}$	Boost Converter Input Supply Operating Range	$V_{\text{BIAS}} \geq 4.5\text{V}$	1		40	V
$I_{\text{Q}}$	$V_{\text{IN}}$ Current in Regulation	Front Page Circuit, 14V to 3.3V, No Load, $\text{RUN}_{2,3} = 0\text{V}$		14		$\mu\text{A}$
<b>Controller Operation</b>						
$V_{\text{OUT}1,2}$	Buck Output Voltage Operating Range		0.8		40	V
$V_{\text{OUT}3}$	Boost Output Voltage Operating Range				40	V
$V_{\text{FB}1,2}$	Buck Regulated Feedback Voltage	(Note 4) $V_{\text{BIAS}} = 4.5\text{V}$ to $40\text{V}$ , $\text{ITH}_{1,2}$ Voltage = $0.6\text{V}$ to $1.2\text{V}$ , $0^\circ\text{C}$ to $85^\circ\text{C}$ , All Grades	● 0.788 0.792	0.800 0.800	0.812 0.808	V V
$V_{\text{FB}3}$	Boost Regulated Feedback Voltage	(Note 4) $V_{\text{BIAS}} = 4.5\text{V}$ to $40\text{V}$ , $\text{ITH}_3$ Voltage = $0.6\text{V}$ to $1.2\text{V}$ , $\text{VPRG}_3 = \text{FLOAT}$ , $\text{VPRG}_3 = 0\text{V}$ , $\text{VPRG}_3 = \text{INTV}_{\text{CC}}$	● 1.177 ● 7.81 ● 9.77	1.195 8.00 10.0	1.213 8.13 10.17	V V V
	Buck Feedback Current	(Note 4)		$\pm 5$	$\pm 50$	nA
	Boost Feedback Current	(Note 4) $\text{VPRG}_3 = \text{FLOAT}$ , $\text{RUN}_3 = 0\text{V}$ , $\text{VPRG}_3 = 0\text{V}$ or $\text{INTV}_{\text{CC}}$ , $\text{RUN}_3 = 2\text{V}$ , $\text{VPRG}_3 = 0\text{V}$ or $\text{INTV}_{\text{CC}}$		$\pm 5$ $\pm 5$ 1	$\pm 50$ $\pm 50$	nA nA $\mu\text{A}$
	Buck Feedback Overvoltage Protection Threshold	Measured at $V_{\text{FB}1,2}$ Relative to Regulated $V_{\text{FB}1,2}$	7	10	13	%
$g_{m1,2,3}$	Transconductance Amplifier $g_m$	(Note 4) $\text{ITH}_{1,2,3} = 1.2\text{V}$ , Sink/Source = $5\mu\text{A}$		1.8		mmho
$V_{\text{SENSE}(\text{MAX})}$	Maximum Current Sense Threshold	$V_{\text{FB}1,2} = 0.7\text{V}$ , $V_{\text{SENSE}1,2}^- = 3.3\text{V}$ , $V_{\text{FB}3} = 1.1\text{V}$ , $V_{\text{SENSE}3}^+ = 12\text{V}$	● 45	50	55	mV
	Matching for Channels 1 & 2	$V_{\text{SENSE}1,2}^- = 3.3\text{V}$ , $V_{\text{FB}2} = \text{INTV}_{\text{CC}}$	-3.5	0	3.5	mV
$I_{\text{SENSE}1,2}^+$	SENSE1,2+ Pin Current	$V_{\text{SENSE}1,2}^+ = 3.3\text{V}$			$\pm 1$	$\mu\text{A}$
$I_{\text{SENSE}3}^-$	SENSE3- Pin Current	$V_{\text{SENSE}3}^- = 12\text{V}$			$\pm 1$	$\mu\text{A}$
$I_{\text{SENSE}1}^-$	SENSE1- Pin Current	$V_{\text{SENSE}1}^- \leq 2.7\text{V}$ , $3.2\text{V} \leq V_{\text{SENSE}1}^- < \text{INTV}_{\text{CC}} - 0.5\text{V}$ , $V_{\text{SENSE}1}^- > \text{INTV}_{\text{CC}} + 0.5\text{V}$		2 40 660		$\mu\text{A}$ $\mu\text{A}$ $\mu\text{A}$
$I_{\text{SENSE}2}^-$	SENSE2- Pin Current	$V_{\text{SENSE}2}^- = 3.3\text{V}$ , $V_{\text{SENSE}2}^- > \text{INTV}_{\text{CC}} + 0.5\text{V}$		620	$\pm 2$	$\mu\text{A}$ $\mu\text{A}$
$I_{\text{SENSE}3}^+$	SENSE3+ Pin Current	$V_{\text{SENSE}3}^+ = 3.3\text{V}$ , $V_{\text{SENSE}3}^+ > \text{INTV}_{\text{CC}} + 0.5\text{V}$		660	$\pm 2$	$\mu\text{A}$ $\mu\text{A}$
	Soft-Start Charge Current	$V_{\text{TRACK/SS}1,2} = 0\text{V}$ , $V_{\text{SS}3} = 0\text{V}$	10	12.5	15	$\mu\text{A}$
	RUN Pin ON Threshold	$V_{\text{RUN}1,2,3}$ Rising	● 1.15	1.20	1.25	V
	RUN Pin Hysteresis	$V_{\text{RUN}1,2,3}$ Falling		100		mV
<b>DC Supply Current (Note 5)</b>						
	$V_{\text{BIAS}}$ Shutdown Current	$\text{RUN}_1, 2, 3 = 0\text{V}$		1.5		$\mu\text{A}$
	$V_{\text{BIAS}}$ Sleep Mode Current	$V_{\text{SENSE}1}^- < 3.2\text{V}$ , $\text{EXTV}_{\text{CC}} = 0\text{V}$ , One Channel On, All Channels On		15 18	24 30	$\mu\text{A}$ $\mu\text{A}$

**ELECTRICAL CHARACTERISTICS** The ● indicates specifications which apply over the specified operating junction temperature range, otherwise specifications are for  $T_A = 25^\circ\text{C}$ ,  $V_{\text{BIAS}} = 12\text{V}$ ,  $\text{RUN}_{1,2,3} > 1.25\text{V}$ ,  $\text{EXTV}_{\text{CC}} = 0\text{V}$ ,  $\text{VPRG}_3 = \text{FLOAT}$  unless otherwise noted. (Note 2)

SYMBOL	PARAMETER	CONDITIONS	MIN	TYP	MAX	UNITS
	Sleep Mode Current (Note 3) Only Channel 1 On	$V_{\text{SENSE1}^-} \geq 3.2\text{V}$ $V_{\text{BIAS}}$ Current, $\text{EXTV}_{\text{CC}} = 0\text{V}$ $V_{\text{BIAS}}$ Current, $\text{EXTV}_{\text{CC}} = 4.8\text{V}$ $\text{EXTV}_{\text{CC}}$ Current, $\text{EXTV}_{\text{CC}} \geq 4.8\text{V}$ $\text{SENSE1}^-$ Current		5 1 5 10	9 4 10 18	$\mu\text{A}$ $\mu\text{A}$ $\mu\text{A}$ $\mu\text{A}$
	Sleep Mode Current (Note 3) All Channels On	$V_{\text{SENSE1}^-} \geq 3.2\text{V}$ , $\text{EXTV}_{\text{CC}} \geq 4.8\text{V}$ $V_{\text{BIAS}}$ Current $\text{EXTV}_{\text{CC}}$ Current $\text{SENSE1}^-$ Current		1 8 16	4 14 26	$\mu\text{A}$ $\mu\text{A}$ $\mu\text{A}$
	Pulse-Skipping or Forced Continuous Mode $V_{\text{BIAS}}$ or $\text{EXTV}_{\text{CC}}$ Current (Note 3)	One Channel On All Channels On		1.5 3		$\text{mA}$ $\text{mA}$

#### Gate Drivers

	TG or BG On-Resistance	Pull-up Pull-down		2.0 1.0		$\Omega$ $\Omega$
	TG or BG Transition Time Rise Time Fall Time	(Note 6) $C_{\text{LOAD}} = 3300\text{pF}$ $C_{\text{LOAD}} = 3300\text{pF}$		25 15		$\text{ns}$ $\text{ns}$
	TG Off to BG On Delay Synchronous Switch-On Delay Time	$C_{\text{LOAD}} = 3300\text{pF}$ Each Driver Bucks (Channels 1, 2) Boost (Channel 3)		15 15		$\text{ns}$ $\text{ns}$
	BG Off to TG On Delay Top Switch-On Delay Time	$C_{\text{LOAD}} = 3300\text{pF}$ Each Driver Bucks (Channels 1, 2) Boost (Channel 3)		15 15		$\text{ns}$ $\text{ns}$
$t_{\text{ON(MIN)1,2}}$	Buck TG Minimum On-Time	(Note 7)		40		$\text{ns}$
$t_{\text{ON(MIN)3}}$	Boost BG Minimum On-Time	(Note 7)		80		$\text{ns}$
	Maximum Duty Factor for TG	Bucks (Channels 1,2), $\text{FREQ} = 0\text{V}$ Boost (Channel 3) in Overvoltage	98	99 100		% %
	Maximum Duty Factor for BG	Bucks (Channels 1,2) in Overvoltage Boost (Channel 3), $\text{FREQ} = 0\text{V}$		100 93		% %
	BOOST3 Charge Pump Available Output Current	$V_{\text{BOOST3}} = 16\text{V}$ , $V_{\text{SW3}} = 12\text{V}$ , $\text{FREQ} = 0\text{V}$ , Forced Continuous Mode	20	50		$\mu\text{A}$
	IMON3 Current Monitor Output Voltage	$V_{\text{SENSE3}^+} = 12\text{V}$ , $V_{\text{SENSE3}^+} - V_{\text{SENSE3}^-} = 50\text{mV}$ $V_{\text{SENSE3}^+} = 12\text{V}$ , $V_{\text{SENSE3}^+} - V_{\text{SENSE3}^-} = 15\text{mV}$	1.3 0.6	1.4 0.7	1.5 0.8	$\text{V}$ $\text{V}$

#### INTV<sub>CC</sub> Low Dropout (LDO) Linear Regulator

	INTV <sub>CC</sub> Regulation Point		4.9	5.1	5.3	$\text{V}$
	INTV <sub>CC</sub> Load Regulation	$I_{\text{CC}} = 0\text{mA}$ to $100\text{mA}$ , $V_{\text{BIAS}} \geq 6\text{V}$ $I_{\text{CC}} = 0\text{mA}$ to $100\text{mA}$ , $\text{EXTV}_{\text{CC}} \geq 6\text{V}$		1.2 1.2	2 2	% %
	EXTV <sub>CC</sub> LDO Switchover Voltage	EXTV <sub>CC</sub> Rising	4.5	4.7	4.8	$\text{V}$
	EXTV <sub>CC</sub> Switchover Hysteresis			250		$\text{mV}$
UVLO	Undervoltage Lockout	INTV <sub>CC</sub> Rising INTV <sub>CC</sub> Falling	● ●	4.10 3.75	4.20 3.85	4.35 4.00 $\text{V}$ $\text{V}$

#### Spread Spectrum Oscillator and Phase-Locked Loop

$f_{\text{osc}}$	Low Fixed Frequency	$V_{\text{FREQ}} = 0\text{V}$ , $\text{PLLIN/SPREAD} = 0\text{V}$		330	380	430	$\text{kHz}$
	High Fixed Frequency	$V_{\text{FREQ}} = \text{INTV}_{\text{CC}}$ , $\text{PLLIN/SPREAD} = 0\text{V}$	●	2.0	2.25	2.5	$\text{MHz}$
	Programmable Frequency	$R_{\text{FREQ}} = 374\text{k}\Omega$ , $\text{PLLIN/SPREAD} = 0\text{V}$ $R_{\text{FREQ}} = 75\text{k}\Omega$ , $\text{PLLIN/SPREAD} = 0\text{V}$ $R_{\text{FREQ}} = 12\text{k}\Omega$ , $\text{PLLIN/SPREAD} = 0\text{V}$		450	500	550	$\text{kHz}$ $\text{kHz}$ $\text{MHz}$
					3		
●			0.1		3	$\text{MHz}$	

Rev. B

## ELECTRICAL CHARACTERISTICS

The ● indicates specifications which apply over the specified operating junction temperature range, otherwise specifications are for  $T_A = 25^\circ\text{C}$ ,  $V_{\text{BIAS}} = 12\text{V}$ ,  $\text{RUN}_{1,2,3} > 1.25\text{V}$ ,  $\text{EXTV}_{\text{CC}} = 0\text{V}$ ,  $\text{VPRG}_3 = \text{FLOAT}$  unless otherwise noted. (Note 2)

SYMBOL	PARAMETER	CONDITIONS	MIN	TYP	MAX	UNITS
	PLLIN Input High Level		● 2.2			V
	PLLIN Input Low Level		●		0.5	V
	Spread Spectrum Frequency Range (Relative to $f_{\text{OSC}}$ )	PLLIN/SPREAD = INTV <sub>CC</sub> Minimum Frequency Maximum Frequency		-12 +15		% %

### PGOOD1 and OV3 Outputs

	PGOOD1 Voltage Low	$I_{\text{PGOOD1}} = 2\text{mA}$		0.2	0.4	V
	PGOOD1 Leakage Current	$V_{\text{PGOOD1}} = 5\text{V}$			±1	μA
	PGOOD1 Trip Level	$V_{\text{FB1}}$ Rising Hysteresis	7	10	13	%
	$V_{\text{FB1}}$ Relative to Set Regulation Point	$V_{\text{FB1}}$ Falling Hysteresis	-13	-10	-7	%
	PGOOD1 Delay for Reporting a Fault			25		μs
	OV3 Voltage Low	$I_{\text{OV3}} = 2\text{mA}$		0.2	0.4	V
	OV3 Leakage Current	$V_{\text{OV3}} = 5\text{V}$			±1	μA
	OV3 Trip Level	$V_{\text{FB3}}$ Rising Hysteresis	7	10	13	%
	$V_{\text{FB3}}$ Relative to Set Regulation Point			2.5		%

**Note 1:** Stresses beyond those listed under Absolute Maximum Ratings may cause permanent damage to the device. Exposure to any Absolute Maximum Rating condition for extended periods may affect device reliability and lifetime.

**Note 2:** The LTC7818 is tested under pulsed load conditions such that  $T_J \approx T_A$ . The LTC7818E is guaranteed to meet specifications from  $0^\circ\text{C}$  to  $85^\circ\text{C}$  junction temperature. Specifications over the  $-40^\circ\text{C}$  to  $125^\circ\text{C}$  operating junction temperature range are assured by design, characterization and correlation with statistical process controls. The LTC7818I is guaranteed over the  $-40^\circ\text{C}$  to  $125^\circ\text{C}$  operating junction temperature range, and the LTC7818J/LTC7818H are guaranteed over the  $-40^\circ\text{C}$  to  $150^\circ\text{C}$  operating junction temperature range. High junction temperatures degrade operating lifetimes; operating lifetime is derated for junction temperatures greater than  $125^\circ\text{C}$ . Note that the maximum ambient temperature consistent with these specifications is determined by specific operating conditions in conjunction with board layout, the rated package thermal impedance and other environmental factors. The junction temperature ( $T_J$ , in  $^\circ\text{C}$ ) is calculated from the ambient temperature ( $T_A$ , in  $^\circ\text{C}$ ) and power dissipation ( $P_D$ , in Watts) according to the formula:  $T_J = T_A + (P_D \cdot \theta_{JA})$ , where  $\theta_{JA}$  (in  $^\circ\text{C}/\text{W}$ ) is the package thermal impedance.

**Note 3:** When  $\text{SENSE1}^- \geq 3.2\text{V}$  or  $\text{EXTV}_{\text{CC}} \geq 4.8\text{V}$ ,  $V_{\text{BIAS}}$  supply current is transferred to these pins to reduce the total input supply quiescent current.  $\text{SENSE1}^-$  bias current is reflected to the buck channel 1 input supply ( $V_{\text{IN1}}$ ) by the formula  $I_{\text{VIN1}} = I_{\text{SENSE1}^-} \cdot V_{\text{OUT1}} / (V_{\text{IN1}} \cdot \eta)$ , where  $\eta$  is the efficiency.  $\text{EXTV}_{\text{CC}}$  bias current is similarly reflected to a buck channel input supply when biased by a buck channel output. To minimize

input supply current, select channel 1 to be the lowest output voltage greater than  $3.2\text{V}$  and connect  $\text{EXTV}_{\text{CC}}$  to the lowest output voltage greater than  $4.8\text{V}$ .

**Note 4:** The LTC7818 is tested in a feedback loop that servos  $V_{\text{ITH1,2,3}}$  to a specified voltage and measures the resultant  $V_{\text{FB1,2,3}}$ . The specifications at  $0^\circ\text{C}$  and  $85^\circ\text{C}$  are not tested in production and are assured by design, characterization and correlation to production testing at other temperatures ( $125^\circ\text{C}$  for the LTC7818E/LTC7818I,  $150^\circ\text{C}$  for the LTC7818J/LTC7818H).

**Note 5:** Dynamic supply current is higher due to the gate charge being delivered at the switching frequency. See Applications Information.

**Note 6:** Rise and fall times are measured using 10% and 90% levels. Delay times are measured using 50% levels.

**Note 7:** The minimum on-time condition is specified for an inductor peak-to-peak ripple current  $> 40\%$  of  $I_{\text{L(MAX)}}$  (See Minimum On-Time Considerations in the Applications Information section).

**Note 8:** This IC includes overtemperature protection that is intended to protect the device during momentary overload conditions. The maximum rated junction temperature will be exceeded when this protection is active. Continuous operation above the specified absolute maximum operating junction temperature may impair device reliability or permanently damage the device.

**Note 9:** Do not apply a voltage or current source to these pins. They must be connected to capacitive loads only, otherwise permanent damage may occur.

# TYPICAL PERFORMANCE CHARACTERISTICS

**Efficiency and Power Loss vs Output Current (Buck)**

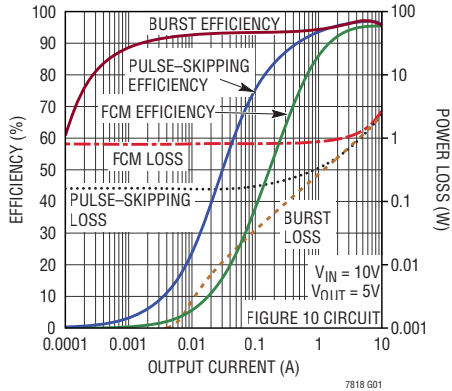

**Efficiency and Power Loss vs Output Current (Buck)**

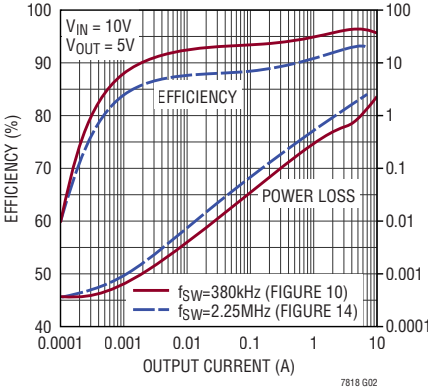

**Efficiency vs Input Voltage (Buck)**

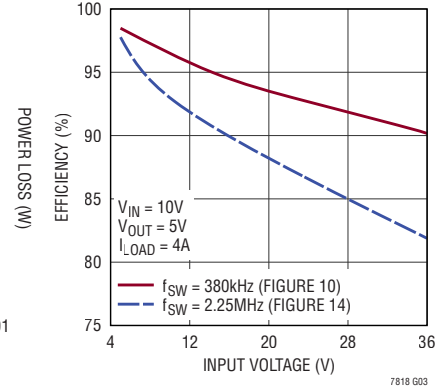

**Load Step (Buck) Burst Mode Operation**

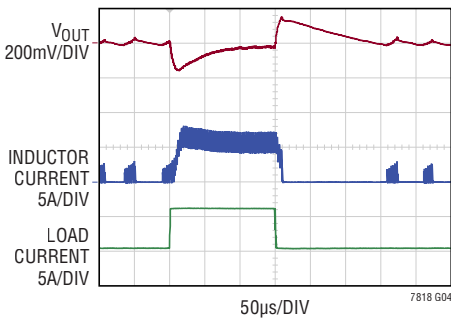

$V_{IN} = 10V$   
 $V_{OUT} = 5V$   
 300mA TO 6A LOAD STEP  
 FIGURE 10 CIRCUIT

**Load Step (Buck) Pulse-Skipping Mode**

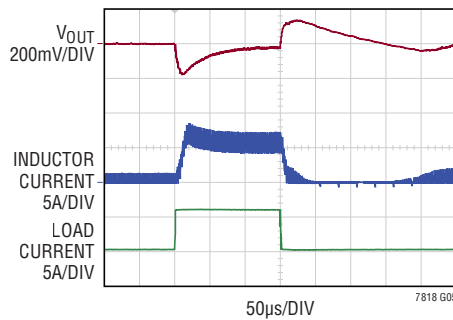

$V_{IN} = 10V$   
 $V_{OUT} = 5V$   
 300mA TO 6A LOAD STEP  
 FIGURE 10 CIRCUIT

**Load Step (Buck) Forced Continuous Mode**

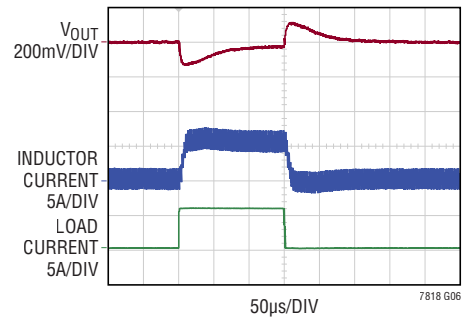

$V_{IN} = 10V$   
 $V_{OUT} = 5V$   
 300mA TO 6A LOAD STEP  
 FIGURE 10 CIRCUIT

**Inductor Current at Light Load (Buck)**

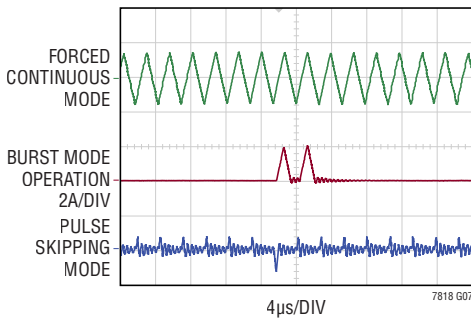

$V_{IN} = 10V$   
 $V_{OUT} = 5V$   
 NO LOAD  
 FIGURE 10 CIRCUIT

**Soft Start-Up**

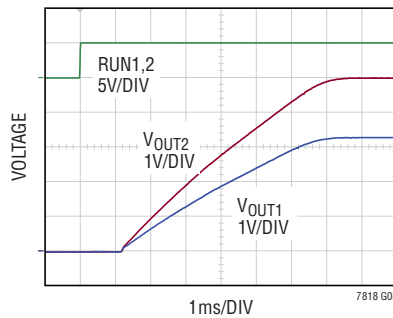

$V_{IN} = 10V$   
 FIGURE 10 CIRCUIT

**Buck Regulated Feedback Voltage vs Temperature**

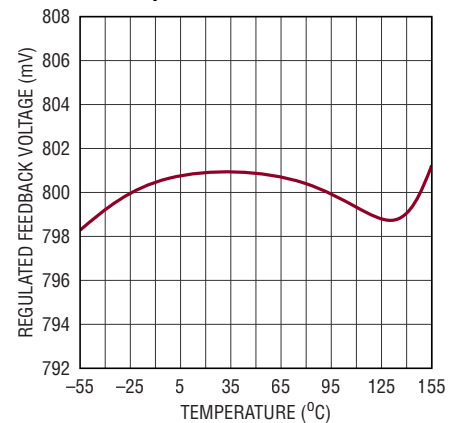

7818 G09

## TYPICAL PERFORMANCE CHARACTERISTICS

### Efficiency and Power Loss vs Output Current (Boost)

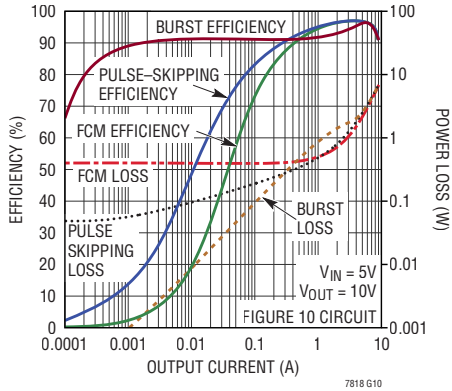

### Efficiency vs Output Current (Boost)

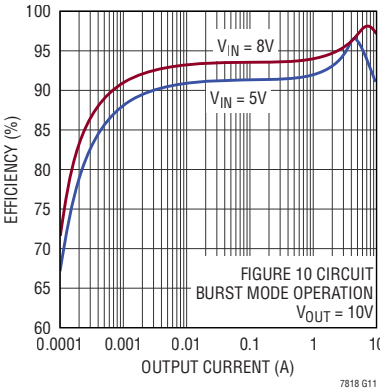

### Efficiency vs Input Voltage (Boost)

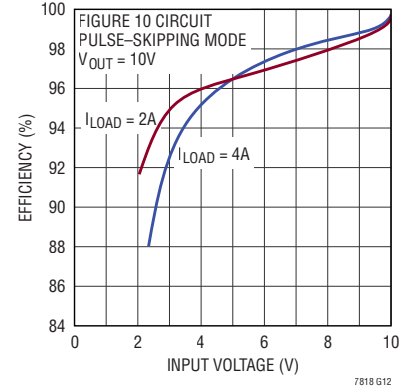

### Load Step (Boost) Burst Mode Operation

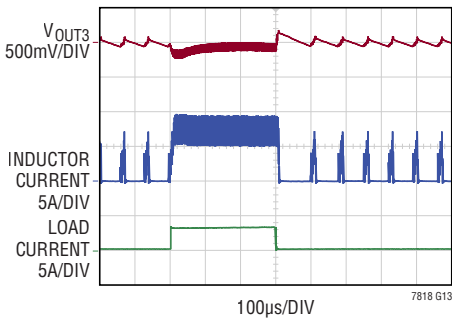

$V_{IN} = 5V$   
 $V_{OUT} = 10V$   
 300mA TO 3.3A LOAD STEP  
 FIGURE 10 CIRCUIT

### Load Step (Boost) Pulse-Skipping Mode

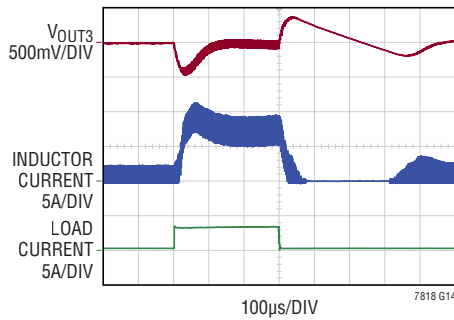

$V_{IN} = 5V$   
 $V_{OUT} = 10V$   
 300mA TO 3.3A LOAD STEP  
 FIGURE 10 CIRCUIT

### Load Step (Boost) Forced Continuous Mode

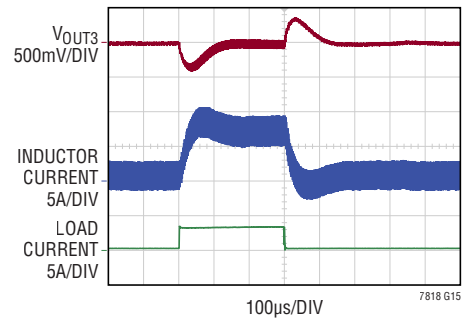

$V_{IN} = 5V$   
 $V_{OUT} = 10V$   
 300mA TO 3.3A LOAD STEP  
 FIGURE 10 CIRCUIT

### Inductor Current at Light Load (Boost)

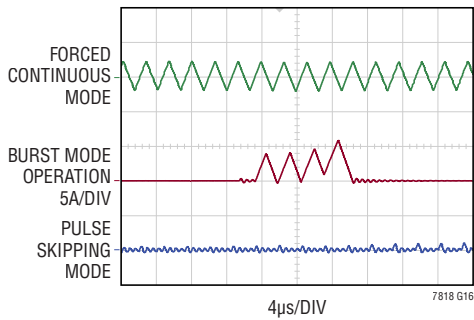

$V_{IN} = 5V$   
 $V_{OUT} = 10V$   
 NO LOAD  
 FIGURE 10 CIRCUIT

### Soft Start-Up (Boost)

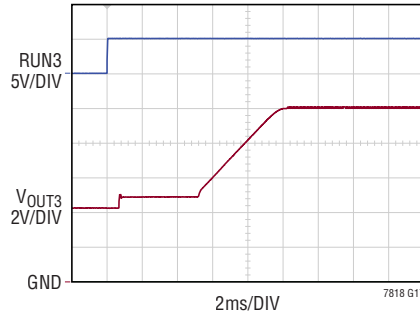

$V_{IN} = 5V$   
 FIGURE 10 CIRCUIT

### Boost Regulated Feedback Voltage vs Temperature

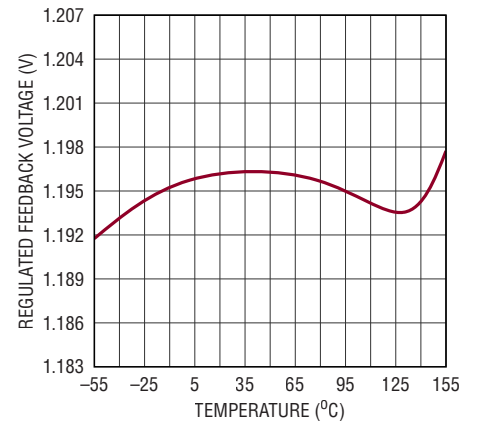

7818 G18



# TYPICAL PERFORMANCE CHARACTERISTICS

**Maximum Current Sense Threshold vs ITH Voltage**

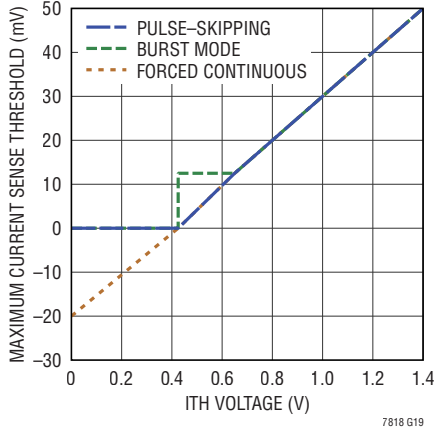

7818 G19

**SENSE1,2<sup>-</sup> and SENSE3<sup>+</sup> Current vs Voltage**

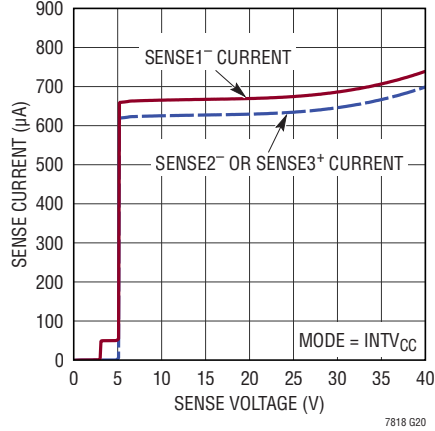

7818 G20

**Maximum Current Sense Threshold vs SENSE Common Mode Voltage**

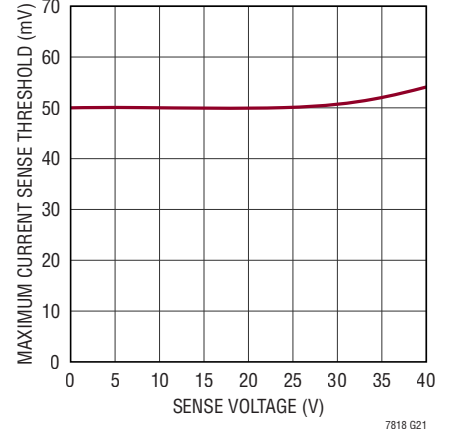

7818 G21

**Buck Foldback Current Limit**

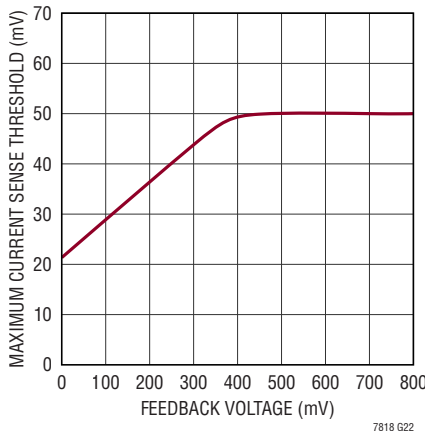

7818 G22

**SENSE1,2<sup>-</sup> and SENSE3<sup>+</sup> Input Current vs Temperature**

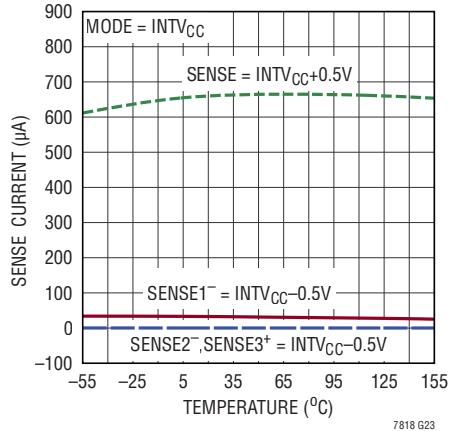

7818 G23

**SENSE1,2<sup>+</sup> and SENSE3<sup>-</sup> Input Current vs Temperature**

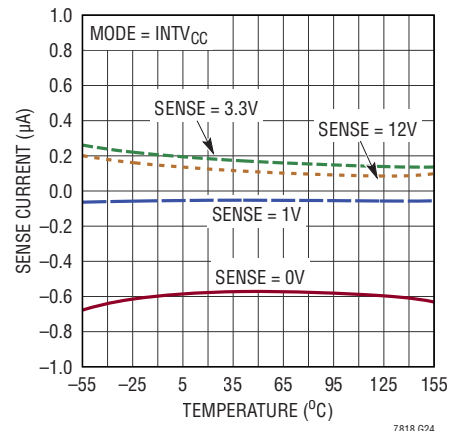

7818 G24

**Oscillator Frequency vs Temperature**

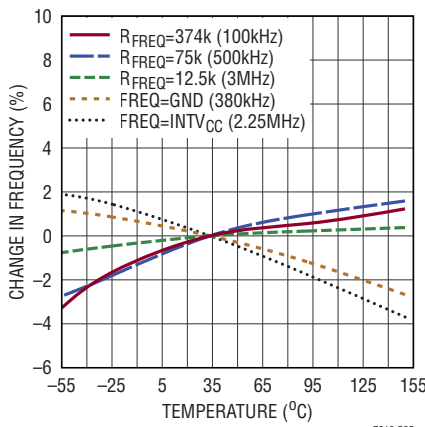

7818 G25

**Output Voltage Noise Spectrum**

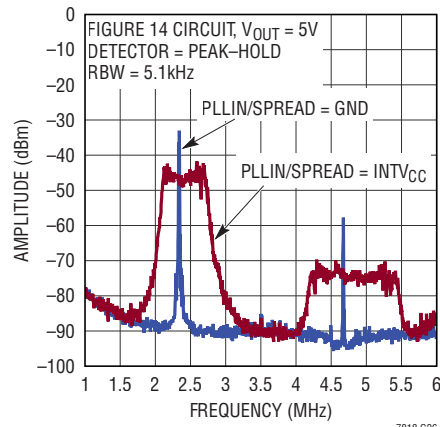

7818 G26

**Boost Current Monitor Voltage vs Sense Voltage**

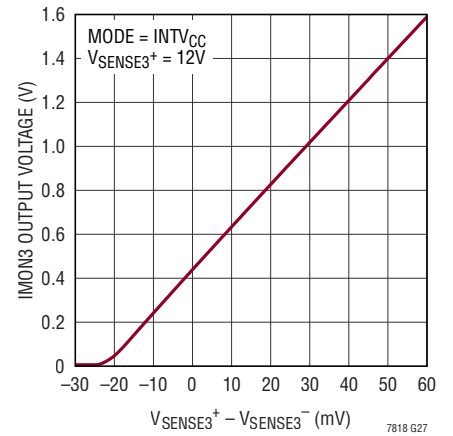

7818 G27

## TYPICAL PERFORMANCE CHARACTERISTICS

### INTV<sub>CC</sub> Voltage vs Current

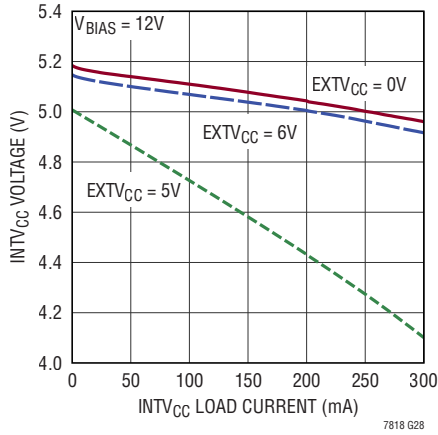

### EXTV<sub>CC</sub> Switchover and INTV<sub>CC</sub> Voltage vs Temperature

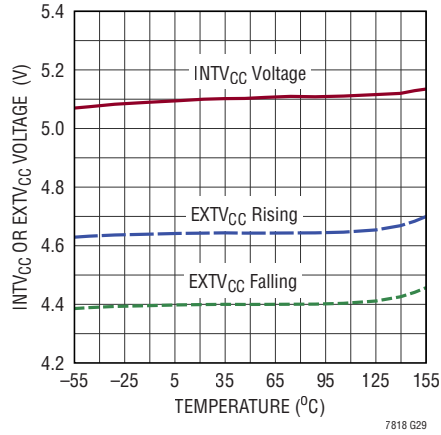

### INTV<sub>CC</sub> Undervoltage Lockout Thresholds vs Temperature

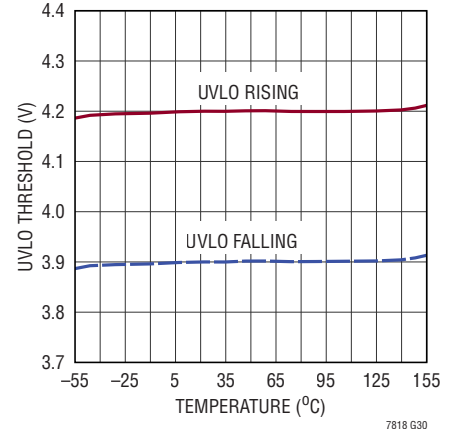

### RUN Pin Thresholds vs Temperature

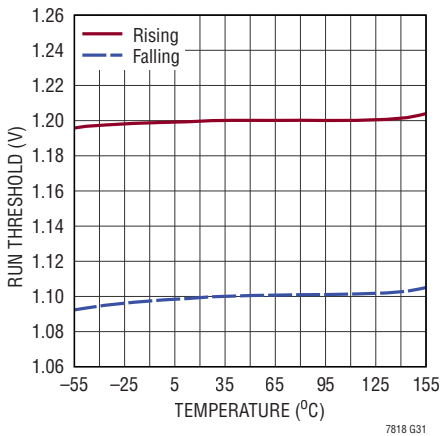

### V<sub>BIAS</sub> Quiescent Current vs Temperature

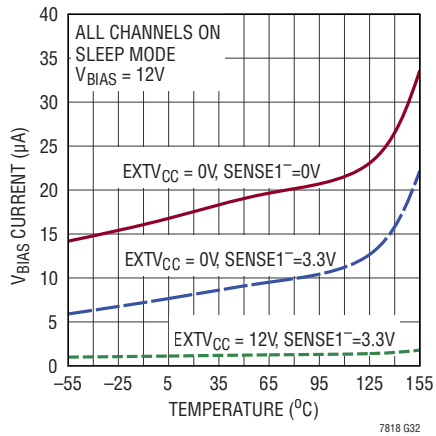

### Shutdown Current vs V<sub>BIAS</sub> Input Voltage

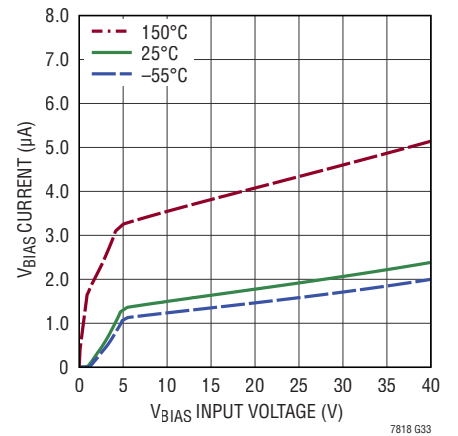

### BOOST3 Charge Pump Output Current vs Frequency

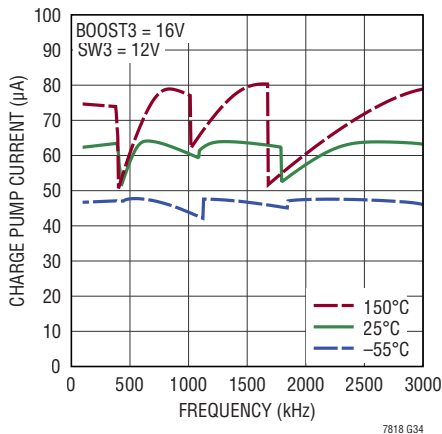

### BOOST3 Charge Pump Output Current vs SW3 Voltage

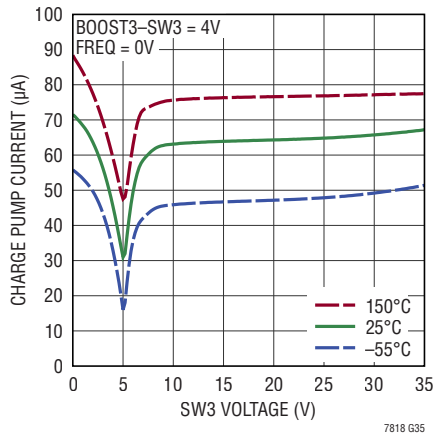

### TRACK/SS Pull-Up Current vs Temperature

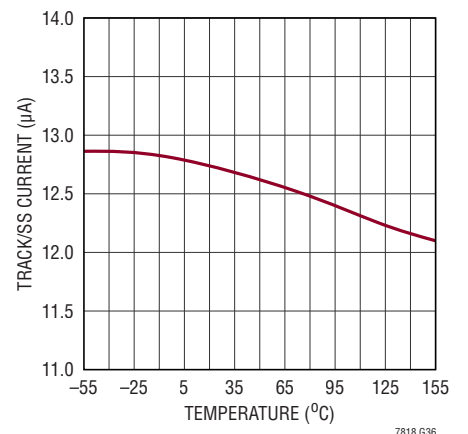

## PIN FUNCTIONS

**MODE (Pin 1):** Mode Select Input. This input, which acts on all three channels, determines how the LTC7818 operates at light loads. Pulling this pin to ground selects Burst Mode operation. An internal 100k resistor to ground also invokes Burst Mode operation when the pin is floating. Tying this pin to INTV<sub>CC</sub> forces continuous inductor current operation. Tying this pin to INTV<sub>CC</sub> through a 100k resistor selects pulse-skipping operation.

**IMON3 (Pin 7):** Boost Channel Current Monitor. This pin generates a voltage between 0.4V and 1.4V that corresponds to the boost channel inductor current between zero current and full load. Optionally place a capacitor from this pin to ground to average the current reading.

**RUN1, RUN2, RUN3 (Pins 8, 9, 10):** Run Control Inputs for Each Controller. Forcing any of these pins below 1.1V disables switching of the corresponding controller. Forcing all of these pins below 0.7V shuts down the entire LTC7818, reducing the quiescent current to approximately 1.5 $\mu$ A. These pins can be tied to V<sub>IN</sub> or V<sub>BIAS</sub> for always-on operation.

**VPRG3 (Pin 16):** Boost Output Voltage Programming Pin. This pin sets the boost channel to adjustable output voltage or to a fixed output voltage. Floating this pin allows the boost channel output to be programmed through the V<sub>FB3</sub> pin using external resistors, regulating V<sub>FB3</sub> to the 1.2V reference. Connecting this pin to GND or INTV<sub>CC</sub> programs the boost channel output to 8V or 10V (respectively), with V<sub>FB3</sub> directly connected to the output.

**OV3 (Pin 17):** Overvoltage Open-Drain Logic Output for the Boost Regulator. OV3 is pulled to ground when the voltage on the V<sub>FB3</sub> pin is less than 110% of its set point, and becomes high impedance when V<sub>FB3</sub> exceeds 110% of its set point.

**INTV<sub>CC</sub> (Pin 22):** Output of the Internal 5.1V Low Dropout Regulator. The driver and control circuits are powered by this supply. Must be decoupled to ground with a minimum of 4.7 $\mu$ F ceramic or tantalum capacitor.

**EXTV<sub>CC</sub> (Pin 23):** External Power Input to an Internal LDO Connected to INTV<sub>CC</sub>. This LDO supplies INTV<sub>CC</sub> power, bypassing the internal LDO powered from V<sub>BIAS</sub> whenever EXTV<sub>CC</sub> is higher than 4.7V. See INTV<sub>CC</sub> Regulators in the Applications Information section. Do not exceed 30V on this pin. Connect this pin to ground if the EXTV<sub>CC</sub> LDO is not used.

**V<sub>BIAS</sub> (Pin 24):** Main Bias Input Supply Pin. A bypass capacitor should be tied between this pin and ground.

**PLLIN/SPREAD (Pin 34):** External Synchronization Input and Spread Spectrum Selection. When an external clock is applied to this pin, the phase-locked loop will force the rising TG1 signal to be synchronized with the rising edge of the external clock. When an external clock is present, the regulators operate in pulse-skipping mode if it is selected by the MODE pin, or in forced continuous mode otherwise. When not synchronizing to an external clock, tie this input to INTV<sub>CC</sub> to enable spread spectrum dithering of the oscillator or to ground to disable spread spectrum.

**FREQ (Pin 40):** Frequency Control Pin for the Internal Oscillator. Connect to ground to set the switching frequency to 380kHz. Connect to INTV<sub>CC</sub> to set the switching frequency to 2.25MHz. Frequencies between 100kHz and 3MHz can be programmed using a resistor between the FREQ pin and ground. Minimize the capacitance on this pin.

**BG1, BG2, BG3 (Pins 29, 21, 25):** High Current Gate Drives for Bottom N-Channel MOSFETs. Voltage swing at these pins is from ground to INTV<sub>CC</sub>.

**BOOST1, BOOST2, BOOST3 (Pins 30, 20, 26):** Bootstrapped Supplies to the Top Side Floating Drivers. Connect capacitors between the corresponding BOOST and SW pins for each channel. Also connect Schottky diodes between the BOOST1 and INTV<sub>CC</sub> pins, the BOOST2 and INTV<sub>CC</sub> pins and the BOOST3 and INTV<sub>CC</sub> pins. Voltage swing at the BOOST1,2 pins is from INTV<sub>CC</sub> to (V<sub>IN</sub>+INTV<sub>CC</sub>). Voltage swing at the BOOST3 pin is from INTV<sub>CC</sub> to (V<sub>OUT3</sub>+INTV<sub>CC</sub>).

## PIN FUNCTIONS

**SW1, SW2, SW3 (Pins 31, 19, 28):** Switch Node Connections to Inductors.

**TG1, TG2, TG3 (Pins 32, 18, 27):** High Current Gate Drives for Top N-Channel MOSFETs. These are the outputs of floating drivers with a voltage swing of  $INTV_{CC}$  superimposed on the switch node voltage SW.

**PGOOD1 (Pin 33):** Open-Drain Power Good Output. The  $V_{FB1}$  pin is monitored to ensure that  $V_{OUT1}$  is in regulation. When  $V_{OUT1}$  is not within  $\pm 10\%$  of its regulation point, the PGOOD1 pin is pulled low.

**TRACK/SS1, TRACK/SS2, SS3 (Pins 35, 15, 2):** External Tracking and Soft-Start Input. For the buck channels, the LTC7818 regulates the  $V_{FB1,2}$  voltage to the lesser of 0.8V or the voltage on the TRACK/SS1,2 pin. For the boost channel, the LTC7818 regulates  $V_{FB3}$  to the lesser of 1.2V or the voltage on the SS3 pin. Internal 12.5 $\mu$ A pull-up current sources are connected to these pins. A capacitor to ground sets the startup ramp time to the final regulated output voltage. The ramp time is equal to 0.65ms for every 10nF of capacitance for the buck channels and 1ms for every 10nF for the boost channel. Alternatively, a resistor divider on another voltage supply connected to the TRACK/SS pins of the buck channels allows the LTC7818 output to track the other supply during startup.

**ITH1, ITH2, ITH3 (Pins 36, 14, 6):** Error Amplifier Outputs and Regulator Compensation Points. Each associated channel's current comparator trip point increases with this control voltage. Place compensation components between the ITH pins and ground.

**$V_{FB1}$ ,  $V_{FB2}$  (Pins 37, 13):** Buck Controller Feedback Inputs. Connect an external resistor divider between the output voltage and the  $V_{FB}$  pin to set the regulated output voltage. Tie  $V_{FB2}$  to  $INTV_{CC}$  to configure the bucks for a two-phase single output application, in which both buck channels share  $V_{FB1}$ , ITH1, and TRACK/SS1.

**$V_{FB3}$  (Pin 5):** Boost Controller Feedback Input. When VPRG3 is floating, connect an external resistor divider between the boost output voltage and the  $V_{FB3}$  pin to set the regulated voltage. When VPRG3 is connected to ground or  $INTV_{CC}$ , tie  $V_{FB3}$  directly to the boost converter output.

**SENSE1<sup>+</sup>, SENSE2<sup>+</sup>, SENSE3<sup>+</sup> (Pins 38, 12, 3):** The Positive (+) Input to the Differential Current Comparators. The ITH pin voltage and controlled offsets between the SENSE<sup>-</sup> and SENSE<sup>+</sup> pins in conjunction with  $R_{SENSE}$  set the current trip threshold. For the boost channel, the SENSE3<sup>+</sup> pin supplies current to the current comparator when it is greater than  $INTV_{CC}$ .

**SENSE1<sup>-</sup>, SENSE2<sup>-</sup>, SENSE3<sup>-</sup> (Pins 39, 11, 4):** The Negative (-) Input to the Differential Current Comparators. When SENSE1<sup>-</sup> is 3.2V or greater, it supplies the majority of the sleep mode quiescent current instead of  $V_{BIAS}$ , further reducing the input-referred quiescent current. For the buck channels, the SENSE<sup>-</sup> pins supply current to the current comparators when they are greater than  $INTV_{CC}$ .

**GND (Exposed Pad Pin 41):** Ground. Connects to the sources of bottom N-channel MOSFETs and the (-) terminal(s) of decoupling capacitors. The exposed pad must be soldered to PCB ground for rated electrical and thermal performance.

FUNCTIONAL DIAGRAM

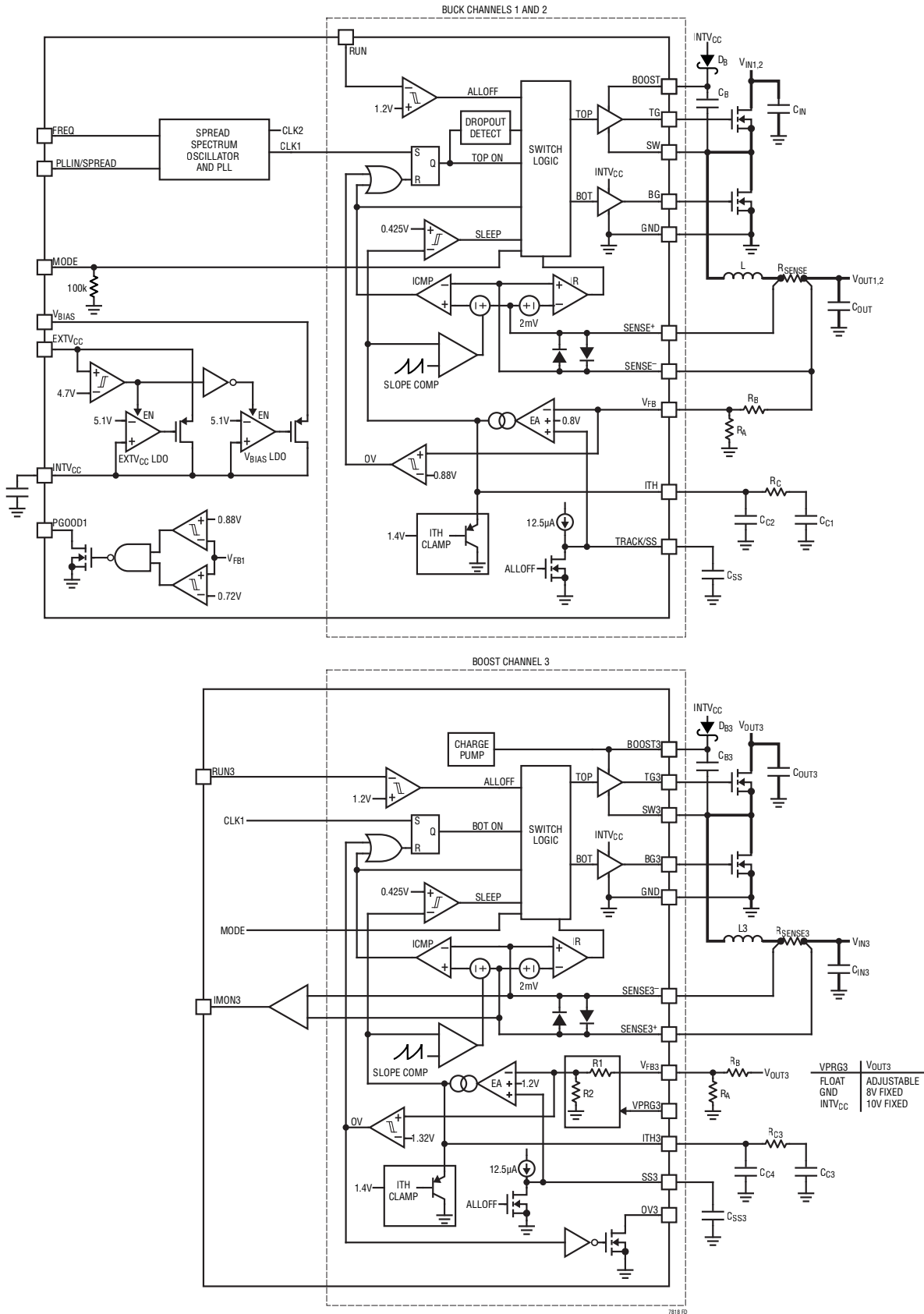

## OPERATION (Refer to Functional Diagram)

### Main Control Loop

The LTC7818 is a synchronous three-channel controller utilizing a constant-frequency, peak current mode architecture. The two step-down (buck) controllers, channels 1 and 2, operate 180° out-of-phase with each other. The step-up (boost) controller, channel 3, operates in phase with channel 1. During normal operation, the main switch (external top MOSFET for the buck channels or the external bottom MOSFET for the boost channel) is turned on when the clock for that channel sets the SR latch, causing the inductor current to increase. The main switch is turned off when the main current comparator, ICMP, resets the SR latch. After the main switch is turned off each cycle, the synchronous switch (the bottom MOSFET for the buck channels or the top MOSFET for the boost channel) is turned on which causes the inductor current to decrease until either the inductor current starts to reverse, as indicated by the current comparator IR, or the beginning of the next clock cycle.

The peak inductor current at which ICMP trips and resets the latch is controlled by the voltage on the ITH pin, which is the output of the error amplifier EA. The error amplifier compares the output voltage feedback signal at the V<sub>FB</sub> pin, (which is generated with an external resistor divider connected across the output voltage, V<sub>OUT</sub>, to ground) to the internal reference voltage (0.8V for the bucks or 1.2V for the boost). When the load current increases, it causes a slight decrease in V<sub>FB</sub> relative to the reference, which causes the EA to increase the ITH voltage until the average inductor current matches the new load current.

### Power and Bias Supplies (V<sub>BIAS</sub>, EXT<sub>VCC</sub>, and INT<sub>VCC</sub>)

The INT<sub>VCC</sub> pin supplies power for the top and bottom MOSFET drivers and most of the internal circuitry. LDOs (low dropout linear regulators) are available from both the V<sub>BIAS</sub> and EXT<sub>VCC</sub> pins to provide power to INT<sub>VCC</sub>, which has a regulation point of 5.1V. When the EXT<sub>VCC</sub> pin is left open or tied to a voltage less than 4.7V, the V<sub>BIAS</sub> LDO (low dropout linear regulator) supplies power to INT<sub>VCC</sub>. If EXT<sub>VCC</sub> is taken above 4.7V, the V<sub>BIAS</sub> LDO is turned off and an EXT<sub>VCC</sub> LDO is turned on. Once enabled, the EXT<sub>VCC</sub> LDO supplies power to INT<sub>VCC</sub>. Using the EXT<sub>VCC</sub>

pin allows the INT<sub>VCC</sub> power to be derived from a high efficiency external source such as one of the LTC7818 switching regulator outputs.

Each top MOSFET driver is biased from the floating bootstrap capacitor C<sub>B</sub>, which normally recharges during each cycle through an external diode when the switch voltage goes low.

For buck channels 1 and 2, if the buck's input voltage decreases to a voltage close to its output, the loop may enter dropout and attempt to turn on the top MOSFET continuously. The dropout detector detects this and forces the top MOSFET off for a short time every tenth cycle to allow C<sub>B</sub> to recharge, resulting in a 99% duty cycle at 380kHz operation and approximately 98% duty cycle at 2MHz operation.

### Shutdown and Start-Up (RUN1, RUN2, RUN3 and TRACK/SS1, TRACK/SS2, SS3 Pins)

The three channels of the LTC7818 can be independently shut down using the RUN1, RUN2 and RUN3 pins. Pulling a RUN pin below 1.1V shuts down the main control loop for that channel. Pulling all three pins below 0.7V disables all controllers and most internal circuits, including the INT<sub>VCC</sub> LDOs. In this state, the LTC7818 draws only 1.5μA of quiescent current.

The RUN pins may be externally pulled up or driven directly by logic. Each pin can tolerate up to 40V (absolute maximum), so it can be conveniently tied to V<sub>BIAS</sub> or to an input supply in always-on applications where one or more controllers are enabled continuously and never shut down. Additionally, a resistive divider from the input supply to a RUN pin can be used to set a precise input undervoltage lockout so that the power supply does not operate below a user-adjustable level.

The start-up of each channel's output voltage V<sub>OUT</sub> is controlled by the voltage on the TRACK/SS pin (TRACK/SS1 for channel 1, TRACK/SS2 for channel 2, SS3 for channel 3). When the voltage on the TRACK/SS pin is less than the internal reference voltage (0.8V for the bucks or 1.2V for the boost), the LTC7818 regulates the V<sub>FB</sub> voltage to the TRACK/SS pin voltage instead of the corresponding reference voltage. This allows the TRACK/SS

## OPERATION

pin to be used as a soft-start which smoothly ramps the output voltage on startup, thereby limiting the input supply inrush current. An external capacitor from the TRACK/SS pin to GND is charged by an internal 12.5 $\mu$ A pull-up current, creating a voltage ramp on the TRACK/SS pin. As the TRACK/SS voltage rises linearly from 0V to 0.8V/1.2V (and beyond), the output voltage  $V_{OUT}$  rises smoothly from zero to its final value.

Alternatively, the TRACK/SS pins for buck channels 1 and 2 can be used to make the start-up of  $V_{OUT}$  track that of another supply. Typically this requires connecting to the TRACK/SS pin through an external resistor divider from the other supply to ground (see the Applications Information section).

### Light Load Operation: Burst Mode Operation, Pulse-Skipping, or Forced Continuous Mode (MODE Pin)

The LTC7818 can be set to enter high efficiency Burst Mode operation, constant-frequency pulse-skipping mode or forced continuous conduction mode at low load currents.

To select Burst Mode operation, tie the MODE pin to ground. To select forced continuous operation, tie the MODE pin to  $INTV_{CC}$ . To select pulse-skipping mode, tie the MODE pin to a DC voltage greater than 1.2V and less than  $INTV_{CC} - 1.3V$ . An internal 100k resistor to ground invokes Burst Mode operation when the MODE pin is floating and pulse-skipping mode when the MODE pin is tied to  $INTV_{CC}$  through an external 100k resistor.

When the controllers are enabled for Burst Mode operation, the minimum peak current in the inductor is set to approximately 25% of its maximum value even though the voltage on the ITH pin might indicate a lower value. If the average inductor current is higher than the load current, the error amplifier EA will decrease the voltage on the ITH pin. When the ITH voltage drops below 0.425V, the internal sleep signal goes high (enabling sleep mode) and both external MOSFETs are turned off. The ITH pin is then disconnected from the output of the EA and parked at 0.45V.

In sleep mode, much of the internal circuitry is turned off, reducing the quiescent current that the LTC7818 draws. If one channel is in sleep mode and the other two are shut down, the LTC7818 draws only 15 $\mu$ A of quiescent current. If all three channels are in sleep mode, the LTC7818 draws only 18 $\mu$ A of quiescent current. When  $V_{OUT}$  on channel 1 is 3.2V or higher, the majority of this quiescent current is supplied by the SENSE1 $^-$  pin, which further reduces the input-referred quiescent current by the ratio of  $V_{IN}/V_{OUT}$  multiplied by the efficiency.

In sleep mode, the load current is supplied by the output capacitor. As the output voltage decreases, the EA's output begins to rise. When the output voltage drops enough, the ITH pin is reconnected to the output of the EA, the sleep signal goes low, and the controller resumes normal operation by turning on the main switch on the next cycle of the internal oscillator.

When a controller is enabled for Burst Mode operation, the inductor current is not allowed to reverse. The reverse current comparator (IR) turns off the synchronous switch just before the inductor current reaches zero, preventing it from reversing and going negative. Thus, the controller operates in discontinuous operation.

In forced continuous operation the inductor current is allowed to reverse at light loads or under large transient conditions. The peak inductor current is determined by the voltage on the ITH pin, just as in normal operation. In this mode, the efficiency at light loads is lower than in Burst Mode operation. However, continuous operation has the advantage of lower output voltage ripple and less interference to audio circuitry. In forced continuous mode, the output ripple is independent of load current.

When the MODE pin is connected for pulse-skipping mode, the LTC7818 operates in PWM pulse-skipping mode at light loads. In this mode, constant-frequency operation is maintained down to approximately 1% of designed maximum output current. At very light loads, the current comparator ICMP may remain tripped for several cycles and force the main switch to stay off for the same

## OPERATION

number of cycles (i.e., skipping pulses). The inductor current is not allowed to reverse (discontinuous operation). This mode, like forced continuous operation, exhibits low output ripple as well as low audio noise and reduced RF interference as compared to Burst Mode operation. It provides higher low current efficiency than forced continuous mode, but not nearly as high as Burst Mode operation.

Unlike forced continuous mode and pulse-skipping mode, Burst Mode operation cannot be synchronized to an external clock. Therefore, if Burst Mode operation is selected and the switching frequency is synchronized to an external clock applied to the PLLIN/SPREAD pin, the LTC7818 switches from Burst Mode operation to forced continuous mode.

### Frequency Selection, Spread Spectrum, and Phase-Locked Loop (FREQ and PLLIN/SPREAD Pins)

The free running switching frequency of the LTC7818 controllers is selected using the FREQ pin. Tying FREQ to GND selects 380kHz while tying FREQ to INTV<sub>CC</sub> selects 2.25MHz. Placing a resistor between FREQ and GND allows the frequency to be programmed between 100kHz and 3MHz.

Switching regulators can be particularly troublesome for applications where electromagnetic interference (EMI) is a concern. To improve EMI, the LTC7818 can operate in spread spectrum mode, which is enabled by tying the PLLIN/SPREAD pin to INTV<sub>CC</sub>. This feature varies the switching frequency within typical boundaries of -12% to ±15% of the frequency set by the FREQ pin.

A phase-locked loop (PLL) is available on the LTC7818 to synchronize the internal oscillator to an external clock source connected to the PLLIN/SPREAD pin. The LTC7818's PLL aligns the turn-on of controller 1's external top MOSFET to the rising edge of the synchronizing signal. Thus, the turn-on of controller 2's external top MOSFET is 180° out-of-phase to the rising edge of the external clock source.

The PLL frequency is prebiased to the free running frequency set by the FREQ pin before the external clock is applied. If prebiased near the external clock frequency, the PLL only needs to make slight changes in order to synchronize the rising edge of the external clock to the rising edge of TG1. For more rapid lock-in to the external clock, use the FREQ pin to set the internal oscillator to approximately the frequency of the external clock. The LTC7818's PLL is guaranteed to lock to an external clock source whose frequency is between 100kHz and 3MHz.

The PLLIN/SPREAD pin is TTL compatible with thresholds of 1.6V (rising) and 1.1V (falling) and is guaranteed to operate with a clock signal swing of 0.5V to 2.5V.

### Boost Controller Operation When $V_{IN} > V_{OUT}$

When the input voltage to the boost channel rises above its regulated  $V_{OUT}$  voltage, the controller can behave differently depending on the mode, inductor current and  $V_{IN}$  voltage. When  $V_{IN}$  exceeds the regulated  $V_{OUT}$  in forced continuous mode, the loop works to keep the top MOSFET on continuously. An internal charge pump delivers current to the boost capacitor from the BOOST3 pin to maintain a sufficiently high TG3 voltage.

If  $V_{IN}$  is between 100% and 110% of the regulated  $V_{OUT}$  voltage and pulse-skipping mode is selected, TG3 turns on if the inductor current rises above approximately 4% of the programmed current limit. Similarly, if Burst Mode operation is selected, then TG3 turns on as long as at least one channel is awake. If both buck channels are asleep or shut down, TG3 remains off regardless of the inductor current.

If  $V_{IN}$  rises above 110% of the regulated  $V_{OUT}$  voltage in any mode, the controller turns on TG3 continuously regardless of the inductor current. In Burst Mode operation, however, the internal charge pump is disabled when none of the channels are awake. With the charge pump off, the boost capacitor may discharge, resulting in an insufficient TG3 voltage needed to keep the top MOSFET completely on.



## OPERATION

### Boost Controller at Low Input Voltage

The LTC7818 features a rail-to-rail current comparator for the boost channel which functions down to zero volts. The minimum boost converter input voltage is therefore determined by the practical limitations of the boost converter architecture. Since the input voltage could be lower than the 4.5V  $V_{BIAS}$  limit,  $V_{BIAS}$  can be connected to the output of the boost controller, as illustrated in the typical application circuit in Figure 10. This allows the boost controller to handle very low input voltage transients while maintaining output voltage regulation.

### Buck Controller Output Overvoltage Protection

The two buck channels have an overvoltage comparator that guards against transient overshoots as well as other more serious conditions that may overvoltage their outputs. When the  $V_{FB1,2}$  pin rises more than 10% above its regulation point of 0.8V, the top MOSFET is turned off and the bottom MOSFET is turned on until the overvoltage condition is cleared.

### Buck Foldback Current

When the buck output voltage falls to less than 50% of its nominal level, foldback current limiting is activated, progressively lowering the peak current limit in proportion to the severity of the overcurrent or short-circuit condition. Foldback current limiting is disabled during the soft-start interval (as long as the  $V_{FB}$  voltage is keeping up with the TRACK/SS1,2 voltage). There is no foldback current limiting for the boost channel.

### Channel 1 Power Good (PGOOD1)

Channel 1 has a PGOOD1 pin that is connected to an open drain of an internal N-channel MOSFET. The MOSFET turns on and pulls the PGOOD1 pin low when the  $V_{FB1}$  pin voltage is not within  $\pm 10\%$  of the 0.8V reference. The PGOOD1 pin is also pulled low when the RUN1 pin is low (shut down). When the  $V_{FB1}$  pin voltage is within the  $\pm 10\%$  requirement, the MOSFET is turned off and the pin is allowed to be pulled up by an external resistor to a source no greater than 6V, such as  $INTV_{CC}$ .

### Boost Overvoltage Indicator (OV3)

The OV3 pin is an overvoltage indicator that signals whether the output voltage of the channel 3 boost controller exceeds its programmed regulated voltage. The OV3 pin is connected to an open drain of an internal N-channel MOSFET. The MOSFET turns on and pulls the OV3 pin low when the  $V_{FB3}$  pin voltage is less than 110% of the regulation point. The OV3 pin is also pulled low when the RUN3 pin is low (shut down). When the  $V_{FB3}$  pin voltage is greater than 110% of the regulation point, the MOSFET is turned off and the pin is allowed to be pulled up by an external resistor to a source no greater than 6V, such as  $INTV_{CC}$ .

## APPLICATIONS INFORMATION

The Typical Application on the first page is a basic LTC7818 application circuit. External component selection is largely driven by the load requirement and begins with the selection of the inductor, current sense components, operating frequency, and light load operating mode. The remaining power stage components, consisting of the input and output capacitors, and power MOSFETs can then be chosen. Next, feedback resistors are selected to set the desired output voltage. Then, the remaining external components are selected, such as for soft-start, biasing, and loop compensation.

### Inductor Value Calculation

The operating frequency and inductor selection are interrelated in that higher operating frequencies allow the use of smaller inductor and capacitor values. So why would anyone ever choose to operate at lower frequencies with larger components? The answer is efficiency. A higher frequency generally results in lower efficiency because of MOSFET switching and gate charge losses. In addition to this basic trade-off, the effect of inductor value on ripple current and low current operation must also be considered. The inductor value has a direct effect on ripple current.

For a buck regulator, the maximum average inductor current  $I_{L(MAX)}$  is equal to the maximum output current. The peak current is equal to the average inductor current plus half of the inductor ripple current,  $\Delta I_L$ , which for a buck regulator decreases with higher inductance or higher frequency and increases with higher  $V_{IN}$  as given by Equation 1.

$$\Delta I_L = \frac{1}{(f)(L)} V_{OUT} \left( 1 - \frac{V_{OUT}}{V_{IN}} \right) \quad (1)$$

For a boost regulator, the maximum average output current in continuous conduction mode is equal to the maximum average inductor current multiplied by a factor of  $V_{IN}/V_{OUT}$ , or  $I_{OUT(MAX)} = I_{L(MAX)} \cdot V_{IN}/V_{OUT}$ . Be aware that the maximum output current from a boost regulator decreases with decreasing  $V_{IN}$ . The choice of  $I_{L(MAX)}$  therefore depends on the maximum load current for a regulated  $V_{OUT}$  at the minimum normal operating  $V_{IN}$ . If the load current limit for a given  $V_{IN}$  is exceeded,  $V_{OUT}$  will decrease until the  $I_{OUT(MAX)} = I_{L(MAX)} \cdot V_{IN}/V_{OUT}$  equation

is satisfied. Additionally, when the output is in overvoltage ( $V_{IN} > V_{OUT}$ ), the top switch is on continuously and the maximum load current is equal to  $I_{L(MAX)}$ . The inductor ripple current  $\Delta I_L$  for a boost regulator increases with higher  $V_{OUT}$  as given by Equation 2.

$$\Delta I_L = \frac{1}{(f)(L)} V_{IN} \left( 1 - \frac{V_{IN}}{V_{OUT}} \right) \quad (2)$$

Accepting larger values of  $\Delta I_L$  allows the use of low inductances, but results in higher output voltage ripple and greater core losses. A reasonable starting point for setting ripple current is  $\Delta I_L = 0.3 \cdot I_{L(MAX)}$ . The maximum  $\Delta I_L$  occurs at the maximum input voltage for a buck and at  $V_{IN} = V_{OUT}/2$  for a boost.

The inductor value also has secondary effects. The transition to Burst Mode operation begins when the average inductor current required results in a peak current below 25% of the current limit determined by  $R_{SENSE}$ . Lower inductor values (higher  $\Delta I_L$ ) will cause this to occur at lower load currents, which can cause a dip in efficiency in the upper range of low current operation.

### Inductor Core Selection

Once the value for L is known, the type of inductor must be selected. High efficiency regulators generally cannot afford the core loss found in low cost powdered iron cores, forcing the use of more expensive ferrite or molypermalloy cores. Actual core loss is very dependent on inductance value selected. As inductance increases, core losses go down. Unfortunately, increased inductance requires more turns of wire and therefore copper losses will increase.

Ferrite designs have very low core loss and are preferred for high switching frequencies, so design goals can concentrate on copper loss and preventing saturation. Ferrite core material saturates hard, which means that inductance collapses abruptly when the peak design current is exceeded. This results in an abrupt increase in inductor ripple current and consequent output voltage ripple. Do not allow the core to saturate!

## APPLICATIONS INFORMATION

### Current Sense Selection

The LTC7818 can be configured to use either DCR (inductor resistance) sensing or low value resistor sensing. The choice between the two current sensing schemes is largely a design trade-off between cost, power consumption and accuracy. DCR sensing has become popular because it saves expensive current sensing resistors and is more power efficient, particularly in higher current and lower frequency applications. However, current sensing resistors provide the most accurate current limits for the controller. Other external component selection is driven by the load requirement, and begins with the selection of  $R_{SENSE}$  (if  $R_{SENSE}$  is used) and inductor value.

The SENSE<sup>+</sup> and SENSE<sup>-</sup> pins are the inputs to the current comparators. The common mode voltage range on these pins is 0V to 40V (absolute maximum), enabling the LTC7818 to regulate output voltages up to a maximum of 40V. The SENSE1<sup>+</sup>, SENSE2<sup>+</sup>, and SENSE3<sup>-</sup> pins are high impedance, drawing less than  $\approx 1\mu\text{A}$ . This high impedance allows the current comparators to be used in inductor DCR sensing. The impedance of the SENSE1<sup>-</sup>, SENSE2<sup>-</sup>, and SENSE3<sup>+</sup> pins changes depending on the common mode voltage. When less than  $\text{INTV}_{CC} - 0.5\text{V}$ , these pins are relatively high impedance, drawing  $\approx 1\mu\text{A}$ . When above  $\text{INTV}_{CC} + 0.5\text{V}$ , a higher current ( $\approx 620\mu\text{A}$ ) flows into each pin. Between  $\text{INTV}_{CC} - 0.5\text{V}$  and  $\text{INTV}_{CC} + 0.5\text{V}$ , the current transitions from the smaller current to the higher current. Channel 1's SENSE1<sup>-</sup> pin has an additional  $\approx 40\mu\text{A}$  current when its voltage is above 3.2V to bias internal circuitry from  $V_{OUT1}$ , thereby reducing the input-referred supply current.

Filter components mutual to the sense lines should be placed close to the LTC7818, and the sense lines should

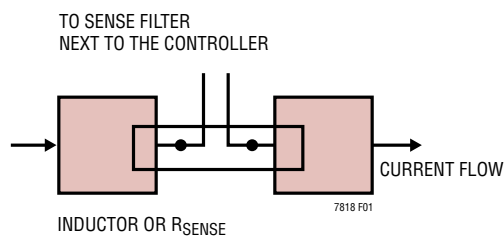

Figure 1. Sense Lines Placement with Inductor or Sense Resistor

run close together to a Kelvin connection underneath the current sense element (shown in Figure 1). Sensing current elsewhere can effectively add parasitic inductance and capacitance to the current sense element, degrading the information at the sense terminals and making the programmed current limit unpredictable. If DCR sensing is used (Figure 2b), resistor R1 should be placed close to the switching node, to prevent noise from coupling into sensitive small signal nodes.

### Low Value Resistor Current Sensing

A typical sensing circuit using a discrete resistor is shown in Figure 2a.  $R_{SENSE}$  is chosen based on the required output current. Each controller's current comparator has a maximum threshold  $V_{SENSE(MAX)}$  of 50mV. The current comparator threshold voltage sets the peak inductor current.

Using the maximum inductor current ( $I_{L(MAX)}$ ) and ripple current ( $\Delta I_L$ ) from the Inductor Value Calculation section, the target sense resistor value is given by Equation 3.

$$R_{SENSE} \leq \frac{V_{SENSE(MAX)}}{I_{L(MAX)} + \frac{\Delta I_L}{2}} \quad (3)$$

To ensure that the application will deliver full load current over the full operating temperature range, choose the minimum value for  $V_{SENSE(MAX)}$  in the Electrical Characteristics table.

To avoid potential jitter or instability due to PCB noise coupling into the current sense signal, the AC current sensing ripple of  $\Delta V_{SENSE} = \Delta I_L \cdot R_{SENSE}$  should also be checked to ensure a good signal-to-noise ratio. In general, for a reasonably good PCB layout, a target  $\Delta V_{SENSE}$  voltage of 10mV to 20mV at nominal input voltage for the bucks and at 50% duty cycle for the boost is recommended for both  $R_{SENSE}$  and DCR sensing applications.

The parasitic inductance (ESL) of the sense resistor introduces significant error in the current sense signal for lower inductor value ( $< 3\mu\text{H}$ ) or higher current ( $> 5\text{A}$ ) applications. For a buck converter, this error is proportional to the input voltage and may degrade line regulation or cause loop instability. An RC filter into the sense pins, as shown in

## APPLICATIONS INFORMATION

Figure 2a, can be used to compensate for this error. Set the RC filter time constant  $R_F \cdot C_F = ESL/R_{SENSE}$  for optimal cancellation of the ESL. In general, select  $C_F$  to be in the range of 1nF to 10nF and calculate the corresponding  $R_F$ . Surface mount sense resistors in low ESL wide footprint geometries are recommended to minimize this error. If not specified on the manufacturer's data sheet, the ESL can be approximated as 0.4nH for a resistor with a 1206 footprint and 0.2nH for a 1225 footprint.

### Inductor DCR Current Sensing

For applications requiring the highest possible efficiency at high load currents, the LTC7818 is capable of sensing the voltage drop across the inductor DCR, as shown in Figure 2b. The DCR of the inductor represents the small amount of DC winding resistance of the copper, which can be less than 1mΩ for today's low value, high current inductors. In a high current application requiring such an inductor, power loss through a sense resistor would cost several points of efficiency compared to inductor DCR sensing.

If the external  $(R1||R2) \cdot C1$  time constant is chosen to be exactly equal to the  $L/DCR$  time constant, the voltage drop across the external capacitor is equal to the drop across the inductor DCR multiplied by  $R2/(R1+R2)$ .  $R2$  scales the voltage across the sense terminals for applications where the DCR is greater than the target sense resistor value. To properly dimension the external filter components, the DCR of the inductor must be known. It can be measured using a good RLC meter, but the DCR tolerance is not always the same and varies with temperature; consult the manufacturers' data sheets for detailed information.

Using the maximum inductor current ( $I_{L(MAX)}$ ) and ripple current ( $\Delta I_L$ ) from the Inductor Value Calculation section, the target sense resistor value is given by Equation 4.

$$R_{SENSE(EQUIV)} \leq \frac{V_{SENSE(MAX)}}{I_{L(MAX)} + \frac{\Delta I_L}{2}} \quad (4)$$

To ensure that the application will deliver full load current over the full operating temperature range, choose the minimum value for  $V_{SENSE(MAX)}$  in the Electrical Characteristics table.

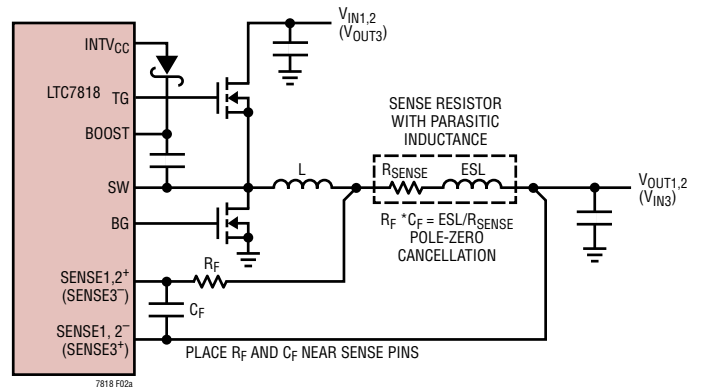

(2a) Using a Resistor to Sense Current

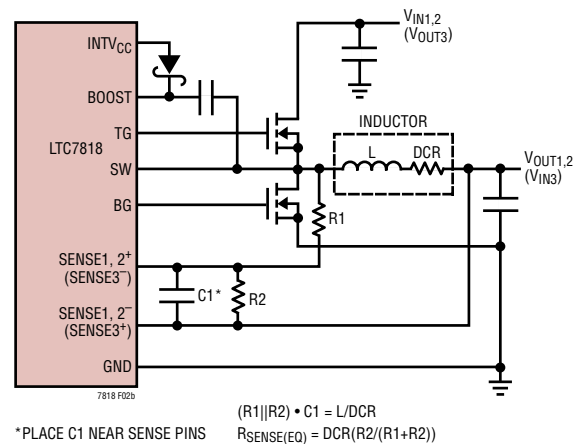

(2b) Using the Inductor DCR to Sense Current

### Figure 2. Current Sensing Methods

Next, determine the DCR of the inductor. When provided, use the manufacturer's maximum value, usually given at 20°C. Increase this value to account for the temperature coefficient of copper resistance, which is approximately 0.4%/°C. A conservative value for  $T_{L(MAX)}$  is 100°C. To scale the maximum inductor DCR to the desired sense resistor value, use the divider ratio given by Equation 5.

$$R_D = \frac{R_{SENSE(EQUIV)}}{DCR_{MAX} \text{ at } T_{L(MAX)}} \quad (5)$$

$C1$  is usually selected to be in the range of 0.1μF to 0.47μF. This forces  $R1||R2$  to around 2k, reducing error that might have been caused by the SENSE+ pin's  $\approx 1\mu A$  current.

## APPLICATIONS INFORMATION

The target equivalent resistance  $R1||R2$  is calculated from the nominal inductance,  $C1$  value, and DCR (Equation 6).

$$R1||R2 = \frac{L}{(\text{DCR at } 20^{\circ}\text{C}) \cdot C1} \quad (6)$$

The sense resistor values are given by Equation 7.

$$R1 = \frac{R1||R2}{R_D}; \quad R2 = \frac{R1 \cdot R_D}{1 - R_D} \quad (7)$$

The maximum power loss in  $R1$  is related to duty cycle. For the buck controllers, the maximum power loss occurs in continuous mode at the maximum input voltage (Equation 8).

$$P_{\text{Loss } R1} = \frac{(V_{\text{IN}(\text{MAX})} - V_{\text{OUT}}) \cdot V_{\text{OUT}}}{R1} \quad (8)$$

For the boost controller, the maximum power loss occurs in continuous mode at  $V_{\text{IN}} = V_{\text{OUT}}/2$  (Equation 9).

$$P_{\text{Loss } R1} = \frac{(V_{\text{OUT}(\text{MAX})} - V_{\text{IN}}) \cdot V_{\text{IN}}}{R1} \quad (9)$$

Ensure that  $R1$  has a power rating higher than this value. If high efficiency is necessary at light loads, consider this power loss when deciding whether to use DCR sensing or sense resistors. Light load power loss can be modestly higher with a DCR network than with a sense resistor, due to the extra switching losses incurred through  $R1$ . However, DCR sensing eliminates a sense resistor, reduces conduction losses and provides higher efficiency at heavy loads. Peak efficiency is about the same with either method.

### Setting the Operating Frequency

Selection of the operating frequency is a trade-off between efficiency and component size. High frequency operation allows the use of smaller inductor and capacitor values. Operation at lower frequencies improves efficiency by reducing gate charge and transition losses, but requires larger inductance values and/or more output capacitance to maintain low output ripple voltage.

In higher voltage applications transition losses contribute more significantly to power loss, and a good balance between size and efficiency is generally achieved with a switching frequency between 300kHz and 900kHz. Lower voltage applications benefit from lower switching losses

and can therefore more readily operate at higher switching frequencies up to 3MHz if desired.

A further constraint on the operating frequency is due to the maximum duty cycle of the boost channel. The maximum duty cycle, which can be approximated as  $DC_{\text{MAX}} \approx (1 - V_{\text{IN}(\text{MIN})}/V_{\text{OUT}3}) \cdot 100\%$ , is limited as shown in Figure 3a. At low frequencies, the output will dropout if the required duty cycle is higher than 93%. At high frequencies, the maximum duty cycle available to maintain constant-frequency operation is reduced further. In this region, if a higher duty cycle is required to keep the output voltage in regulation, the controller will skip the top MOSFET (TG3) turn-on and keep the bottom MOSFET (BG3) on for more than one clock cycle to achieve the

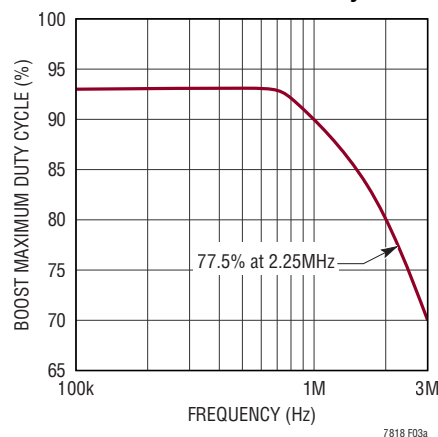

(3a) Relationship Between Oscillator Frequency and Boost Channel Maximum Duty Cycle

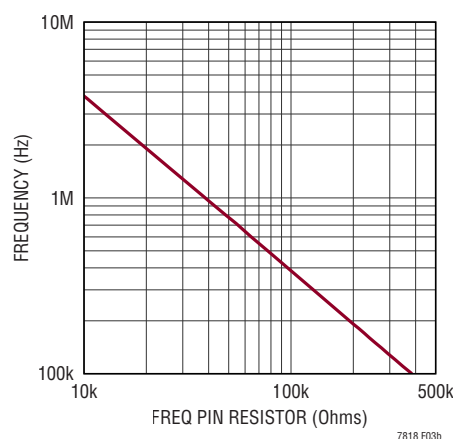

(3b) Relationship Between Oscillator Frequency and Resistor Value at the FREQ Pin

Figure 3. Setting the Operating Frequency

## APPLICATIONS INFORMATION

higher duty cycle at an effectively lower frequency. Choose a frequency that limits the maximum duty cycle to a value lower than the curve shown in Figure 3a. The switching frequency is set using the FREQ and PLLIN/SPREAD pins as shown in Table 1.

**Table 1.**

FREQ PIN	PLLIN/SPREAD PIN	FREQUENCY
0V	0V	380kHz
INTV <sub>CC</sub>	0V	2.25MHz
Resistor to GND	0V	100kHz to 3MHz
Any of the Above	External Clock 100kHz to 3MHz	Phase-Locked to External Clock
Any of the Above	INTV <sub>CC</sub>	Spread Spectrum Modulated

Tying the FREQ pin to ground selects 380kHz while tying FREQ to INTV<sub>CC</sub> selects 2.25MHz. Placing a resistor between FREQ and ground allows the frequency to be programmed anywhere between 100kHz and 3MHz. Choose a FREQ pin resistor from Figure 3b or Equation 10.

$$R_{\text{FREQ}}(\text{in k}\Omega) = \frac{37\text{MHz}}{f_{\text{OSC}}} \quad (10)$$

To improve electromagnetic interference (EMI) performance, spread spectrum mode can optionally be selected by tying the PLLIN/SPREAD pin to INTV<sub>CC</sub>. When spread spectrum is enabled, the switching frequency modulates -12% to +15% of the frequency selected by the FREQ pin. Spread spectrum may be used in any operating mode selected by the MODE pin (Burst Mode operation, pulse-skipping, or forced continuous mode).

A phase-locked loop (PLL) is also available on the LTC7818 to synchronize the internal oscillator to an external clock source connected to the PLLIN/SPREAD pin. After the PLL locks, TG1 is synchronized to the rising edge of the external clock signal, and TG2 is 180° out-of-phase from TG1. See the Phase-Locked Loop and Frequency Synchronization section for details.

### Selecting the Light Load Operating Mode

The LTC7818 can be set to enter high efficiency Burst Mode operation, constant-frequency pulse-skipping mode or forced continuous conduction mode at light load currents. To select Burst Mode operation, tie the MODE to

ground. To select forced continuous operation, tie the MODE pin to INTV<sub>CC</sub>. To select pulse-skipping mode, tie the MODE pin to INTV<sub>CC</sub> through a 100k resistor. An internal 100k resistor from the MODE pin to ground selects Burst Mode operation if the pin is floating. When synchronized to an external clock through the PLLIN/SPREAD pin, the LTC7818 operates in pulse skipping mode if it is selected, or in forced continuous mode otherwise. Table 2 summarizes the use of the MODE pin to select the light load operating mode.

**Table 2.**

MODE PIN	LIGHT LOAD OPERATING MODE	MODE WHEN SYNCHRONIZED
0V or Floating	Burst Mode	Forced Continuous
100k to INTV <sub>CC</sub>	Pulse-Skipping	Pulse-Skipping
INTV <sub>CC</sub>	Forced Continuous	Forced Continuous

In general, the requirements of each application will dictate the appropriate choice for light load operating mode. In Burst Mode operation, the inductor current is not allowed to reverse. The reverse current comparator turns off the bottom MOSFET just before the inductor current reaches zero, preventing it from reversing and going negative. Thus, the regulator operates in discontinuous operation. In addition, when the load current is very light, the inductor current will begin bursting at frequencies lower than the switching frequency, and enter a low current sleep mode when not switching. As a result, Burst Mode operation has the highest possible efficiency at light load.

In forced continuous mode, the inductor current is allowed to reverse at light loads and switches at the same frequency regardless of load. In this mode, the efficiency at light loads is considerably lower than in Burst Mode operation. However, continuous operation has the advantage of lower output voltage ripple and less interference to audio circuitry. In forced continuous mode, the output ripple is independent of load current.

In pulse-skipping mode, constant-frequency operation is maintained down to approximately 1% of designed maximum output current. At very light loads, the PWM comparator may remain tripped for several cycles and force the top MOSFET to stay off for the same number of

## APPLICATIONS INFORMATION

cycles (i.e., skipping pulses). The inductor current is not allowed to reverse (discontinuous operation). This mode, like forced continuous operation, exhibits low output ripple as well as low audio noise and reduced RF interference as compared to Burst Mode operation. It provides higher light load efficiency than forced continuous mode, but not nearly as high as Burst Mode operation. Consequently, pulse-skipping mode represents a compromise between light load efficiency, output ripple and EMI.

In some applications, it may be desirable to change light load operating mode based on the conditions present in the system. For example, if a system is inactive, one might select high efficiency Burst Mode operation by keeping the MODE pin set to 0V. When the system wakes, one might send an external clock to PLLIN/SPREAD, or tie MODE to INTV<sub>CC</sub> to switch to low noise forced continuous mode. Such on-the-fly mode changes can allow an individual application to benefit from the advantages of each light load operating mode.

### Power MOSFET Selection

Two external power MOSFETs must be selected for each controller in the LTC7818: one N-channel MOSFET for the top switch (main switch for the buck, synchronous for the boost), and one N-channel MOSFET for the bottom switch (main switch for the boost, synchronous for the buck).

The peak-to-peak gate drive levels are set by the INTV<sub>CC</sub> regulation point of 5.1V. Consequently, logic level threshold MOSFETs must be used in most applications. Pay close attention to the BV<sub>DSS</sub> specification for the MOSFETs as well; many of the logic level MOSFETs are limited to 30V or less.

Selection criteria for the power MOSFETs include the on resistance R<sub>DS(ON)</sub>, Miller capacitance C<sub>MILLER</sub>, input voltage and maximum output current. Miller capacitance, C<sub>MILLER</sub>, can be approximated from the gate charge curve usually provided on the MOSFET manufacturers' data sheet. C<sub>MILLER</sub> is equal to the increase in gate charge along the horizontal axis while the curve is approximately flat divided by the specified change in V<sub>DS</sub>. This result is

then multiplied by the ratio of the application applied V<sub>DS</sub> to the gate charge curve specified V<sub>DS</sub>. When the IC is operating in continuous mode the duty cycles for the top and bottom MOSFETs are given by Equation 11.

$$\begin{aligned} \text{Buck Main Switch Duty Cycle} &= \frac{V_{OUT}}{V_{IN}} \\ \text{Buck Sync Switch Duty Cycle} &= \frac{V_{IN} - V_{OUT}}{V_{IN}} \\ \text{Boost Main Switch Duty Cycle} &= \frac{V_{OUT} - V_{IN}}{V_{OUT}} \\ \text{Boost Sync Switch Duty Cycle} &= \frac{V_{IN}}{V_{OUT}} \end{aligned} \quad (11)$$

For a buck converter, the MOSFET power dissipations at maximum output current are given by Equation 12.

$$\begin{aligned} P_{\text{MAIN\_BUCK}} &= \frac{V_{OUT}}{V_{IN}} (I_{OUT(\text{MAX})})^2 (1 + \delta) R_{DS(\text{ON})} + \\ & (V_{IN})^2 \left( \frac{I_{OUT(\text{MAX})}}{2} \right) (R_{DR}) (C_{\text{MILLER}}) \cdot \end{aligned} \quad (12)$$

$$\begin{aligned} & \left[ \frac{1}{V_{\text{INTVCC}} - V_{\text{THMIN}}} + \frac{1}{V_{\text{THMIN}}} \right] (f) \\ P_{\text{SYNC\_BUCK}} &= \frac{V_{IN} - V_{OUT}}{V_{IN}} (I_{OUT(\text{MAX})})^2 (1 + \delta) R_{DS(\text{ON})} \end{aligned}$$

Similarly, for a boost converter (Equation 13).

$$\begin{aligned} P_{\text{MAIN\_BOOST}} &= \frac{(V_{OUT} - V_{IN}) V_{OUT}}{V_{IN}^2} (I_{OUT(\text{MAX})})^2 \cdot \\ & (1 + \delta) R_{DS(\text{ON})} + \left( \frac{V_{OUT}^3}{V_{IN}} \right) \left( \frac{I_{OUT(\text{MAX})}}{2} \right) \cdot \\ & (R_{DR}) (C_{\text{MILLER}}) \cdot \left[ \frac{1}{V_{\text{INTVCC}} - V_{\text{THMIN}}} + \frac{1}{V_{\text{THMIN}}} \right] (f) \\ P_{\text{SYNC\_BOOST}} &= \frac{V_{OUT}}{V_{IN}} (I_{OUT(\text{MAX})})^2 (1 + \delta) R_{DS(\text{ON})} \end{aligned} \quad (13)$$

where  $\delta$  is the temperature dependency of R<sub>DS(ON)</sub> ( $\delta \approx 0.005/^\circ\text{C}$ ) and R<sub>DR</sub> is the effective driver resistance at the MOSFET's Miller threshold voltage (R<sub>DR</sub>  $\approx$  2 $\Omega$ ). V<sub>THMIN</sub> is the typical MOSFET minimum threshold voltage.

## APPLICATIONS INFORMATION

Both MOSFETs have  $I^2R$  losses while the main N-channel equations for the buck and boost controllers include an additional term for transition losses, which are highest at high input voltages for the bucks and high output voltages for the boost. For  $V_{IN} < 20V$  for the bucks (or  $V_{OUT} < 20V$  for the boost) the high current efficiency generally improves with larger MOSFETs, while for  $V_{IN} > 20V$  for the bucks ( $V_{OUT} > 20V$  for the boost) the transition losses rapidly increase to the point that the use of a higher  $R_{DS(ON)}$  device with lower  $C_{MILLER}$  actually provides higher efficiency. The synchronous MOSFET losses for the buck controllers are greatest at high input voltage when the top switch duty factor is low or during a short-circuit when the synchronous switch is on close to 100% of the period.

### Boost $C_{IN}$ and $C_{OUT}$ Selection

The input ripple current in a boost converter is relatively low (compared to the output ripple current) because this current is continuous. The boost input capacitor  $C_{IN}$  voltage rating should comfortably exceed the maximum input voltage. Although ceramic capacitors can be relatively tolerant of overvoltage conditions, aluminum electrolytic capacitors are not. Be sure to characterize the input voltage for any possible overvoltage transients that could apply excess stress to the input capacitors.

The value of  $C_{IN}$  is a function of the source impedance, and in general, the higher the source impedance, the higher the required input capacitance. The required amount of input capacitance is also greatly affected by the duty cycle. High output current applications that also experience high duty cycles can place great demands on the input supply, both in terms of DC current and ripple current.

The output current in a boost converter is discontinuous, so  $C_{OUT}$  should be selected to meet output voltage ripple requirements. The effects of ESR (equivalent series resistance) and the bulk capacitance must be considered when choosing the right capacitor for a given output ripple voltage. The ripple due to charging and discharging the bulk capacitance of  $C_{OUT}$  is given by Equation 14.

$$\text{Ripple} = \frac{I_{OUT(MAX)} \cdot (V_{OUT} - V_{IN(MIN)})}{C_{OUT} \cdot V_{OUT} \cdot f} V \quad (14)$$

The ripple due to the voltage drop across the ESR is given by Equation 15.

$$\Delta V_{ESR} = \left( I_{L(MAX)} + \frac{1}{2} \Delta I_L \right) \cdot ESR \quad (15)$$

Multiple capacitors placed in parallel may be needed to meet the ESR and RMS current handling requirements. Dry tantalum, special polymer, aluminum electrolytic and ceramic capacitors are all available in surface mount packages. Ceramic capacitors have excellent low ESR characteristics but can have a high voltage coefficient. Capacitors are now available with low ESR and high ripple current ratings such as OS-CON and POSCAP.

### Buck $C_{IN}$ and $C_{OUT}$ Selection

The selection of  $C_{IN}$  for the two buck controllers is simplified by the two-phase architecture and its impact on the worst-case RMS current drawn through the input network (battery/fuse/capacitor). It can be shown that the worst-case capacitor RMS current occurs when only one controller is operating. The controller with the highest  $V_{OUT} \cdot I_{OUT}$  product needs to be used in the formula shown in Equation 16 to determine the maximum RMS capacitor current requirement.

Increasing the output current drawn from the other controller will actually decrease the input RMS ripple current from its maximum value. The out-of-phase technique typically reduces the input capacitor's RMS ripple current by a factor of 30% to 70% when compared to a single phase power supply solution.

In continuous mode, the source current of the top MOSFET is a square wave of duty cycle  $V_{OUT}/V_{IN}$ . To prevent large voltage transients, a low ESR capacitor sized for the maximum RMS current of one channel must be used. At maximum load current  $I_{MAX}$ , the maximum RMS capacitor current is given by Equation 16.

$$C_{IN} \text{ Required } I_{RMS} \approx \frac{I_{MAX}}{V_{IN}} [(V_{OUT})(V_{IN} - V_{OUT})]^{1/2} \quad (16)$$

This formula has a maximum at  $V_{IN} = 2V_{OUT}$ , where  $I_{RMS} = I_{OUT}/2$ . This simple worst-case condition is commonly used for design because even significant deviations



## APPLICATIONS INFORMATION

do not offer much relief. Note that capacitor manufacturers' ripple current ratings are often based on only 2000 hours of life. This makes it advisable to further derate the capacitor, or to choose a capacitor rated at a higher temperature than required. Several capacitors may be paralleled to meet size or height requirements in the design. Due to the high operating frequency of the LTC7818, ceramic capacitors can also be used for  $C_{IN}$ . Always consult the manufacturer if there is any question.

The benefit of the LTC7818 two-phase operation can be calculated by using Equation 16 for the higher power controller and then calculating the loss that would have resulted if both controller channels switched on at the same time. The total RMS power lost is lower when both controllers are operating due to the reduced overlap of current pulses required through the input capacitor's ESR. This is why the input capacitor's requirement calculated above for the worst-case controller is adequate for the dual controller design. Also, the input protection fuse resistance, battery resistance, and PC board trace resistance losses are also reduced due to the reduced peak currents in a two-phase system. The overall benefit of a multiphase design will only be fully realized when the source impedance of the power supply/battery is included in the efficiency testing.

The drains of the top MOSFETs should be placed within 1cm of each other and share a common  $C_{IN}(s)$ . Separating the drains and  $C_{IN}$  may produce undesirable resonances at  $V_{IN}$ .

A small (0.1 $\mu$ F to 1 $\mu$ F) bypass capacitor between the chip  $V_{BIAS}$  pin and ground, placed close to the LTC7818, is also suggested. An optional 1 $\Omega$  to 10 $\Omega$  resistor placed between  $C_{IN}$  and the  $V_{BIAS}$  pin provides further isolation from a noisy input supply.

The selection of  $C_{OUT}$  is driven by the effective series resistance (ESR). Typically, once the ESR requirement is satisfied, the capacitance is adequate for filtering. The output ripple ( $\Delta V_{OUT}$ ) is approximated by Equation 17.

$$\Delta V_{OUT} \approx \Delta I_L \left( ESR + \frac{1}{8fC_{OUT}} \right) \quad (17)$$

where  $f$  is the operating frequency,  $C_{OUT}$  is the output capacitance and  $\Delta I_L$  is the ripple current in the inductor. The output ripple is highest at maximum input voltage since  $\Delta I_L$  increases with input voltage.

### Setting the Buck Output Voltage

The LTC7818 output voltages for the buck channels are each set by an external feedback resistor divider carefully placed across the output, as shown in Figure 4. The regulated output voltage is determined by Equation 18.

$$V_{OUT, BUCK} = 0.8V \left( 1 + \frac{R_B}{R_A} \right) \quad (18)$$

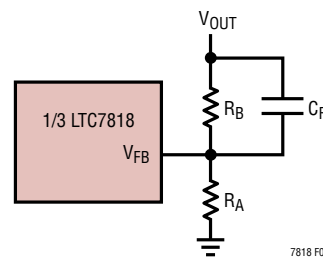

Figure 4. Setting Buck Output Voltage

Place resistors  $R_A$  and  $R_B$  very close to the  $V_{FB}$  pin to minimize PCB trace length and noise on the sensitive  $V_{FB}$  node. Great care should be taken to route the  $V_{FB}$  trace away from noise sources, such as the inductor or the SW trace. To improve frequency response, a feedforward capacitor ( $C_{FF}$ ) may be used.

For applications with multiple output voltage levels, select channel 1 to be the lowest output voltage that is greater than 3.2V. When the SENSE1<sup>-</sup> pin (connected to  $V_{OUT1}$ ) is above 3.2V, it biases some internal circuitry instead of  $V_{BIAS}$ , thereby increasing light load Burst Mode efficiency. Similarly, connect EXT $V_{CC}$  to the lowest output voltage that is greater than the 4.7V EXT $V_{CC}$  rising switch-over threshold. EXT $V_{CC}$  then supplies the high current gate drivers and relieves additional quiescent current from  $V_{BIAS}$ , further reducing the  $V_{BIAS}$  pin current to  $\approx 1\mu$ A in sleep.

## APPLICATIONS INFORMATION

### Setting Boost Output Voltage (VPRG3 Pin)

The VPRG3 pin selects whether the boost controller output voltage is set by an external feedback resistor divider or programmed to a fixed 8V or 10V output. Floating VPRG3 allows the boost output voltage to be set by an external feedback resistor divider as shown in Figure 5a. The regulated output voltage is then determined by Equation 19.

$$V_{OUT,BOOST} = 1.195V \left( 1 + \frac{R_B}{R_A} \right) \quad (19)$$

Tying the VPRG3 to GND or INTV<sub>CC</sub> configures the boost controller for a fixed output voltage of 8V or 10V, respectively. As shown in Figure 5b, directly connect V<sub>FB3</sub> to the output when configured for a fixed output voltage.

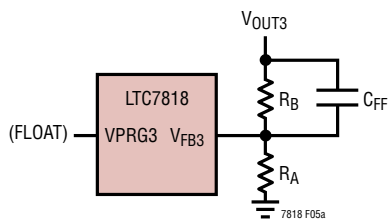

5a. Setting Boost Output Using External Resistors

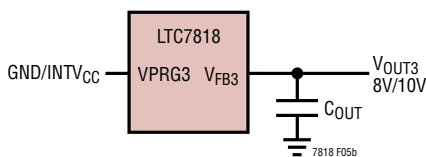

5b. Setting Boost to Fixed 8V/10V Output

Figure 5. Setting Boost Output Voltage

### RUN Pins and Undervoltage Lockout

The three channels of the LTC7818 are enabled using the RUN1, RUN2, and RUN3 pins. The RUN pins have a rising threshold of 1.2V with 100mV of hysteresis. Pulling a RUN pin below 1.1V shuts down the main control loop and resets the soft-start for that channel. Pulling all three RUN pins below 0.7V disables the controllers and most internal circuits, including the INTV<sub>CC</sub> LDOs. In this state, the LTC7818 draws only  $\approx 1.5\mu\text{A}$  of quiescent current.

The RUN pins are high impedance and must be externally pulled up/down or driven directly by logic. Each RUN pin can tolerate up to 40V (absolute maximum), so it can be conveniently tied to V<sub>BIAS</sub> in always-on applications where the controller is enabled continuously and never shut down. Do not float the RUN pins.

The RUN pins can also be configured as precise undervoltage lockouts (UVLOs) on a supply such as V<sub>BIAS</sub> or V<sub>OUT3</sub> with a resistor divider from the supply to ground. For example, a simple resistor divider can be used as shown in Figure 6 to satisfy a V<sub>BIAS</sub> UVLO requirement.

The V<sub>BIAS</sub> UVLO thresholds can be computed using Equation 20.

$$\begin{aligned} \text{UVLO Rising} &= 1.2V \left( 1 + \frac{R1}{R2} \right) \\ \text{UVLO Falling} &= 1.1V \left( 1 + \frac{R1}{R2} \right) \end{aligned} \quad (20)$$

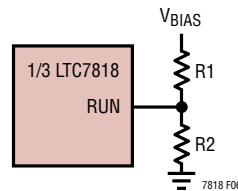

Figure 6. Using the RUN Pins as a UVLO

The current that flows through the R1-R2 divider directly adds to the shutdown, sleep, and active current of the LTC7818, and care should be taken to minimize the impact of this current on the overall efficiency of the application circuit. Resistor values in the M $\Omega$  range may be required to keep the impact on quiescent shutdown and sleep currents low.

### Soft-Start and Tracking (TRACK/SS1, TRACK/SS2, SS3 Pins)

The start-up of each V<sub>OUT</sub> is controlled by the voltage on the TRACK/SS pin (TRACK/SS1 for channel 1, TRACK/SS2 for channel 2, SS3 for channel 3). When the voltage on the TRACK/SS pin is less than the internal 0.8V reference (1.2V reference for the boost channel), the LTC7818 regulates the V<sub>FB</sub> pin voltage to the voltage on the TRACK/

## APPLICATIONS INFORMATION

SS pin instead of the internal reference. The TRACK/SS pin can be used to program an external soft-start function or to allow  $V_{OUT}$  to track another supply during start-up.

Soft-start is enabled by simply connecting a capacitor from the TRACK/SS pin to ground. An internal  $12.5\mu\text{A}$  current source charges the capacitor, providing a linear ramping voltage at the TRACK/SS pin. The LTC7818 will regulate its feedback voltage (and hence  $V_{OUT}$ ) according to the voltage on the TRACK/SS pin, allowing  $V_{OUT}$  to rise smoothly from  $0\text{V}$  to its final regulated value. For a desired soft-start time,  $t_{SS}$ , select a soft-start capacitor  $C_{SS} = t_{SS} \cdot 15\mu\text{F}/\text{sec}$  for the buck channels and  $C_{SS} = t_{SS} \cdot 10\mu\text{F}/\text{sec}$  for the boost channel.

Alternatively, the TRACK/SS1 and TRACK/SS2 pins can be used to track two or more supplies during start-up, as shown qualitatively in Figure 7a and Figure 7b. To do this, a resistor divider should be connected from the master supply ( $V_X$ ) to the TRACK/SS pin of the slave supply ( $V_{OUT}$ ), as shown in Figure 8. During start-up  $V_{OUT}$  will track  $V_X$  according to the ratio set by the resistor divider (Equation 21).

$$\frac{V_X}{V_{OUT}} = \frac{R_A}{R_{TRACKA}} \cdot \frac{R_{TRACKA} + R_{TRACKB}}{R_A + R_B} \quad (21)$$

Set  $R_{TRACKA} = R_A$  and  $R_{TRACKB} = R_B$  for coincident tracking ( $V_{OUT} = V_X$  during start-up).

### Single Output Two-Phase Operation

For high power applications, the two buck channels can be operated in a two-phase single output configuration. The buck channels switch  $180^\circ$  out-of-phase, which reduces the required output capacitance in addition to the required input capacitance and power supply induced noise. To configure the LTC7818 for two-phase operation, tie  $V_{FB2}$  to  $\text{INTV}_{CC}$ ,  $\text{ITH2}$  to ground, and  $\text{RUN2}$  to  $\text{RUN1}$ . The  $\text{RUN1}$ ,  $V_{FB1}$ ,  $\text{ITH1}$ , TRACK/SS1 pins are then used to control both buck channels, but each channel uses its own ICMP and IR comparators to monitor their respective inductor currents. Figure 11 is a typical application configured for single output two-phase operation.

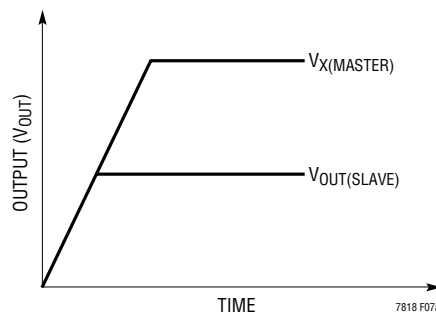

(7a) Coincident Tracking

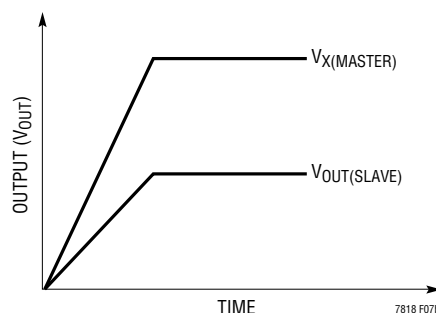

(7b) Ratiometric Tracking

Figure 7. Two Different Modes of Output Voltage Tracking

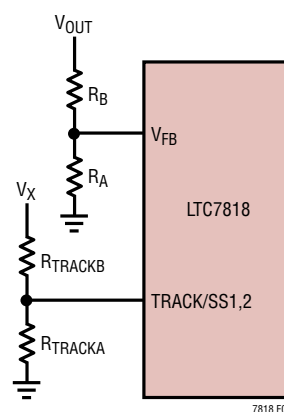

Figure 8. Using the TRACK/SS Pin for Tracking

## APPLICATIONS INFORMATION

### INTV<sub>CC</sub> Regulators

The LTC7818 features two separate internal low dropout linear regulators (LDOs) that supply power at the INTV<sub>CC</sub> pin from either the V<sub>BIAS</sub> pin or the EXTV<sub>CC</sub> pin depending on the EXTV<sub>CC</sub> pin voltage. INTV<sub>CC</sub> powers the MOSFET gate drivers and most of the internal circuitry. The V<sub>BIAS</sub> LDO and the EXTV<sub>CC</sub> LDO each regulate INTV<sub>CC</sub> to 5.1V and can provide a peak current of at least 100mA.

The INTV<sub>CC</sub> pin must be bypassed to ground with a minimum of 4.7μF ceramic capacitor, placed as close as possible to the pin. An additional 1μF ceramic capacitor placed directly adjacent to the INTV<sub>CC</sub> and GND pins is also highly recommended to supply the high frequency transient currents required by the MOSFET gate drivers.

High input voltage applications in which large MOSFETs are being driven at high frequencies may cause the maximum junction temperature rating for the LTC7818 to be exceeded. The INTV<sub>CC</sub> current, which is dominated by the gate charge current, may be supplied by either the V<sub>BIAS</sub> LDO or the EXTV<sub>CC</sub> LDO. When the voltage on the EXTV<sub>CC</sub> pin is less than 4.7V, the V<sub>BIAS</sub> LDO is enabled. Power dissipation for the IC in this case is equal to V<sub>BIAS</sub> • I<sub>INTVCC</sub>. The gate charge current is dependent on operating frequency as discussed in the Efficiency Considerations section. The junction temperature can be estimated by using the equations given in Note 2 of the Electrical Characteristics. For example, the LTC7818 INTV<sub>CC</sub> current is limited to less than 46mA from a 36V supply when not using the EXTV<sub>CC</sub> supply at a 70°C ambient temperature (Equation 22).

$$T_J = 70^\circ\text{C} + (46\text{mA})(36\text{V})(33^\circ\text{C}/\text{W}) = 125^\circ\text{C} \quad (22)$$

To prevent the maximum junction temperature from being exceeded, the input supply current must be checked while operating in continuous conduction mode (MODE = INTV<sub>CC</sub>) at maximum V<sub>BIAS</sub>.

When the voltage applied to EXTV<sub>CC</sub> rises above 4.7V, the V<sub>BIAS</sub> LDO is turned off and the EXTV<sub>CC</sub> LDO is enabled. The EXTV<sub>CC</sub> LDO remains on as long as the voltage applied to EXTV<sub>CC</sub> remains above 4.5V. The EXTV<sub>CC</sub> LDO attempts to regulate the INTV<sub>CC</sub> voltage to 5.1V, so while EXTV<sub>CC</sub> is less than 5.1V, the LDO is in dropout and the INTV<sub>CC</sub>

voltage is approximately equal to EXTV<sub>CC</sub>. When EXTV<sub>CC</sub> is greater than 5.1V (up to an absolute maximum of 30V), INTV<sub>CC</sub> is regulated to 5.1V.

Using the EXTV<sub>CC</sub> LDO allows the MOSFET driver and control power to be derived from one of the LTC7818's switching regulator outputs (4.7V ≤ V<sub>OUT</sub> ≤ 30V) during normal operation and from the V<sub>BIAS</sub> LDO when the output is out of regulation (e.g., start-up, short-circuit). If more current is required through the EXTV<sub>CC</sub> LDO than is specified, an external Schottky diode can be added between the EXTV<sub>CC</sub> and INTV<sub>CC</sub> pins. In this case, do not apply more than 6V to the EXTV<sub>CC</sub> pin.

Significant efficiency and thermal gains can be realized by powering INTV<sub>CC</sub> from a buck output, since the V<sub>IN</sub> current resulting from the driver and control currents will be scaled by a factor of V<sub>OUT</sub>/(V<sub>IN</sub> • Efficiency). For 5V to 30V regulator outputs, this means connecting the EXTV<sub>CC</sub> pin directly to V<sub>OUT</sub>. Tying the EXTV<sub>CC</sub> pin to an 8.5V supply reduces the junction temperature in Equation 22 from 125°C to 83°C given by Equation 23.

$$T_J = 70^\circ\text{C} + (46\text{mA})(8.5\text{V})(33^\circ\text{C}/\text{W}) = 83^\circ\text{C} \quad (23)$$

However, for 3.3V and other low voltage outputs, additional circuitry is required to derive INTV<sub>CC</sub> power from the output.

The following list summarizes the four possible connections for EXTV<sub>CC</sub>:

1. EXTV<sub>CC</sub> grounded. This will cause INTV<sub>CC</sub> to be powered from the internal V<sub>BIAS</sub> LDO resulting in an efficiency penalty of up to 10% or more at high input voltages.
2. EXTV<sub>CC</sub> connected directly to one of the buck regulator outputs. This is the normal connection for an application with an output in the range of 5V to 30V and provides the highest efficiency. If both buck outputs are in the 5V to 30V range, connect EXTV<sub>CC</sub> to the lesser of the two outputs to maximize efficiency.
3. EXTV<sub>CC</sub> connected to an external supply. If an external supply is available, it may be used to power EXTV<sub>CC</sub> provided that it is compatible with the MOSFET gate drive requirements. This supply may be higher or lower

## APPLICATIONS INFORMATION

than  $V_{BIAS}$ ; however, a lower  $EXTV_{CC}$  voltage results in higher efficiency.

4.  $EXTV_{CC}$  connected to an output-derived boost or charge pump. For regulators where both of the buck channel outputs are below 5V, efficiency gains can still be realized by connecting  $EXTV_{CC}$  to an output-derived voltage that has been boosted to greater than 5.1V.

### Topside MOSFET Driver Supply ( $C_B$ , $D_B$ )

External bootstrap capacitors  $C_B$  connected to the BOOST pins supply the gate drive voltages for the topside MOSFETs. Capacitor  $C_B$  in the Functional Diagram is charged through external diode  $D_B$  from  $INTV_{CC}$  when the SW pin is low.

When one of the topside MOSFETs is to be turned on, the driver places the  $C_B$  voltage across the gate-source of the desired MOSFET. This enhances the MOSFET and turns on the topside switch. The switch node voltage, SW, rises to  $V_{IN}$  for the buck channels ( $V_{OUT}$  for the boost channel) and the BOOST pin follows. With the topside MOSFET on, the boost voltage is above the input supply:  $V_{BOOST} = V_{IN} + V_{INTV_{CC}}$  (or for the boost controller,  $V_{BOOST} = V_{OUT} + V_{INTV_{CC}}$ ). The value of the boost capacitor  $C_B$  needs to be 100 times that of the total input capacitance of the topside MOSFET(s). For a typical application, a value of  $C_B = 0.1\mu F$  is generally sufficient.

The external diode  $D_B$  can be a Schottky diode or silicon diode, but in either case it should have low leakage and fast recovery. The reverse breakdown of the diode must be greater than  $V_{IN(MAX)}$ . Pay close attention to the reverse leakage at high temperatures where it generally increases substantially.

A leaky diode not only increases the quiescent current of the buck converter, but it can create current path from the BOOST pin to  $INTV_{CC}$ . This will cause  $INTV_{CC}$  to rise if the diode leakage exceeds the current consumption on  $INTV_{CC}$ , which is primarily a concern in Burst Mode operation where the load on  $INTV_{CC}$  can be very small. There is an internal voltage clamp on  $INTV_{CC}$  that prevents the  $INTV_{CC}$  voltage from running away, but this clamp should be regarded as a failsafe only.

The topside MOSFET driver for the boost channel includes an internal charge pump that delivers current to the bootstrap capacitor from the BOOST3 pin. This charge current maintains the bias voltage required to keep the top MOSFET on continuously during dropout/overvoltage conditions. Curves displaying the available charge pump current under different operating conditions can be found in the Typical Performance Characteristics section.

### Minimum On-Time Considerations

Minimum on-time  $t_{ON(MIN)}$  is the smallest time duration that the LTC7818 is capable of turning on the top MOSFET (or bottom MOSFET for the boost controller). It is determined by internal timing delays and the gate charge required to turn on the MOSFET. Low duty cycle applications may approach this minimum on-time limit and care should be taken to ensure Equation 24.

$$t_{ON(MIN)\_BUCK} < \frac{V_{OUT}}{V_{IN} \cdot f} \quad (24)$$

$$t_{ON(MIN)\_BOOST} < \frac{V_{OUT} - V_{IN}}{V_{OUT} \cdot f}$$

If the duty cycle falls below what can be accommodated by the minimum on-time, the controller will begin to skip cycles. The output voltage will continue to be regulated, but the ripple voltage and current will increase. The minimum on-time for the LTC7818 is approximately 40ns for the bucks and 80ns for the boost. However, as the peak sense voltage decreases the minimum on-time for the bucks gradually increases up to about 60ns. This is of particular concern in forced continuous applications with low ripple current at light loads. If the duty cycle drops below the minimum on-time limit in this situation, a significant amount of cycle skipping can occur with correspondingly larger current and voltage ripple.

### Boost Channel Current Monitor (IMON3)

The boost channel inductor current can be monitored at the IMON3 pin. This pin generates a voltage that represents a scaled and filtered version of the inductor current sensed through the SENSE3+ and SENSE3- pins.

## APPLICATIONS INFORMATION

The DC voltage on IMON3 normally varies between 0.4V and 1.4V, corresponding to a sensed inductor current  $I_L$  between 0% and 100% of the maximum designed inductor current  $I_{L(MAX)}$  as given by Equation 25.

$$V_{IMON3} = 1V \cdot \frac{I_L}{I_{L(MAX)}} + 0.4V \quad (25)$$

The IMON3 voltage may momentarily be less than 0.4V or greater than 1.4V, but eventually is limited to these levels by the current loop. When all three channels are in Sleep, this pin is held at 0.4V. An internal 30k resistor is in series with the IMON3 buffer to facilitate filtering of the sensed inductor current ripple. Place a capacitor from IMON3 to ground to filter the ripple and achieve an average current measurement over multiple switching cycles.

### Fault Conditions: Buck Current Limit and Foldback

The LTC7818 includes current foldback for the buck channels to reduce the load current when the output is shorted to ground. If the output voltage falls below 50% of its regulation point, then the maximum sense voltage is progressively lowered from 100% to 40% of its maximum value. Under short-circuit conditions with very low duty cycles, the LTC7818 will begin cycle skipping to limit the short circuit current. In this situation the bottom MOSFET dissipates most of the power but less than in normal operation. The short-circuit ripple current is determined by the minimum on-time,  $t_{ON(MIN)} \approx 40ns$ , the input voltage and inductor value as given by Equation 26.

$$\Delta I_{L(SC)} = t_{ON(MIN)} \cdot V_{IN}/L \quad (26)$$

The resulting average short-circuit current is given by Equation 27.

$$I_{SC} = 40\% \cdot I_{LIM(MAX)} - \Delta I_{L(SC)}/2 \quad (27)$$

### Fault Conditions: Buck Overvoltage Protection (Crowbar)

The overvoltage crowbar is designed to blow a system input fuse when the output voltage of the regulator rises much higher than nominal levels. The crowbar causes huge currents to flow that blow the fuse to protect against a shorted top MOSFET if the short occurs while the controller is operating.

If a buck output voltage rises 10% above the set regulation point, the top MOSFET is turned off and the bottom MOSFET is turned on until the overvoltage condition is cleared. The bottom MOSFET remains on continuously for as long as the overvoltage condition persists; if  $V_{OUT}$  returns to a safe level, normal operation automatically resumes.

A shorted top MOSFET will result in a high current condition which will open the system fuse. The switching regulator will regulate properly with a leaky top MOSFET by altering the duty cycle to accommodate the leakage.

### Fault Conditions: Overtemperature Protection

At higher temperatures, or in cases where the internal power dissipation causes excessive self-heating (such as a short from  $INTV_{CC}$  to ground) internal overtemperature shutdown circuitry will shut down the LTC7818. When the internal die temperature exceeds 180°C, the  $INTV_{CC}$  LDO and gate drivers are disabled. When the die cools to 160°C, the LTC7818 enables the  $INTV_{CC}$  LDO and resumes operation beginning with a soft-start startup. Long-term overstress ( $T_J > 125^\circ C$ ) should be avoided as it can degrade the performance or shorten the life of the part.

### Phase-Locked Loop and Frequency Synchronization

The LTC7818 has an internal phase-locked loop (PLL) which allows the turn-on of the top MOSFET of controller 1 to be synchronized to the rising edge of an external clock signal applied to the PLLIN/SPREAD pin. The turn on of controller 2's top MOSFET is thus 180° out-of-phase with the external clock.

Rapid phase-locking can be achieved by using the  $FREQ$  pin to set a free-running frequency near the desired synchronization frequency. Before synchronization, the PLL is prebiased to the frequency set by the  $FREQ$  pin. Consequently, the PLL only needs to make minor adjustments to achieve phase-lock and synchronization. Although it is not required that the free-running frequency be near the external clock frequency, doing so will prevent the oscillator from passing through a large range of frequencies as the PLL locks.

## APPLICATIONS INFORMATION

When synchronized to an external clock, the LTC7818 operates in pulse skipping mode if it is selected by the MODE pin, or in forced continuous mode otherwise. The LTC7818 is guaranteed to synchronize to an external clock applied to the PLLIN/SPREAD pin that swings up to at least 2.5V and down to 0.5V or less. Note that the LTC7818 can only be synchronized to an external clock frequency within the range of 100kHz to 3MHz.

### Efficiency Considerations

The percent efficiency of a switching regulator is equal to the output power divided by the input power times 100%. It is often useful to analyze individual losses to determine what is limiting the efficiency and which change would produce the most improvement. Percent efficiency can be expressed by using Equation 28.

$$\% \text{Efficiency} = 100\% - (L1 + L2 + L3 + \dots) \quad (28)$$

where L1, L2, etc. are the individual losses as a percentage of input power.

Although all dissipative elements in the circuit produce losses, four main sources usually account for most of the losses in LTC7818 circuits: 1) IC  $V_{\text{BIAS}}$  current, 2)  $\text{INTV}_{\text{CC}}$  regulator current, 3)  $I^2R$  losses, 4) Topside MOSFET transition losses.

1. The  $V_{\text{BIAS}}$  current is the DC supply current given in the Electrical Characteristics table, which excludes MOSFET driver and control currents. Other than at very light loads in Burst Mode operation,  $V_{\text{BIAS}}$  current typically results in a small (<0.1%) loss.
2.  $\text{INTV}_{\text{CC}}$  current is the sum of the MOSFET driver and control currents. The MOSFET driver current results from switching the gate capacitance of the power MOSFETs. Each time a MOSFET gate is switched from low to high to low again, a packet of charge,  $dQ$ , moves from  $\text{INTV}_{\text{CC}}$  to ground. The resulting  $dQ/dt$  is a current out of  $\text{INTV}_{\text{CC}}$  that is typically much larger than the control circuit current. In continuous mode,  $I_{\text{GATECHG}} = f_{\text{SW}}(Q_{\text{T}} + Q_{\text{B}})$ , where  $Q_{\text{T}}$  and  $Q_{\text{B}}$  are the gate charges of the top and bottom MOSFETs.

Supplying  $\text{INTV}_{\text{CC}}$  from an output-derived source through  $\text{EXTV}_{\text{CC}}$  will scale the  $V_{\text{IN}}$  current required for the driver and control circuits by a factor of  $V_{\text{OUT}} / (V_{\text{IN}} \cdot \text{Efficiency})$ . For example, in a 20V to 5V application, 10mA of  $\text{INTV}_{\text{CC}}$  current results in approximately 2.5mA of  $V_{\text{IN}}$  current. This reduces the mid-current loss from 10% or more (if the driver was powered directly from  $V_{\text{IN}}$ ) to only a few percent.

3.  $I^2R$  losses are predicted from the DC resistances of the input fuse (if used), MOSFET, inductor, current sense resistor, and input and output capacitor ESR. In continuous mode the average output current flows through L and  $R_{\text{SENSE}}$ , but is “chopped” between the top and bottom MOSFETs. If the two MOSFETs have approximately the same  $R_{\text{DS(ON)}}$ , then the resistance of one MOSFET can simply be summed with the resistances of L,  $R_{\text{SENSE}}$  and ESR to obtain  $I^2R$  losses.

For example, if each  $R_{\text{DS(ON)}} = 30\text{m}\Omega$ ,  $R_{\text{L}} = 50\text{m}\Omega$ ,  $R_{\text{SENSE}} = 10\text{m}\Omega$  and  $\text{ESR} = 40\text{m}\Omega$  (sum of both input and output capacitance losses), then the total resistance is 130mΩ. This results in losses ranging from 3% to 13% as the output current increases from 1A to 5A for a 5V output, or a 4% to 20% loss for a 3.3V output. This loss varies as the inverse square of  $V_{\text{OUT}}$  for the same external components and output power level. The combined effects of increasingly lower output voltages and higher currents required by high performance digital systems is not doubling but quadrupling the importance of loss terms in the switching regulator system!

4. Transition losses apply only to the top MOSFETs for the bucks (bottom MOSFET for the boost), and become significant only when operating at higher input voltages (typically 15V or greater). Transition losses can be estimated from Equation 11, Equation 12, and Equation 13 for the main switch power dissipation in the Power MOSFET Selection section.

Other hidden losses such as copper trace and internal battery resistances can account for an additional 5% to 10% efficiency degradation in portable systems. It is very important to include these “system” level losses during

## APPLICATIONS INFORMATION

the design phase. The internal battery and fuse resistance losses can be minimized by making sure that  $C_{IN}$  has adequate charge storage and very low ESR at the switching frequency. A 25W supply will typically require a minimum of 20 $\mu$ F to 40 $\mu$ F of capacitance having a maximum of 20m $\Omega$  to 50m $\Omega$  of ESR. The LTC7818 2-phase architecture typically halves this input capacitance requirement over competing solutions. Other losses including inductor core losses generally account for less than 2% total additional loss.

### Checking Transient Response

The regulator loop response can be checked by looking at the load current transient response. Switching regulators take several cycles to respond to a step in DC (resistive) load current. When a load step occurs,  $V_{OUT}$  shifts by an amount equal to  $\Delta I_{LOAD} \cdot (ESR)$ , where ESR is the effective series resistance of  $C_{OUT}$ .  $\Delta I_{LOAD}$  also begins to charge or discharge  $C_{OUT}$  generating the feedback error signal that forces the regulator to adapt to the current change and return  $V_{OUT}$  to its steady-state value. During this recovery time  $V_{OUT}$  can be monitored for excessive overshoot or ringing, which would indicate a stability problem.

OPTI-LOOP compensation allows the transient response to be optimized over a wide range of output capacitance and ESR values. The availability of the ITH pin not only allows optimization of control loop behavior, but it also provides a DC coupled and AC filtered closed loop response test point. The DC step, rise time and settling at this test point truly reflects the closed loop response. Assuming a predominantly second order system, phase margin and/or damping factor can be estimated using the percentage of overshoot seen at this pin. The bandwidth can also be estimated by examining the rise time at the pin. The ITH external components shown in the Typical Applications circuits provide an adequate starting point for most applications.

The ITH series  $R_C$ - $C_C$  filter sets the dominant pole-zero loop compensation. The values can be modified slightly (from 0.5 to 2 times their initial values) to optimize transient response once the final PC layout is done and the

particular output capacitor type and value have been determined. The output capacitors need to be selected because the various types and values determine the loop gain and phase. An output current pulse of 20% to 80% of full load current having a rise time of 1 $\mu$ s to 10 $\mu$ s will produce output voltage and ITH pin waveforms that will give a sense of the overall loop stability without breaking the feedback loop.

Placing a power MOSFET directly across the output capacitor and driving the gate with an appropriate signal generator is a practical way to produce a realistic load step condition. The initial output voltage step resulting from the step change in output current may not be within the bandwidth of the feedback loop, so this signal cannot be used to determine phase margin. This is why it is better to look at the ITH pin signal which is in the feedback loop and is the filtered and compensated control loop response.

The gain of the loop will be increased by increasing  $R_C$  and the bandwidth of the loop will be increased by decreasing  $C_C$ . If  $R_C$  is increased by the same factor that  $C_C$  is decreased, the zero frequency will be kept the same, thereby keeping the phase shift the same in the most critical frequency range of the feedback loop. The output voltage settling behavior is related to the stability of the closed-loop system and will demonstrate the actual overall supply performance.

A second, more severe transient is caused by switching in loads with large (>1 $\mu$ F) supply bypass capacitors. The discharged bypass capacitors are effectively put in parallel with  $C_{OUT}$ , causing a rapid drop in  $V_{OUT}$ . No regulator can alter its delivery of current quickly enough to prevent this sudden step change in output voltage if the load switch resistance is low and it is driven quickly. If the ratio of  $C_{LOAD}$  to  $C_{OUT}$  is greater than 1:50, the switch rise time should be controlled so that the load rise time is limited to approximately  $C_{LOAD} \cdot 25\mu\text{s}/\mu\text{F}$ . Thus a 10 $\mu$ F capacitor would require a 250 $\mu$ s rise time, limiting the charging current to about 200mA.

### Buck Design Example

As a design example for one of the buck channels, assume  $V_{IN(NOMINAL)} = 12\text{V}$ ,  $V_{IN(MAX)} = 22\text{V}$ ,  $V_{OUT} = 3.3\text{V}$ ,  $I_{OUT} = 20\text{A}$ , and  $f_{SW} = 1\text{MHz}$ .



## APPLICATIONS INFORMATION

1. Set the operating frequency. The frequency is not one of the internal preset values, so a resistor from the FREQ pin to GND is required, with a value given by Equation 29.

$$R_{\text{FREQ}} \text{ (in } k\Omega) = \frac{37\text{MHz}}{1\text{MHz}} = 37k\Omega \quad (29)$$

2. Determine the inductor value. Initially select a value based on an inductor ripple current of 30%. The inductor value can then be calculated by Equation 30.

$$L = \frac{V_{\text{OUT}}}{f_{\text{SW}}(\Delta I_L)} \left( 1 - \frac{V_{\text{OUT}}}{V_{\text{IN(NOM)}}} \right) = 0.4\mu\text{H} \quad (30)$$

The highest value of ripple current occurs at the maximum input voltage. In this case the ripple at  $V_{\text{IN}} = 22\text{V}$  is 35%

3. Verify that the minimum on-time of 40ns is not violated. The minimum on-time occurs at  $V_{\text{IN(MAX)}}$  (Equation 31).

$$t_{\text{ON(MIN)}} = \frac{V_{\text{OUT}}}{V_{\text{IN(MAX)}}(f_{\text{SW}})} = 150\text{ns} \quad (31)$$

This is more than sufficient to satisfy the minimum on time requirement. If the minimum on time is violated, the LTC7818 skips pulses at high input voltage, resulting in lower frequency operation and higher inductor current ripple than desired. If undesirable, this behavior can be avoided by decreasing the frequency (with the inductor value accordingly adjusted) to avoid operation near the minimum on-time.

4. Select the  $R_{\text{SENSE}}$  resistor value. The peak inductor current is the maximum DC output current plus half of the inductor ripple current. Or  $20\text{A} \cdot (1+0.30/2) = 23\text{A}$  in this case. The  $R_{\text{SENSE}}$  resistor value can then be calculated based on the minimum value for the maximum current sense threshold (45mV) given by Equation 32.

$$R_{\text{SENSE}} \leq \frac{45\text{mV}}{23\text{A}} \cong 2\text{m}\Omega \quad (32)$$

To allow for additional margin, a lower value  $R_{\text{SENSE}}$  may be used (for example, 1.8m $\Omega$ ); however, be sure that the inductor saturation current has sufficient margin above  $V_{\text{SENSE(MAX)}}/R_{\text{SENSE}}$ , where the maximum value of 55mV is used for  $V_{\text{SENSE(MAX)}}$ .

For this low inductor value and high current application, an RC filter into the sense pins should be used to compensate for the parasitic inductance (ESL) of the sense resistor. Assuming an  $R_{\text{SENSE}}$  geometry of 1225 with a parasitic inductance of 0.2nH, the RC filter time constant should be  $RC = \text{ESL}/R_{\text{SENSE}} = 0.2\text{nH}/2\text{m}\Omega = 100\text{ns}$ , which may be implemented with 100 $\Omega$  resistor in series with the SENSE<sup>+</sup> pin and 1nF capacitor between SENSE<sup>+</sup> and SENSE<sup>-</sup>.

5. Select the feedback resistors. If very light load efficiency is required, high value feedback resistors may be used to minimize the current due to the feedback divider. However, in most applications a feedback divider current in the range of 10 $\mu\text{A}$  to 100 $\mu\text{A}$  or more is acceptable. For a 50 $\mu\text{A}$  feedback divider current,  $R_A = 0.8\text{V}/50\mu\text{A} = 16\text{k}\Omega$ .  $R_B$  can then be calculated as  $R_B = R_A(3.3\text{V}/0.8\text{V} - 1) = 50\text{k}\Omega$ .
6. Select the MOSFETs. The best way to evaluate MOSFET performance in a particular application is to build and test the circuit on the bench, facilitated by an LTC7818 demo board. However, an educated guess about the application is helpful to initially select MOSFETs. Since this is a high current, low voltage application,  $I^2R$  losses will likely dominate over transition losses for the top MOSFET. Therefore, choose a MOSFET with lower  $R_{\text{DS(ON)}}$  as opposed to lower gate charge to minimize the combined loss terms. The bottom MOSFET does not experience transition losses, and its power loss is generally dominated by  $I^2R$  losses. For this reason, the bottom MOSFET is typically chosen to be of lower  $R_{\text{DS(ON)}}$  and subsequently higher gate charge than the top MOSFET.

Due to the high current in this application, two MOSFETs may be needed in parallel to more evenly balance the dissipated power and to lower the  $R_{\text{DS(ON)}}$ . Be sure to select logic-level threshold MOSFETs, since the gate drive voltage is limited to 5.1V (INTV<sub>CC</sub>).

7. Select the input and output capacitors.  $C_{\text{IN}}$  is chosen for an RMS current rating of at least 10A ( $I_{\text{OUT}}/2$ , with margin) at temperature assuming only this channel is on.  $C_{\text{OUT}}$  is chosen with an ESR of 3m $\Omega$  for low output ripple. Multiple capacitors connected in parallel may

## APPLICATIONS INFORMATION

be required to reduce the ESR to this level. The output ripple in continuous mode will be highest at the maximum input voltage. The output voltage ripple due to ESR is approximately given by Equation 33.

$$V_{\text{ORIPPLE}} = \text{ESR} \cdot \Delta I_L = 3\text{m}\Omega \cdot 6\text{A} = 18\text{mV}_{\text{P-P}} \quad (33)$$

On the 3.3V output, this is equal to 0.55% of peak to peak voltage ripple.

- Determine the bias supply components. Since the regulated output is not greater than the  $\text{EXTV}_{\text{CC}}$  switchover threshold (4.7V), it cannot be used to bias  $\text{INTV}_{\text{CC}}$ . However, if another supply is available, for example if the other buck channel is regulating to 5V, connect that supply to  $\text{EXTV}_{\text{CC}}$  to improve the efficiency. For a 6.5ms soft start, select a 0.1 $\mu\text{F}$  capacitor for the TRACK/SS pin. As a first pass estimate for the bias components, select  $C_{\text{INTV}_{\text{CC}}} = 4.7\mu\text{F}$ , boost supply capacitor  $C_B = 0.1\mu\text{F}$  and low forward drop boost supply diode CMD5H-4E from Central Semiconductor.
- Determine and set application-specific parameters. Set the MODE pin based on the trade-off of light load efficiency and constant-frequency operation. Set the PLLIN/SPREAD pin based on whether a fixed, spread spectrum, or phase-locked frequency is desired. The RUN pin can be used to control the minimum input voltage for regulator operation or can be tied to  $V_{\text{IN}}$  for always-on operation. Use ITH compensation components from the Typical Applications as a first guess, check the transient response for stability, and modify as necessary.

### PC Board Layout Checklist

When laying out the printed circuit board, the following checklist should be used to ensure proper operation of the IC. Figure 9 illustrates the current waveforms present in the various branches of the 2-phase synchronous buck regulators operating in the continuous mode. Check the following in your layout:

- Are the top N-channel MOSFETs located within 1cm of each other with a common drain connection at  $C_{\text{IN}}$ ? Do not attempt to split the input decoupling for the two channels as it can cause a large resonant loop.
- Are the signal and power grounds kept separate? The combined IC ground pin and the ground return of  $C_{\text{INTV}_{\text{CC}}}$  must return to the combined  $C_{\text{OUT}}$  (–) terminals. The path formed by the top N-channel MOSFET and the  $C_{\text{IN}}$  capacitor should have short leads and PC trace lengths. The output capacitor (–) terminals should be connected as close as possible to the (–) terminals of the input capacitor by placing the capacitors next to each other and away from the loop described above.
- Do the LTC7818  $V_{\text{FB}}$  pins' resistive dividers connect to the (+) terminals of  $C_{\text{OUT}}$ ? The resistive divider must be connected between the (+) terminal of  $C_{\text{OUT}}$  and signal ground. Place the divider close to the  $V_{\text{FB}}$  pin to minimize noise coupling into the sensitive  $V_{\text{FB}}$  node. The feedback resistor connections should not be along the high current input feeds from the input capacitor(s).
- Are the  $\text{SENSE}^-$  and  $\text{SENSE}^+$  leads routed together with minimum PC trace spacing? Route these traces away from the high frequency switching nodes, on an inner layer if possible. The filter capacitor between  $\text{SENSE}^+$  and  $\text{SENSE}^-$  should be as close as possible to the IC. Ensure accurate current sensing with Kelvin connections at the sense resistor.
- Is the  $\text{INTV}_{\text{CC}}$  decoupling capacitor connected close to the IC, between the  $\text{INTV}_{\text{CC}}$  and the power ground pin? This capacitor carries the MOSFET drivers' current peaks. An additional 1 $\mu\text{F}$  ceramic capacitor placed immediately next to the  $\text{INTV}_{\text{CC}}$  and GND pins can help improve noise performance substantially.
- Keep the switching nodes (SW1, SW2, SW3), top gate nodes (TG1, TG2, TG3), and boost nodes (BOOST1, BOOST2, BOOST3) away from sensitive small-signal nodes, especially from the other channel's voltage and current sensing feedback pins. All of these nodes have very large and fast-moving signals and therefore should be kept on the output side of the LTC7818 and occupy minimum PC trace area. Minimize the inductance of the TG and BG gate drive traces and their respective return paths to the controller IC (SW and GND) by using wide traces and multiple parallel vias.

## APPLICATIONS INFORMATION

7. Use a modified star ground technique: a low impedance, large copper area central grounding point on the same side of the PC board as the input and output capacitors with tie-ins for the bottom of the  $INTV_{CC}$  decoupling capacitor, the bottom of the voltage feedback resistive divider and the GND pin of the IC.

### PC Board Layout Debugging

Start with one controller on at a time. It is helpful to use a DC-50MHz current probe to monitor the current in the inductor while testing the circuit. Monitor the output switching node (SW pin) to synchronize the oscilloscope to the internal oscillator and probe the actual output voltage as well. Check for proper performance over the operating voltage and current range expected in the application. The frequency of operation should be maintained over the input voltage range down to dropout and until the output load drops below the low current operation threshold—typically 25% of the maximum designed current level in Burst Mode operation.

The duty cycle percentage should be maintained from cycle to cycle in a well-designed, low noise PCB implementation. Variation in the duty cycle at a subharmonic rate can suggest noise pickup at the current or voltage sensing inputs or inadequate loop compensation. Overcompensation of the loop can be used to tame a poor PC layout if regulator bandwidth optimization is not required. Only after each controller is checked for its individual performance should both controllers be turned on at the same time. A particularly difficult region of operation is when one controller channel is nearing its current comparator trip point when the other channel is turning on its top MOSFET. This occurs around 50% duty cycle on either channel due to the phasing of the internal clocks and may cause minor duty cycle jitter.

Reduce  $V_{IN}$  from its nominal level to verify operation of the regulator in dropout. Check the operation of the undervoltage lockout circuit by further lowering  $V_{IN}$  while monitoring the outputs to verify operation. Investigate whether any problems exist only at higher output currents or only at higher input voltages. If problems coincide with high input voltages and low output currents, look for capacitive coupling between the BOOST, SW, TG, and possibly BG connections and the sensitive voltage and current pins. The capacitor placed across the current sensing pins needs to be placed immediately adjacent to the pins of the IC. This capacitor helps to minimize the effects of differential noise injection due to high frequency capacitive coupling. If problems are encountered with high current output loading at lower input voltages, look for inductive coupling between  $C_{IN}$ , the top MOSFET, and the bottom MOSFET components to the sensitive current and voltage sensing traces. In addition, investigate common ground path voltage pickup between these components and the GND pin of the IC.

An embarrassing problem, which can be missed in an otherwise properly working switching regulator, results when the current sensing leads are hooked up backwards. The output voltage under this improper hookup will still be maintained but the advantages of current mode control will not be realized. Compensation of the voltage loop will be much more sensitive to component selection. This behavior can be investigated by temporarily shorting out the current sensing resistor—don't worry, the regulator will still maintain control of the output voltage.

APPLICATIONS INFORMATION

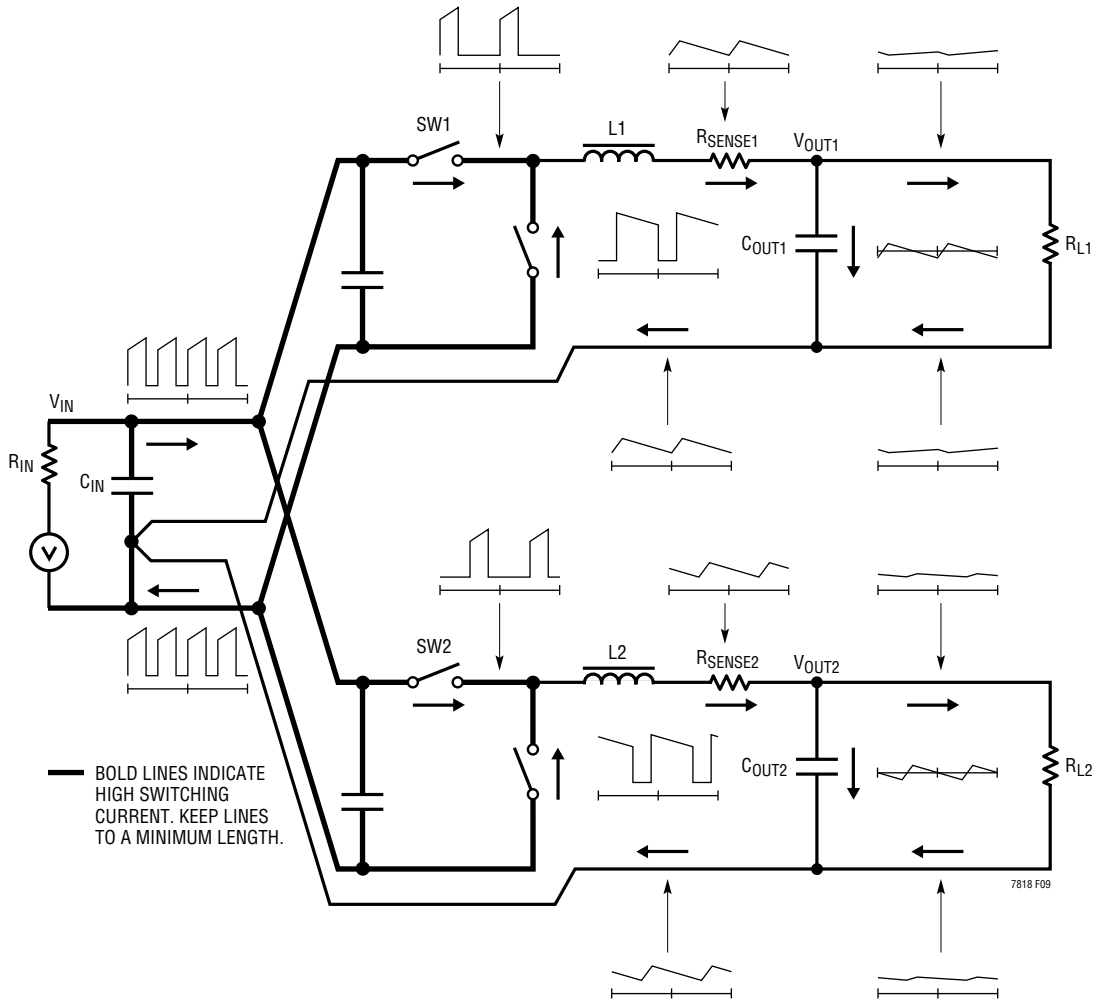
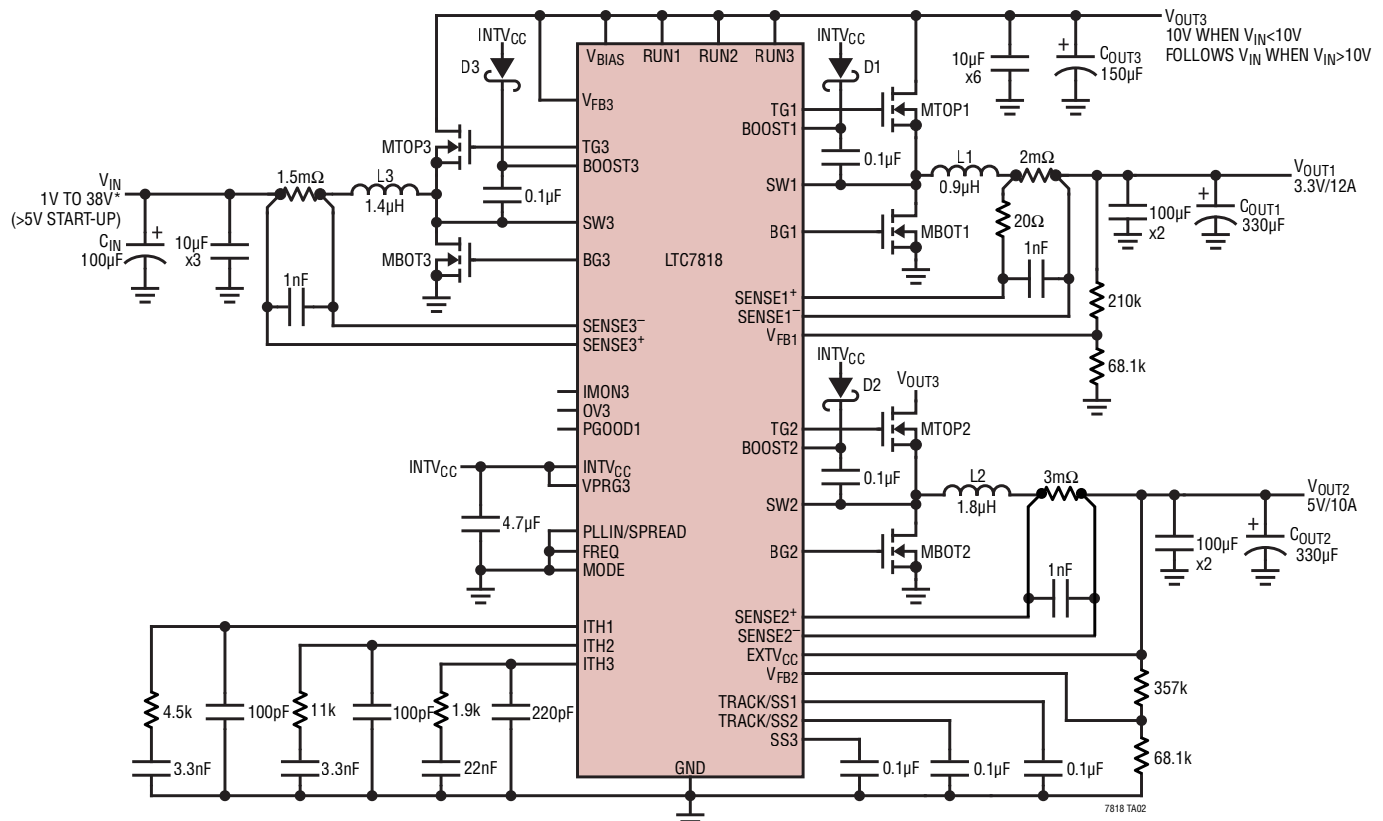

Figure 9. Branch Current Waveforms for Bucks

TYPICAL APPLICATIONS



- M1,2: INFINEON BSC059N04LS6
- M3: INFINEON BSC022N04LS6
- M4: INFINEON BSC059N04LS6
- L1: WURTH 744355090
- L2: WURTH 744313180
- L3: WURTH 7443550140
- D1,2,3: CENTRAL SEMI CMDSH-4E
- C\_IN: SUNCON 63CE100LX
- C\_OUT1,2: KEMET T520V337M006ATE015
- C\_OUT3: SUNCON 50HVPF150M

$f_{sw} = 380kHz$

\* WHEN  $V_{IN} < 4V$ , MAXIMUM LOAD CURRENT AVAILABLE IS REDUCED

\* OUTPUT CURRENT CAPABILITY AT HIGH INPUT VOLTAGES MAY BE LIMITED BY THE THERMAL CHARACTERISTICS OF THE OVERALL SYSTEM AND PRINTED CIRCUIT BOARD DESIGN

(10a)

Efficiency vs Load Current

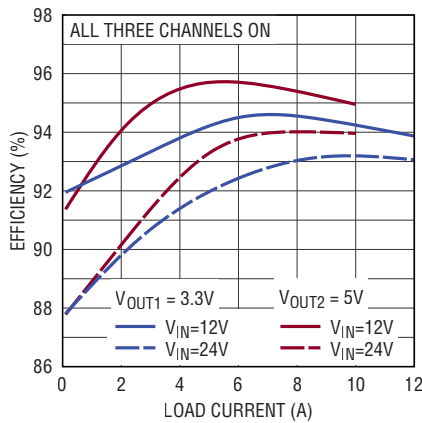

(10b)

No-Load Burst Mode Input Current vs Input Voltage

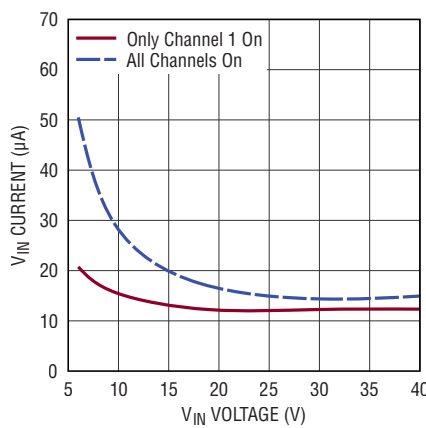

(10c)

Short-Circuit Response

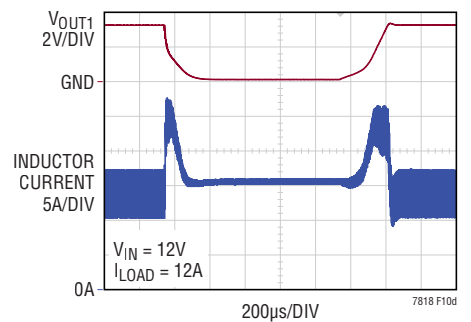

(10d)

Figure 10. High Efficiency Wide Input Range Dual 5V/3.3V Regulator

## TYPICAL APPLICATIONS

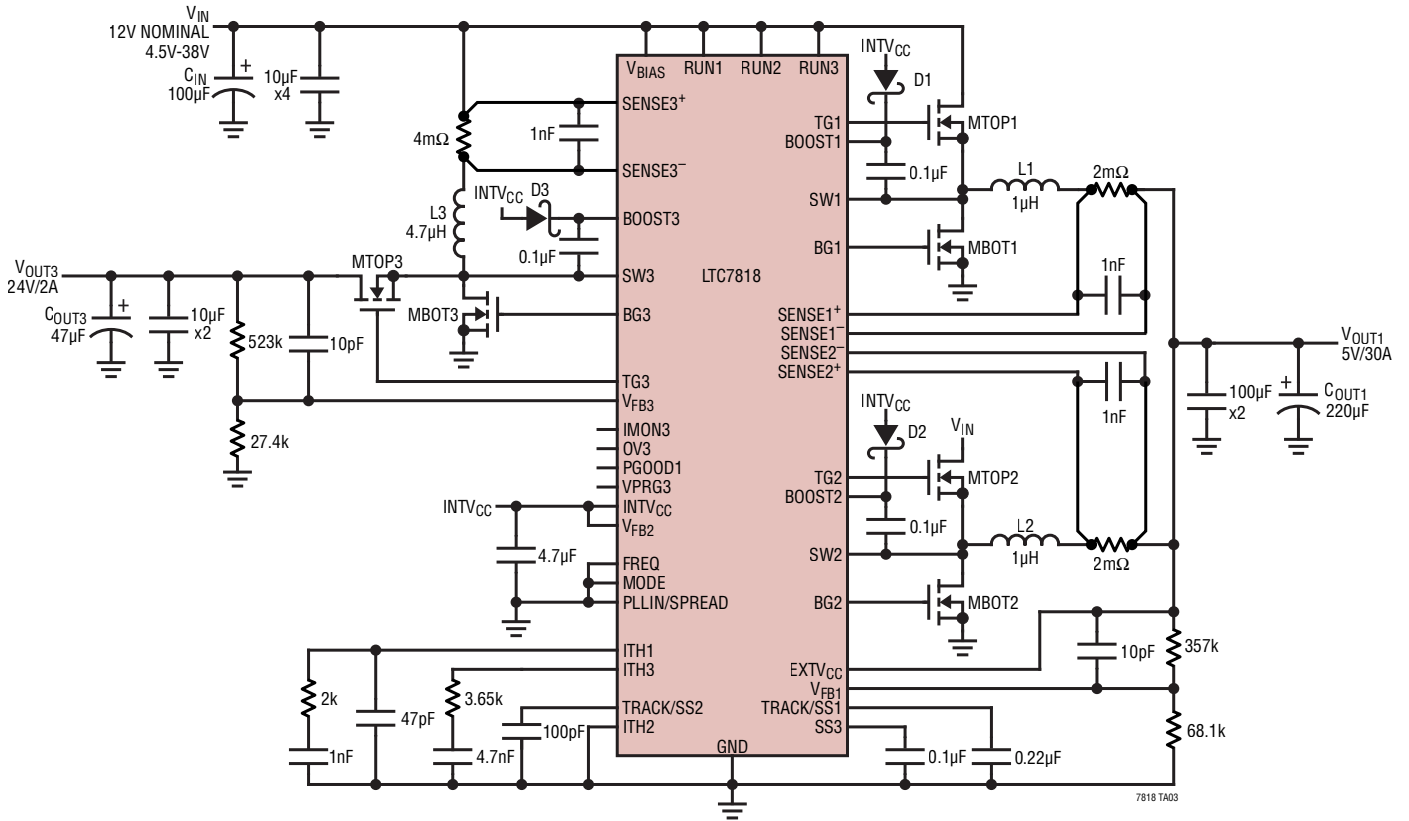

MTOP1,2: INFINEON BSC059N04LS6  
 MBOT1,2: INFINEON BSC022N04LS6  
 MTOP3: INFINEON BSC059N04LS6  
 MBOT3: INFINEON BSC059N04LS6  
 L1,2: COILCRAFT XAL1580-102ME  
 L3: COILCRAFT XAL1010-472ME  
 D1,2,3: CENTRAL SEMI CMDSH-4E  
 C<sub>IN</sub>: SUNCON 63HVPF100M  
 C<sub>OUT1</sub>: PANASONIC 6TPF220M5L  
 C<sub>OUT3</sub>: SUNCON 63CE47LX  
 f<sub>sw</sub>=380kHz  
 V<sub>OUT1</sub> FOLLOWS V<sub>IN</sub> WHEN V<sub>IN</sub> < 5V  
 V<sub>OUT3</sub> FOLLOWS V<sub>IN</sub> WHEN V<sub>IN</sub> > 24V

(11a)

**Two-Phase Buck Load Step Transient Response**

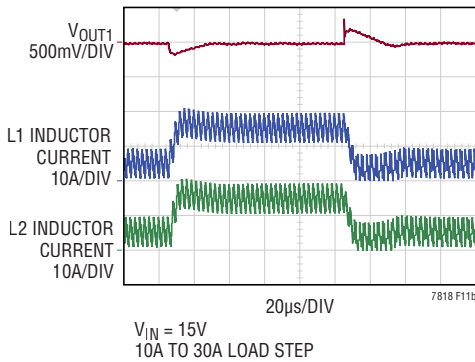

(11b)

**Efficiency vs Load Current**

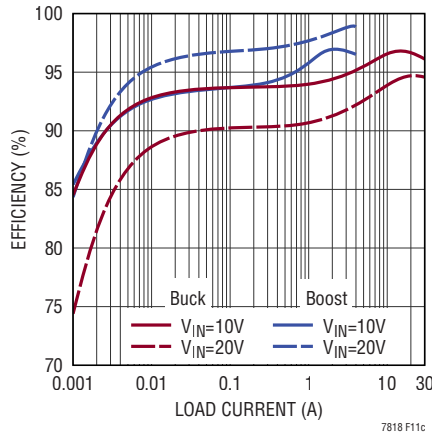

(11c)

**Efficiency vs Input Voltage**

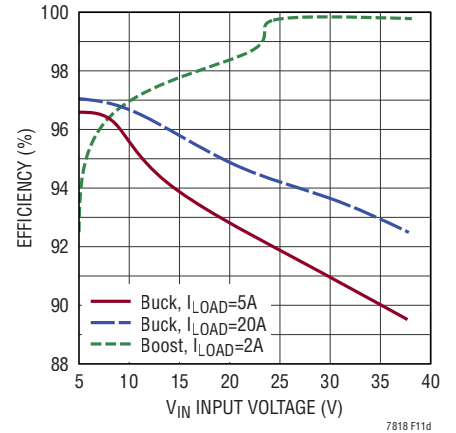

(11d)

**Figure 11. High Efficiency 380kHz Wide Input Range 24V/2A Boost and Two-Phase 5V/30A Buck Regulator**



## TYPICAL APPLICATIONS

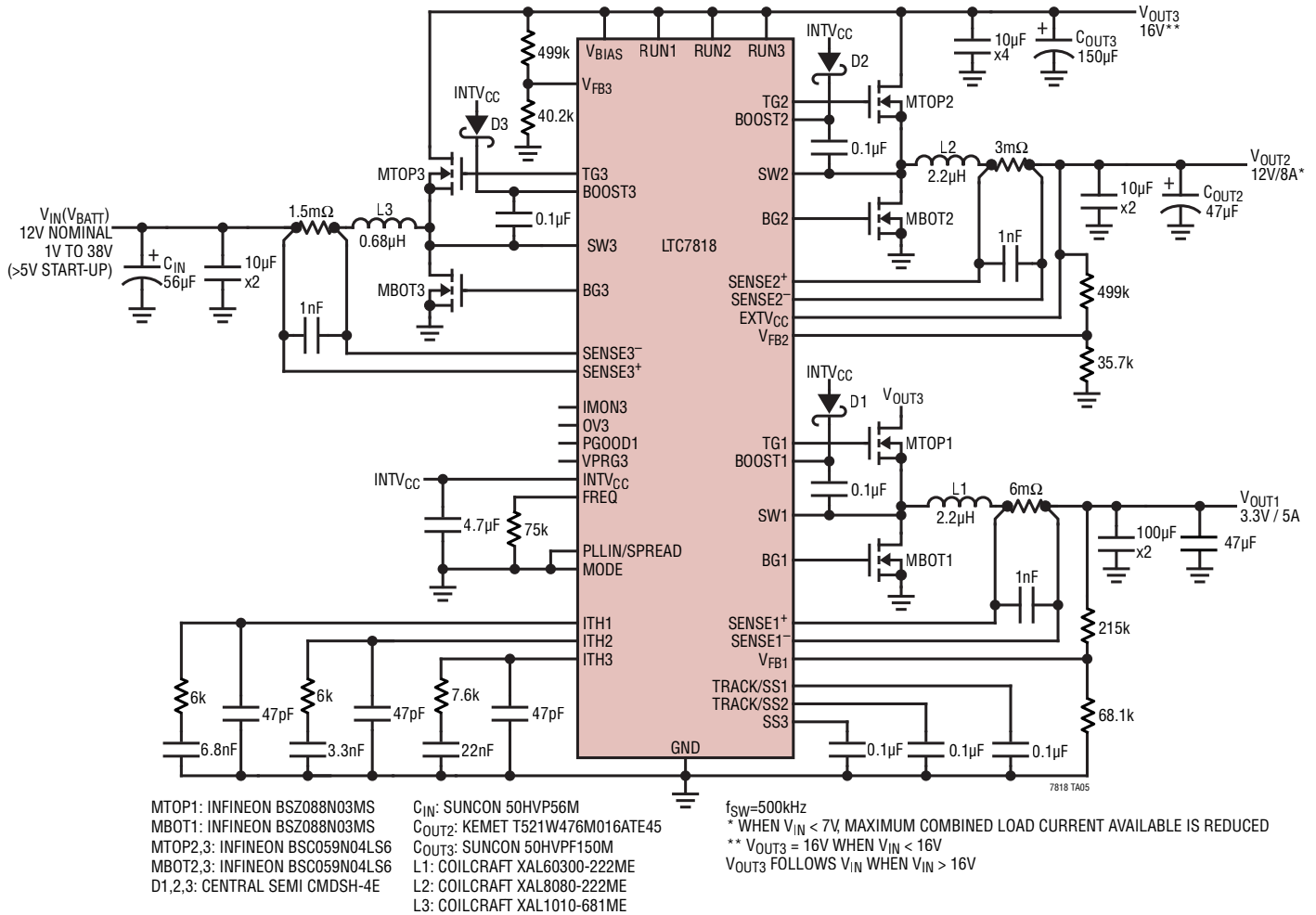

(13a)

**$V_{OUT2}$  Typical Current Limit vs  $V_{IN}$  Input Voltage**

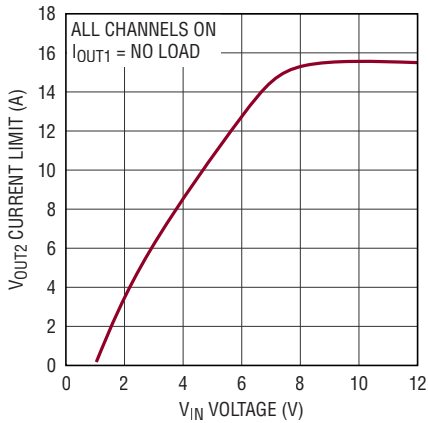

(13b)

**Cold Crank Transient Response**

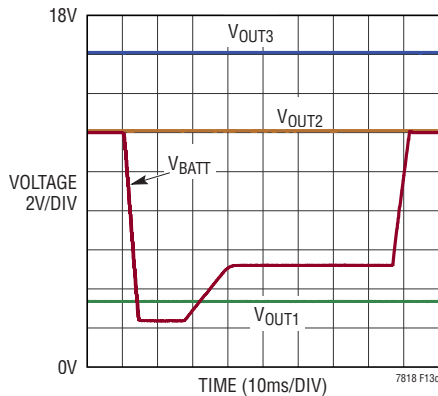

(13c)

**$V_{OUT2}$  Efficiency vs Load Current**

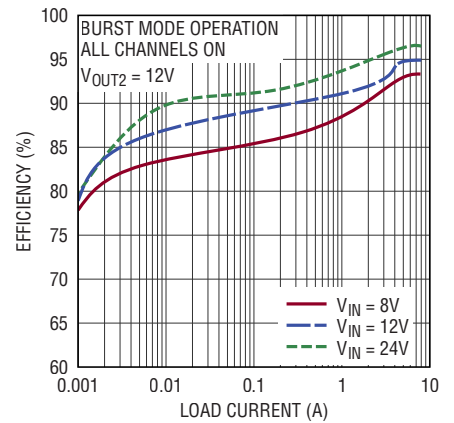

(13d)

Figure 13. High Efficiency Wide Input Range 12V Regulator



TYPICAL APPLICATIONS

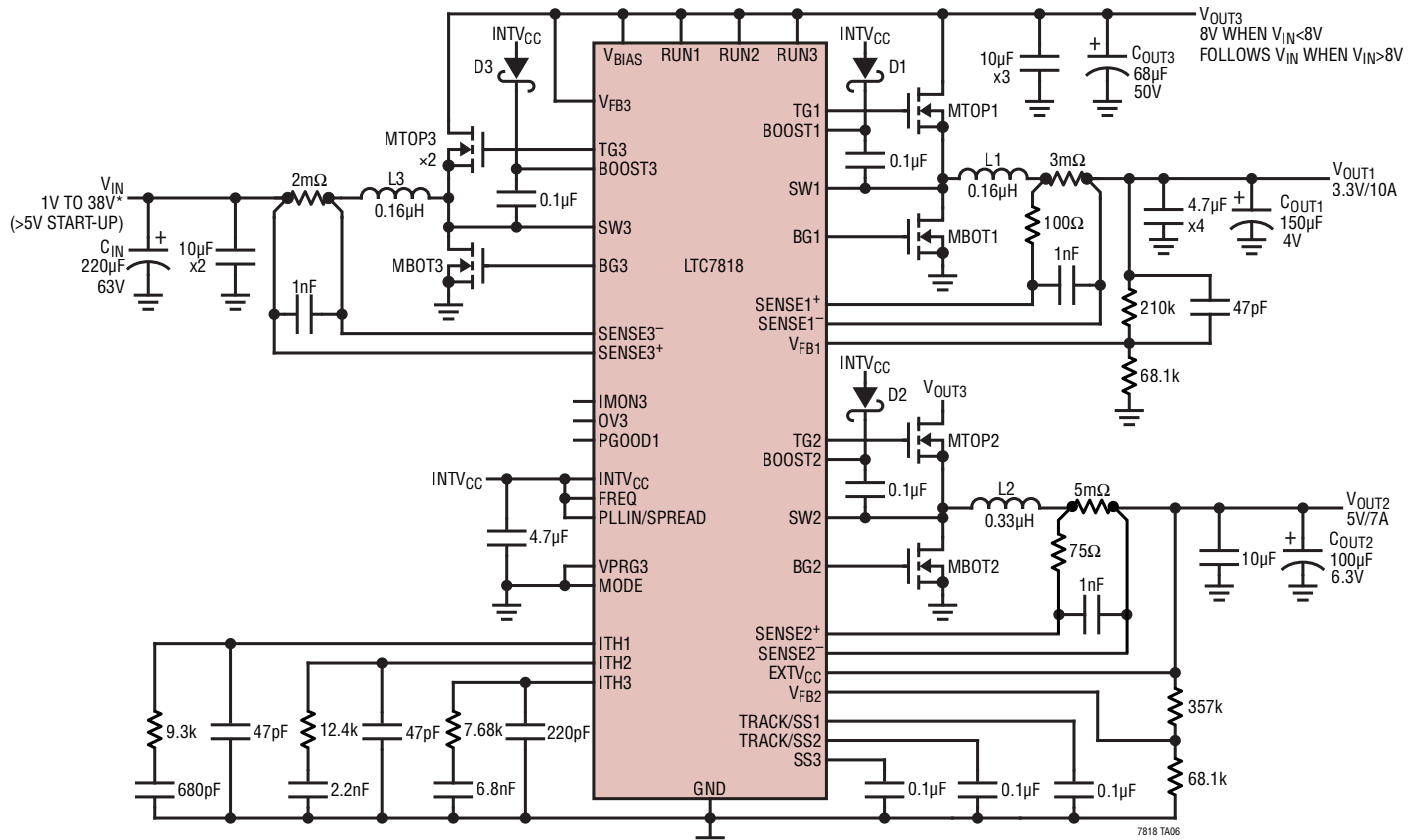

- MTOP1,2: INFINEON BSC093N04LS  
 MBOT1,2: INFINEON BSC093N04LS  
 MTOP3 (x2): INFINEON BSC027N04LS  
 MBOT3: INFINEON BSC059N04LS  
 L1,3: COILCRAFT XAL5030-161ME  
 L2: COILCRAFT XAL5030-331ME  
 D1,2,3: INFINEON BAS140WE6327HTSA1  
 CIN: SUNCON 63CE220LX  
 COUT1: KEMET T520B157M004ATE015  
 COUT2: KEMET T520B107M006APE070  
 COUT3: PANASONIC 50VSPF68M
- $f_{sw} = 2.25\text{MHz}$   
 \* WHEN  $V_{IN} < 4\text{V}$ , MAXIMUM COMBINED LOAD CURRENT AVAILABLE IS REDUCED  
 \* OUTPUT CURRENT CAPABILITY AT HIGH INPUT VOLTAGES MAY BE LIMITED BY THE THERMAL CHARACTERISTICS OF THE OVERALL SYSTEM AND PRINTED CIRCUIT BOARD DESIGN

(14a)

Efficiency and Power Loss vs Load Current

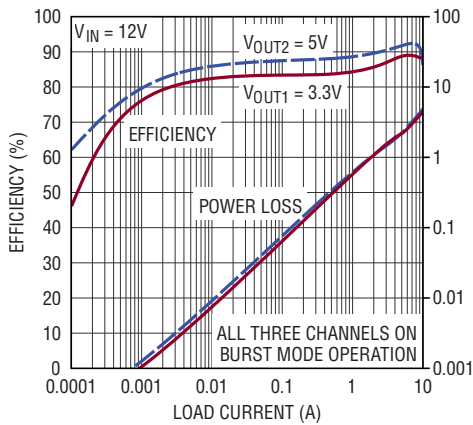

(14b)

VOUT1 Switch Node Waveform

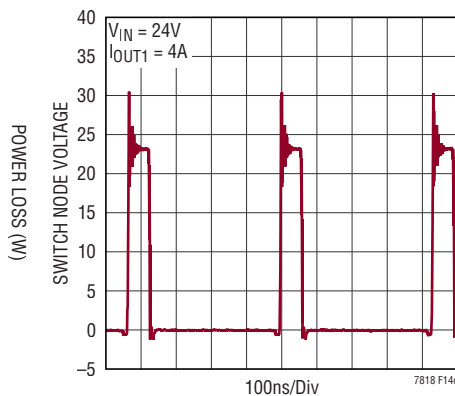

(14c)

Efficiency vs Input Voltage

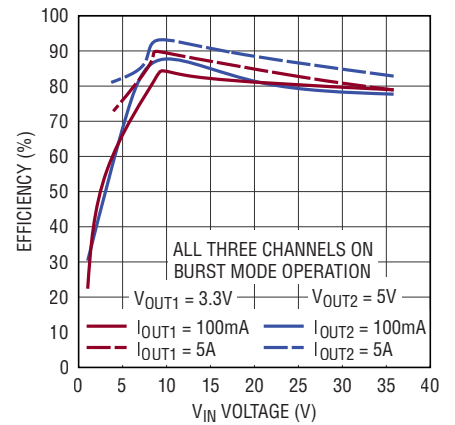

(14d)

Figure 14. High Efficiency Wide Input Range 2.25MHz Dual 5V/3.3V Regulator with Spread Spectrum

# PACKAGE DESCRIPTION

**UJ Package**  
**40-Lead Plastic QFN (6mm × 6mm)**  
 (Reference LTC DWG # 05-08-1728 Rev 0)

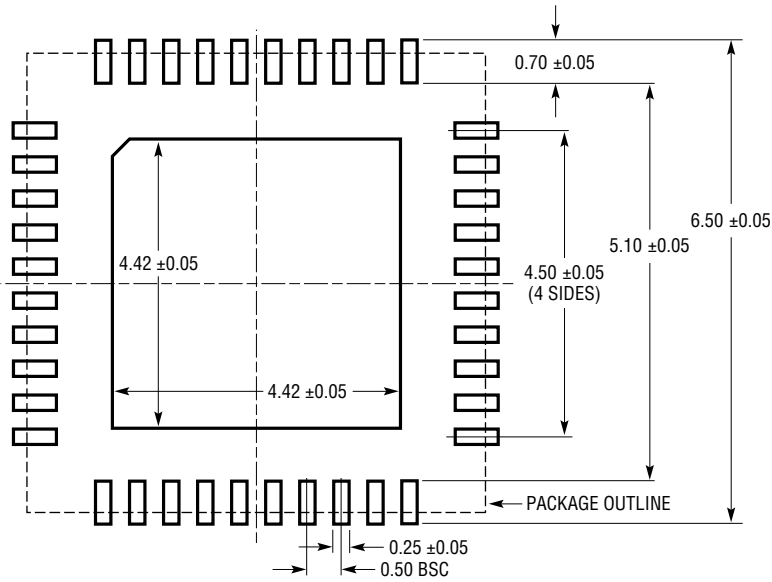

RECOMMENDED SOLDER PAD PITCH AND DIMENSIONS  
 APPLY SOLDER MASK TO AREAS THAT ARE NOT SOLDERED

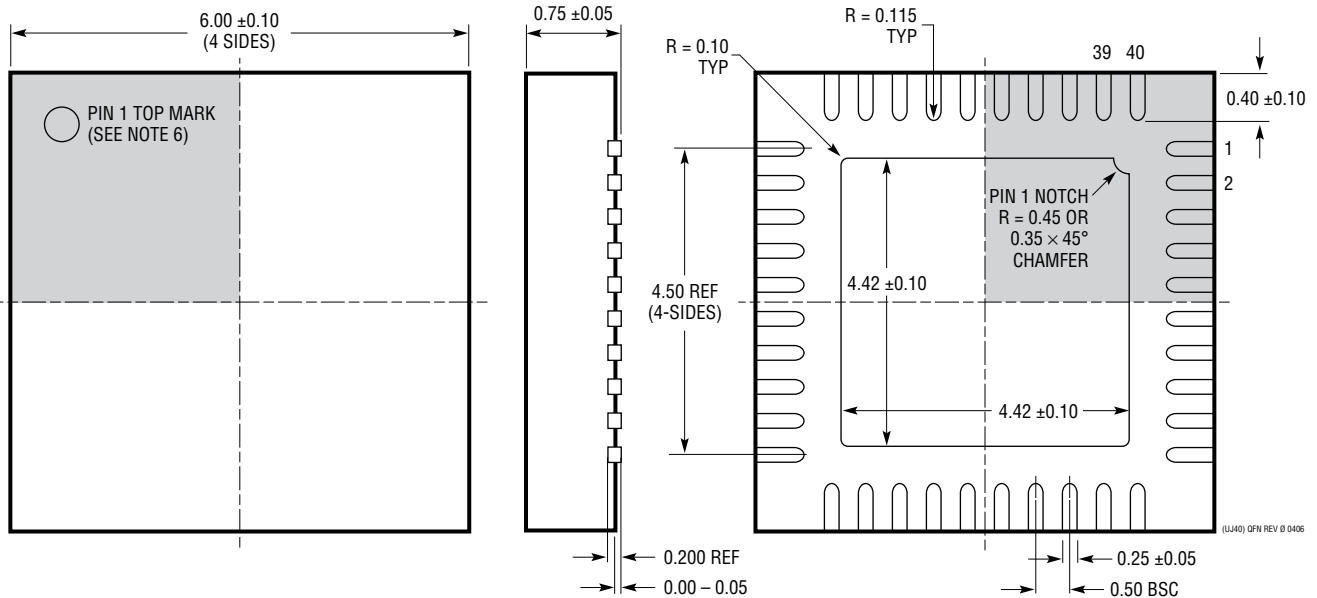

- NOTE:
1. DRAWING IS A JEDEC PACKAGE OUTLINE VARIATION OF (WJJD-2)
  2. DRAWING NOT TO SCALE
  3. ALL DIMENSIONS ARE IN MILLIMETERS
  4. DIMENSIONS OF EXPOSED PAD ON BOTTOM OF PACKAGE DO NOT INCLUDE MOLD FLASH. MOLD FLASH, IF PRESENT, SHALL NOT EXCEED 0.20mm ON ANY SIDE, IF PRESENT
  5. EXPOSED PAD SHALL BE SOLDER PLATED
  6. SHADED AREA IS ONLY A REFERENCE FOR PIN 1 LOCATION ON THE TOP AND BOTTOM OF PACKAGE

BOTTOM VIEW—EXPOSED PAD

(UJ40) QFN REV 0 0405

## REVISION HISTORY

REV	DATE	DESCRIPTION	PAGE NUMBER
A	06/20	Updated the following four graphs in the Typical Performance Characteristics section: V <sub>BIAS</sub> Quiescent Current vs Temperature Shutdown Current vs V <sub>BIAS</sub> Input Voltage BOOST3 Charge Pump Output Current vs Frequency BOOST3 Charge Pump Output Current vs SW3	10
		Updated Figure 2a	20
		Updated Figure 15	44
B	05/21	Added AEC-Q100 Qualified for Automotive Applications	1

## TYPICAL APPLICATION

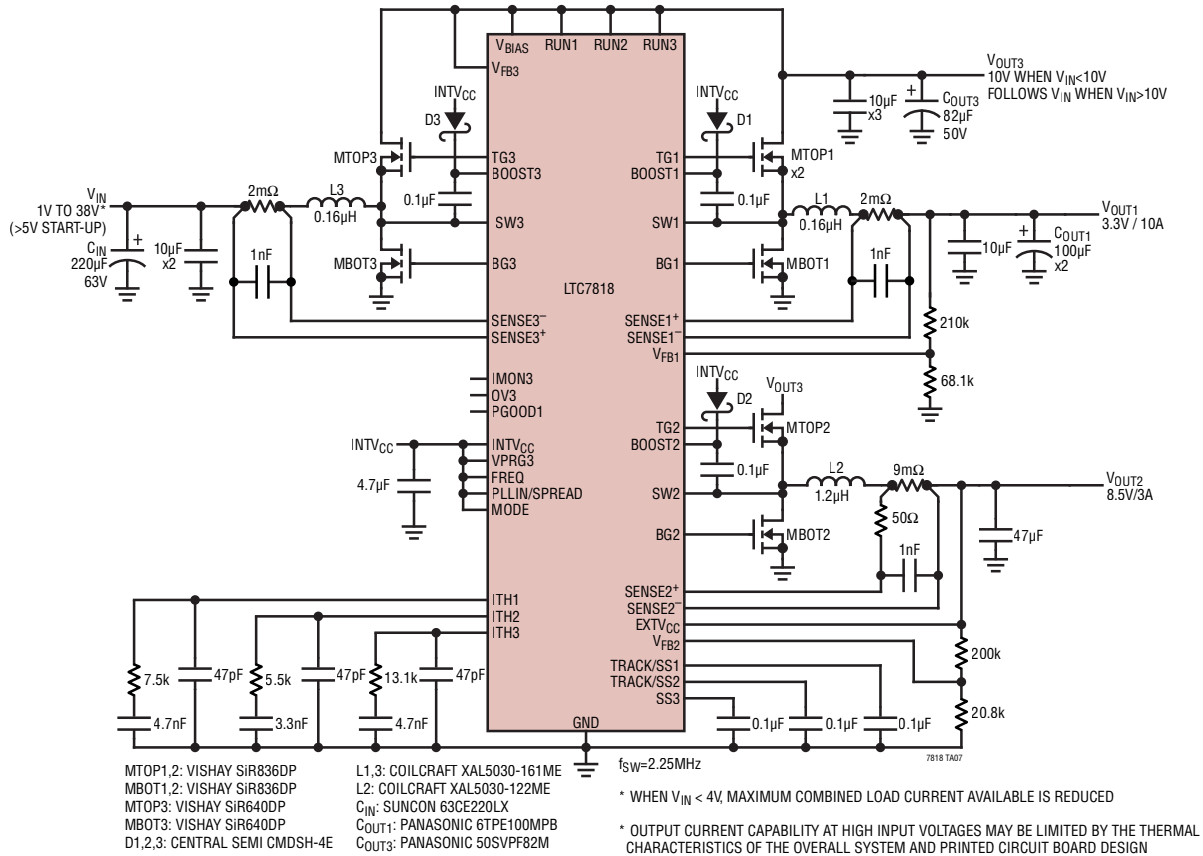

Figure 15. High Efficiency Wide Input Range 2.25MHz Dual 3.3V/8.5V Regulator with Spread Spectrum

## RELATED PARTS

PART NUMBER	DESCRIPTION	COMMENTS
<a href="#">LTC7802</a>	40V Dual Low $I_Q$ , 3MHz 2-Phase Synchronous Step-Down Controller with Spread Spectrum	$4.5\text{V} \leq V_{IN} \leq 40\text{V}$ , $V_{OUT}$ Up to 40V, $I_Q = 12\mu\text{A}$ Fixed Frequency 100kHz to 3MHz, 4mm X 5mm QFN-28
<a href="#">LTC7803</a>	40V Low $I_Q$ , 100% Duty Cycle, Synchronous Step-Down Controller with Spread Spectrum	$4.5\text{V} \leq V_{IN} \leq 40\text{V}$ , $V_{OUT}$ Up to 40V, $I_Q = 12\mu\text{A}$ Fixed Frequency 100kHz to 3MHz, 3mm x 3mm QFN-16/MSOP-16
<a href="#">LTC7804</a>	38V Low $I_Q$ , 3MHz Multiphase Synchronous Boost Controller with PassThru	$4.5\text{V} \leq V_{IN} \leq 38\text{V}$ , $V_{OUT}$ Up to 60V, 100kHz to 3MHz Fixed Operating Frequency, 3mm x 3mm QFN-16
<a href="#">LTC7815</a>	38V Low $I_Q$ , Triple Output, Buck/Buck/Boost Synchronous Controller PLL Fixed Operating Frequency 320kHz to 2.25MHz	$4.5\text{V}$ (Down to 2.5V After Start-Up) $\leq V_{IN} \leq 38\text{V}$ , $I_Q = 28\mu\text{A}$ Buck $V_{OUT}$ Range: 0.8V to 24V, Boost $V_{OUT}$ Up to 60V
<a href="#">LTC7817</a>	40V Low $I_Q$ , Triple Output, Buck/Buck/Boost Synchronous Controller PLL Fixed Operating Frequency 100kHz to 3MHz	$4.5\text{V}$ (Down to 2.5V After Start-Up) $\leq V_{IN} \leq 38\text{V}$ , $I_Q = 14\mu\text{A}$ Buck $V_{OUT}$ Range: 0.8V to 24V, Boost $V_{OUT}$ Up to 60V
<a href="#">LTC3859AL</a>	38V Low $I_Q$ , Triple Output, Buck/Buck/Boost Synchronous Controller PLL Fixed Operating Frequency 50kHz to 900kHz	$4.5\text{V}$ (Down to 1V After Start-Up) $\leq V_{IN} \leq 40\text{V}$ , $I_Q = 28\mu\text{A}$ Buck $V_{OUT}$ Range: 0.8V to 40V, Boost $V_{OUT}$ Up to 40V
<a href="#">LTC3899</a>	60V Low $I_Q$ , Triple Output, Buck/Buck/Boost Synchronous Controller PLL Fixed Operating Frequency 50kHz to 900kHz	$4.5\text{V}$ (Down to 2.2V After Start-Up) $\leq V_{IN} \leq 60\text{V}$ , $I_Q = 28\mu\text{A}$ Buck & Boost $V_{OUT}$ Up to 60V
<a href="#">LTC7800</a>	60V Low $I_Q$ , High Frequency Synchronous Step-Down Controller	$4\text{V} \leq V_{IN} \leq 60\text{V}$ , $0.8\text{V} \leq V_{OUT} \leq 24\text{V}$ , $I_Q = 50\mu\text{A}$ PLL Fixed Frequency 320kHz to 2.25MHz
<a href="#">LTC3892</a>	60V Low $I_Q$ , Dual 2-Phase Synchronous Step-Down Controller with Adjustable Gate Drive Voltage	$4.5\text{V} \leq V_{IN} \leq 60\text{V}$ , $0.8\text{V} \leq V_{OUT} \leq 0.99V_{IN}$ , $I_Q = 50\mu\text{A}$ PLL Fixed Frequency 50kHz to 900kHz