

300MHz to 3.5GHz Ultra-High Dynamic Range Downconverting Mixer

DESCRIPTION

Demonstration circuit 2035A features LTC[®]5551, which is a 300MHz to 3.5GHz ultra high dynamic range down converting mixer. Demo circuit 2035A is optimized for RF input frequency range 1.1GHz to 2.7GHz. IF output port is optimized for frequency range 116MHz to 250MHz. RF input can be matched with few external component for a wide range of frequencies. IF output port can be matched externally up to 500MHz. A typical application with low side LO injection provides the best performance for RF input frequency range 1.1GHz to 2.7GHz.

LTC5551 is optimized for 3.3V operation. A low power mode is available and is activated by pulling the ISEL pin high. This reduces the power consumption by 1/3, however reduces the IIP3 to approximately 29dBm.

Design files for this circuit board are available at <http://www.linear.com/demo/DC2035A>

LT, LT, LTC, LTM, Linear Technology and the Linear logo are registered trademarks of Linear Technology Corporation. All other trademarks are the property of their respective owners.

PERFORMANCE SUMMARY

Specifications are at $V_{CC} = 3.3V$, $V_{EN} = 3.3V$, $T_C = 25^\circ C$, $I_{SEL} = LOW$, $P_{LO} = 0dBm$, $P_{RF} = 0dBm$ ($\Delta f = 2MHz$, $0dBm/$ tone for two-tone IIP3 tests), unless otherwise noted. Test circuit shown in Schematic Diagram.

PARAMETER	CONDITION	TYP	UNITS
VCC Supply Voltage		2.5 to 3.6	V
VCC Supply Current	EN = High, with LO Signal Applied	204	mA
	EN = High, ISIL = HIGH, with LO Signal Applied	142	mA
Shutdown Current	EN = Low	<100	μA
EN Voltage	Low, Chip Disabled	<0.3	V
	HIGH, Chip Enabled	>1.2	V
EN Input Current	$V_{EN} = 0V$ to 3.3V	-30 to 100	μA
RF Input Frequency Range	LO Signal Applied, with External Match	1.1 to 2.7	GHz
RF Input Return Loss	LO Signal Applied	>10	dB
IF Output Frequency Range	LO Signal Applied, with External Match	116 to 250	MHz
IF Output Return Loss	LO Signal Applied	>10	dB
LO Frequency Range	With External Match	1.0 to 3.5	GHz
LO Input Return Loss	With External Match	>10	dB
LO Input Power	LO = 1000MHz to 3500MHz, with External LO Match	-6 to 6	dBm
LO to RF leakage	LO = 1000MHz to 3500MHz, with External LO Match	≤ 25	dBm
LO to IF leakage	LO = 1000MHz to 3500MHz, with External LO Match	≤ 21	dBm
RF to LO Isolation	RF = 1.1GHz to 2.7GHz, with External Match	>55	dB
RF to IF Isolation	RF = 1.1GHz to 2.7GHz, with External Match	>23	dB
1.1GHz to 2.7GHz Downmixer Application: IF = 153MHz, ISEL = Low, Unless Otherwise Noted.			
Power Conversion Gain	RF = 1100MHz, Low Side LO	2.5	dB
	RF = 1500MHz, Low Side LO	2.5	dB
	RF = 1950MHz, Low Side LO	2.4	dB
	RF = 2700MHz, Low Side LO	1.7	dB

DEMO MANUAL DC2035A

PERFORMANCE SUMMARY

Specifications are at $V_{CC} = 3.3V$, $EN = 3.3V$, $T_C = 25^\circ C$, $ISEL = LOW$, $P_{LO} = 0dBm$, $P_{RF} = 0dBm$ ($\Delta f = 2MHz$, $0dBm/$ tone for two-tone IIP3 tests), unless otherwise noted. Test circuit shown in Schematic Diagram.

PARAMETER	CONDITION	TYP	UNITS
2-Tone 3rd Order Intercept	RF = 1100MHz, Low Side LO	36.0	dBm
	RF = 1500MHz, Low Side LO	36.0	dBm
	RF = 1950MHz, Low Side LO	35.5	dBm
	RF = 2700MHz, Low Side LO	38.1	dBm
2-Tone Input 2nd Order Intercept ($\Delta f = 154MHz = f_{IM2}$)	RF = 1950MHz (2027MHz/1873MHz), LO = 1797MHz	58.4	dBm
SSB Noise Figure	RF = 1950MHz, Low Side LO	9.7	dB
Input 1dB Compression	RF = 1950MHz, Low Side LO	18	dBm
Low Power Mode, IF = 153MHz, ISEL = High			
Power Conversion Gain	RF = 1950MHz, Low Side LO	2.4	dB
Input 3rd Order Intercept	RF = 1950MHz, Low Side LO	29.3	dBm
SSB Noise Figure	RF = 1950MHz, Low Side LO	8.3	dB
Input 1dB Compression	RF = 1950MHz, Low Side LO	16.7	dBm

DETAILED DESCRIPTION

Absolute Maximum Ratings

Note: Stresses beyond absolute maximum ratings may cause permanent damage to the device. Exposure to any absolute maximum rating conditions for extended periods may affect the device reliability and lifetime.

Supply Voltage (V_{CC} , IF^+ , IF^-)	4V
Enable Input Voltage (EN)	-0.3V to $V_{CC} + 0.3V$
Power Select Voltage (ISEL)	-0.3V to $V_{CC} + 0.3V$
LO Input Power (0.2GHz to 3.5GHz)	+10dBm
LO Input DC Voltage	$\pm 0.1V$
RF Input Power (0.3GHz to 3.5GHz)	+20dBm
RF Input DC Voltage	$\pm 0.1V$
Temp Diode Continuous DC input Current	10mA
Temp Diode Input Voltage	$\pm 1V$
IFBIAS Voltage	2.5V
Operating Temperature Range (T_C)	-40°C to 105°C

Supply Voltage Ramping

Fast ramping of the supply voltage can cause current glitch in the internal ESD protection circuits. Depending on supply leads inductance, this could result in a supply voltage transient that exceeds the maximum rating. A supply voltage ramp time of greater than 1ms is recommended.

Supply leads used to power the demo board should be as short as possible to minimize the lead inductance and resistance. During power-up, connect the power leads to the demo board before turning on the power supply. Supply voltage should be ramped up slowly to 3.3V to avoid any overshoot transients which may damage the IC.

Enable Feature

To enable the chip, EN voltage must be greater than 1.2V. However, EN voltage must not exceed V_{CC} by more than 0.3V to avoid permanent damage to the chip. When EN is left floating, the voltage will be pulled low by the internal pull-down resistor, and the chip will be disabled.

Low Power Mode

The LTC5551 can be set to low power mode using a digital voltage applied to ISEL. This allows flexibility to choose a reduced current of operation when lower RF performance is acceptable. When ISEL is set to low (<0.3V), the mixer operate at nominal DC current. When ISEL is set to high (>1.2V), DC current consumption is reduced resulting in lower RF performance. When ISEL is left floating, ISEL is pulled down to low voltage by the internal pull down resistor.

DETAILED DESCRIPTION

Temperature Diode

The LTC5551 provides an on-chip diode connected to TEMP on the demo board. TEMP is connected to the anode of the internal ESD diode. The junction temperature can be measured by injecting a 10 μ A current into TEMP pin. The voltage vs temperature coefficient of the diode is about $-1.72\text{mV}/^\circ\text{C}$ with 10 μ A current injected into the TEMP pin.

RF Input

The RF input of DC2035A is externally matched from 1100MHz to 2700MHz, with return loss greater than 10dB. However, the RF input match can be shifted down to 300MHz, or up to 3500MHz by replacing the external matching components, see Table 1. A series DC blocking capacitor must be used if DC voltage is present at the RF input to avoid damage to the internal input transformer.

RF Input Return Loss (with LO Signal Applied)

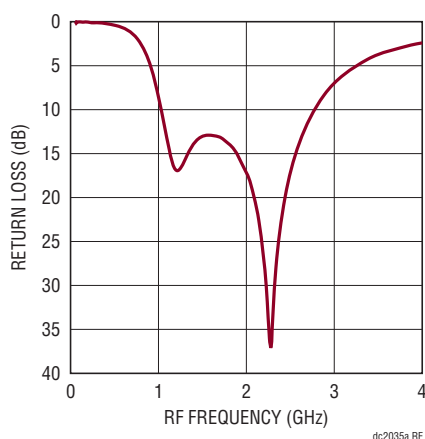

LO Input

The LO input on DC2035A is externally matched from 1000MHz to 3500MHz with series 3.9pF capacitor. Matching below 1000MHz can be accomplished by adding a shunt component at C3, see Table 1. A series DC blocking capacitor must be used to avoid damage to the integrated transformer if DC voltage is present at the LO input.

LO Input Return Loss

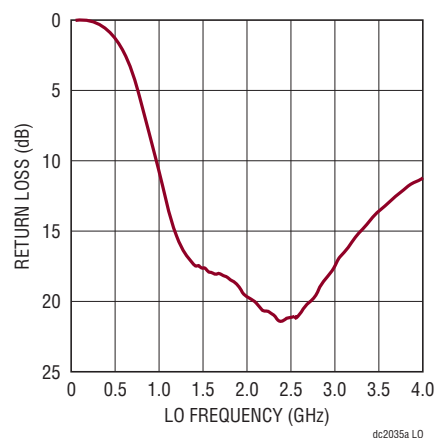

IF Output

IF output port can be matched for IF frequencies as low as 5MHz, and as high as 500MHz. Standard demo board is matched for center frequency 153MHz. Other frequencies can be matched by changing the values of L1, and L2. See table below for inductor values for other IF frequencies.

Table 1. Matching Values at Other Frequencies (See Schematic Diagram)

APPLICATION		RF MATCH			LO MATCH		IF TRANSFORMER	
RF (MHz)	LO	X1	C1	X2	C2	C3	T1	VENDOR
300 to 650	HS	15nH	15pF	15pF	15pF	8.2pF	TC4-1W-7ALN+	Mini-Circuit
500 to 1100	HS	13nH	6.8pF	4.7pF	8.2pF	2.2pF	WBC4-6TLB	Coilcraft
1100 to 2700	LS, HS	7.5nH	2.2pF	–	3.9pF	–	TC4-1W-7ALN+	Mini-Circuit
2300 to 3500	LS, HS	1.2pF	22pF	2.2nH	3.9pF	–	TC4-1W-7ALN+	Mini-Circuit

DETAILED DESCRIPTION

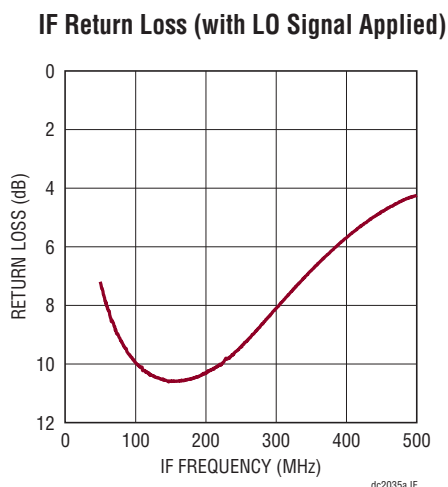

Table 2. Inductor Matching Values vs IF Frequencies

L1, L2 vs IF Frequencies		
IF (MHz)	L1, L2 (nH)	COMMENTS
120	820	Coilcraft 0603 LS
153	470	Coilcraft 0603 LS
240	180	Coilcraft 0603 LS
305	120	Coilcraft 0603 LS
380	56	Coilcraft 0603 LS
456	33	Coilcraft 0603 LS

QUICK START PROCEDURE

Demonstration circuit 2035A is easy to set up to evaluate the performance of the LTC5551. Refer to Figures 1 to 3 for proper equipment connections and follow the procedures below:

Note: Care should be taken to never exceed absolute maximum input ratings. Make all connections with RF and DC power off.

Return Loss Measurements

1. Configure the network analyzer for return loss measurement, set appropriate frequency range, and set the test signal to 0dBm.
2. Calibrate the network analyzer.
3. Connect all test equipment as shown in Figure 1 with the signal generator and the DC power supply turned off.
4. Ramp up VCC supply voltage to 3.3V, and verify that the current consumption is approximately 204mA with LO signal applied and ISEL set to Low. The correct supply voltage should be confirmed, measured at the demo board to account for the voltage drop across supply leads.
5. Set the LO source to provide a 0dBm, CW signal to the demo board LO input port at appropriate LO frequency.

6. With the LO signal applied, and the unused demo board ports terminated in 50Ω, measure return losses of the RF input and IF output ports.
7. Terminate the RF input and the IF output ports in 50Ω. Measure return loss of the LO input port.

RF Performance Measurements

1. Connect all test equipment as shown in Figure 2 with the signal generators and the DC power supply turned off.
2. Ramp up the VCC supply voltage to 3.3V, and verify that the current consumption is approximately 204mA with LO signal applied. The supply voltage should be confirmed at the demo board VCC and GND terminals to account for the voltage drop across wire leads.
3. Set the LO source signal generator to provide 0dBm, CW signal to the demo board LO input port at the appropriate LO frequency.
4. Set the RF sources, to provide the two tone inputs at 0dBm per tone, CW signal 2MHz apart to the demo board RF input port at the appropriate RF frequency.
5. Measure the resulting IF output on the spectrum analyzer:

QUICK START PROCEDURE

- a. Measure The wanted two-tone IF output signals are located at:

Low Side LO:

$$f_{IF1} = f_{RF1} - f_{LO},$$

$$f_{IF2} = f_{RF2} - f_{LO}$$

High Side LO:

$$f_{IF1} = f_{LO} - f_{RF1},$$

$$f_{IF2} = f_{LO} - f_{RF2}$$

- b. The 3rd order intermodulation products which are closest to the wanted IF signals are used to calculate the input 3rd order intercept, where $\Delta IF = f_{IF2} - f_{IF1}$:

$$f_{IM3,1} = f_{IF1} - \Delta IF$$

$$f_{IM3,2} = f_{IF2} + \Delta IF$$

- b. Calculate the input 3rd order intercept:

$$IIP3 = (\Delta_{IM3})/2 + P_{RF}$$

Where $\Delta_{IM3} = P_{IF} - P_{IM3}$

6. Turn off one of the RF signal generators, and measure conversion gain, RF to IF isolation, LO to IF leakage, and input 1dB compression point.

Noise Figure Measurements

1. Configure and calibrate the noise figure meter for mixer measurements.
2. Connect all test equipment as shown in Figure 3 with signal generator and DC power supply turned off.
3. Increase VCC supply voltage to 3.3V, and verify that the current consumption is approximately 204mA with LO signal applied. The supply voltage should be confirmed at the demo board VCC and GND terminals to account for voltage drop across supply leads.
4. Set LO source to provide a 0dBm, CW signal to the demo board LO input port at appropriate LO frequency.
5. Measure the single-sideband noise figure.

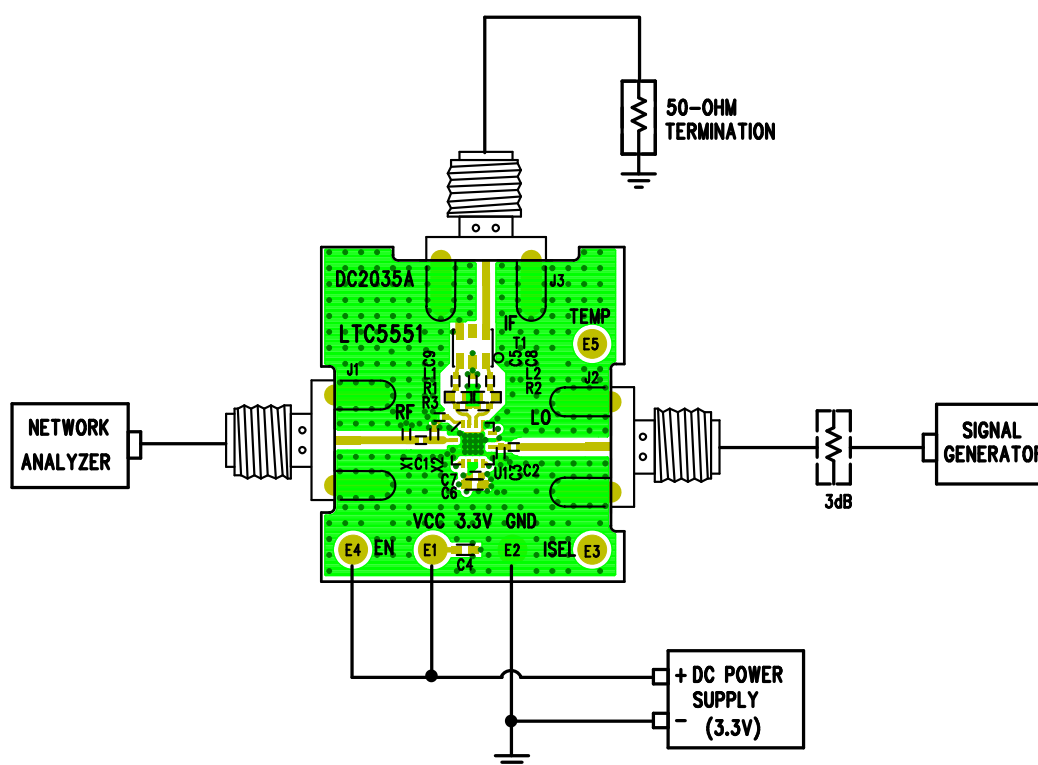

Figure 1. Proper Equipment Setup for Return Loss Measurements

HARDWARE SETUP

LTC5551 is an ultrahigh dynamic range downconverting mixer with very high input third order intercept point. Accuracy of its performance measurement is highly dependent on equipment setup and measurement technique. The recommended setups are presents in the following pages. The following precautions should be observed:

1. Use high performance signal generators with low harmonic output and low phase noise, such as Rohde & Schwarz SME06 or equivalent. Filter may be used at the signal generators to suppress higher order harmonics. For example, when measuring 2nd order product spurs.
2. A high quality RF power combiner that provide broadband 50Ω termination on all ports, and have excellent port-to-port isolation must be used to get the best RF performance, such as MCLI PS2-17.
3. High performance amplifiers with high IP3 is recommended at the inputs to improve the isolation when performing the two-tone measurements. High isolation minimizes the modulation of the two sources, thus improving the source IP3.
4. Use attenuator pads with good broadband VSWR on the demonstration board's input and output ports. They provide the improved return loss that can reduce the interstage reflections which can degrade RF performance.
5. Use a high dynamic range spectrum analyzer such as FSEM 30 for linearity measurements.
6. Use narrow resolution bandwidth (RBW) and engage video averaging on the spectrum analyzer to lower displayed average noise level (DANL) in order to improve sensitivity and to increase dynamic range. However, the trade off is increased sweep time.
7. Spectrum analyzer produces its own nonlinearity when overdriven. Generally, 30dB of input attenuation is sufficient for linearity measurements. Appropriate amount of attenuation should be used so that the spectrum analyzer nonlinearity does not degrade the device under test (DUT) RF performance. However, using too much input attenuation will result is higher noise level, and decreased dynamic range.
8. Before starting any RF measurements, the input signal must be calibrated. The input signal IP3 must be verified to be much better than the DUT so that the measurement equipment does not degrade the overall RF measurement result.

P1dB Compression Measurement

Figure 2 can be modified for the P1dB compression measurement. Turn off one of the input signal generators, sweep the input power so that LTC5551 conversion gain is reduced by 1dB. The input power at which conversion gain is reduced by 1dB is the Input referred 1dB compression point. However, signal generators and amplifiers at the input also introduce additional compression into the signal path. Therefore, the 6dB pad after the combiner is removed for this test so that LTC5551's compression point is accurately measured.

PCB LAYOUT

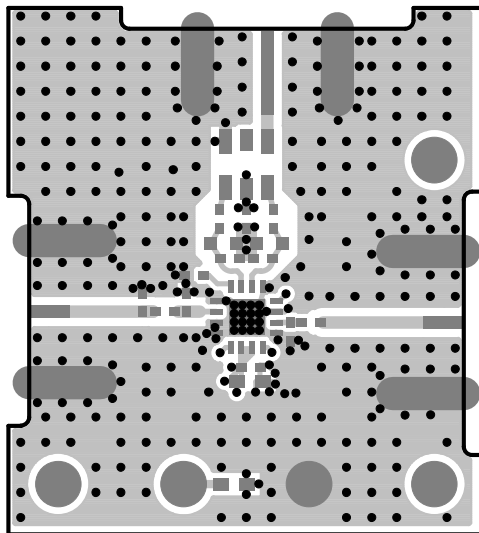

LAYER 1 : TOP LAYER
LINEAR TECHNOLOGY DATE: 04-24-13
DC2035A-2 * LTC5551IUF
DOWNCONVERTING MIXER 300MHz-3.5GHz

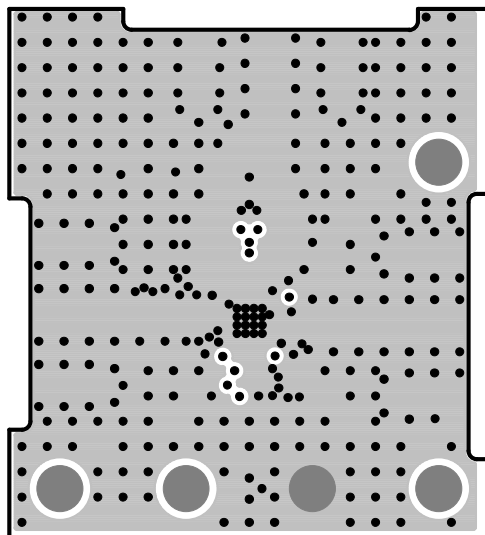

LAYER 2 : - PLANE 1- GND
LINEAR TECHNOLOGY DATE: 04-24-13
DC2035A-2 * LTC5551IUF
DOWNCONVERTING MIXER 300MHz-3.5GHz

PCB LAYOUT

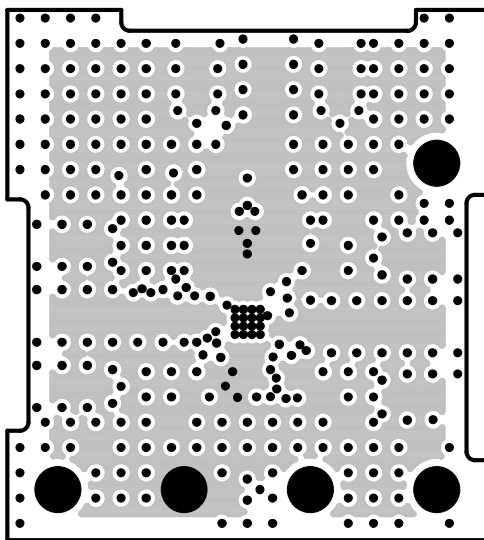

LAYER 3 : - PLANE 2 - PWR

LINEAR TECHNOLOGY DATE: 04-24-13

DC2035A-2 * LTC5551IUF

DOWNCONVERTING MIXER 300MHz-3.5GHz

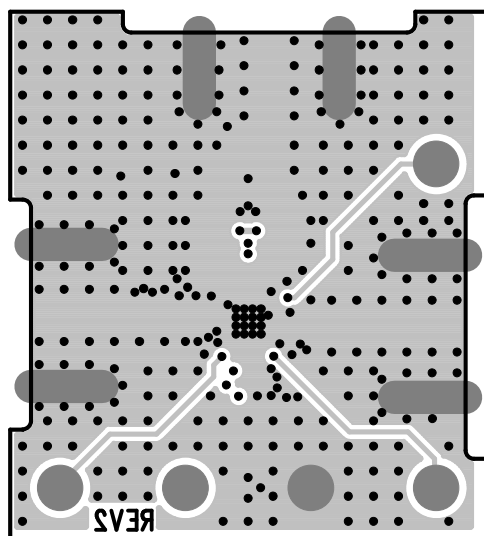

LAYER 4-BOTTOM LAYER

LINEAR TECHNOLOGY DATE: 04-24-13

DC2035A-2 * LTC5551IUF

DOWNCONVERTING MIXER 300MHz-3.5GHz

DEMO MANUAL DC2035A

PARTS LIST

ITEM	QTY	REFERENCE	PART DESCRIPTION	MANUFACTURER/PART NUMBER
Required Circuit Components				
1	1	C1	CAP., COG, 2.2pF, ±0.1pF, 50V, 0402	AVX, 04025A2R2BAT2
2	1	C2	CAP., COG, 3.9pF, ±0.1%, 50V, 0402	AVX, 04025A3R9BAT2A
3	0	X2, R3, C3	0402, OPT	
4	2	C4, C6	CAP., 0.56µF, 10%, 10V, X5R, 0603	AVX, 0603ZD564KAT2A
5	2	C5, C7	CAP., 22pF, 50V, 5%, NPO, 50V, 0402	AVX, 04025A220JAT2A
6	2	C8, C9	CAP., X7R, 1000pF, 10%, 50V, 0402	AVX, 04025C102KAT2A
7	5	E1-E5	TURRET, PAD 0.061"	MILL-MAX, 2308-2-00-80-00-00-07-0
8	1	J1-J3	CONN., SMA 50Ω EDGE-LAUNCH	E. F. JOHNSON, 142-0701-851
9	2	L1, L2	IND., WIRE-WOUND, 470nH, 2%, 0603	COILCRAFT, 0603LS-471XGLB
10	1	X1	IND., WIRE-WOUND, 7.5nH, 0402	COILCRAFT, 0402hp-7N5XJL
11	2	R1, R2	RES., CHIP, 475Ω, 1%, 0402	VISHAY, CRCW0402475RFKED
12	1	T1	TRANSFORMER, SMT, RF WIDEBAND, 4:1	MINI-CIRCUITS, TC4-1W-7ALN+
13	1	U1	IC., LINEAR TECHNOLOGY, LTC5551IUF	LINEAR TECH., LTC5551IUF

SCHEMATIC DIAGRAM

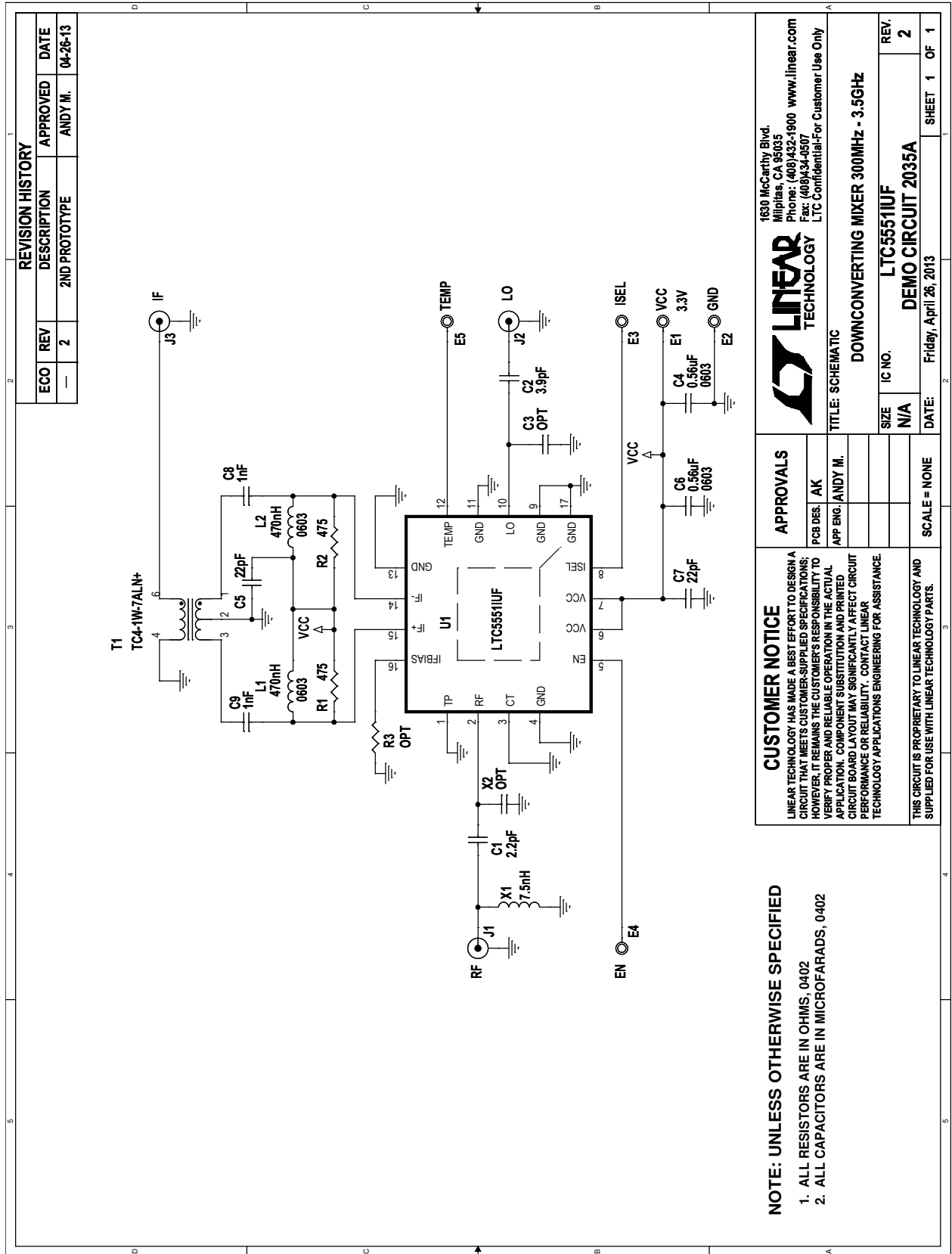

REVISION HISTORY				
ECO	REV	DESCRIPTION	APPROVED	DATE
—	2	2ND PROTOTYPE	ANDY M.	04-26-13

		1630 McCarthy Blvd. Milpitas, CA 95035 Phone: (408) 332-1900 www.linear.com Fax: (408) 334-0507 LTC Confidential-For Customer Use Only	
TITLE: SCHEMATIC			
DOWNCONVERTING MIXER 300MHz - 3.5GHz			
SIZE	IC NO.	REV.	
N/A	LTC5551UUF	2	
DATE:	Friday, April 26, 2013		SHEET 1 OF 1

CUSTOMER NOTICE LINEAR TECHNOLOGY HAS MADE A BEST EFFORT TO DESIGN A CIRCUIT THAT MEETS CUSTOMER-SUPPLIED SPECIFICATIONS; HOWEVER, IT REMAINS THE CUSTOMER'S RESPONSIBILITY TO VERIFY PROPER AND RELIABLE OPERATION IN THE ACTUAL APPLICATION. COMPONENT SUBSTITUTION AND PRINTED CIRCUIT BOARD LAYOUT MAY SIGNIFICANTLY AFFECT CIRCUIT PERFORMANCE OR RELIABILITY. CONTACT LINEAR TECHNOLOGY APPLICATIONS ENGINEERING FOR ASSISTANCE.	APPROVALS
	PCB DES: AK APP ENG: ANDY M. SCALE = NONE

NOTE: UNLESS OTHERWISE SPECIFIED

1. ALL RESISTORS ARE IN OHMS, 0402
2. ALL CAPACITORS ARE IN MICROFARADS, 0402

DEMO MANUAL DC2035A

DEMONSTRATION BOARD IMPORTANT NOTICE

Linear Technology Corporation (LTC) provides the enclosed product(s) under the following **AS IS** conditions:

This demonstration board (DEMO BOARD) kit being sold or provided by Linear Technology is intended for use for **ENGINEERING DEVELOPMENT OR EVALUATION PURPOSES ONLY** and is not provided by LTC for commercial use. As such, the DEMO BOARD herein may not be complete in terms of required design-, marketing-, and/or manufacturing-related protective considerations, including but not limited to product safety measures typically found in finished commercial goods. As a prototype, this product does not fall within the scope of the European Union directive on electromagnetic compatibility and therefore may or may not meet the technical requirements of the directive, or other regulations.

If this evaluation kit does not meet the specifications recited in the DEMO BOARD manual the kit may be returned within 30 days from the date of delivery for a full refund. **THE FOREGOING WARRANTY IS THE EXCLUSIVE WARRANTY MADE BY THE SELLER TO BUYER AND IS IN LIEU OF ALL OTHER WARRANTIES, EXPRESSED, IMPLIED, OR STATUTORY, INCLUDING ANY WARRANTY OF MERCHANTABILITY OR FITNESS FOR ANY PARTICULAR PURPOSE. EXCEPT TO THE EXTENT OF THIS INDEMNITY, NEITHER PARTY SHALL BE LIABLE TO THE OTHER FOR ANY INDIRECT, SPECIAL, INCIDENTAL, OR CONSEQUENTIAL DAMAGES.**

The user assumes all responsibility and liability for proper and safe handling of the goods. Further, the user releases LTC from all claims arising from the handling or use of the goods. Due to the open construction of the product, it is the user's responsibility to take any and all appropriate precautions with regard to electrostatic discharge. Also be aware that the products herein may not be regulatory compliant or agency certified (FCC, UL, CE, etc.).

No License is granted under any patent right or other intellectual property whatsoever. **LTC assumes no liability for applications assistance, customer product design, software performance, or infringement of patents or any other intellectual property rights of any kind.**

LTC currently services a variety of customers for products around the world, and therefore this transaction **is not exclusive**.

Please read the DEMO BOARD manual prior to handling the product. Persons handling this product must have electronics training and observe good laboratory practice standards. **Common sense is encouraged.**

This notice contains important safety information about temperatures and voltages. For further safety concerns, please contact a LTC application engineer.

Mailing Address:

Linear Technology
1630 McCarthy Blvd.
Milpitas, CA 95035

Copyright © 2004, Linear Technology Corporation