

High frequency secondary rectifier

Datasheet - production data

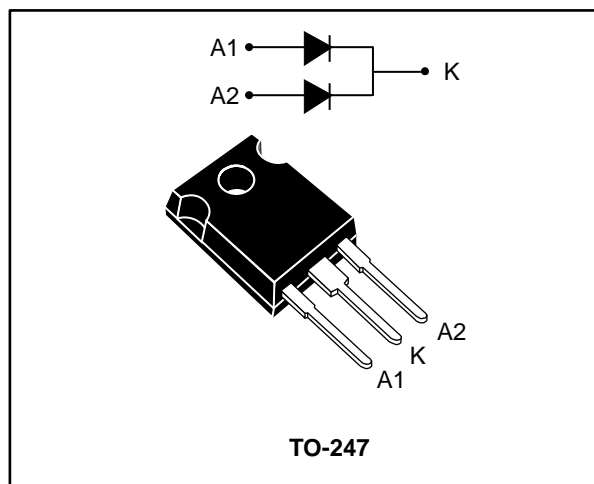

Description

Dual rectifier suited for switch mode power supply and high frequency DC to DC converters. Packaged in TO-247, this device is intended for use in low voltage, high frequency inverters, free wheeling operation, welding equipment and telecom power supplies.

Table 1: Device summary

Symbol	Value
$I_{F(AV)}$	2 x 30 A
V_{RRM}	300 V
V_F (max.)	1 V
t_{rr} (max.)	55 ns

Features

- Combines highest recovery and voltage performance
- Ultrafast, soft and noise-free recovery
- Low inductance and low capacitance allow simplified layout

1 Characteristics

Table 2: Absolute ratings (limiting values at 25 °C, unless otherwise specified)

Symbol	Parameter		Value	Unit	
V _{RRM}	Repetitive peak reverse voltage		300	V	
I _{F(RMS)}	Forward rms current		60	A	
I _{F(AV)}	Average forward current δ = 0.5, square wave	T _c = 135 °C	Per diode	30	A
			Per device	60	
I _{FSM}	Surge non repetitive forward current	t _p = 10 ms sinusoidal	300	A	
I _{RSM}	Non repetitive peak reverse current	t _p = 100 μs square	4	A	
T _{stg}	Storage temperature range		-65 to +175	°C	
T _j	Maximum operating junction temperature		+175	°C	

Table 3: Thermal parameters

Symbol	Parameter		Maximum	Unit
R _{th(j-c)}	Junction to case	Per diode	1	°C/W
		Total	0.55	
R _{th(c)}	Coupling		0.1	

When the diodes 1 and 2 are used simultaneously:

$$\Delta T_j (\text{diode1}) = P_{(\text{diode1})} \times R_{\text{th(j-c)}(\text{per diode})} + P_{(\text{diode2})} \times R_{\text{th(c)}}$$

Table 4: Static electrical characteristics

Symbol	Parameter	Test conditions		Min.	Typ.	Max.	Unit
I _R ⁽¹⁾	Reverse leakage current	T _j = 25 °C	V _R = 300 V	-		60	μA
		T _j = 125 °C		-	60	600	
V _F ⁽²⁾	Forward voltage drop	T _j = 25 °C	I _F = 30 A	-		1.25	V
		T _j = 125 °C		-	0.85	1	

Notes:

(1)Pulse test: t_p = 5 ms, δ < 2 %

(2)Pulse test: t_p = 380 μs, δ < 2 %

To evaluate the maximum conduction losses, use the following equation:

$$P = 0.75 \times I_{F(AV)} + 0.008 \times I_{F(RMS)}^2$$

Table 5: Dynamic characteristics

Symbol	Parameters	Test conditions		Min.	Typ.	Max.	Unit
t_{rr}	Reverse recovery time	$T_j = 25\text{ °C}$	$I_F = 0.5\text{ A};$ $I_{rr} = 0.25\text{ A},$ $I_R = 1\text{ A}$	-		40	ns
			$I_F = 1\text{ A},$ $di_F/dt = -50\text{ A}/\mu\text{s},$ $V_R = 30\text{ V}$	-		55	
t_{fr}	Forward recovery time	$T_j = 25\text{ °C}$	$I_F = 30\text{ A};$ $di_F/dt = 200\text{ A}/\mu\text{s},$ $V_{FR} = 1.1 \times V_{F\text{ max.}}$	-		350	ns
V_{FP}	Forward recovery voltage			-		5	V
S_{factor}	Softness factor	$T_j = 125\text{ °C}$	$V_{CC} = 200\text{ V},$ $I_F = 30\text{ A},$ $di_F/dt = 200\text{ A}/\mu\text{s}$	-	0.3		-
I_{RM}	Reverse recovery current			-		11	A

1.1 Characteristics (curves)

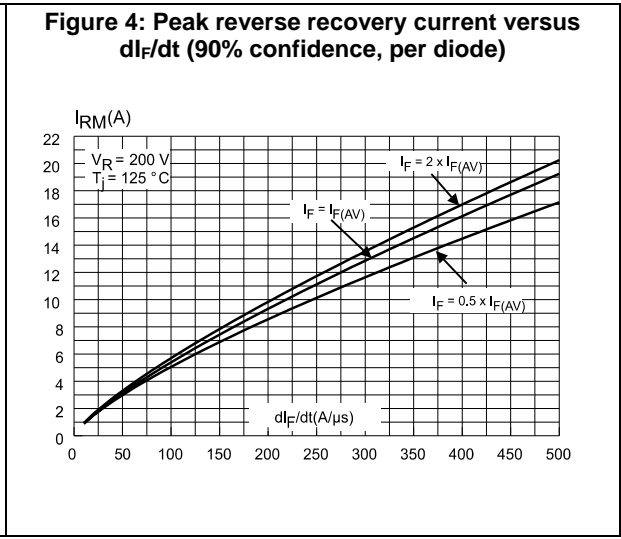
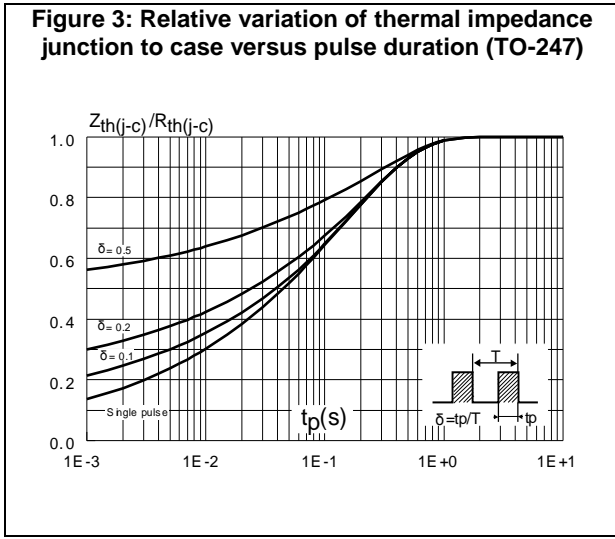
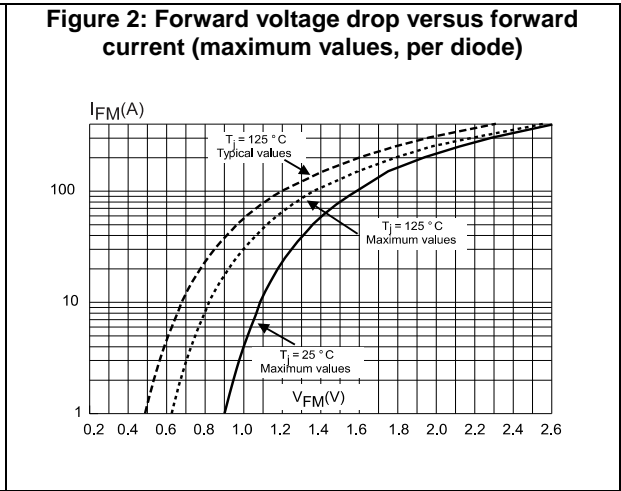
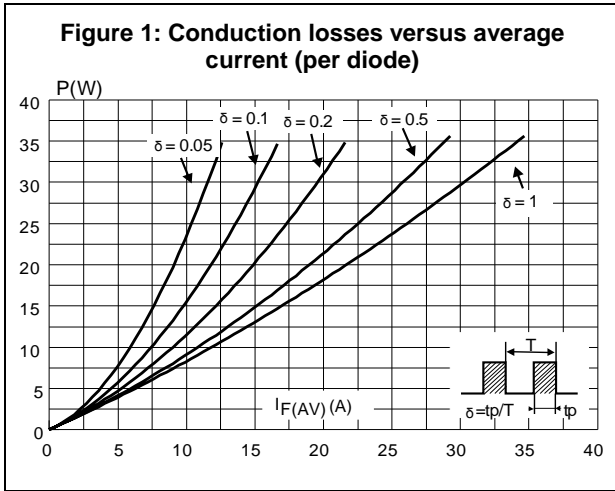

Figure 5: Reverse recovery time versus di_F/dt (90% confidence, per diode)

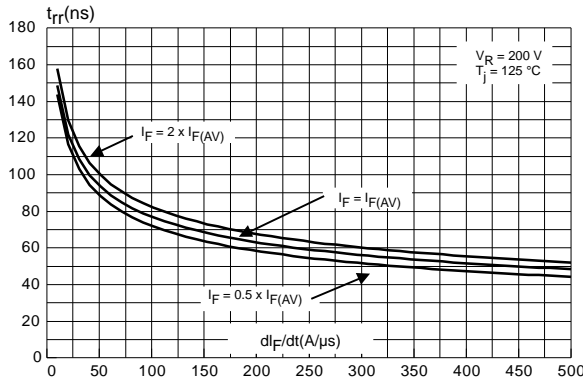

Figure 6: Softness factor (tb/ta) versus di_F/dt (typical values, per diode)

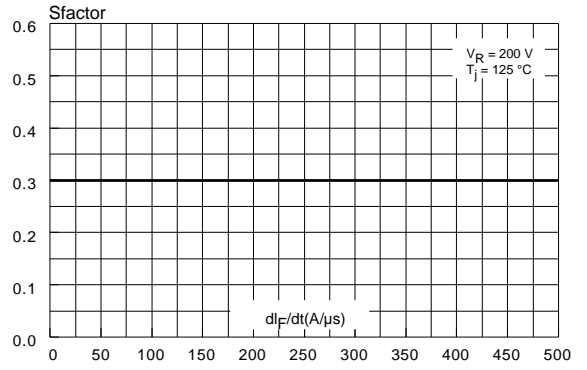

Figure 7: Relative variation of dynamic parameters versus junction temperature ($T_j = 125$ °C)

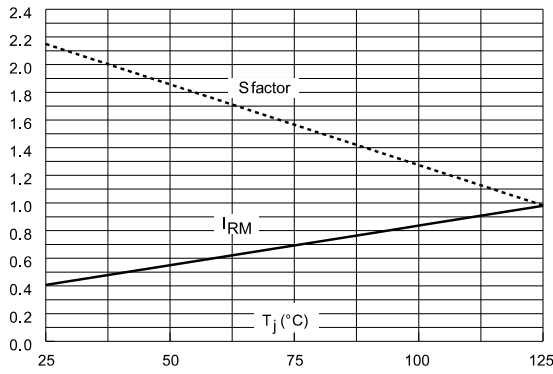

Figure 8: Transient peak forward voltage versus di_F/dt (90% confidence, per diode)

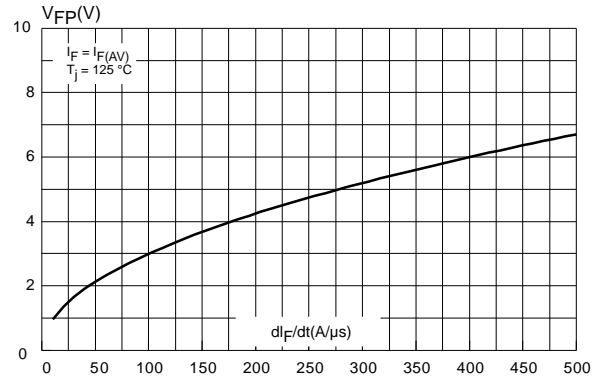
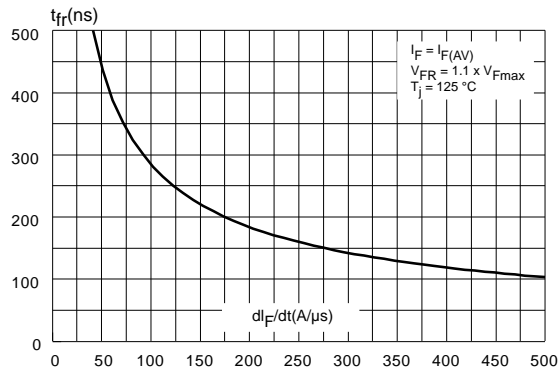

Figure 9: Forward recovery time versus di_F/dt (90% confidence, per diode)



2 Package information

In order to meet environmental requirements, ST offers these devices in different grades of ECOPACK® packages, depending on their level of environmental compliance. ECOPACK® specifications, grade definitions and product status are available at: www.st.com. ECOPACK® is an ST trademark.

- Epoxy meets UL94, V0
- Cooling method: by conduction (C)
- Recommended torque values: 0.55 N·m
- Maximum torque value: 1.0 N·m

2.1 TO-247 package information

Figure 10: TO-247 package outline

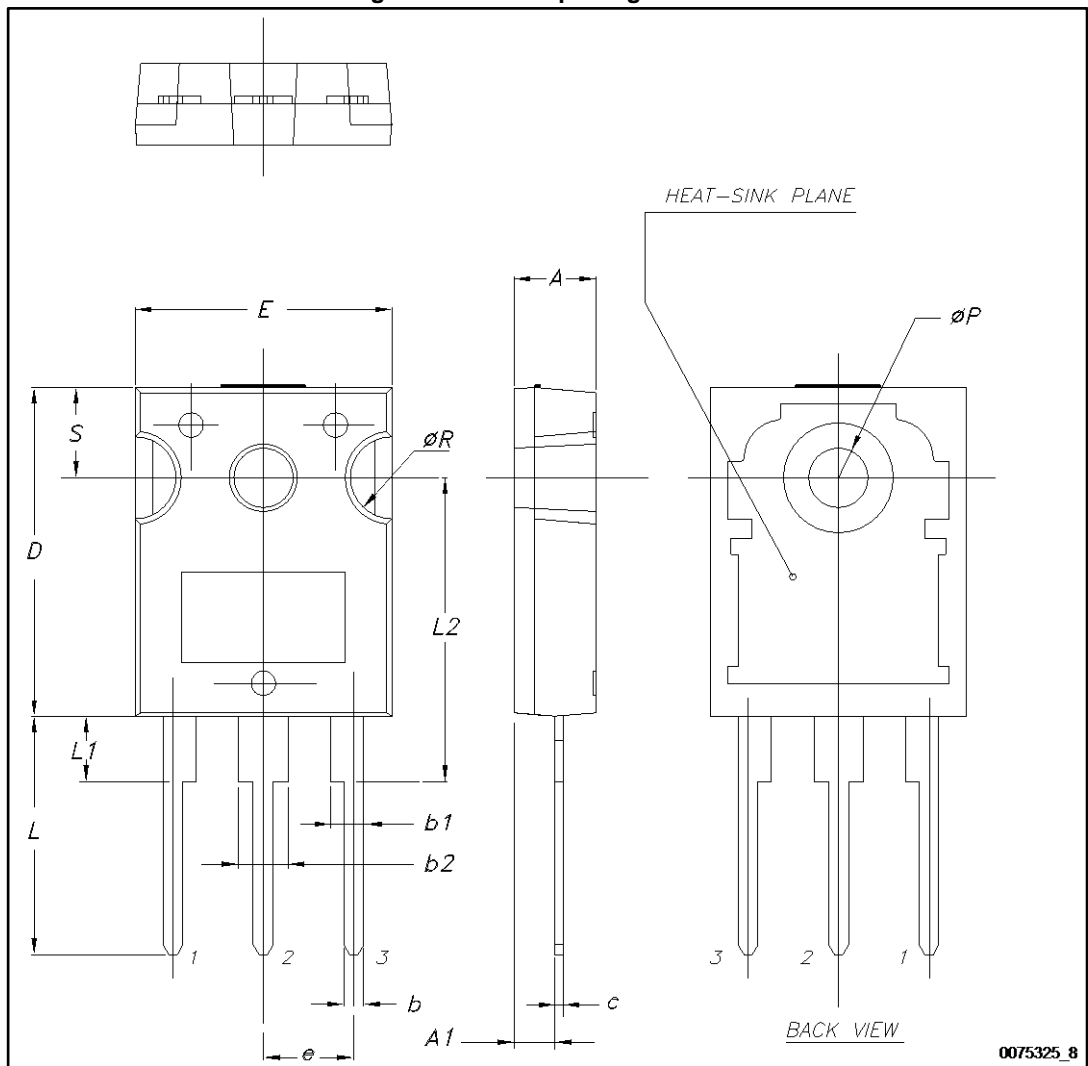

Table 6: TO-247 package mechanical data

Ref.	Dimensions					
	Millimeters			Inches		
	Min.	Typ.	Max.	Min.	Typ.	Max.
A	4.85		5.15	0.191		0.203
A1	2.20		2.60	0.086		0.102
b	1.00		1.40	0.039		0.055
b1	2.00		2.40	0.078		0.094
b2	3.00		3.40	0.118		0.133
c	0.40		0.80	0.015		0.031
D ⁽¹⁾	19.85		20.15	0.781		0.793
E	15.45		15.75	0.608		0.620
e	5.30	5.45	5.60	0.209	0.215	0.220
L	14.20		14.80	0.559		0.582
L1	3.70		4.30	0.145		0.169
L2		18.50			0.728	
ØP ⁽²⁾	3.55		3.65	0.139		0.143
ØR	4.50		5.50	0.177		0.217
S	5.30	5.50	5.70	0.209	0.216	0.224

Notes:

⁽¹⁾Dimension D plus gate protusion does not exceed 20.5 mm

⁽²⁾Resin thickness around the mounting hole is not less than 0.9 mm.

3 Ordering information

Table 7: Ordering information

Order code	Marking	Package	Weight	Base qty.	Delivery mode
STTH6003CW	STTH6003CW	TO-247	4.36 g	30	Tube

4 Revision history

Table 8: Document revision history

Date	Revision	Changes
Oct-1999	5C	Previous revision.
18-Jun-2014	6	Removed ISOTOP package. Updated <i>Section 2: Package information</i> .
21-Nov-2016	7	Updated Table 7: "Ordering information" . Minor text changes.

IMPORTANT NOTICE – PLEASE READ CAREFULLY

STMicroelectronics NV and its subsidiaries ("ST") reserve the right to make changes, corrections, enhancements, modifications, and improvements to ST products and/or to this document at any time without notice. Purchasers should obtain the latest relevant information on ST products before placing orders. ST products are sold pursuant to ST's terms and conditions of sale in place at the time of order acknowledgement.

Purchasers are solely responsible for the choice, selection, and use of ST products and ST assumes no liability for application assistance or the design of Purchasers' products.

No license, express or implied, to any intellectual property right is granted by ST herein.

Resale of ST products with provisions different from the information set forth herein shall void any warranty granted by ST for such product.

ST and the ST logo are trademarks of ST. All other product or service names are the property of their respective owners.

Information in this document supersedes and replaces information previously supplied in any prior versions of this document.

© 2016 STMicroelectronics – All rights reserved