

# 2.4 GHz External WiFi Antenna



AEACAC025009-S2400

25.9 x Ø9.5mm



RoHS/RoHS II Compliant

MSL = N/A: NOT APPLICABLE

## FEATURES

- Operates in 2400 MHz
- Gain of 2dBi
- Input power 10W
- VSWR  $\leq$  2.5

## APPLICATIONS

- Wifi
- ISM Applications
- Portable Devices
- Set-Top Boxes
- Network Devices

## ELECTRICAL SPECIFICATIONS

Item	min	Typ.	Max.	Units	Note
Frequency Range		2400~2483.5		MHz	
Bandwidth		83.5			
VSWR			2.5		
Polarization Model		Linear			
Impedance		50		$\Omega$	
Gain		2		dBi	
Operating Temperature	-40		+85	$^{\circ}\text{C}$	
Input Power			10	W	

## RETURN - LOSS CHARACTERISTICS

### S11 Return-Loss

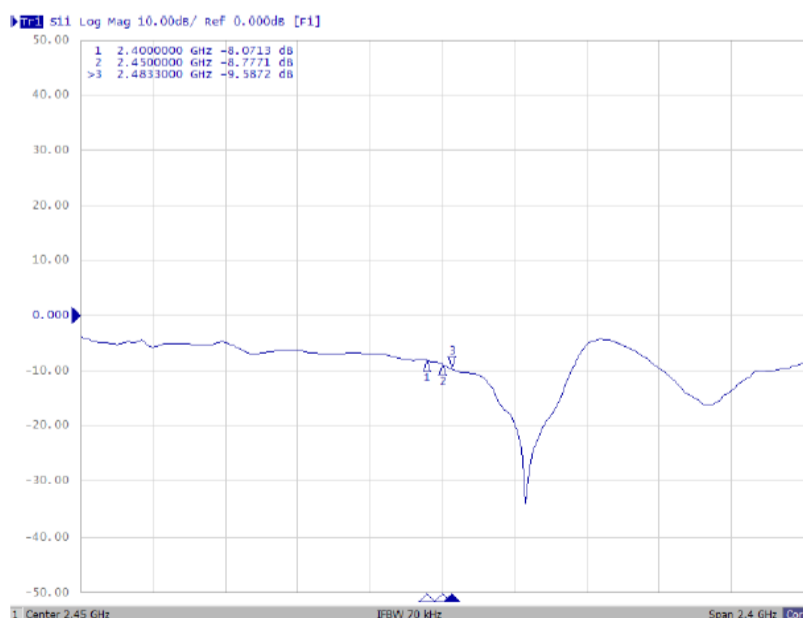

# 2.4 GHz External WiFi Antenna



AEACAC025009-S2400



25.9 x Ø9.5mm  
RoHS/RoHS II Compliant

MSL = N/A: NOT APPLICABLE

## RADIATION PATTERNS

Antenna 2D Patterns  
XY Plane

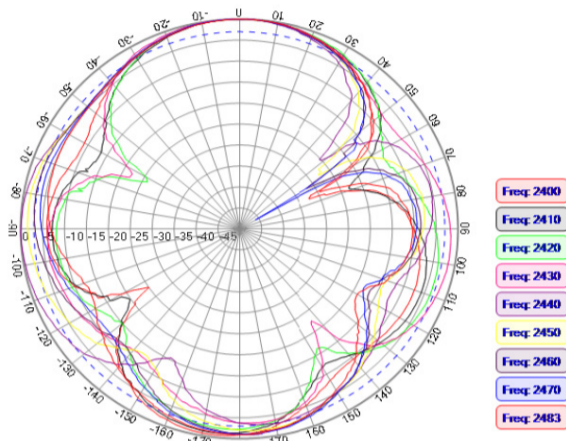

XZ Plane

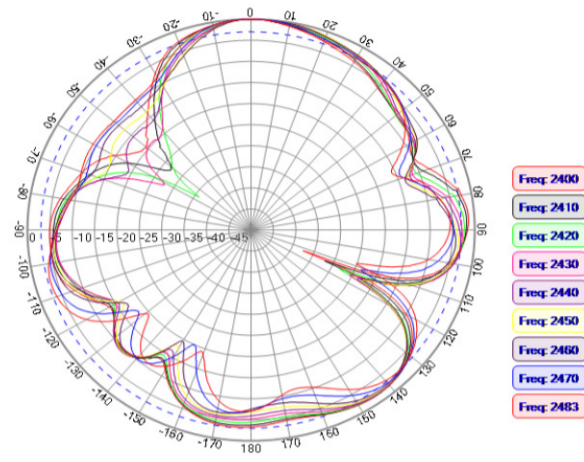

YZ Plane

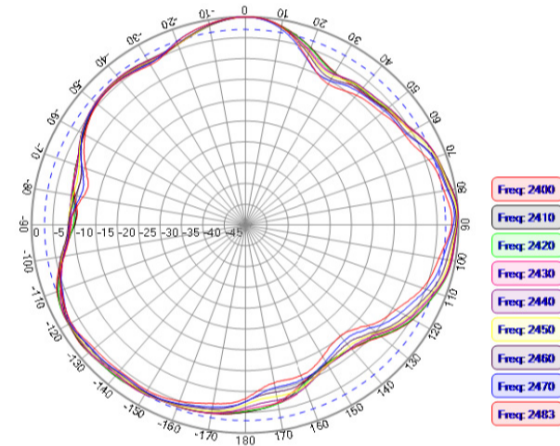

Antenna 3D Patterns  
2400 MHz

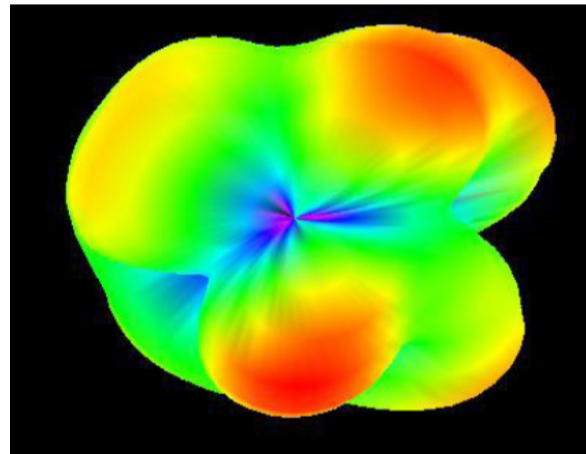

2450 MHz

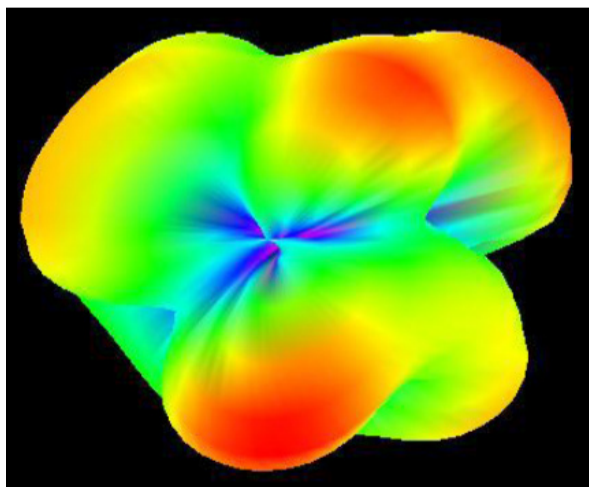

2483 MHz

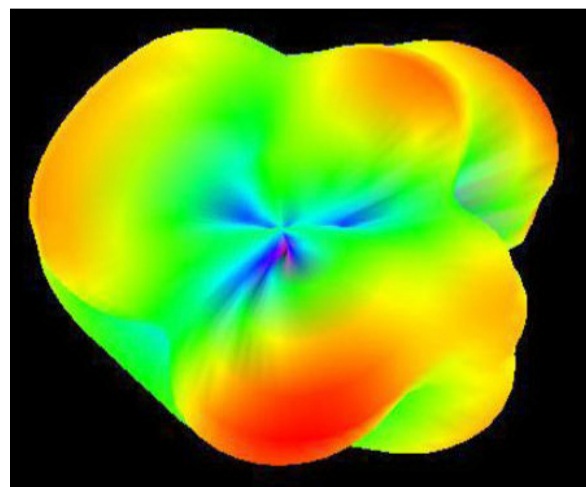

Frequency (MHz)	2400	2450	2483
Peak Gain (dBi)	1.83	1.7	1.4
Efficiency (%)	62	63	65

# 2.4 GHz External WiFi Antenna



AEACAC025009-S2400

**25.9 x Ø9.5mm**  
**RoHS/RoHS II Compliant**  
**MSL = N/A: NOT APPLICABLE**

## DIMENSIONS

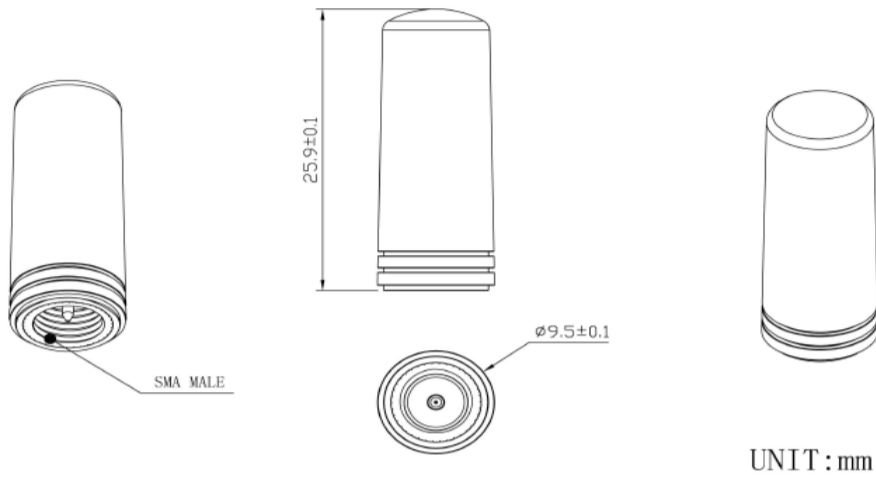

Parameters	Description
RF Connector	SMA Male
Mounting Type	Connector mount

## PACKAGING:

Each 370 x 360 x 165 mm size carton includes 1000 pcs antenna, 5kgs/carton.

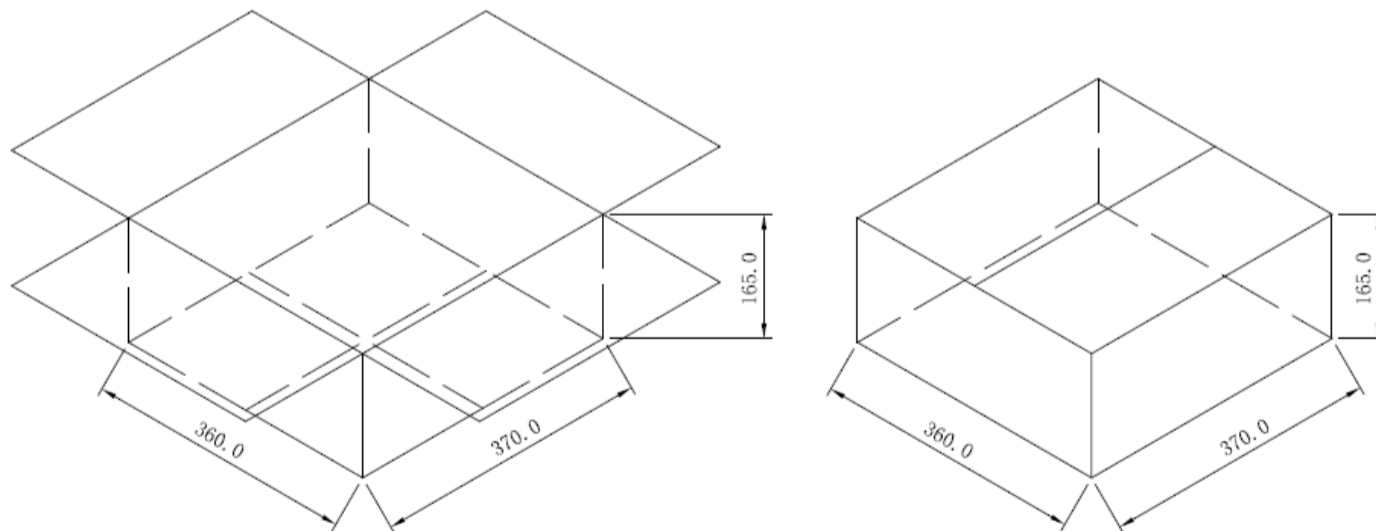

Unit: mm