

Description

AH266 is an integrated Hall sensor with output drivers designed for electronic commutation of brush-less DC motor applications. The device includes an on-chip Hall voltage generator for magnetic sensing, a comparator that amplifies the Hall voltage, a Schmitt trigger to provide switching hysteresis for noise rejection, and complementary Darlington open-collector drivers for sinking large current loads. An internal band-gap regulator is used to provide temperature compensated supply voltage for internal circuits and allows a wide operating supply range.

If a magnetic flux density (B) is larger than operation point (Bop), DO will turn on (low) and DOB will turn off (high). The output state is latched prior to reaching release point (Brp). If $B < Brp$, DO will turn off and DOB will turn on. AH266 is rated for operation over temperature range from -20°C to $+85^{\circ}\text{C}$ and voltage range from 4V to 28V. The devices are available in low cost die forms or rugged 4 pin SIP packages.

Pin Assignments

(Top View)

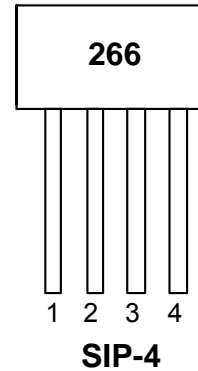

Features

- On-Chip Hall Plate
- Operating Voltage: 4V to 28V
- Output Current: 400mA (Continuous, $+25^{\circ}\text{C}$)
- Reverse Protection Diode Only for Chip Reverse Power Connecting (Note 1)
- Output Protection Zener Breakdown $V_Z = 62\text{V}$ (Typ.)
- Lead Free package: SIP-4
- SIP-4: Available in "Green" Molding Compound (No Br, Sb)
- RoHS Compliant (Note 2)
- **Lead-Free Finish; RoHS Compliant (Notes 1 & 2)**
- **Halogen and Antimony Free. "Green" Device (Note 3)**

Applications

- Dual-Coil Brushless DC Motor
- Dual-Coil Brushless DC Fan
- Revolution Counting
- Speed Measurement

- Notes:
1. EU Directive 2002/95/EC (RoHS) & 2011/65/EU (RoHS 2) compliant. All applicable RoHS exemptions applied.
 2. See http://www.diodes.com/quality/lead_free.html for more information about Diodes Incorporated's definitions of Halogen- and Antimony-free, "Green" and Lead-free.
 3. Halogen- and Antimony-free "Green" products are defined as those which contain $<900\text{ppm}$ bromine, $<900\text{ppm}$ chlorine ($<1500\text{ppm}$ total Br + Cl) and $<1000\text{ppm}$ antimony compounds.

Typical Applications Circuit

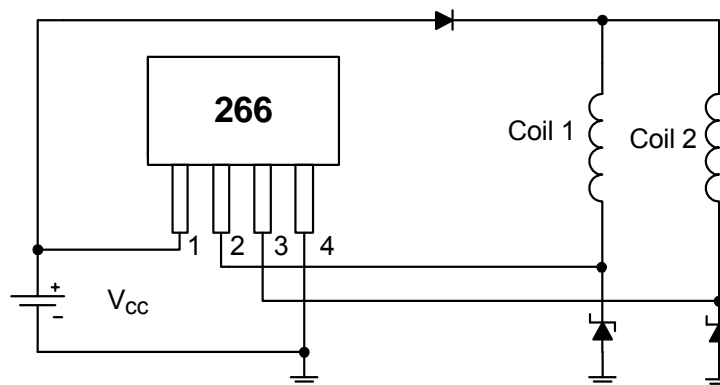

Brush-Less DC Fan

Pin Descriptions

Pin Name	P/I/O	Pin #	Description
V _{CC}	P	1	Power Supply Input
DO	O	2	Output Pin
DOB	O	3	Output Pin
GND	P	4	Ground

Functional Block Diagram

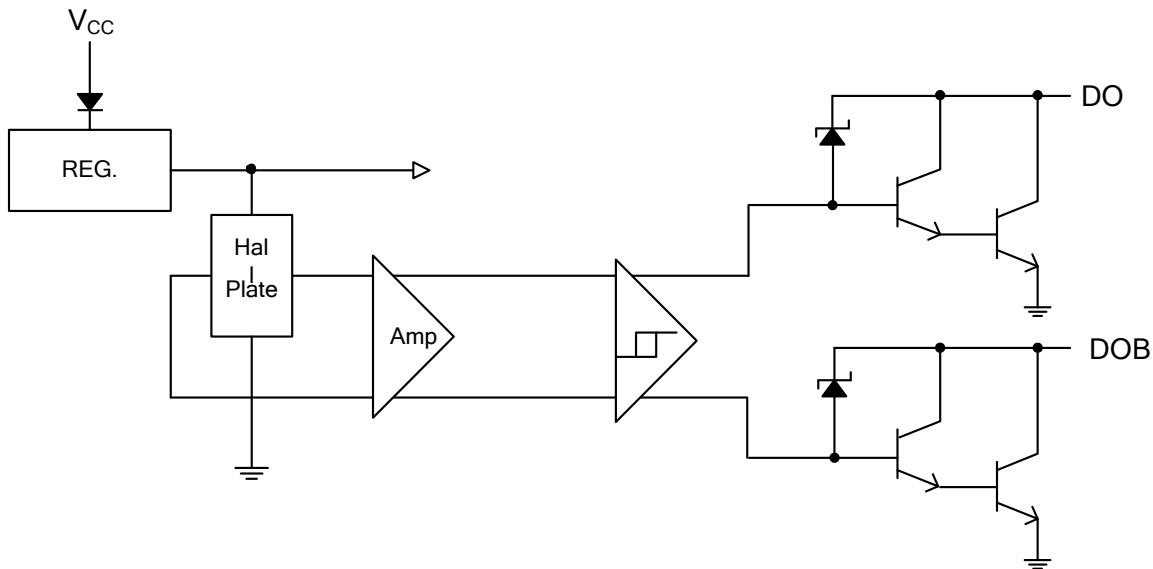

Absolute Maximum Ratings (@T_A = +25°C, unless otherwise specified.)

Symbol	Parameter	Rating	Unit
V _{CC}	Supply Voltage	28	V
V _{out (off)}	Output "OFF" Voltage	28	V
I _{O (con)}	Output "ON" Current	400 (Note 5)	mA
I _{O (hold)}		500	mA
I _{O (peak)}		700	mA
B	Magnetic Flux Density	Unlimited	Gauss
T _{ST}	Storage Temperature Range	-65 to +150	°C
P _D	Power Dissipation (Note 6)	550	mW
θ _{JA}	Thermal Resistance Junction-to-Ambient (SIP-4)	227	°C/W
θ _{JC}	Thermal Resistance Junction-to-Case (SIP-4)	49	°C/W

Magnetic Characteristics

A grade

(1mT = 10 Gauss)

Symbol	Characteristic	Min	Typ.	Max	Unit
Bop	Operation Point	10	—	70	Gauss
Brp	Release Point	-70	—	-10	Gauss
Bhy	Hysteresis	—	80	—	Gauss

B grade

Symbol	Characteristic	Min	Typ.	Max	Unit
Bop	Operation Point	—	—	100	Gauss
Brp	Release Point	-100	—	—	Gauss
Bhy	Hysteresis	—	80	—	Gauss

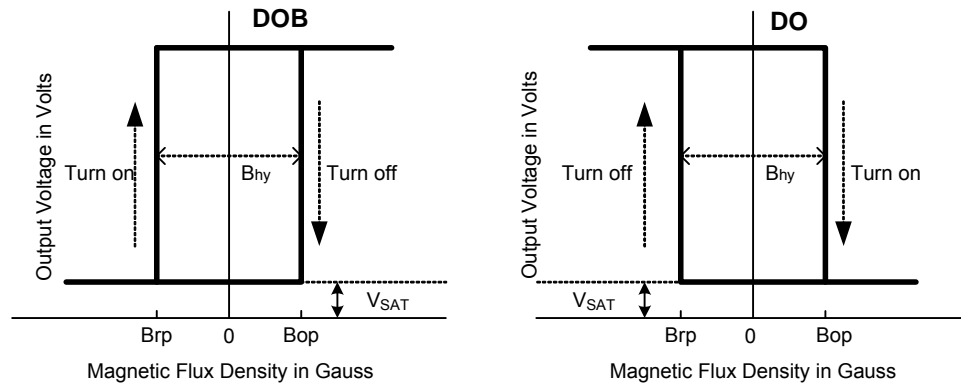

Operation Characteristics

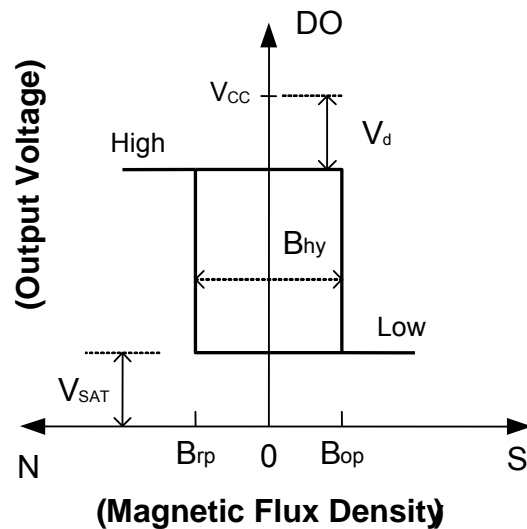
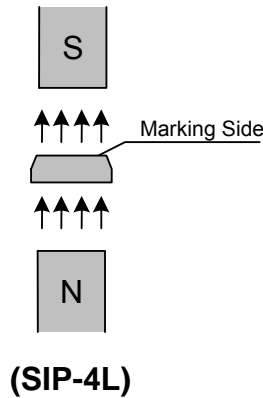

Performance Characteristics

T _A (°C)	25	50	60	70	80	85	90	95	100
P _D (mW)	550	440	396	352	308	286	264	242	220
T _A (°C)	105	110	115	120	125	130	135	140	150
P _D (mW)	198	176	154	132	110	88	66	44	0

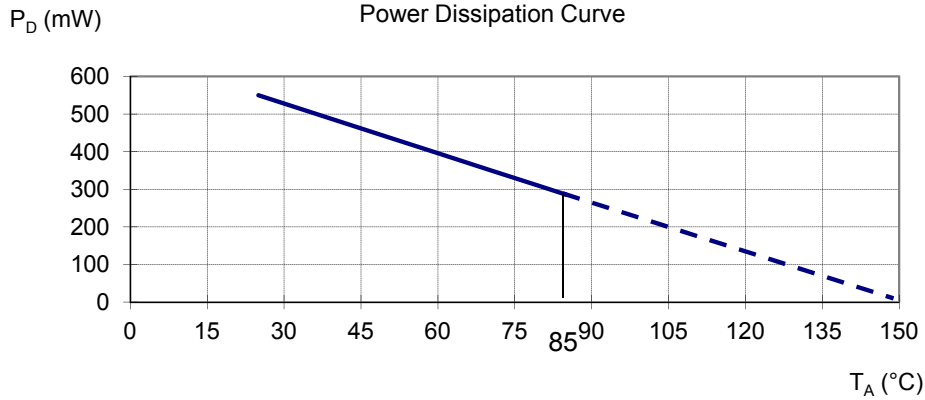

Ordering Information

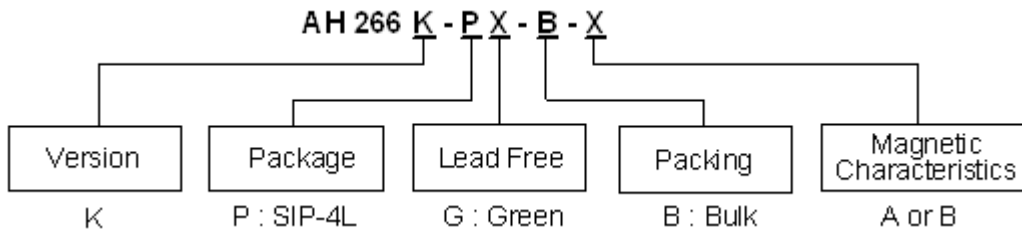

Device	Package Code	Packaging (Note 8)	Bulk		Magnetic Characteristics
			Quantity	Part Number Suffix	
AH266K-PG-B-A	P	SIP-4	1000	-B	A
AH266K-PG-B-B	P	SIP-4	1000	-B	B

Note: 8. For packaging details, go to our website at <http://www.diodes.com/products/packages.html>

Marking Information

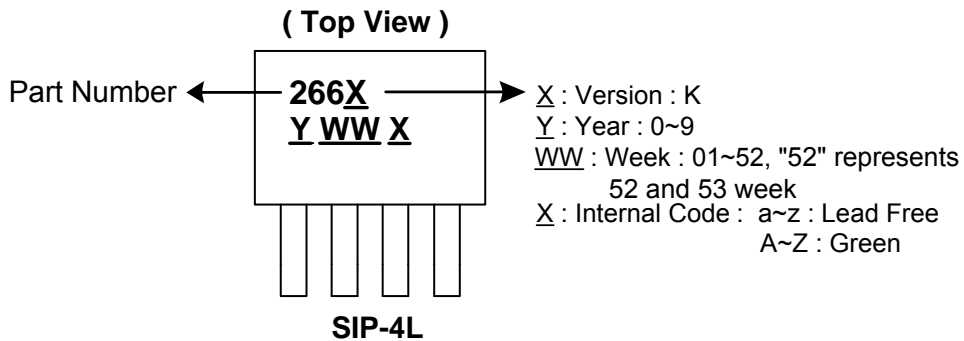

Package Outline Dimensions (All dimensions in mm.)

(1) Package type: SIP-4L

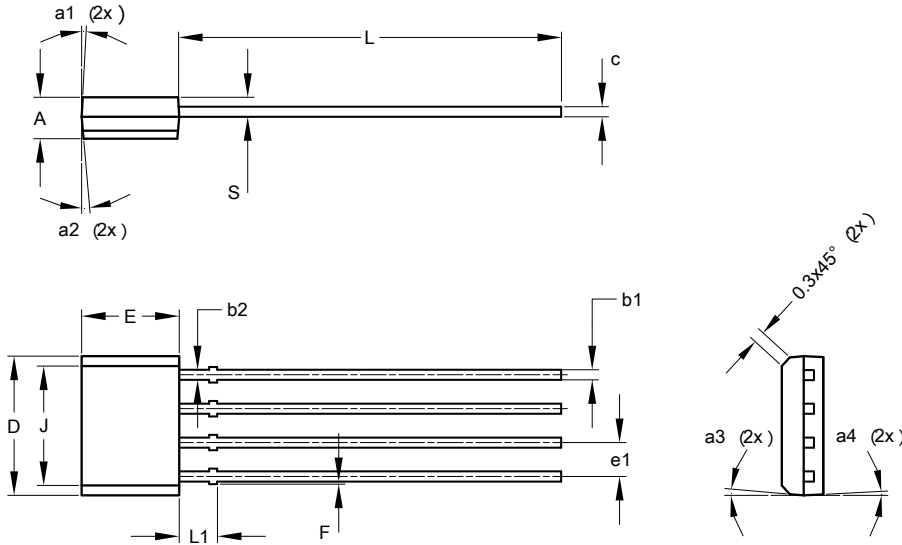

SIP-4			
Dim	Min	Max	Typ
A	1.45	1.65	1.55
b1	0.38	0.44	0.40
b2	-	-	0.48
c	0.35	0.45	0.40
D	5.12	5.32	5.22
e1	1.24	1.30	1.27
E	3.55	3.75	3.65
F	0.00	0.20	-
J	4.10	4.30	4.20
L	14.00	14.60	14.30
L1	1.32	1.52	1.42
S	0.63	0.83	0.73
a1	-	5°	3°
a2	4°	7°	5°
a3	4°	7°	5°
a4	-	5°	3°

All Dimensions in mm

Min/Max (in mm)

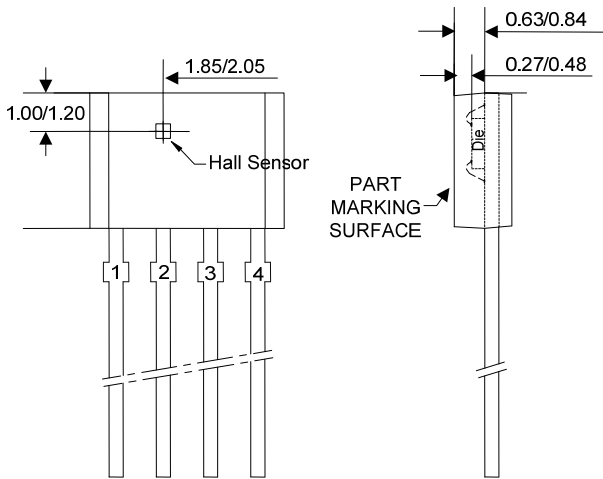

IMPORTANT NOTICE

DIODES INCORPORATED MAKES NO WARRANTY OF ANY KIND, EXPRESS OR IMPLIED, WITH REGARDS TO THIS DOCUMENT, INCLUDING, BUT NOT LIMITED TO, THE IMPLIED WARRANTIES OF MERCHANTABILITY AND FITNESS FOR A PARTICULAR PURPOSE (AND THEIR EQUIVALENTS UNDER THE LAWS OF ANY JURISDICTION).

Diodes Incorporated and its subsidiaries reserve the right to make modifications, enhancements, improvements, corrections or other changes without further notice to this document and any product described herein. Diodes Incorporated does not assume any liability arising out of the application or use of this document or any product described herein; neither does Diodes Incorporated convey any license under its patent or trademark rights, nor the rights of others. Any Customer or user of this document or products described herein in such applications shall assume all risks of such use and will agree to hold Diodes Incorporated and all the companies whose products are represented on Diodes Incorporated website, harmless against all damages.

Diodes Incorporated does not warrant or accept any liability whatsoever in respect of any products purchased through unauthorized sales channel. Should Customers purchase or use Diodes Incorporated products for any unintended or unauthorized application, Customers shall indemnify and hold Diodes Incorporated and its representatives harmless against all claims, damages, expenses, and attorney fees arising out of, directly or indirectly, any claim of personal injury or death associated with such unintended or unauthorized application.

Products described herein may be covered by one or more United States, international or foreign patents pending. Product names and markings noted herein may also be covered by one or more United States, international or foreign trademarks.

This document is written in English but may be translated into multiple languages for reference. Only the English version of this document is the final and determinative format released by Diodes Incorporated.

LIFE SUPPORT

Diodes Incorporated products are specifically not authorized for use as critical components in life support devices or systems without the express written approval of the Chief Executive Officer of Diodes Incorporated. As used herein:

A. Life support devices or systems are devices or systems which:

1. are intended to implant into the body, or
2. support or sustain life and whose failure to perform when properly used in accordance with instructions for use provided in the labeling can be reasonably expected to result in significant injury to the user.

B. A critical component is any component in a life support device or system whose failure to perform can be reasonably expected to cause the failure of the life support device or to affect its safety or effectiveness.

Customers represent that they have all necessary expertise in the safety and regulatory ramifications of their life support devices or systems, and acknowledge and agree that they are solely responsible for all legal, regulatory and safety-related requirements concerning their products and any use of Diodes Incorporated products in such safety-critical, life support devices or systems, notwithstanding any devices- or systems-related information or support that may be provided by Diodes Incorporated. Further, Customers must fully indemnify Diodes Incorporated and its representatives against any damages arising out of the use of Diodes Incorporated products in such safety-critical, life support devices or systems.

Copyright © 2013, Diodes Incorporated

www.diodes.com