

# G3VM-81HR/101HR

MOS FET Relays SOP 6-pin, High-current and Low-ON-resistance Type

## MOS FET Relays in SOP 6-pin packages that achieve the low ON resistance and high switching capacitance of a mechanical relay

- Load voltage: 80 V/100 V
- 80-V Relay: Continuous load current of 1.25 A (2.5 A) max. \*
- 100-V Relay: Continuous load current of 3 A (6 A) max. \*

\* Values in parentheses are for connection C.



Note: The actual product is marked differently from the image shown here.

RoHS Compliant

### Application Examples

- Semiconductor test equipment
- Security equipment
- Amusement equipment
- Communication equipment
- Industrial equipment
- Test & Measurement equipment
- Power circuit

### Package

(Unit : mm, Average)

SOP 6-pin

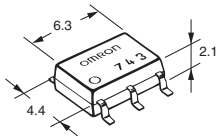

Note: The actual product is marked differently from the image shown here.

### Model Number Legend

G3VM-□□□□□  
1 2 3 4 5

- 1. Load Voltage**  
8 : 80 V  
10 : 100 V
- 2. Contact form**  
1 : 1a (SPST-NO)
- 3. Package**  
H : SOP 6-pin
- 4. Additional functions**  
R: Low ON resistance
- 5. Other informations**  
When specifications overlap, serial code is added in the recorded order.

### Ordering Information

Package	Contact form	Terminals	Load voltage (peak value) *	Continuous load current (peak value) *		Stick packaging		Tape packaging	
				Connection A, B	Connection C	Model	Minimum package quantity	Model	Minimum package quantity
SOP6	1a (SPST-NO)	Surface-mounting Terminals	80 V	1.25 A	2.5 A	G3VM-81HR	75	G3VM-81HR(TR)	2,500
			100 V	1.4 A	2.8 A	G3VM-101HR		G3VM-101HR(TR)	
			100 V	2 A	4 A	G3VM-101HR1		G3VM-101HR1(TR05)	500
			100 V	3 A	6 A	G3VM-101HR2		G3VM-101HR2(TR05)	

\* The AC peak and DC value are given for the load voltage and continuous load current.

Note: To order tape packaging for Relays with surface-mounting terminals, add "(TR)", "(TR05)" to the end of the model number.

SOP 6-pin / 81HR / 101HR

### ■ Absolute Maximum Ratings (Ta = 25°C)

Item		Symbol	G3VM-81HR	G3VM-101HR	G3VM-101HR1	G3VM-101HR2	Unit	Measurement conditions	
Input	LED forward current	$I_F$	50	30			mA		
	LED forward current reduction rate	$\Delta I_F / ^\circ C$	-0.5	-0.3			mA/ $^\circ C$	Ta $\geq 25^\circ C$	
	LED reverse voltage	$V_R$	5			6	V		
	Connection temperature	$T_J$	125				$^\circ C$		
Output	Load voltage (AC peak/DC)	$V_{OFF}$	80	100			V		
	Continuous load current	Connection A	$I_o$	1.25	1.4	2	3	A	Connection A: AC peak/DC Connection B and C: DC
		Connection B		2.5	2.8	4	6		
		Connection C							
	ON current reduction rate	Connection A	$\Delta I_o / ^\circ C$	-12.5	-18.7	-20	-30	mA/ $^\circ C$	G3VM-101HR : Ta $\geq 50^\circ C$ Others : Ta $\geq 25^\circ C$
		Connection B		-25.0	-37.3	-40	-60		
		Connection C							
Pulse ON current	$I_{op}$	3.75	4	6	9	A	t=100 ms, Duty=1/10		
Connection temperature	$T_J$	125				$^\circ C$			
Dielectric strength between I/O *	$V_{i-o}$	1,500				Vrms	AC for 1 min		
Ambient operating temperature	$T_a$	-20 to +85	-40 to +85		-40 to +110		$^\circ C$	With no icing or condensation	
Ambient storage temperature	$T_{stg}$	-40 to +125	-55 to +125			$^\circ C$			
Soldering temperature	-	260				$^\circ C$	10 s		

\* The dielectric strength between the input and output was checked by applying voltage between all pins as a group on the LED side and all pins as a group on the light-receiving side.

#### Connection Diagram

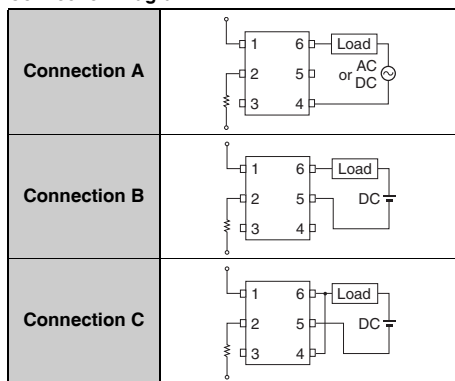

## Electrical Characteristics (Ta = 25°C)

Item		Symbol	G3VM-81HR	G3VM-101HR	G3VM-101HR1	G3VM-101HR2	Unit	Measurement conditions		
Input	LED forward voltage	VF	Minimum	1.0	1.18	1.5	V	IF=10 mA		
			Typical	1.15	1.33	1.65				
			Maximum	1.3	1.48	1.8				
	Reverse current	IR	Maximum	10				μA	VR=5 V	
	Capacitance between terminals	CT	Typical	15	70			pF	V=0, f=1 MHz	
Trigger LED forward current	IFT	Typical	2	0.4		0.35	mA	G3VM-81HR : Io=1250 mA Others : Io=100 mA		
		Maximum	5	3						
		Release LED forward current	IFC	Minimum	0.2	0.1				mA
Output	Maximum resistance with output ON	RON	Typical	Connection A	0.11	0.1	0.045	0.05	Ω	G3VM-81HR : IF=5 mA, Io= Continuous load current ratings Others : IF=5 mA, Io= Continuous load current ratings, t < 1 s
				Connection B	0.06	0.05	0.022	0.025		
				Connection C	0.03	0.025	0.011	0.013		
				Connection A	0.15	0.2	0.07	0.065		
				Connection B	0.08	0.1	0.035	0.033		
				Connection C	0.04	-	0.018	0.016		
Current leakage when the relay is open	ILEAK	Typical	1.2	-	-	-	nA	G3VM-81HR : Voff=20 V, Ta=50°C Others : Voff= Load voltage ratings		
		Maximum	1.5	10	1,000					
Capacitance between terminals	COFF	Typical	460	1,000	500	460	pF	G3VM-81HR : V=0, f=100 MHz Others : V=0, f=1 MHz		
		Maximum	1,000	-	-	-				
Capacitance between I/O terminals	CI-O	Typical	0.8					pF	f=1 MHz, Vs=0 V	
Insulation resistance between I/O terminals	RI-O	Minimum	1,000					MΩ	VI-o=500 VDC, RoH≤60%	
		Typical	10 <sup>8</sup>							
Turn-ON time	TON	Typical	2.0	1.0	1.1	0.45	ms	IF=5 mA, RL=200 Ω, VDD=20 V *		
		Maximum	3.0	5.0		2				
Turn-OFF time	TOFF	Typical	0.7	0.15	0.1		ms	IF=5 mA, RL=200 Ω, VDD=20 V *		
		Maximum	1.0			0.5				

\* Turn-ON and Turn-OFF Times

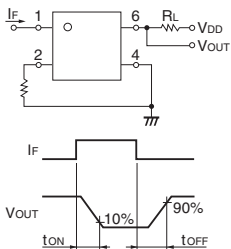

## Recommended Operating Conditions

For usage with high reliability, Recommended Operation Conditions is a measure that takes into account the derating of Absolute Maximum Ratings and Electrical Characteristics.

Each item on this list is an independent condition, so it is not simultaneously satisfy several conditions.

Item	Symbol		G3VM-81HR	G3VM-101HR	G3VM-101HR1	G3VM-101HR2	Unit
Load voltage (AC peak/DC)	VDD	Maximum	64	100	80		V
Operating LED forward current	IF	Minimum	5				mA
		Typical	-	7.5	10		
		Maximum	30	20	25		
Continuous load current (AC peak/DC)	Io	Maximum	1.25	1.1	2	3	A
Ambient operating temperature	Ta	Minimum	25	-20			°C
		Maximum	60	65		85	

## Spacing and Insulation

Item	Minimum	Unit
Creepage distances	4.0	mm
Clearance distances	4.0	
Internal isolation thickness	0.1	

## Engineering Data

### LED forward current vs. Ambient temperature G3VM-81HR/101HR/101HR1

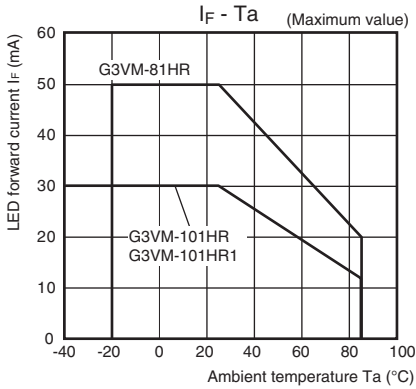

### G3VM-101HR2

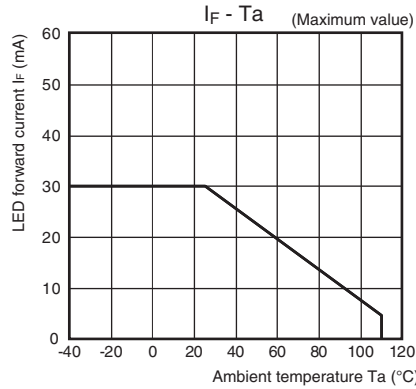

### Continuous load current vs. Ambient temperature G3VM-101HR/101HR1

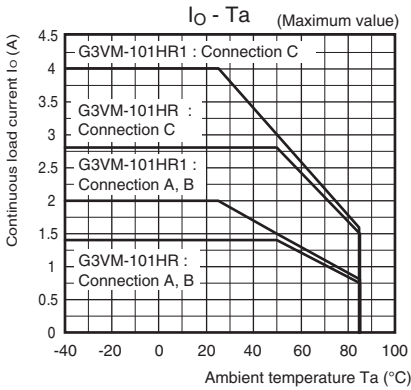

### G3VM-81HR

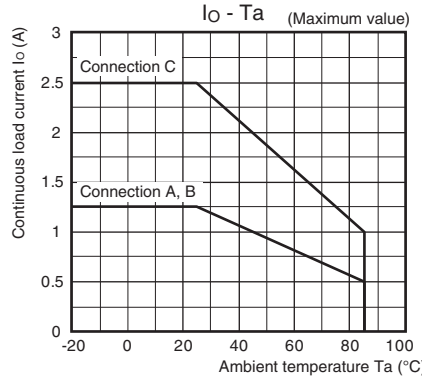

### G3VM-101HR2

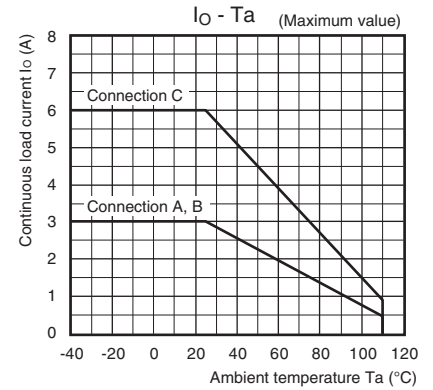

### LED forward current vs. LED forward voltage G3VM-81HR/101HR/101HR1

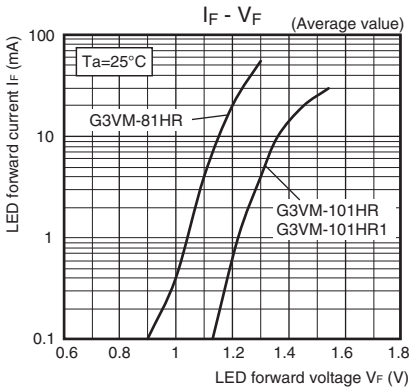

### G3VM-101HR2

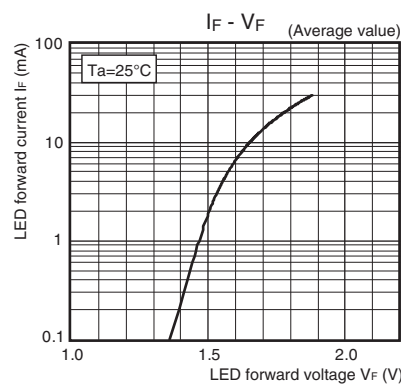

### Continuous load current vs. On-state voltage G3VM-81HR/101HR/101HR1

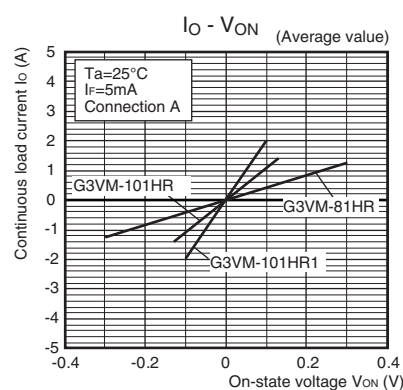

### G3VM-101HR2

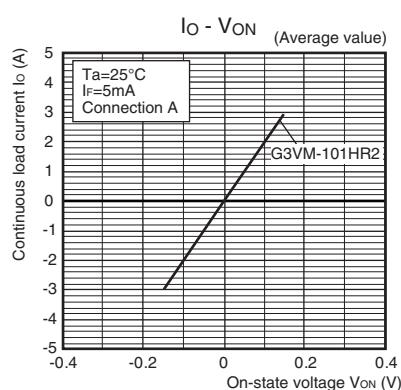

### On-state resistance vs. Ambient temperature

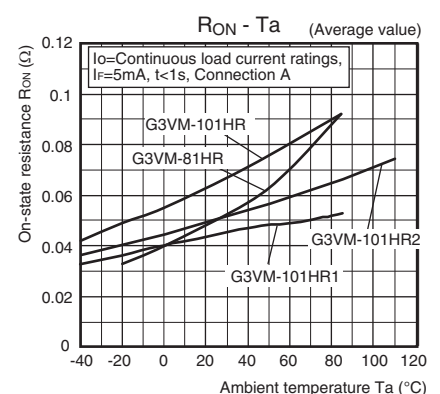

## Engineering Data

### Trigger LED forward current vs. Ambient temperature G3VM-101HR/101HR1/101HR2

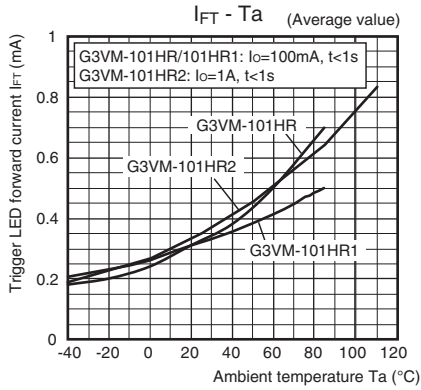

### G3VM-81HR

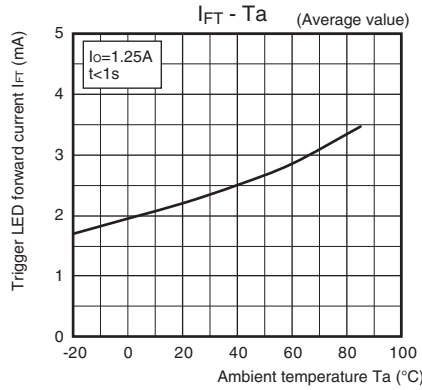

### Turn ON, Turn OFF time vs. LED forward current G3VM-81HR/101HR/101HR1

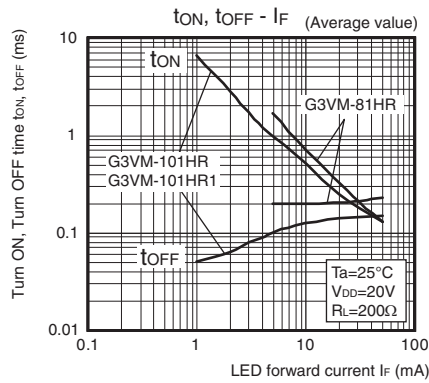

### G3VM-101HR2

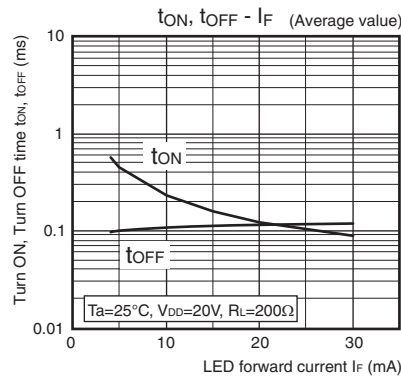

### Turn ON, Turn OFF time vs. Ambient temperature G3VM-81HR/101HR/101HR1

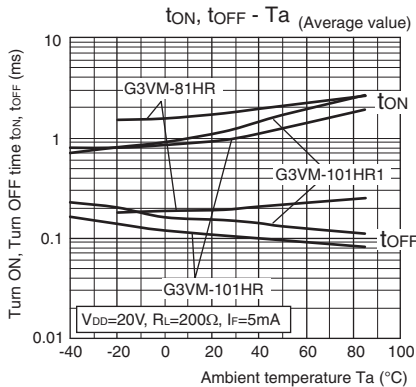

### G3VM-101HR2

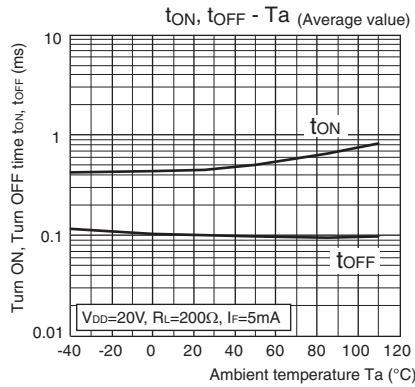

### Current leakage vs. Load voltage G3VM-101HR

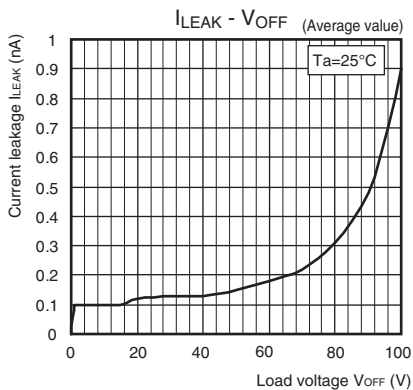

### G3VM-101HR2

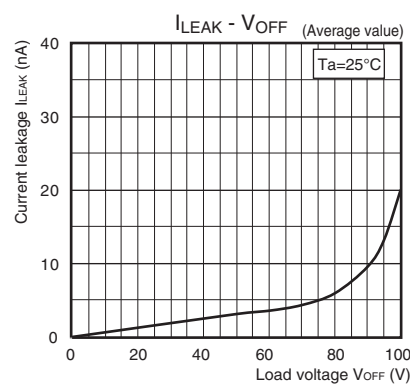

### ● Current leakage vs. Ambient temperature G3VM-81HR/101HR1

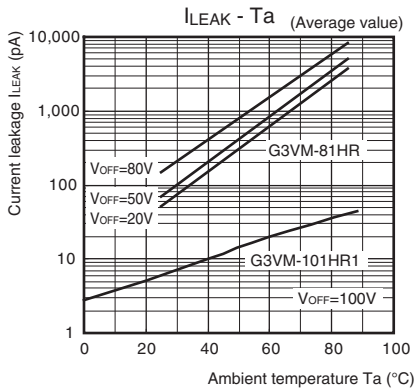

### G3VM-101HR2

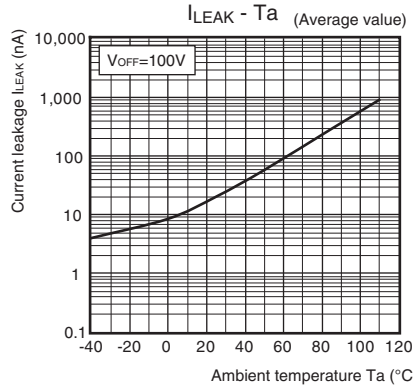

### ● Output terminal capacitance vs. Load voltage G3VM-101HR/101HR2

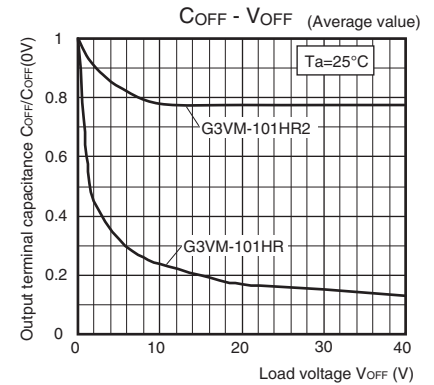

## ■ Appearance / Terminal Arrangement / Internal Connections

### ● Appearance

#### SOP (Small Outline Package)

SOP 6-pin

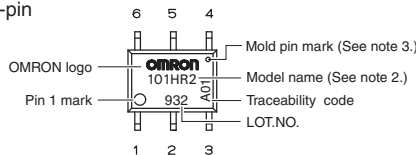

- Note: 1.** The actual product is marked differently from the image shown here.
- Note: 2.** "G3VM" does not appear in the model number on the Relay.
- Note: 3.** The indentation in the corner diagonally opposite from the pin 1 mark is from a pin on the mold.

### ● Terminal Arrangement/Internal Connections (Top View)

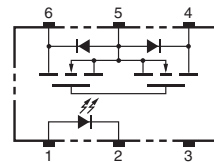

### ■ Dimensions (Unit: mm)

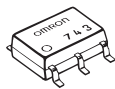

#### Surface-mounting Terminals

Weight: 0.13 g

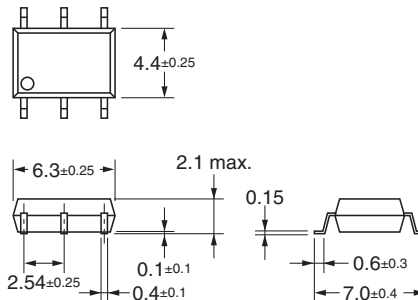

#### Actual Mounting Pad Dimensions

(Recommended Value, Top View)

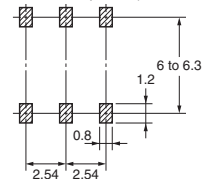

**Note:** The actual product is marked differently from the image shown here.

## ■ Approved Standards

UL recognized

Approved Standards	Contact form	File No.
UL (recognized)	1a (SPST-NO)	E80555

**Note:** Applying G3VM-101HR2 for UL recognition

## ■ Safety Precautions

- Refer to the *Common Precautions for All MOS FET Relays* for precautions that apply to all MOS FET Relays.

Please check each region's Terms & Conditions by region website.

## OMRON Corporation

Electronic and Mechanical Components Company

### Regional Contact

**Americas**

<https://www.components.omron.com/>

**Asia-Pacific**

<https://ecb.omron.com.sg/>

**Korea**

<https://www.omron-ecb.co.kr/>

**Europe**

<http://components.omron.eu/>

**China**

<https://www.ecb.omron.com.cn/>

**Japan**

<https://www.omron.co.jp/ecb/>