

LH5116NA-10F

16K SRAM

(Model Number: LH5116NC)

Spec. Issue Date: Oct. 22, 2004
Spec No: EL16X148

SPEC No.	EL16X148
ISSUE:	Oct. 22. 2004

To: _____

S P E C I F I C A T I O N S

Product Type _____ 16k SRAM _____

LH5116NA-10F

Model No. _____ (LH5116NC) _____

*This specifications contains 20 pages including the cover and appendix.
If you have any objections, please contact us before issuing purchasing order.

CUSTOMER ACCEPTANCE

DATE: _____

BY: _____

PRESENTED

BY: M. Okada

M. OKADA
Dept. General Manager

REVIEWED BY: PREPARED BY:

M. Kawat J. Morimura

Product Development Dept. 3
System Flash Memory Division
Integrated Circuits Group
SHARP CORPORATION

- Handle this document carefully for it contains material protected by international copyright law. Any reproduction, full or in part, of this material is prohibited without the express written permission of the company.
- When using the products covered herein, please observe the conditions written herein and the precautions outlined in the following paragraphs. In no event shall the company be liable for any damages resulting from failure to strictly adhere to these conditions and precautions.
 - (1) The products covered herein are designed and manufactured for the following application areas. When using the products covered herein for the equipment listed in Paragraph (2), even for the following application areas, be sure to observe the precautions given in Paragraph (2). Never use the products for the equipment listed in Paragraph (3).
 - Office electronics
 - Instrumentation and measuring equipment
 - Machine tools
 - Audiovisual equipment
 - Home appliances
 - Communication equipment other than for trunk lines
 - (2) Those contemplating using the products covered herein for the following equipment which demands high reliability, should first contact a sales representative of the company and then accept responsibility for incorporating into the design fail-safe operation, redundancy, and other appropriate measures for ensuring reliability and safety of the equipment and the overall system.
 - Control and safety devices for airplanes, trains, automobiles, and other transportation equipment
 - Mainframe computers
 - Traffic control systems
 - Gas leak detectors and automatic cutoff devices
 - Rescue and security equipment
 - Other safety devices and safety equipment, etc.
 - (3) Do not use the products covered herein for the following equipment which demands extremely high performance in terms of functionality, reliability, or accuracy.
 - Aerospace equipment
 - Communications equipment for trunk lines
 - Control equipment for the nuclear power industry
 - Medical equipment related to life support, etc.
 - (4) Please direct all queries and comments regarding the interpretation of the above three Paragraphs to a sales representative of the company.
- Please direct all queries regarding the products covered herein to a sales representative of the company.

Contents

1. Description	2
2. Pin Configuration	2
3. Truth Table	3
4. Block Diagram	3
5. Absolute Maximum Ratings	4
6. Recommended DC Operating Conditions	4
7. DC Electrical Characteristics	4
8. AC Electrical Characteristics	5
9. Data Retention Characteristics	6
10. Pin Capacitance	6
11. Timing Chart	7
12. Package and Packing Specification	10

1. Description

The LH5116NA-10F is a static RAM organized as 2,048 × 8 bit with provides low-power standby mode.

It is fabricated using silicon-gate CMOS process technology.

Features

- Access Time 100 ns (Max.)
- Operating current 40 mA (Max.)
- Standby current 1.0 μA (Max.)
- Data retention current 0.2 μA (Max. V_{CCDR} = 2V, T_a = 25°C)
- Wide operating voltage range 4.5 V to 5.5 V
- Operating temperature 0°C to +70°C
- Fully static operation
- Three-state output
- Not designed or rated as radiation hardened
- 24 pin SOP (SOP24-P-450) plastic package
- P-type bulk silicon

2. Pin Configuration

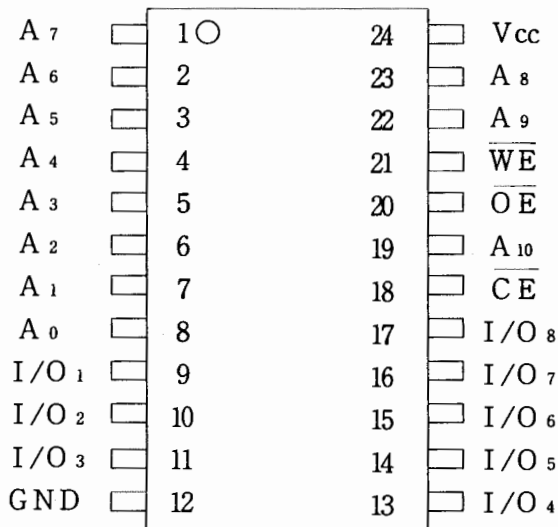

(Top View)

Pin Name	Function
A ₀ to A ₁₀	Address inputs
\overline{CE}	Chip enable
\overline{WE}	Write enable
\overline{OE}	Output enable
I/O ₁ to I/O ₈	Data inputs/outputs
V _{cc}	Power supply
GND	Ground

3. Truth Table

\overline{CE}	\overline{WE}	\overline{OE}	Mode	I/O ₁ to I/O ₈	Supply current
H	*	*	Standby	High impedance	Standby (I_{SB})
L	H	L	Read	Data output	Active (I_{CC})
L	*	H	Output disable	High impedance	Active (I_{CC})
L	L	*	Write	Data Input	Active (I_{CC})

(* = Don't Care, L=Low, H=High)

4. Block Diagram

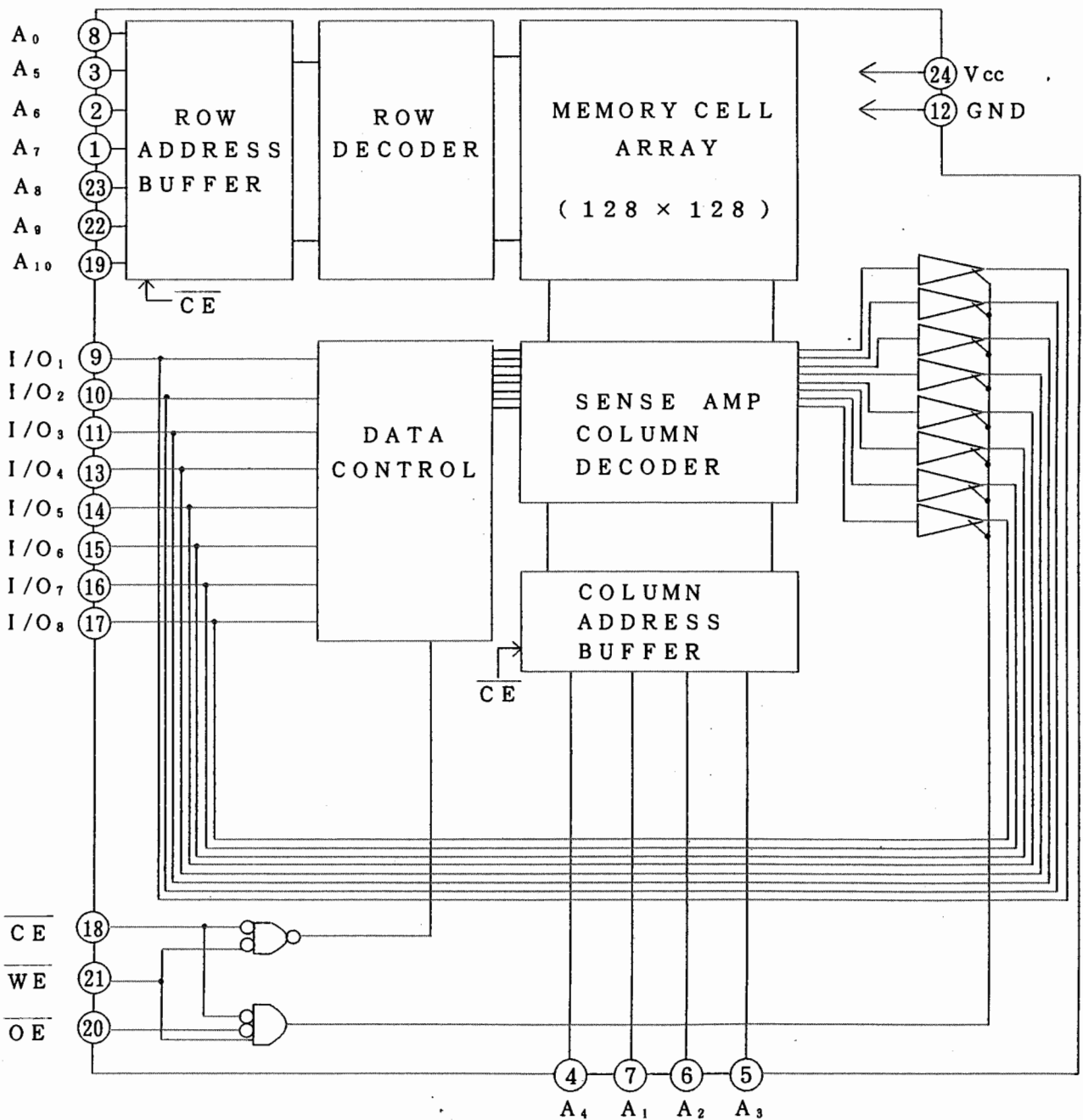

5. Absolute Maximum Ratings

Parameter	Symbol	Ratings	Unit
Supply voltage(*1)	V _{CC}	-0.3 to +7.0	V
Input voltage(*1)	V _{IN}	-0.3(*2) to V _{CC} +0.3	V
Operating temperature	T _{OPR}	0 to +70	°C
Storage temperature	T _{STG}	-55 to +150	°C

Note) *1. The maximum applicable voltage on any pin with respect to GND.

*2. Undershoot of -3.0V is allowed width of pulse below 50ns.

6. Recommended DC Operating Conditions

(T_a = 0°C to +70°C)

Parameter	Symbol	Min.	Typ.	Max.	Unit
Supply voltage	V _{CC}	4.5	5.0	5.5	V
Input voltage	V _{IH}	2.2		V _{CC} +0.3	V
	V _{IL}	-0.3(*3)		0.8	V

Note) *3. Undershoot of -3.0V is allowed width of pulse below 50ns.

7. DC Electrical Characteristics

(T_a = 0°C to +70°C, V_{CC} = 4.5V to 5.5V)

Parameter	Symbol	Conditions	Min.	Typ. (*4)	Max.	Unit
Input leakage current	I _{LI}	V _{IN} = 0V to V _{CC}	-1.0		1.0	μA
Output leakage current	I _{LO}	$\overline{CE} = V_{IH}$ V _{I/O} = 0V to V _{CC}	-1.0		1.0	μA
Operating supply current	I _{CC1}	$\overline{CE} = 0V$, Other input is 0V to V _{CC} I _{I/O} = 0mA, ($\overline{OE} = V_{CC}$)		25	30	mA
	I _{CC2}	$\overline{CE} = V_{IL}$, Other input is V _{IL} to V _{IH} I _{I/O} = 0mA, ($\overline{OE} = V_{IH}$)		30	40	mA
Standby current	I _{SB}	$\overline{CE} \geq V_{CC} - 0.2V$			0.2	μA
		Other input is 0V to V _{CC}			1.0	μA
Output voltage	V _{OL}	I _{OL} = 2.1mA			0.4	V
	V _{OH}	I _{OH} = -1.0mA	2.4			V

Note) *4. Typical values at V_{CC} = 5.0V, T_a = 25°C.

8. AC Electrical Characteristics

AC Test Conditions

Input pulse level	0.8 V to 2.2 V
Input rise and fall time	10 ns
Input and Output timing Ref. level	1.5 V
Output load	1 TTL + C _L (100 pF) (*5)

Note) *5. Including scope and jig capacitance.

Read cycle

(T_a = 0 °C to +70 °C, V_{CC} = 4.5 V to 5.5 V)

Parameter	Symbol	Min.	Max.	Unit	
Read cycle time	t _{RC}	100		ns	
Address access time	t _{AA}		100	ns	
CE access time	t _{ACE}		100	ns	
Output enable to output valid	t _{OE}		40	ns	
Output hold from address change	t _{OH}	10		ns	
CE Low to output active	t _{CLZ}	10		ns	*6
OE Low to output active	t _{OLZ}	10		ns	*6
CE High to output in High impedance	t _{CHZ}	0	40	ns	*6
OE High to output in High impedance	t _{OHZ}	0	40	ns	*6

Write cycle

(T_a = 0 °C to +70 °C, V_{CC} = 4.5 V to 5.5 V)

Parameter	Symbol	Min.	Max.	Unit	
Write cycle time	t _{WC}	100		ns	
CE Low to end of write	t _{CW}	80		ns	
Address valid to end of write	t _{AW}	80		ns	
Address setup time	t _{AS}	0		ns	
Write pulse width	t _{WP}	60		ns	
Write recovery time	t _{WR}	10		ns	
Input data setup time	t _{DW}	30		ns	
Input data hold time	t _{DH}	10		ns	
WE High to output active	t _{OW}	10		ns	*6
WE Low to output in High impedance	t _{WHZ}	0	30	ns	*6
OE High to output in High impedance	t _{OHZ}	0	40	ns	*6

Note) *6. Active output to High impedance and High impedance to output active tests specified for a ±200mV transition from steady state levels into the test load.

9. Data Retention Characteristics

(Ta= 0°C to +70°C)

Parameter	Symbol	Conditions	Min.	Typ. (*7)	Max.	Unit
Data Retention supply voltage	V _{CCDR}	$\overline{CE} \geq V_{CCDR} - 0.2V$	2.0		5.5	V
Data Retention supply current	I _{CCDR}	V _{CCDR} = 2.0V			0.2	μA
		$\overline{CE} \geq V_{CCDR} - 0.2V$			1.0	μA
Chip enable setup time	t _{CDR}		0			ns
Chip enable hold time	t _R		(*8) t _{RC}			ns

Note) *7. Typical values at Ta=25°C

*8. Read Cycle

10. Pin Capacitance

(Ta= 25°C, f = 1MHz)

Parameter	Symbol	Conditions	Min.	Typ.	Max.	Unit
Input capacitance	C _{IN}	V _{IN} = 0V			7	pF *9
I/O capacitance	C _{I/O}	V _{I/O} = 0V			10	pF *9

Note) *9. This parameter is sampled and not production tested.

11. Timing Chart

Read cycle timing chart (*10)

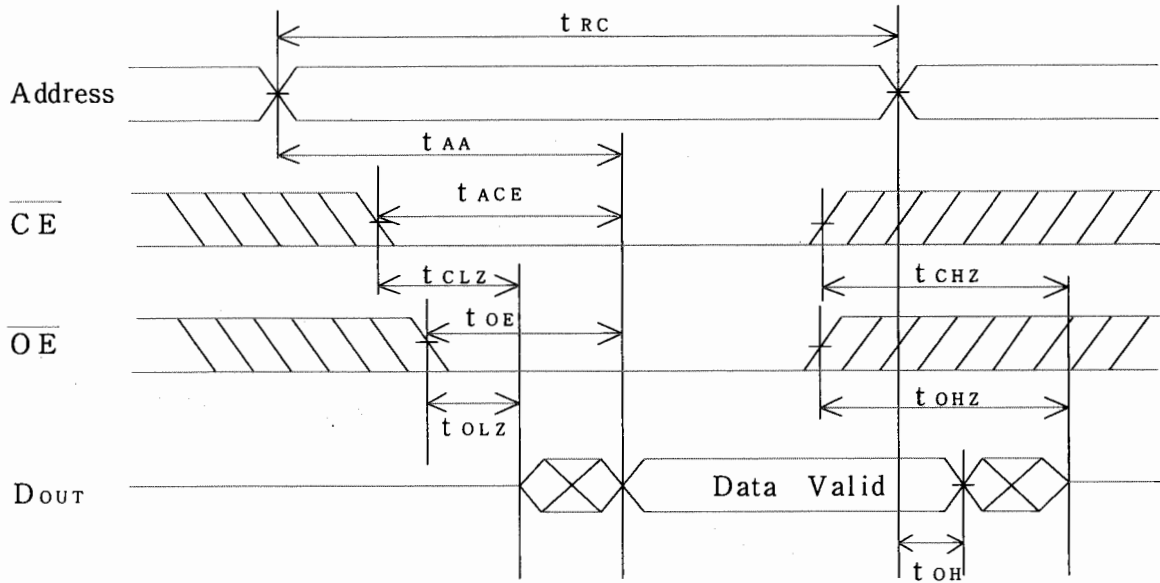

Note) *10. \overline{WE} is high for Read cycle.

Write cycle timing chart (\overline{OE} Controlled)

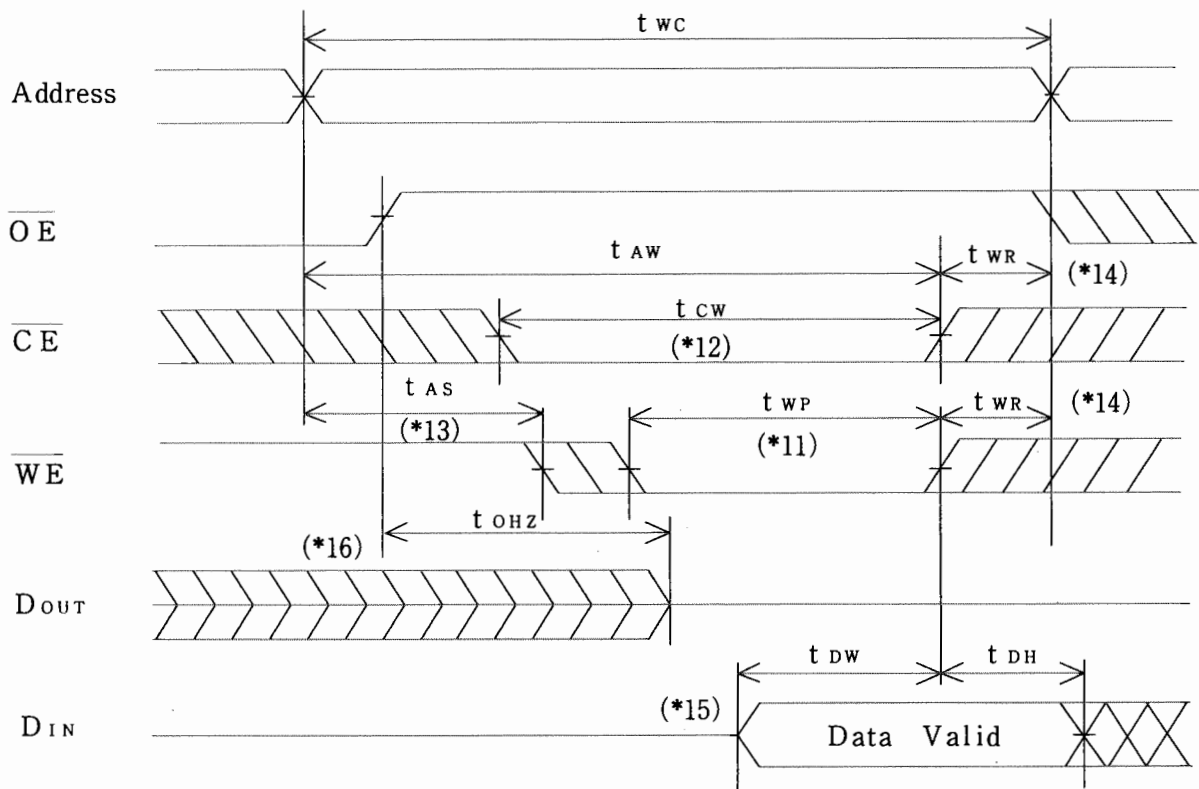

Write cycle timing chart (\overline{OE} Low fixed)

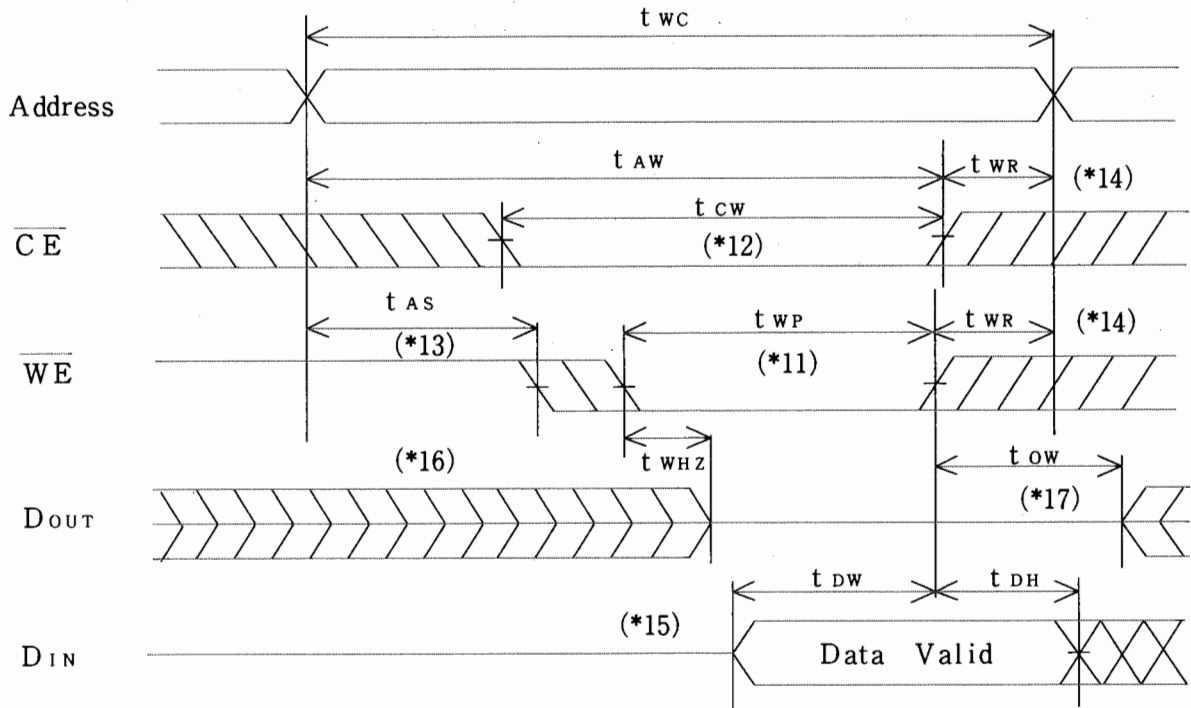

- Note) * 11. A write occurs during the overlap of a low \overline{CE} , and a low \overline{WE} .
 A write begins at the latest transition among \overline{CE} going low, and \overline{WE} going low.
 A write ends at the earliest transition among \overline{CE} going high, and \overline{WE} going high.
 t_{WP} is measured from the beginning of write to the end of write.
- * 12. t_{CW} is measured from the later of \overline{CE} going low to the end of write.
 - * 13. t_{AS} is measured from the address valid to the beginning of write.
 - * 14. t_{WR} is measured from the end of write to the address change.
 - * 15. During this period, I/O pins are in the output state, therefore the input signals of opposite phase to the outputs must not be applied.
 - * 16. If \overline{CE} goes low simultaneously with \overline{WE} going low or after \overline{WE} going low, the outputs remain in high impedance state.
 - * 17. If \overline{CE} goes high simultaneously with \overline{WE} going high or before \overline{WE} going high, the outputs remain in high impedance state.

Data Retention timing chart (\overline{CE} Controlled)

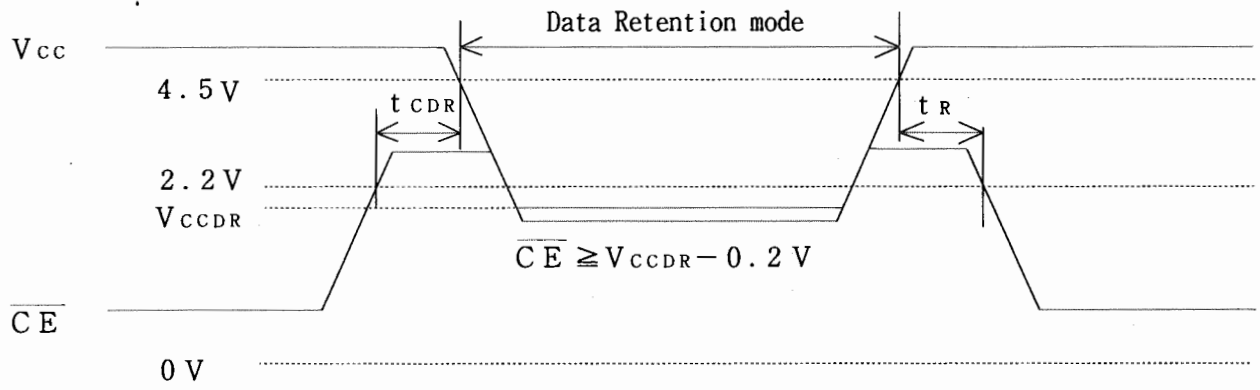

12 Package and packing specification

[Applicability]

This specification applies to IC package of the LEAD-FREE delivered as a standard specification.

1.Storage Conditions.

1-1.Storage conditions required before opening the dry packing.

- Normal temperature : 5~40°C
- Normal humidity : 80%(Relative humidity) max.
- "Humidity" means "Relative humidity"

1-2.Storage conditions required after opening the dry packing.

In order to prevent moisture absorption after opening, ensure the following storage conditions apply:

- (1) Storage conditions for one-time soldering. (Convection reflow^{*1}, IR/Convection reflow.^{*1}, or Manual soldering.)
 - Temperature : 5~25°C
 - Humidity : 60% max.
 - Period : 96 hours max. after opening.
- (2) Storage conditions for one-time soldering . (Solder dipping .)
 - Temperature : 5~25°C
 - Humidity : 60% Max.
 - Period : 96 hours max. after opening.
- (3) Storage conditions for two-time soldering. (Convection reflow^{*1}, IR/Convection reflow.^{*1})
 - a. Storage conditions following opening and prior to performing the 1st reflow.
 - Temperature : 5~25°C
 - Humidity : 60% max.
 - Period : 96 hours max. after opening.
 - b. Storage conditions following completion of the 1st reflow and prior to performing the 2nd reflow.
 - Temperature : 5~25°C
 - Humidity : 60% max.
 - Period : 96 hours max. after completion of the 1st reflow.

^{*1}:Air or nitrogen environment.

1-3.Temporary storage after opening.

To re-store the devices before soldering, do so only once and use a dry box or place desiccant (with a blue humidity indicator) with the devices and perform dry packing again using heat-sealing.

The storage period, temperature and humidity must be as follows :

(1) Storage temperature and humidity.

※1 : External atmosphere temperature and humidity of the dry packing.

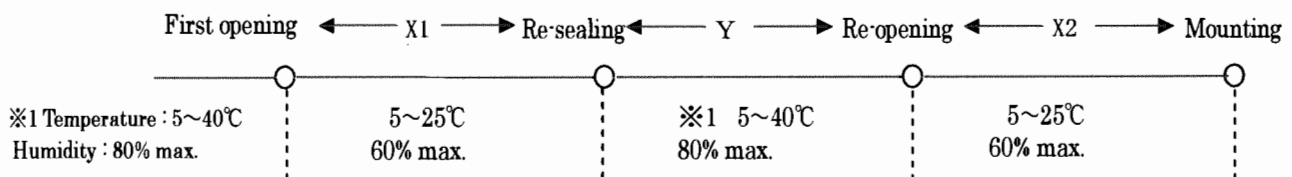

(2) Storage period.

- X1 + X2 : Refer to Section 1-2(1),(2), and (3)a , depending on the mounting method.
- Y : Two weeks max.

2. Baking Condition.

(1) Situations requiring baking before mounting.

- Storage conditions exceed the limits specified in Section 1-2 or 1-3.
- Humidity indicator in the desiccant was already red (pink) when opened.
(Also for re-opening.)

(2) Recommended baking conditions.

- Baking temperature and period : 120°C for 16~24 hours or 150°C for 5~10 hours.
- The above baking conditions do not apply since the magazines are not heat-resistant . Replace the devices on heat-resistant magazine .

(3) Storage after baking.

- After baking, store the devices in the environment specified in Section 1-2 and mount immediately.

3. Surface mount conditions.

The following soldering condition are recommended to ensure device quality.

3-1.Soldering.

(1) Convection reflow or IR/Convection. (one-time soldering or two-time soldering in air or nitrogen environment)

- Temperature and period :

A) Peak temperature.	250°C max.
B) Heating temperature.	40 to 60 seconds as 220°C
C) Preheat temperature.	It is 150 to 200°C, and is 120±30 seconds
D) Temperature increase rate.	It is 1 to 3°C/seconds
- Measuring point : IC package surface.
- Temperature profile :

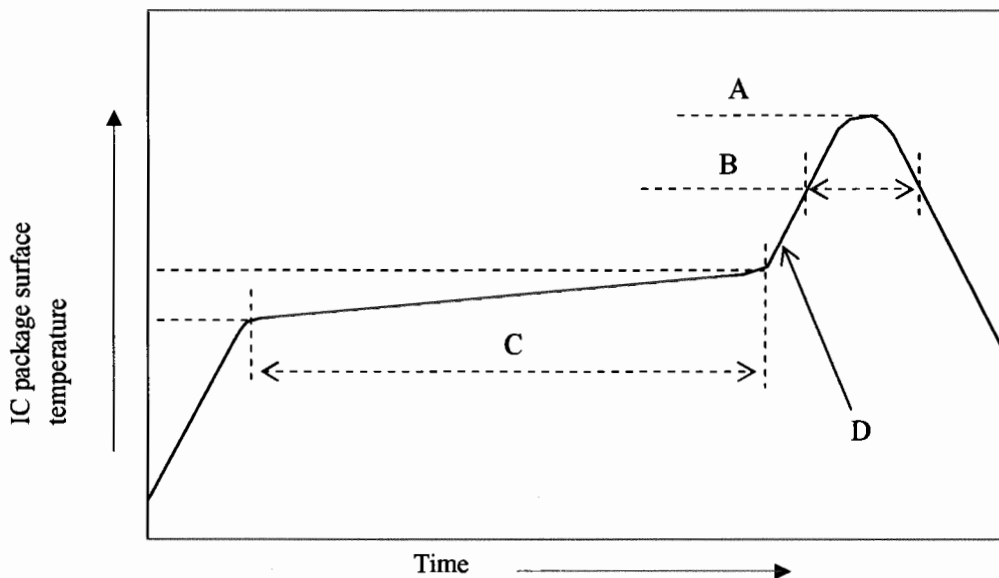

(2) Solder dipping. (one-time dipping only)

- Temperature and period :
 - A) Peak temperature. 260°C max. for 10 seconds Max.
 - B) Preheat temperature of 120 to 150°C for 120±60 seconds
- Measuring point :
 - A) Solder bath.
 - B) IC package surface.
- Temperature profile:

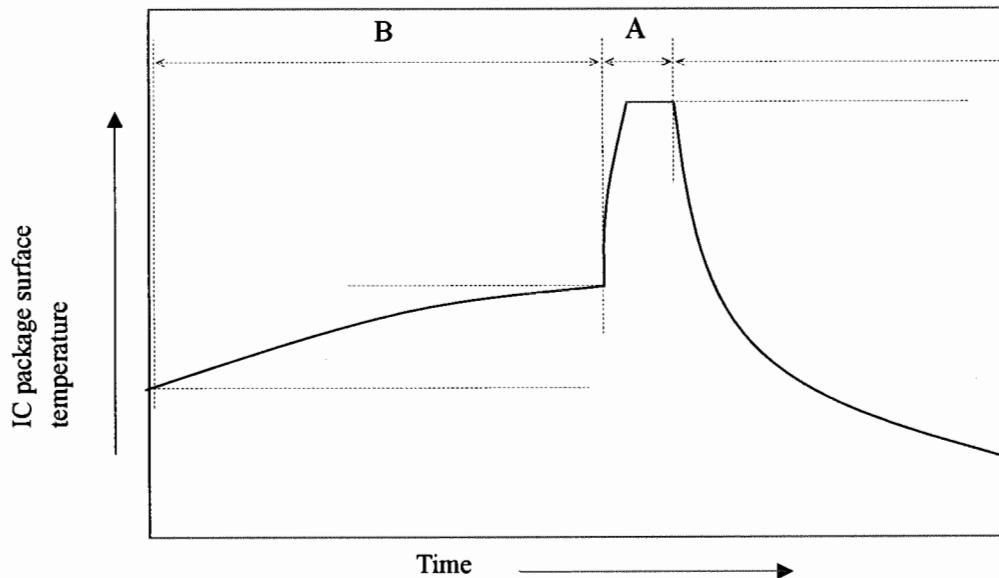

(3) Manual soldering (soldering iron) (one-time soldering only)

Soldering iron should only touch the IC's outer leads.

- Temperature and period :
 - 350°C max. for 3 seconds / pin max.
 - (Soldering iron should only touch the IC's outer leads.)
- Measuring point : Soldering iron tip.

4. Condition for removal of residual flux.

- (1) Ultrasonic washing power : 25 watts / liter max.
- (2) Washing time : Total 1 minute max.
- (3) Solvent temperature : 15~40°C

5. Package outline specification.

Refer to the attached drawing.

(Plastic body dimensions do not include burr of resin.)

The contents of LEAD-FREE TYPE application of the specifications. (*2)

6. Markings.

6-1. Marking details. (The information on the package should be given as follows.)

- (1) Product name : LH5116NA-10F
- (2) Company name : SHARP
- (3) Date code : (Example) YYWW XXX
 - YY → Denotes the production year. (Last two digits of the year.)
 - WW → Denotes the production week. (01 · 02 · ~ · 52 · 53)
 - XXX → Denotes the production ref. code (1~3 digits).
- (4) "JAPAN" indicates the country of origin.

6-2. Marking layout.

The layout is shown in the attached drawing.

(However, this layout does not specify the size of the marking character and marking position.)

*2 The contents of LEAD-FREE TYPE application of the specifications.

LEAD FINISH or BALL TYPE	LEAD-FREE TYPE (Sn-Bi)
DATE CODE	They are those with an underline.
The word of " LEAD FREE" is printed on the packing label	Printed

(Note) It is those with an underline printing in a date code because of a LEAD-FREE type.

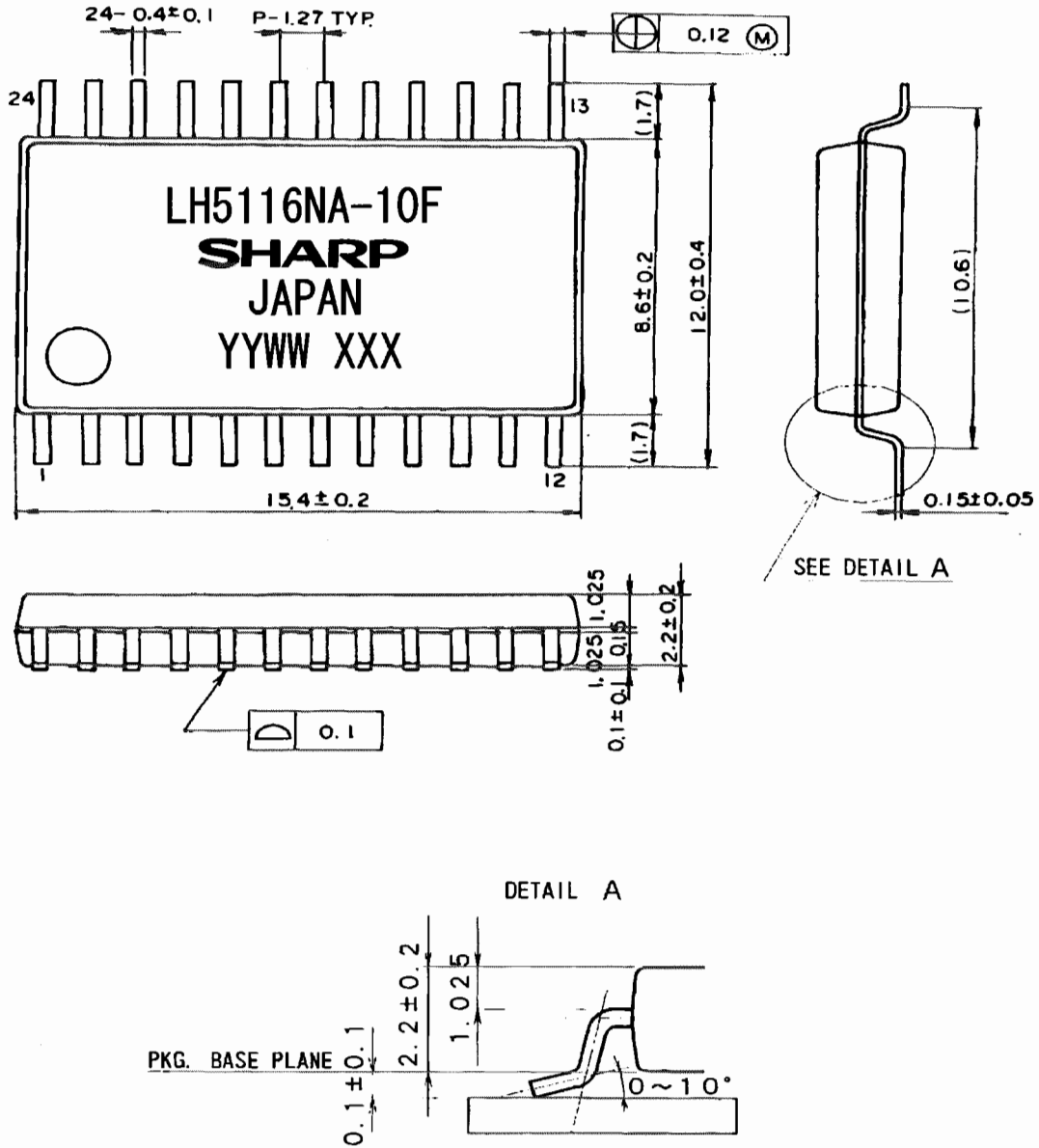

SOP024-P-0450-AA941

LEAD TYPE	LEAD FINISH		LEAD MATERIAL
	Sn-Bi PLATING		42Alloy
NAME	SOP024-P-0450		NOTE : Plastic body dimensions do not include burr of resin.
DRAWING NO.	AA941	UNIT : mm	

7. Packing Specifications (Dry packing for surface mount packages.)

7-1. Packing materials.

Material name	Material specifications	Purpose
Inner carton	Gardboard (1200 devices / inner carton max.)	Packing the devices.
Magazine	Anti-static treated plastic (30 devices / magazine)	Securing the devices.
Stopper	Plastic or rubber	Securing the devices.
Cap	Plastic (2 caps / bag)	Securing the magazine.
Laminated aluminum bag	Aluminum polyethylene	Keeping the devices dry.
Desiccant	Silica gel	Keeping the devices dry.
Label	Paper	Indicates part number, quantity, and packed date.
Outer carton	Gardboard (4800 devices / outer carton max.)	Outer packing.

(Devices must be placed on the magazine in the same direction.)

7-2. Outline dimension of magazine.

Refer to the attached drawing.

7-3. Outline dimension of carton.

Refer to the attached drawing.

8. Precautions for use.

- (1) Opening must be done on an anti-ESD treated workbench.
All workers must also have undergone anti-ESD treatment.
- (2) The magazines have undergone either conductive or anti-ESD treatment.
If another magazine is used, make sure it has also undergone conductive or anti-ESD treatment.
- (3) The devices should be mounted within one year of the date of delivery.

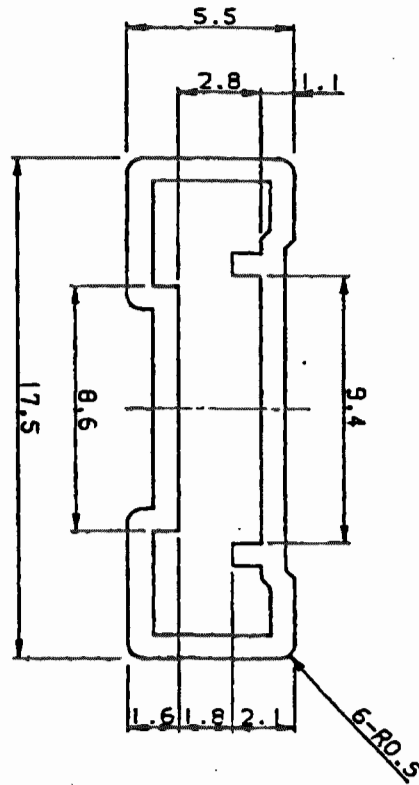
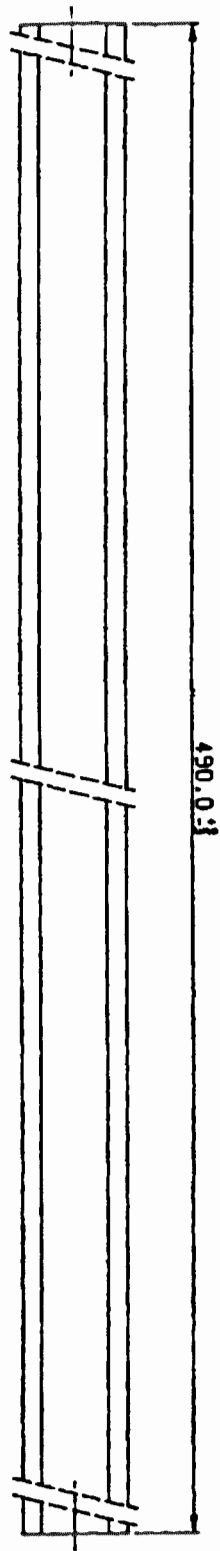

注記 : マガジン (スリーブ) 両側のストッパーは、ゴムストッパーとする。指示無き寸法公差は全て±0.4mmとする。

NOTES : Stopper which is set at the both ends of magazine (sleeve) is made of rubber.

All tolerances are ±0.4mm unless otherwise specified.

名称 Name	SOP28SPN-A2			備考 Note
Drawing no.	CV607	単位 Unit	mm	

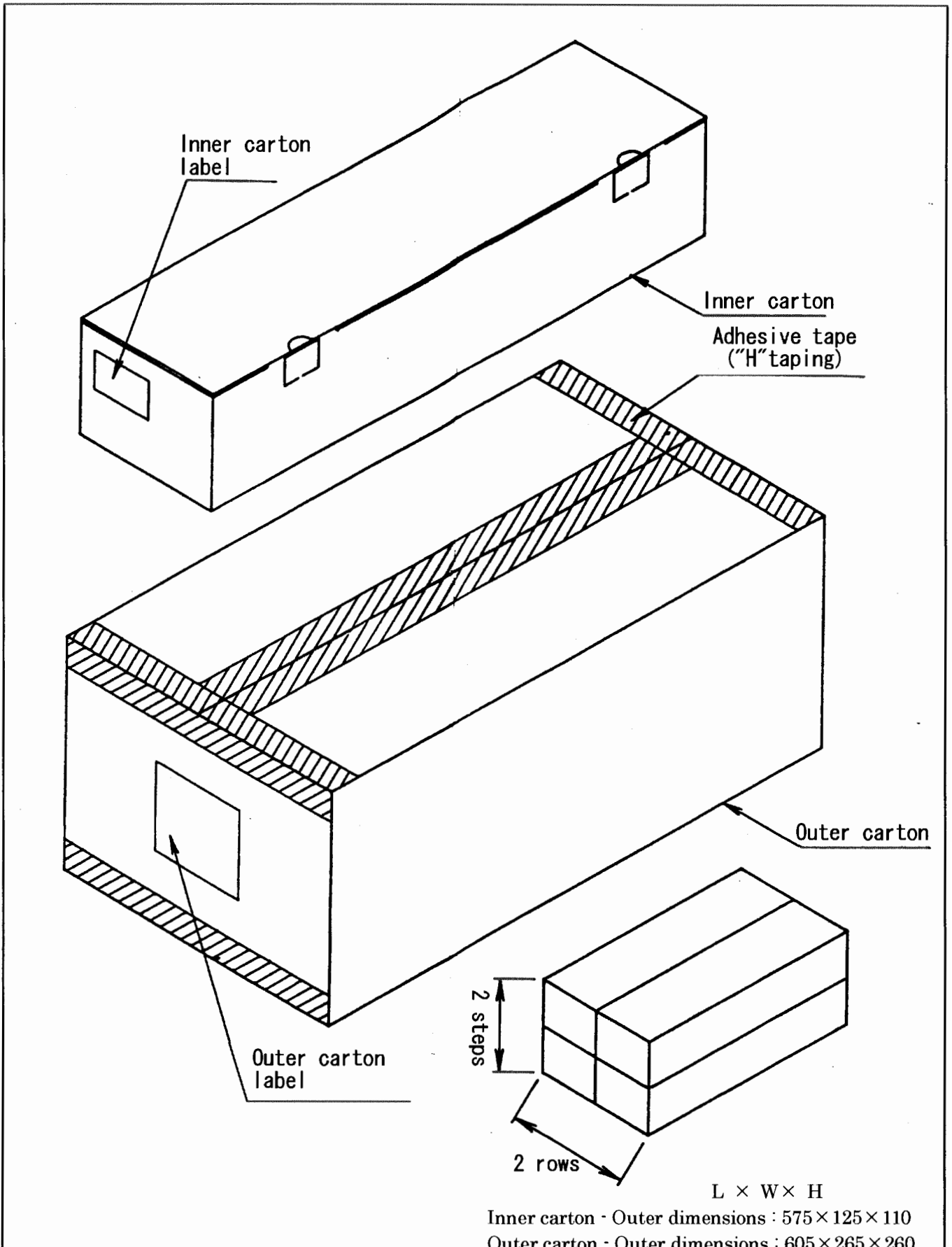

名称 NAME	Packing specifications			備考 NOTE	出荷数量が端数の場合、本仕様と異なることがあります。 There is a possibility different from this specification when the number of shipments is fractions.
DRAWING NO.	BJ535	単位 UNIT	mm		

(Note) The <LEAD-FREE> display shows a lead-free article.

Inner carton label

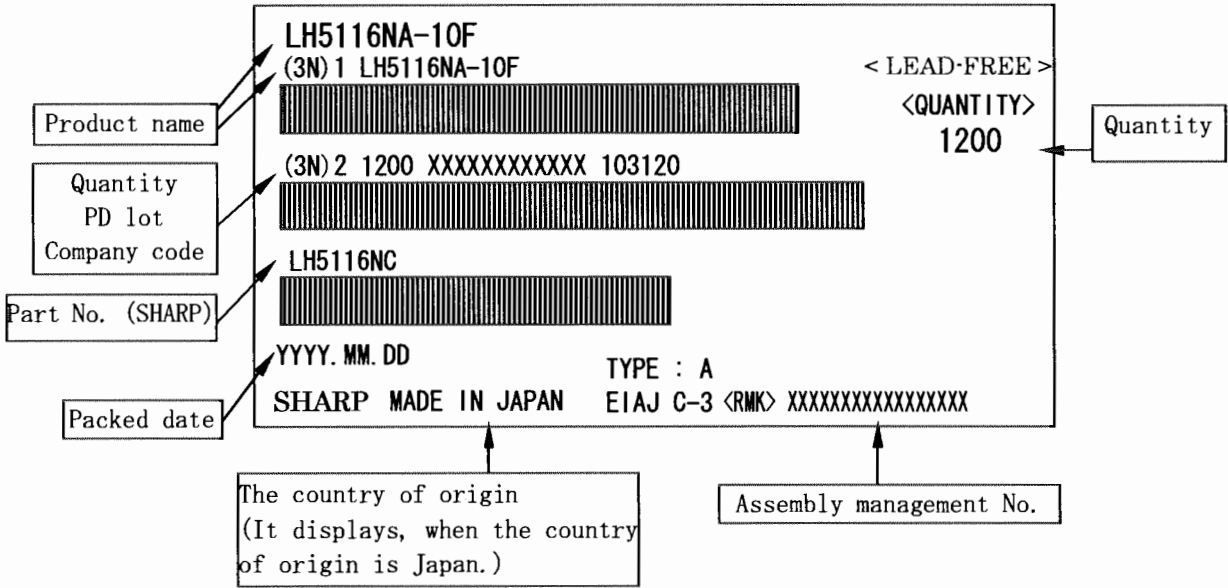

Outer carton label

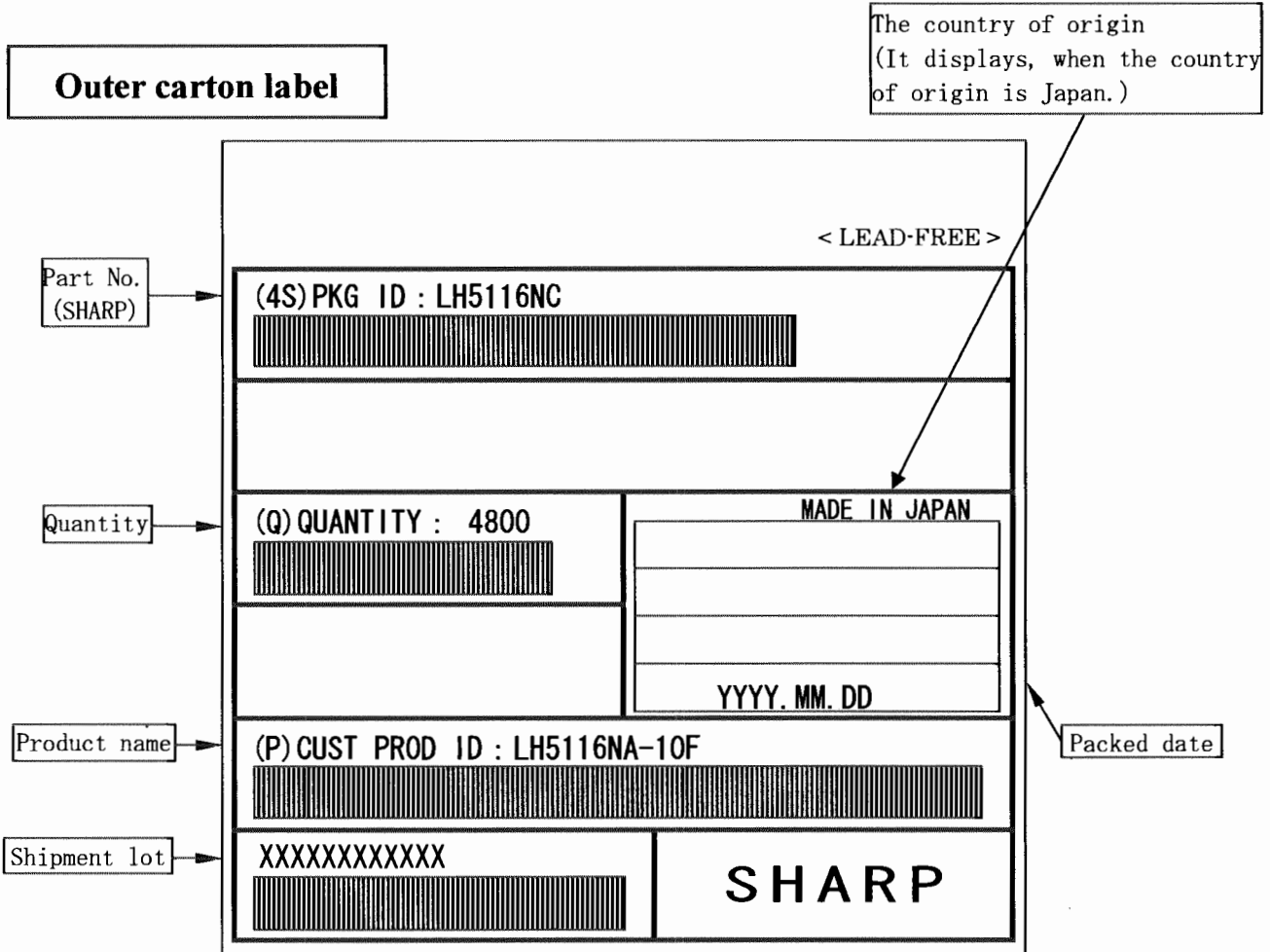

(Former) EIAJ B Standard conforming

SPECIFICATIONS ARE SUBJECT TO CHANGE WITHOUT NOTICE.

Suggested applications (if any) are for standard use; See Important Restrictions for limitations on special applications. See Limited Warranty for SHARP's product warranty. The Limited Warranty is in lieu, and exclusive of, all other warranties, express or implied. ALL EXPRESS AND IMPLIED WARRANTIES, INCLUDING THE WARRANTIES OF MERCHANTABILITY, FITNESS FOR USE AND FITNESS FOR A PARTICULAR PURPOSE, ARE SPECIFICALLY EXCLUDED. In no event will SHARP be liable, or in any way responsible, for any incidental or consequential economic or property damage.

SHARP®

NORTH AMERICA

SHARP Microelectronics of the Americas
5700 NW Pacific Rim Blvd.
Camas, WA 98607, U.S.A.
Phone: (1) 360-834-2500
Fax: (1) 360-834-8903
Fast Info: (1) 800-833-9437
www.sharpsma.com

EUROPE

SHARP Microelectronics Europe
Division of Sharp Electronics (Europe) GmbH
Sonninstrasse 3
20097 Hamburg, Germany
Phone: (49) 40-2376-2286
Fax: (49) 40-2376-2232
www.sharpsme.com

JAPAN

SHARP Corporation
Electronic Components & Devices
22-22 Nagaike-cho, Abeno-Ku
Osaka 545-8522, Japan
Phone: (81) 6-6621-1221
Fax: (81) 6117-725300/6117-725301
www.sharp-world.com

TAIWAN

SHARP Electronic Components
(Taiwan) Corporation
8F-A, No. 16, Sec. 4, Nanking E. Rd.
Taipei, Taiwan, Republic of China
Phone: (886) 2-2577-7341
Fax: (886) 2-2577-7326/2-2577-7328

SINGAPORE

SHARP Electronics (Singapore) PTE., Ltd.
438A, Alexandra Road, #05-01/02
Alexandra Technopark,
Singapore 119967
Phone: (65) 271-3566
Fax: (65) 271-3855

KOREA

SHARP Electronic Components
(Korea) Corporation
RM 501 Geosung B/D, 541
Dohwa-dong, Mapo-ku
Seoul 121-701, Korea
Phone: (82) 2-711-5813 ~ 8
Fax: (82) 2-711-5819

CHINA

SHARP Microelectronics of China
(Shanghai) Co., Ltd.
28 Xin Jin Qiao Road King Tower 16F
Pudong Shanghai, 201206 P.R. China
Phone: (86) 21-5854-7710/21-5834-6056
Fax: (86) 21-5854-4340/21-5834-6057

Head Office:

No. 360, Bashen Road,
Xin Development Bldg. 22
Waigaoqiao Free Trade Zone Shanghai
200131 P.R. China
Email: smc@china.global.sharp.co.jp

HONG KONG

SHARP-ROXY (Hong Kong) Ltd.
3rd Business Division,
17/F, Admiralty Centre, Tower 1
18 Harcourt Road, Hong Kong
Phone: (852) 28229311
Fax: (852) 28660779
www.sharp.com.hk

Shenzhen Representative Office:

Room 13B1, Tower C,
Electronics Science & Technology Building
Shen Nan Zhong Road
Shenzhen, P.R. China
Phone: (86) 755-3273731
Fax: (86) 755-3273735