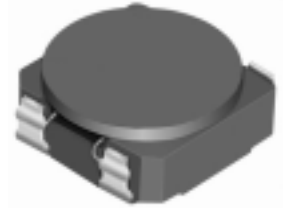
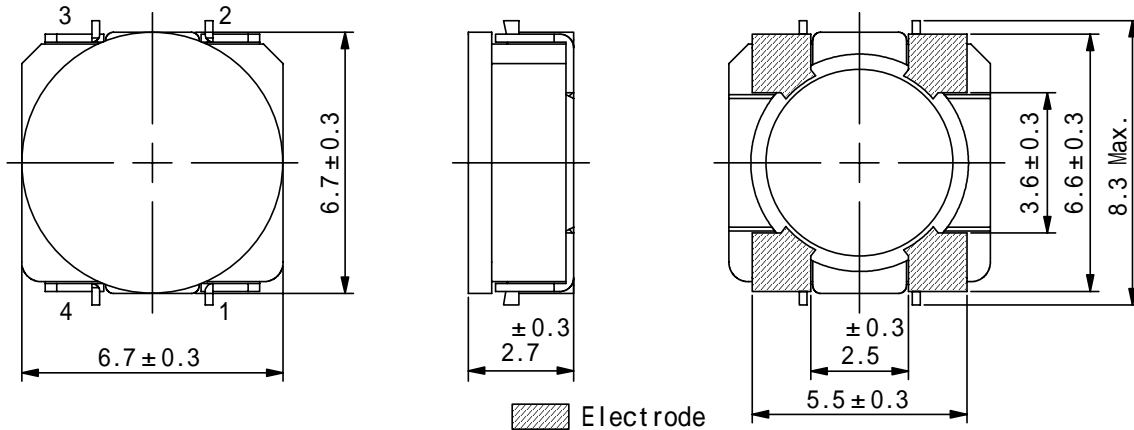
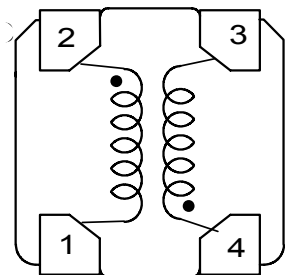

Type: CLS6D28
Description

- 4 Terminal pins' type gives a flexible design as inductors or transformers.
- Can also be used as a coupled inductor, two single inductors connected in parallel, as 1:1 transformer or as an autotransformer when connected in series.
- Core material: Ferrite.
- Custom design is available.

Feature

- Max. Operating frequency: 1MHz.
- 2 in 1 Coils for high efficiency up-down DC-DC converters.(SEPIC, Zeta, Cuk converter).
- Storage temperature range: -40 ~+105 .
- Operating temperature range: -40 ~+105 (including coil's self-heat).
- Product weight: 520mg(Ref.).
- Ideally used in the power supply for DSC, Note PC, DVC and W-LED backlighting.
- RoHS Compliance.

Dimensions (mm)

Schematics (Bottom)

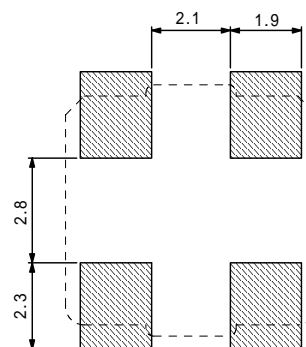
“●” indicates polarity.

Land Pattern (mm)

Type: CLS6D28
Specification

Part No.	Stamp	Inductance [Within]	D.C.R. [Max.] (m)		Saturation Current (A) ²				Temperature Rise current (A) ³	
			(at 20) 1		In parallel		In series		In parallel	In series
			(2-1)	(4-3)	at 20	at 100	at 20	at 100		
CLS6D28NP-1R2N	1R2	1.2μH±35%	21(16)	25(19)	4.00	3.00	2.00	1.40	4.40	2.40
CLS6D28NP-1R8N	1R8	1.8μH±35%	26(20)	31(24)	3.30	2.50	1.60	1.20	4.00	2.20
CLS6D28NP-2R5N	2R5	2.5μH±30%	31(24)	36(28)	2.70	2.10	1.35	1.00	3.60	2.00
CLS6D28NP-3R3N	3R3	3.3μH±30%	35(27)	46(35)	2.40	1.80	1.20	0.90	3.20	1.60
CLS6D28NP-4R7N	4R7	4.7μH±30%	47(36)	63(48)	2.10	1.60	1.05	0.80	2.40	1.20
CLS6D28NP-6R8N	6R8	6.8μH±30%	78(60)	98(75)	1.70	1.30	0.85	0.70	2.00	0.95
CLS6D28NP-10ØN	100	10μH±30%	100(75)	125(95)	1.44	1.05	0.72	0.55	1.80	0.85
CLS6D28NP-15ØN	150	15μH±30%	145(110)	180(140)	1.15	0.90	0.58	0.45	1.40	0.70
CLS6D28NP-22ØN	220	22μH±30%	275(210)	340(260)	0.92	0.65	0.45	0.36	1.10	0.52
CLS6D28NP-33ØN	330	33μH±30%	340(260)	430(330)	0.75	0.54	0.38	0.28	0.95	0.42
CLS6D28NP-47ØN	470	47μH±30%	545(420)	690(530)	0.63	0.44	0.32	0.24	0.80	0.36
CLS6D28NP-68ØN	680	68μH±30%	650(500)	845(650)	0.53	0.38	0.27	0.20	0.72	0.32
CLS6D28NP-1Ø1N	101	100μH±30%	1090(840)	1375(1060)	0.44	0.32	0.22	0.18	0.60	0.27
CLS6D28NP-121N	121	120μH±30%	1200(930)	1500(1200)	0.40	0.28	0.19	0.15	0.54	0.24

Description of Part Name

CLS6D28NP -1R2N

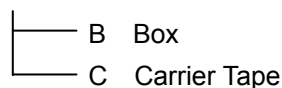

1. () typical value.

2. Saturation Current: The DC current at which the inductance decreases to 90% of it's nominal value.

3. Temperature rise current: The DC current at which the temperature rise is t = 40 .(Ta = 20).

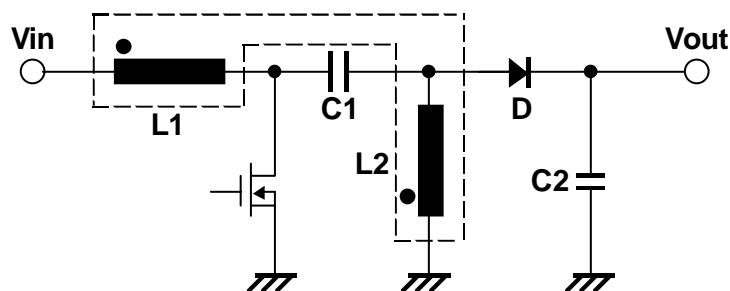
Typical SEPIC Schematic

Type: CLS6D28

Typical L Vs Current

Parallel mode L vs I_{dc} (at 20 °C) (REF.)

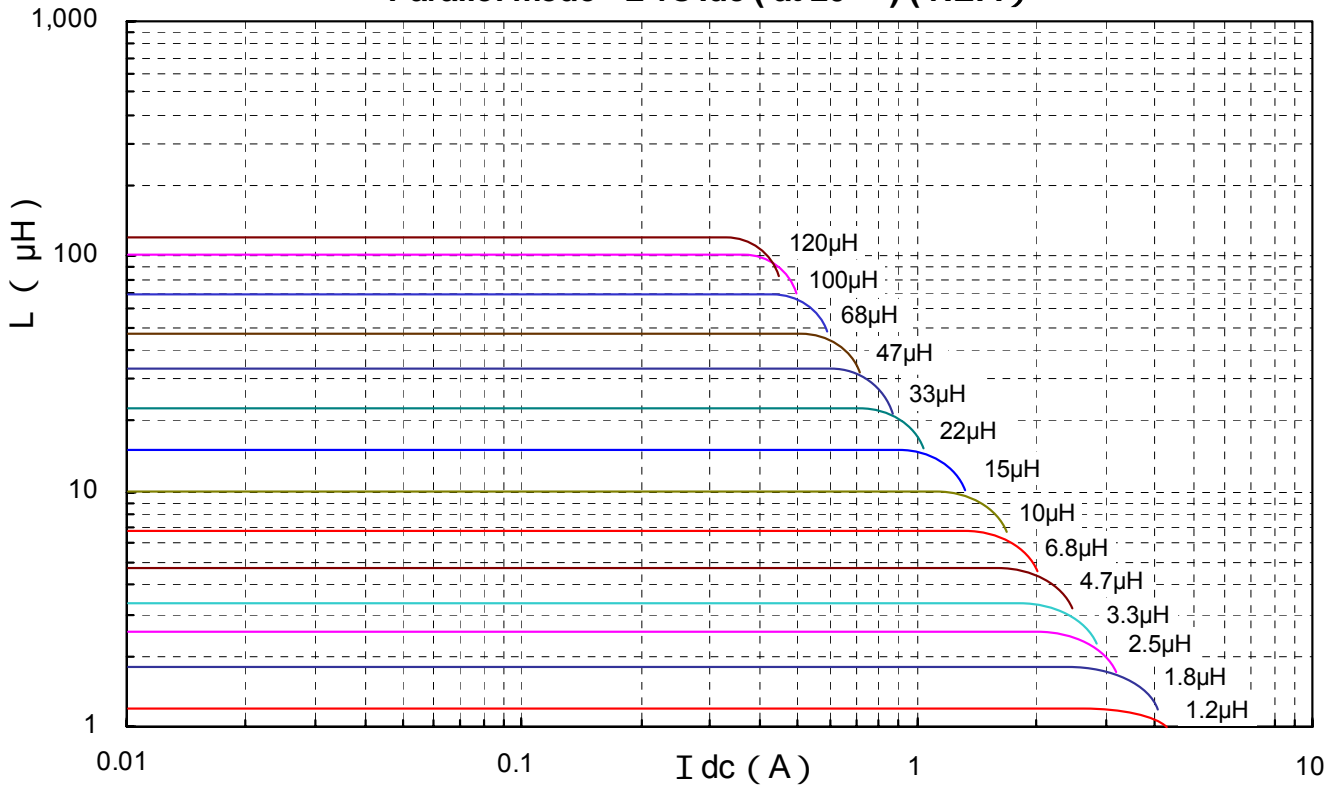

Series mode L vs I_{dc} (at 20 °C) (REF.)

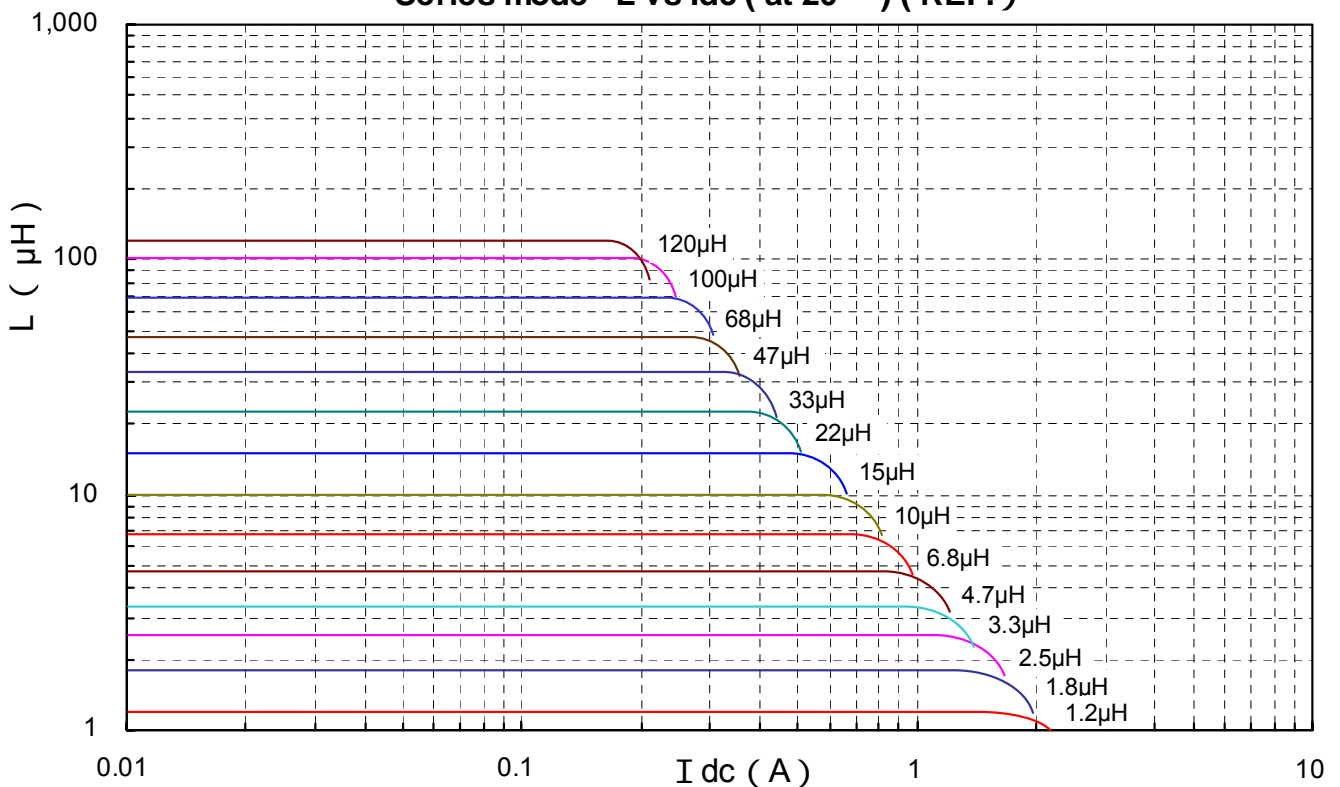

Type: CLS6D28

Recommendation Reflow Condition

Heat Endurance Test

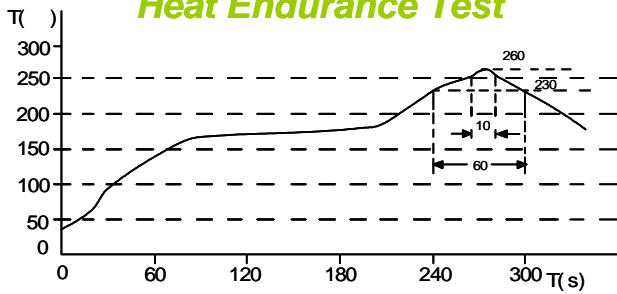

Temperature Chart

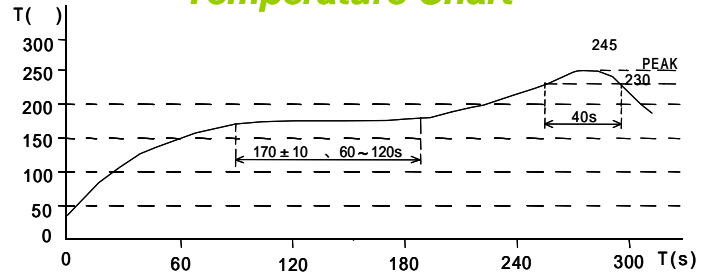

Packaging with Embossed Tape and Reel

Qty.: 1500pcs/reel

