

# CAB450M12XM3

## 1200V, 450A All-Silicon Carbide Conduction Optimized, Half-Bridge Module

|          |               |
|----------|---------------|
| $V_{DS}$ | <b>1200 V</b> |
| $I_{DS}$ | <b>450 A</b>  |

### Technical Features

- High Power Density Footprint
- High Junction Temperature (175 °C) Operation
- Low Inductance (6.7 nH) Design
- Implements Conduction Optimized Third Generation SiC MOSFET Technology
- Silicon Nitride Insulator and Copper Baseplate

### Applications

- Motor & Traction Drives
- Vehicle Fast Chargers
- Uninterruptable Power Supplies
- Smart-Grid / Grid-Tied Distributed Generation

### Package 80 x 53 x 19 mm

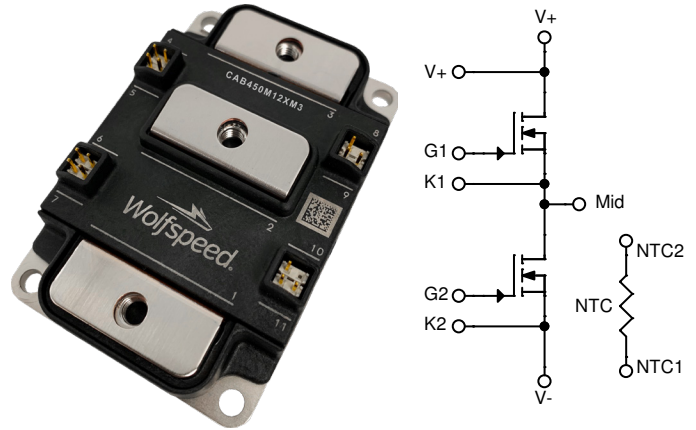

### System Benefits

- Terminal layout allows for direct bus bar connection without bends or bushings enabling a simple, low inductance design.
- Isolated integrated temperature sensing enables high-level temperature protection.
- Dedicated drain Kelvin pin enables direct voltage sensing for gate driver overcurrent protection.

### Key Parameters ( $T_c = 25^\circ\text{C}$ unless otherwise specified)

| Symbol             | Parameter   | Min. | Typ. | Max. | Unit             | Test Conditions  | Note    |
|--------------------|---|------|------|------|------------------|--|---------|
| $V_{DS\ max}$      | Drain-Source Voltage  |      |      | 1200 | V                |  |         |
| $V_{GS\ max}$      | Gate-Source Voltage, Maximum Value                              | -4   |      | +19  |                  | AC frequency $\geq 1\text{Hz}$ .   | Note 1  |
| $V_{GS\ op}$       | Gate-Source Voltage, Recommended Op. Value                      | -4   |      | +15  |                  | Static   |         |
| $I_{DS}$           | DC Continuous Drain Current                                     |      |      | 450  | A                | $V_{GS} = 15\text{V}$ , $T_c = 25^\circ\text{C}$ , $T_{vj} \leq 175^\circ\text{C}$   | Fig. 20 |
|                    |   |      | 409  |      |                  | $V_{GS} = 15\text{V}$ , $T_c = 90^\circ\text{C}$ , $T_{vj} \leq 175^\circ\text{C}$   | Note 2  |
| $I_{SD}$           | DC Source-Drain Current   |      |      | 450  |                  | $V_{GS} = 15\text{V}$ , $T_c = 25^\circ\text{C}$ , $T_{vj} \leq 175^\circ\text{C}$   |         |
| $I_{SD\ BD}$       | DC Source-Drain Current (Body Diode)                            |      | 225  |      |                  | $V_{GS} = -4\text{V}$ , $T_c = 25^\circ\text{C}$ , $T_{vj} \leq 175^\circ\text{C}$   |         |
| $I_{DS\ (pulsed)}$ | Maximum Pulsed Drain-Source Current                             |      |      | 900  |                  | $t_{Pmax}$ limited by $T_{jmax}$<br>$V_{GS} = 15\text{V}$ , $T_c = 25^\circ\text{C}$ |         |
| $I_{SD\ (pulsed)}$ | Maximum Pulsed Source-Drain Current                             |      |      | 900  |                  |  |         |
| $T_{Vj\ op}$       | Maximum Virtual Junction Temperature under Switching Conditions | -40  |      | 175  | $^\circ\text{C}$ |  |         |

Note 1 If MOSFET body diode is not used,  $V_{GS\ max} = -8/+19\text{V}$

Note 2 Assumes  $R_{THJC} = 0.11^\circ\text{C/W}$  and  $R_{DS(on)} = 4.6\text{m}\Omega$ . Calculate  $P_D = (T_{vj} - T_c) / R_{THJC}$ . Calculate  $I_{D\_MAX} = \sqrt{(P_D / R_{DS(on)})}$

### MOSFET Characteristics (Per Position) ( $T_c = 25^\circ\text{C}$ unless otherwise specified)

| Symbol        | Parameter   | Min. | Typ.                 | Max. | Unit                      | Test Conditions  | Note               |
|---------------|---|------|----------------------|------|---------------------------|--|--------------------|
| $V_{(BR)DSS}$ | Drain-Source Breakdown Voltage  | 1200 |                      |      | V                         | $V_{GS} = 0\text{ V}, I_D = 200\ \mu\text{A}$  |                    |
| $V_{GS(th)}$  | Gate Threshold Voltage  | 1.8  | 2.5                  | 3.6  |                           | $V_{DS} = V_{GS}, I_D = 132\ \text{mA}$  |                    |
|               |   |      | 2.0                  |      |                           | $V_{DS} = V_{GS}, I_D = 132\ \text{mA}, T_J = 175^\circ\text{C}$   |                    |
| $I_{DSS}$     | Zero Gate Voltage Drain Current   |      | 5                    | 200  | $\mu\text{A}$             | $V_{GS} = 0\ \text{V}, V_{DS} = 1200\ \text{V}$  |                    |
| $I_{GSS}$     | Gate-Source Leakage Current   |      | 0.05                 | 1.3  |                           | $V_{GS} = 15\ \text{V}, V_{DS} = 0\ \text{V}$  |                    |
| $R_{DS(on)}$  | Drain-Source On-State Resistance (Devices Only)   |      | 2.6                  | 3.7  | m $\Omega$                | $V_{GS} = 15\ \text{V}, I_D = 450\ \text{A}$   | Fig. 2             |
|               |   |      | 4.6                  |      |                           | $V_{GS} = 15\ \text{V}, I_D = 450\ \text{A}, T_J = 175^\circ\text{C}$  | Fig. 3             |
| $g_{fs}$      | Transconductance  |      | 355                  |      | S                         | $V_{DS} = 20\ \text{V}, I_{DS} = 450\ \text{A}$  | Fig. 4             |
|               |   |      | 360                  |      |                           | $V_{DS} = 20\ \text{V}, I_{DS} = 450\ \text{A}, T_J = 175^\circ\text{C}$   |                    |
| $E_{On}$      | Turn-On Switching Energy, $T_J = 25^\circ\text{C}$<br>$T_J = 125^\circ\text{C}$<br>$T_J = 175^\circ\text{C}$  |      | 11.0<br>11.7<br>13.0 |      | mJ                        | $V_{DS} = 600\ \text{V},$<br>$I_D = 450\ \text{A},$<br>$V_{GS} = -4\ \text{V}/15\ \text{V},$<br>$R_{G(ext)} = 0.0\ \Omega,$<br>$L = 13.6\ \mu\text{H}$ | Fig. 11<br>Fig. 13 |
| $E_{Off}$     | Turn-Off Switching Energy, $T_J = 25^\circ\text{C}$<br>$T_J = 125^\circ\text{C}$<br>$T_J = 175^\circ\text{C}$ |      | 10.1<br>11.3<br>12.1 |      |                           |  |                    |
| $R_{G(int)}$  | Internal Gate Resistance  |      | 2.5                  |      | $\Omega$                  |  |                    |
| $C_{iss}$     | Input Capacitance   |      | 38.0                 |      | nF                        | $V_{GS} = 0\ \text{V}, V_{DS} = 800\ \text{V},$<br>$V_{AC} = 25\ \text{mV}, f = 100\ \text{kHz}$   | Fig. 9             |
| $C_{oss}$     | Output Capacitance  |      | 1.5                  |      |                           |  |                    |
| $C_{rss}$     | Reverse Transfer Capacitance  |      | 90                   |      |                           |  |                    |
| $Q_{GS}$      | Gate to Source Charge   |      | 355                  |      | nC                        | $V_{DS} = 800\ \text{V}, V_{GS} = -4\ \text{V}/15\ \text{V}$<br>$I_D = 450\ \text{A}$<br>Per IEC60747-8-4 pg 21  |                    |
| $Q_{GD}$      | Gate to Drain Charge  |      | 500                  |      |                           |  |                    |
| $Q_G$         | Total Gate Charge   |      | 1330                 |      |                           |  |                    |
| $R_{thJC}$    | FET Thermal Resistance, Junction to Case  |      | 0.11                 | 0.13 | $^\circ\text{C}/\text{W}$ |  | Fig. 17            |

### Body Diode Characteristics (Per Position) ( $T_c = 25^\circ\text{C}$ unless otherwise specified)

| Symbol   | Parameter  | Min. | Typ.              | Max. | Unit | Test Conditions  | Note    |
|----------|--|------|-------------------|------|------|--|---------|
| $V_{SD}$ | Body Diode Forward Voltage   |      | 4.7               |      | V    | $V_{GS} = -4\ \text{V}, I_{SD} = 450\ \text{A}$  | Fig. 7  |
|          |  |      | 4.2               |      |      | $V_{GS} = -4\ \text{V}, I_{SD} = 450\ \text{A}, T_J = 175^\circ\text{C}$   |         |
| $t_{rr}$ | Reverse Recovery Time  |      | 52                |      | ns   | $V_{GS} = -4\ \text{V}, I_{SD} = 450\ \text{A}, V_R = 600\ \text{V}$<br>$di/dt = 8\ \text{A/ns}, T_J = 175^\circ\text{C}$                    |         |
| $Q_{rr}$ | Reverse Recovery Charge  |      | 6.6               |      |      |  |         |
| $I_{rr}$ | Peak Reverse Recovery Current  |      | 195               |      |      |  |         |
| $E_{rr}$ | Reverse Recovery Energy $T_J = 25^\circ\text{C}$<br>$T_J = 125^\circ\text{C}$<br>$T_J = 175^\circ\text{C}$ |      | 0.2<br>1.1<br>1.9 |      | mJ   | $V_{DS} = 600\ \text{V}, I_D = 450\ \text{A},$<br>$V_{GS} = -4\ \text{V}/15\ \text{V}, R_{G(ext)} = 0.0\ \Omega,$<br>$L = 13.6\ \mu\text{H}$ | Fig. 14 |

## Temperature Sensor (NTC) Characteristics

| Symbol          | Parameter                    | Min. | Typ. | Max. | Unit | Test Conditions          |
|-----------------|------------------------------|------|------|------|------|--------------------------|
| R <sub>25</sub> | Rated Resistance             |      | 4.7  |      | kΩ   | T <sub>NTC</sub> = 25 °C |
| ΔR/R            | Tolerance of R <sub>25</sub> |      |      | ±1   | %    |                          |
| P <sub>25</sub> | Maximum Power Dissipation    |      |      | 50   | mW   |                          |

Steinhart-Hart Modified Coefficients for R/T Computation:  $\frac{1}{T} = A + B \times \ln\left(\frac{R}{R_{25}}\right) + C \times \ln^2\left(\frac{R}{R_{25}}\right) + D \times \ln^3\left(\frac{R}{R_{25}}\right)$

|                          | A          | B          | C          | D          |
|--------------------------|------------|------------|------------|------------|
| T <sub>NTC</sub> < 25 °C | 3.3540E-03 | 3.0013E-04 | 5.0852E-06 | 2.1877E-07 |
| T <sub>NTC</sub> ≥ 25 °C | 3.3540E-03 | 3.0013E-04 | 5.0852E-06 | 2.1877E-07 |

## Module Physical Characteristics

| Symbol             | Parameter                  | Min. | Typ. | Max. | Unit | Test Conditions                 |
|--------------------|----------------------------|------|------|------|------|---------------------------------|
| R <sub>3-1</sub>   | Package Resistance, M1     |      | 0.72 |      | mΩ   | T <sub>c</sub> = 125 °C, Note 3 |
| R <sub>1-2</sub>   | Package Resistance, M2     |      | 0.63 |      |      | T <sub>c</sub> = 125 °C, Note 3 |
| L <sub>Stray</sub> | Stray Inductance           |      | 6.7  |      | nH   | Between Terminals 2 and 3       |
| T <sub>c</sub>     | Case Temperature           | -40  |      | 125  | °C   |                                 |
| W                  | Weight                     |      | 175  |      | g    |                                 |
| M <sub>s</sub>     | Mounting Torque            | 2.0  | 3.0  | 4.0  | N-m  | Baseplate, M4 bolts             |
|                    |                            | 2.0  | 4.0  | 5.0  |      | Power Terminals, M5 bolts       |
| V <sub>isol</sub>  | Case Isolation Voltage     | 4.0  |      |      | kV   | AC, 50 Hz, 1 min                |
| CTI                | Comparative Tracking Index | 600  |      |      |      |                                 |
|                    | Clearance Distance         | 12.5 |      |      | mm   | From 2 to 3, Note 4             |
|                    |                            | 11.5 |      |      |      | From 1 to Baseplate, Note 4     |
|                    |                            | 5.7  |      |      |      | From 2 to 5, Note 4             |
|                    |                            | 13.7 |      |      |      | From 5 to Baseplate, Note 4     |
|                    | Creepage Distance          | 14.7 |      |      |      | From 2 to 3, Note 4             |
|                    |                            | 14.0 |      |      |      | From 1 to Baseplate, Note 4     |
|                    |                            | 14.7 |      |      |      | From 2 to 5, Note 4             |
|                    |                            | 14.3 |      |      |      | From 5 to Baseplate, Note 4     |

Note 3 Total Effective Resistance (Per Switch Position) = MOSFET R<sub>DS(on)</sub> + Switch Position Package Resistance.

Note 4 Numbers reference the connections from the Schematic and Package Dimensions sections of this document.

**Typical Performance**

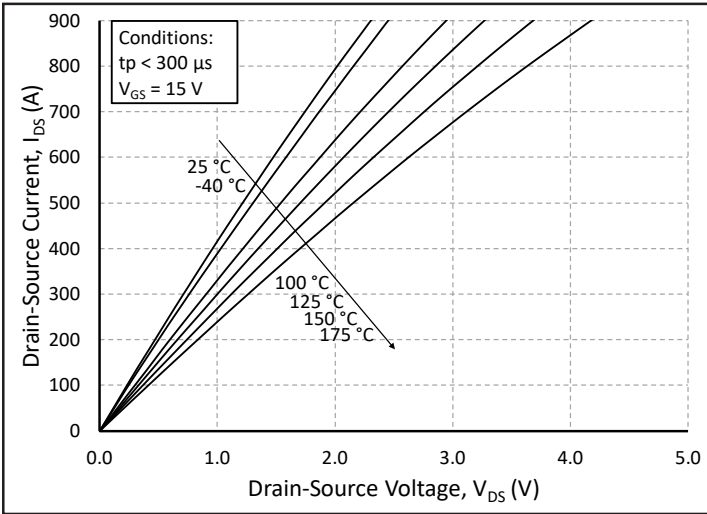

Figure 1. Output Characteristics for Various Junction Temperatures

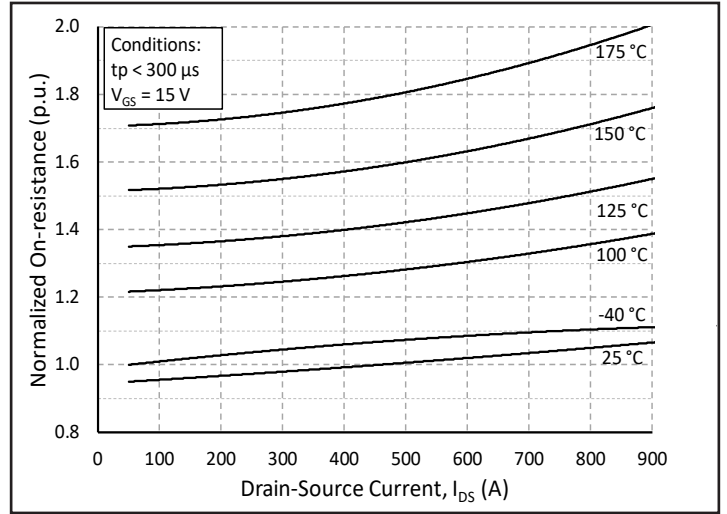

Figure 2. Normalized On-State Resistance vs. Drain Current for Various Junction Temperatures

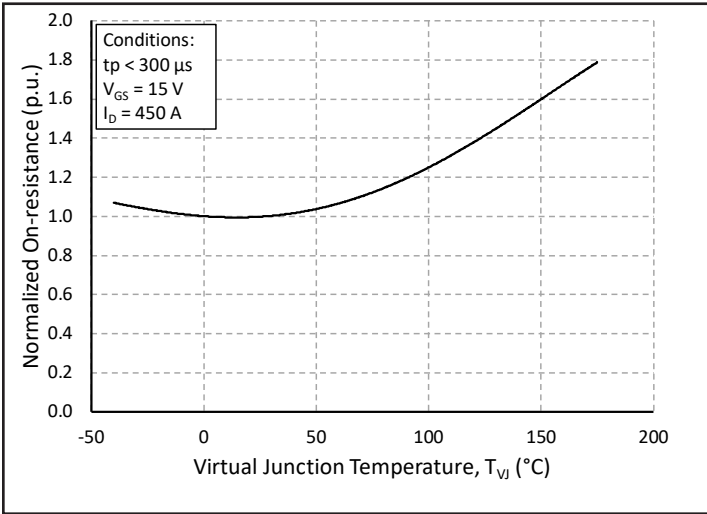

Figure 3. Normalized On-State Resistance vs. Junction Temperature

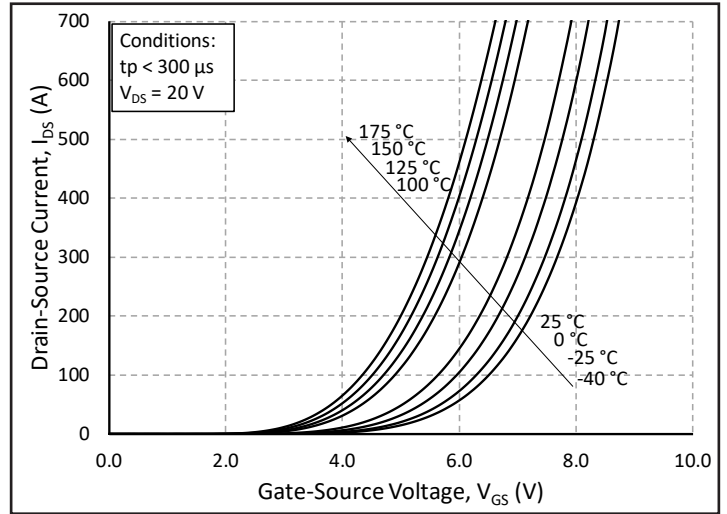

Figure 4. Transfer Characteristic for Various Junction Temperatures

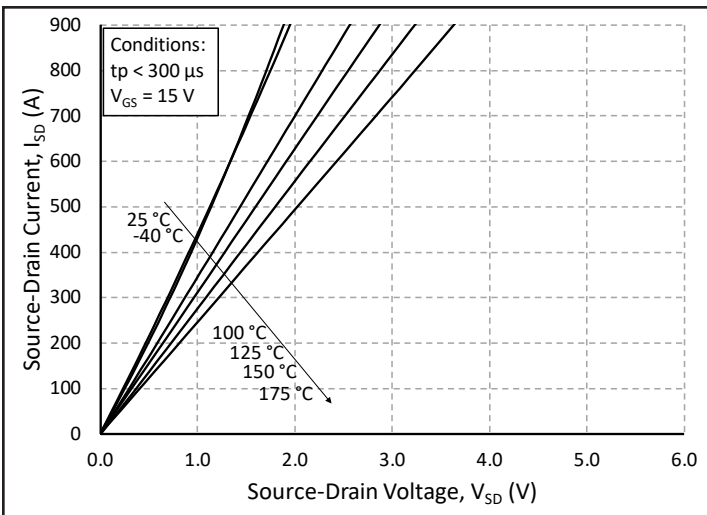

Figure 5. 3<sup>rd</sup> Quadrant Characteristic vs. Junction Temperatures at  $V_{GS} = 15$  V

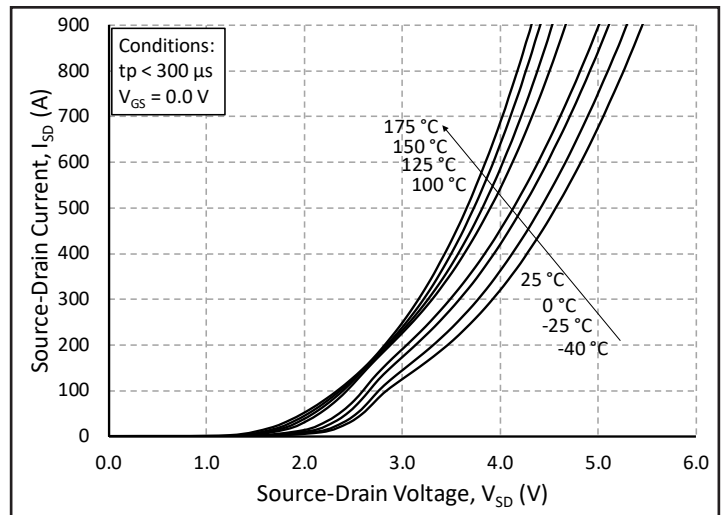

Figure 6. 3<sup>rd</sup> Quadrant Characteristic vs. Junction Temperatures at  $V_{GS} = 0$  V (Body Diode)

**Typical Performance**

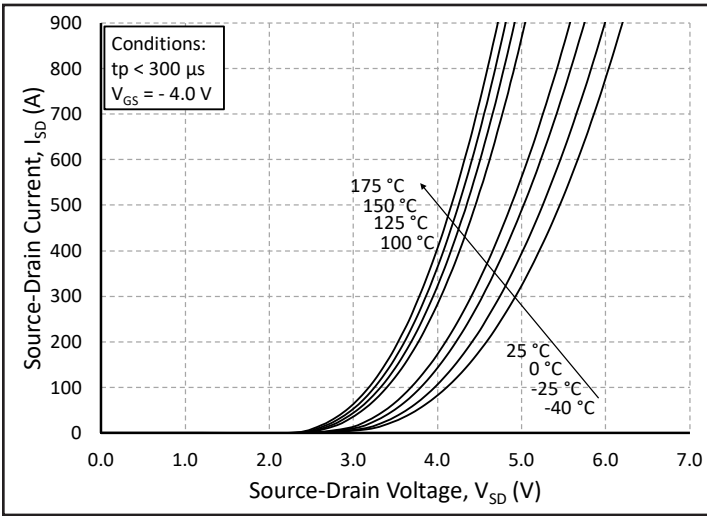

Figure 7. 3<sup>rd</sup> Quadrant Characteristic vs. Junction Temperatures at  $V_{GS} = -4\text{ V}$  (Body Diode)

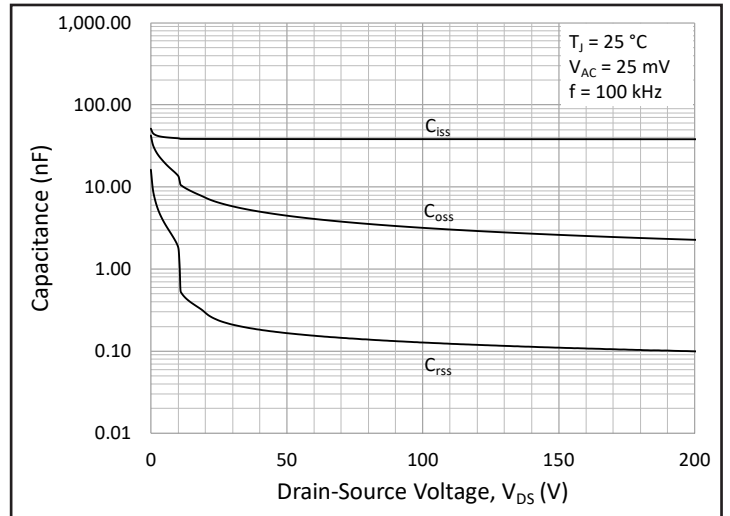

Figure 8. Typical Capacitances vs. Drain to Source Voltage (0 - 200V)

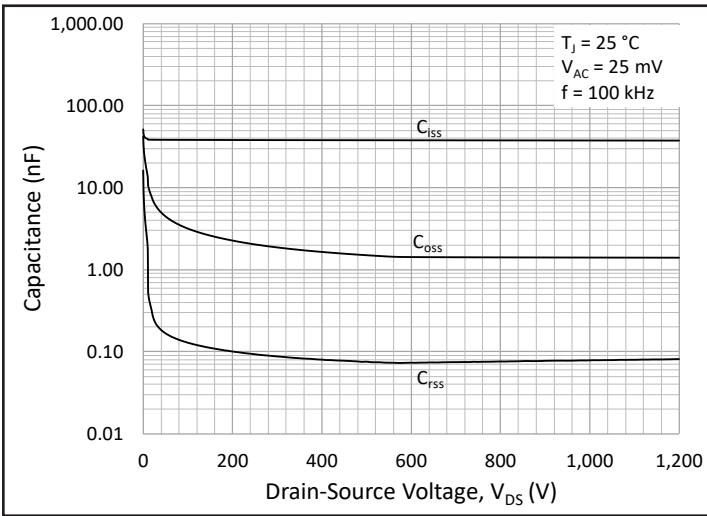

Figure 9. Typical Capacitances vs. Drain to Source Voltage (0 - 1200V)

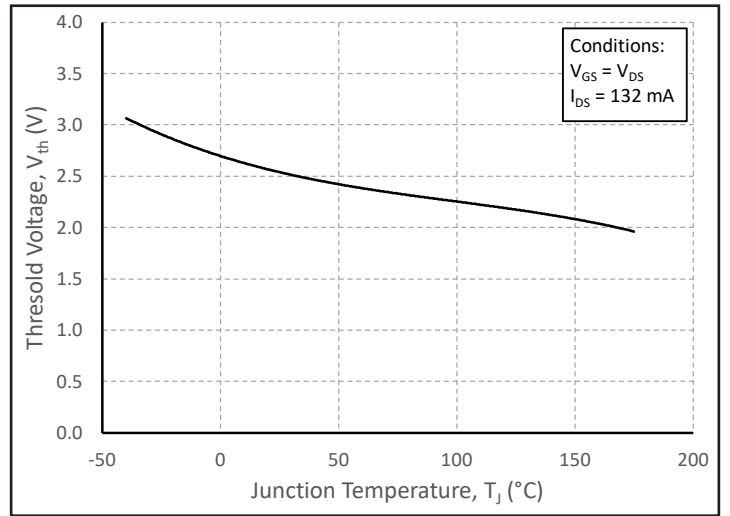

Figure 10. Threshold Voltage vs. Junction Temperature

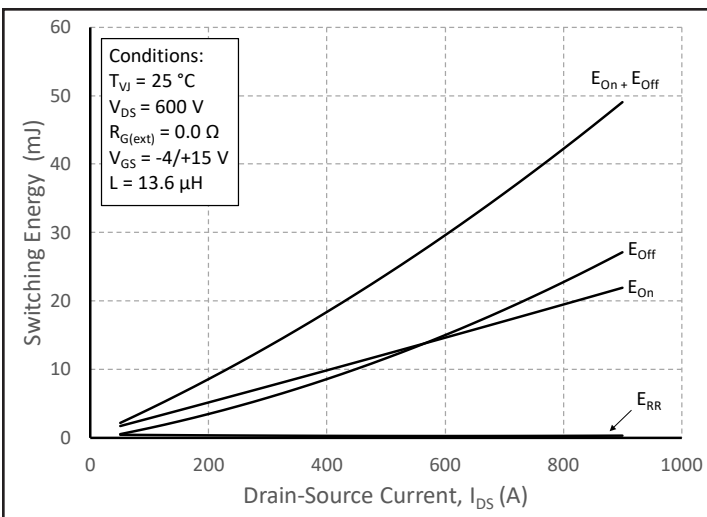

Figure 11. Switching Energy vs. Drain Current ( $V_{DS} = 600\text{ V}$ )

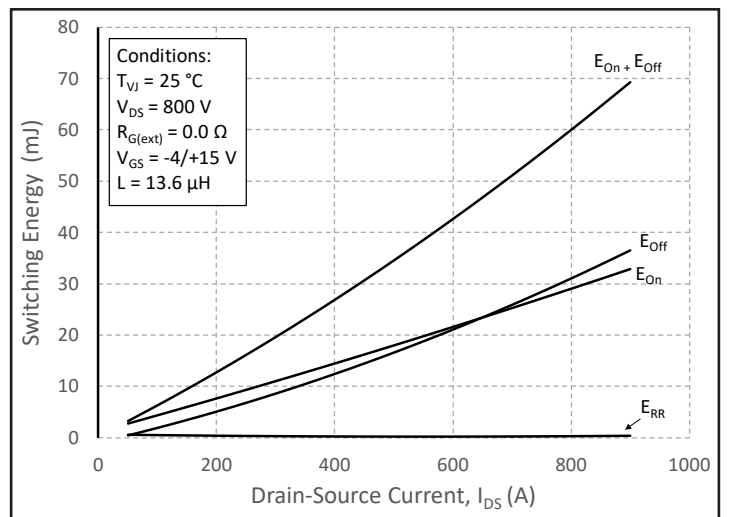

Figure 12. Switching Energy vs. Drain Current ( $V_{DS} = 800\text{ V}$ )

**Typical Performance**

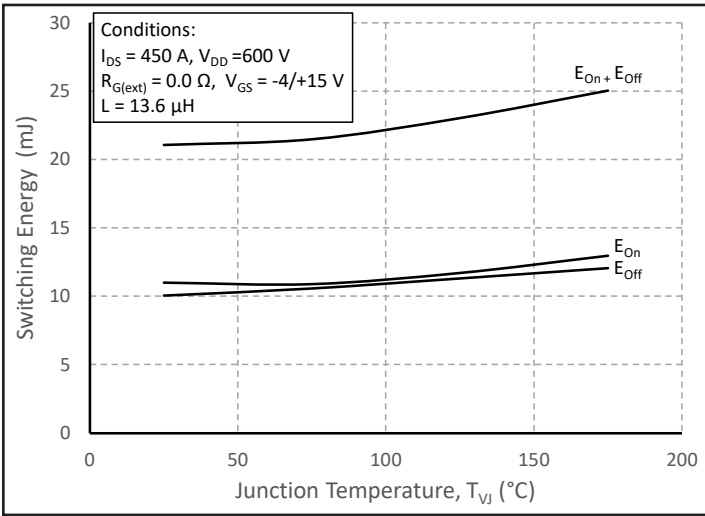

Figure 13. MOSFET Switching Energy vs. Junction Temperature

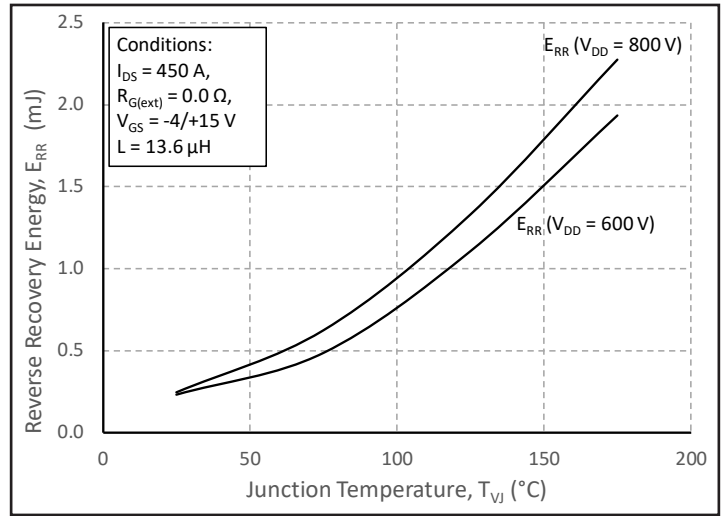

Figure 14. Reverse Recovery Energy vs. Junction Temperature

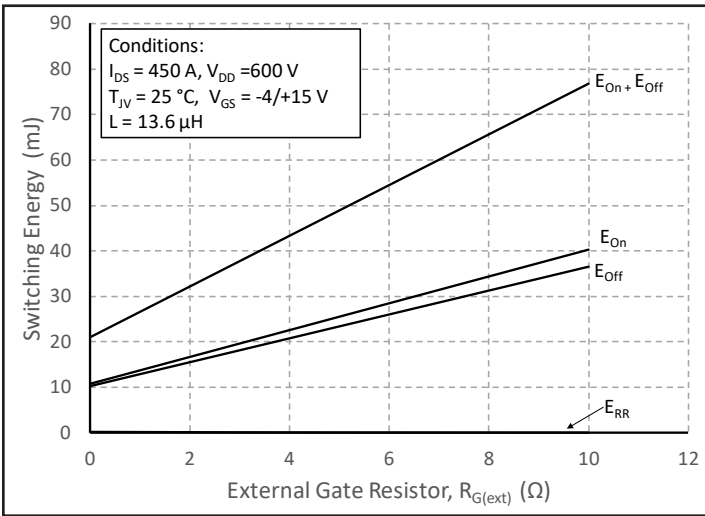

Figure 15. MOSFET Switching Energy vs. External Gate Resistance

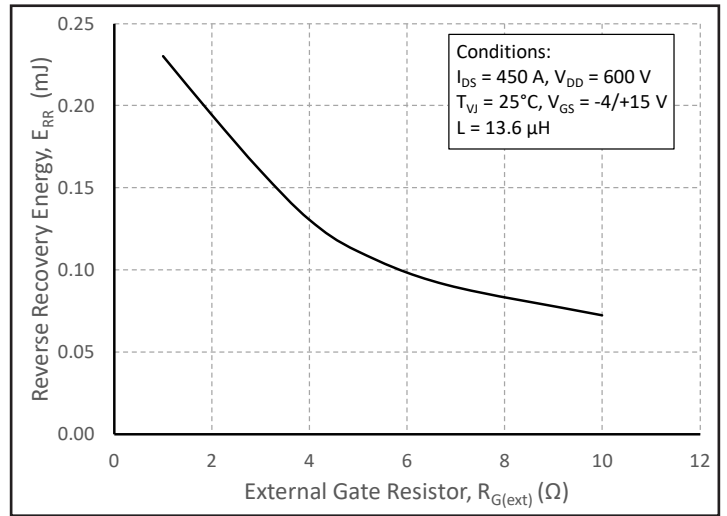

Figure 16. Reverse Recovery Energy vs. External Gate Resistance

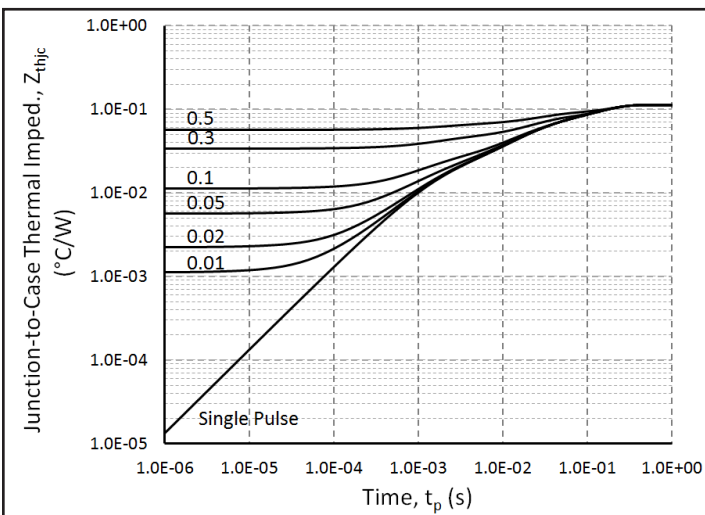

Figure 17. MOSFET Junction to Case Transient Thermal Impedance,  $Z_{thJC}$  (°C/W)

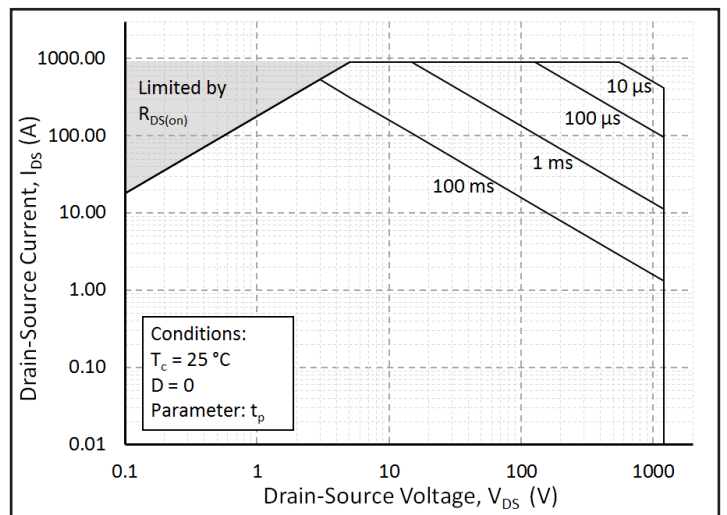

Figure 18. Forward Bias Safe Operating Area (FBSOA)

**Typical Performance**

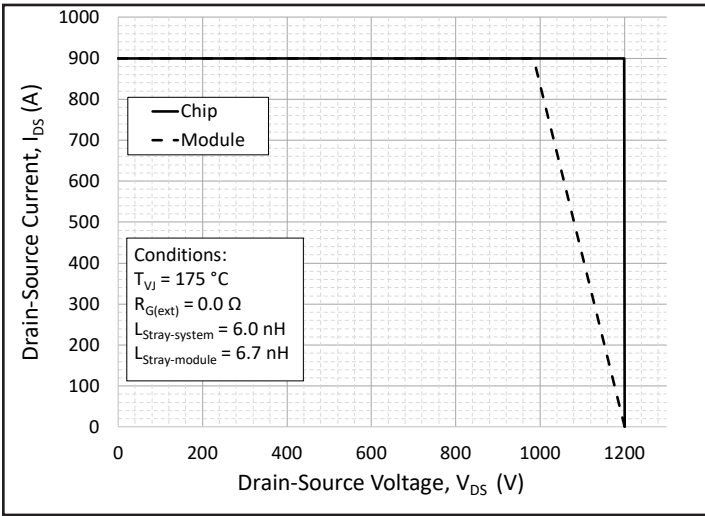

Figure 19. Reverse Bias Safe Operating Area (RBSOA)

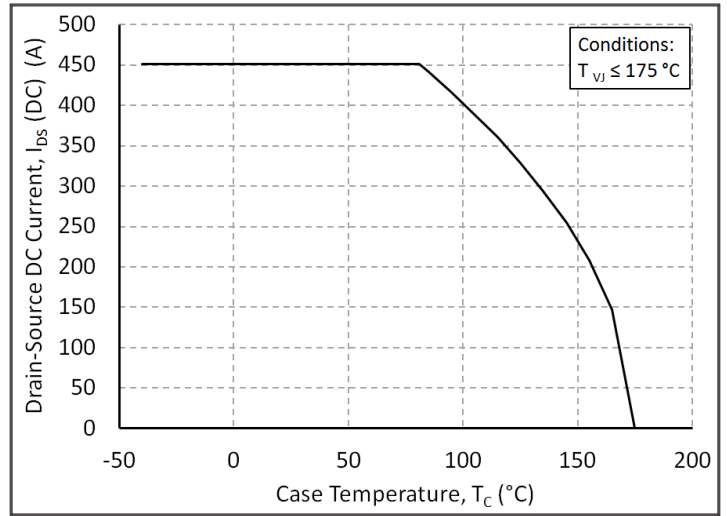

Figure 20. Continuous Drain Current Derating vs. Case Temperature

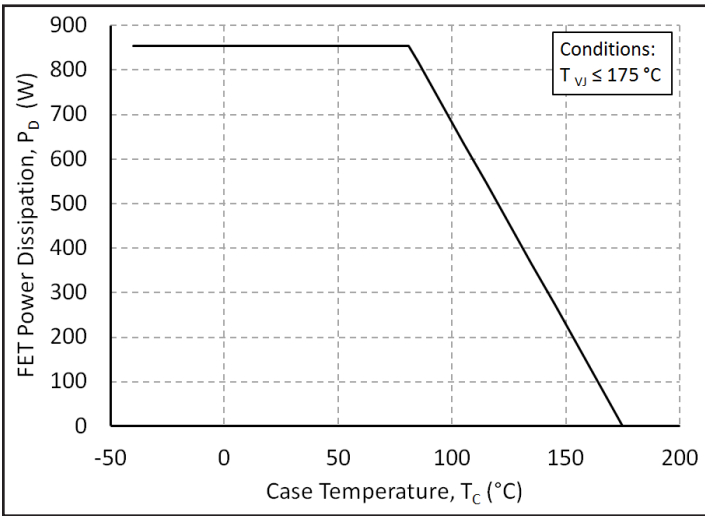

Figure 21. Maximum Power Dissipation Derating vs. Case Temperature

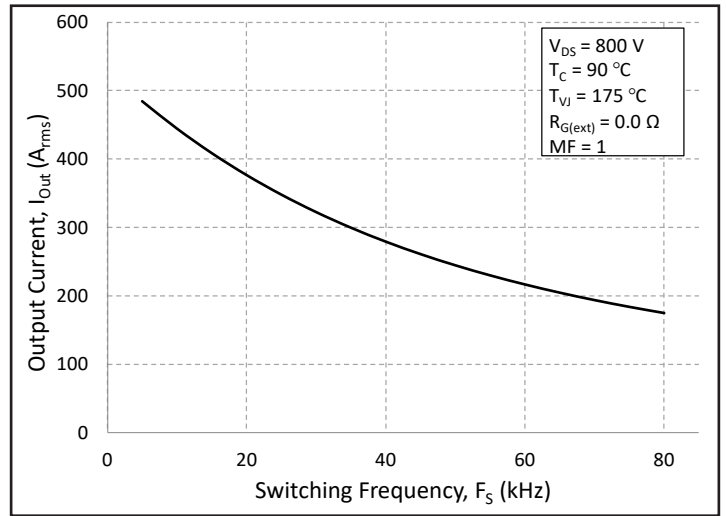
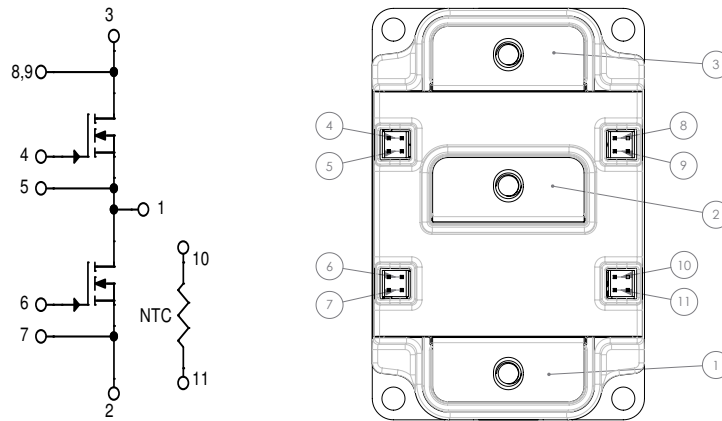

Figure 22. Typical Output Current Capability vs. Switching Frequency (Inverter Application)



## Schematic and Pin Out



## Package Dimension (mm)

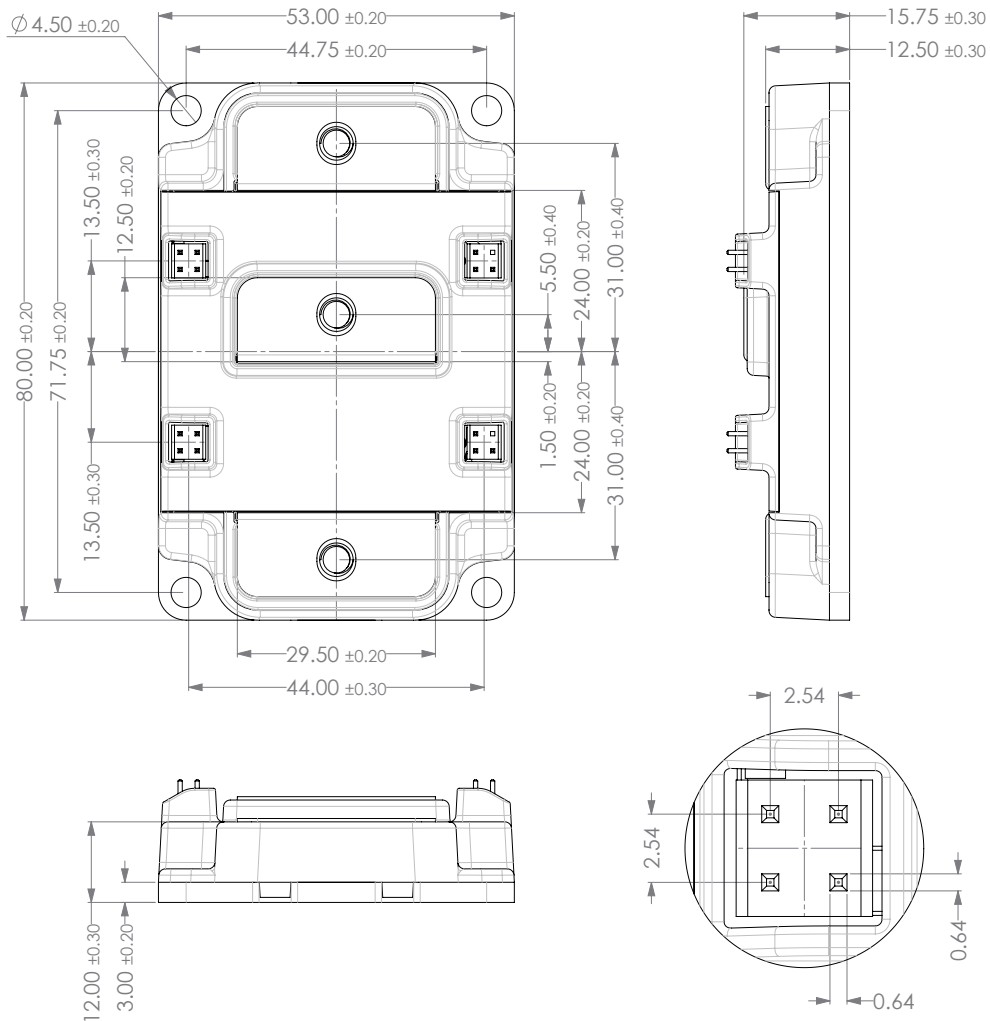



**Package Dimension (mm)**

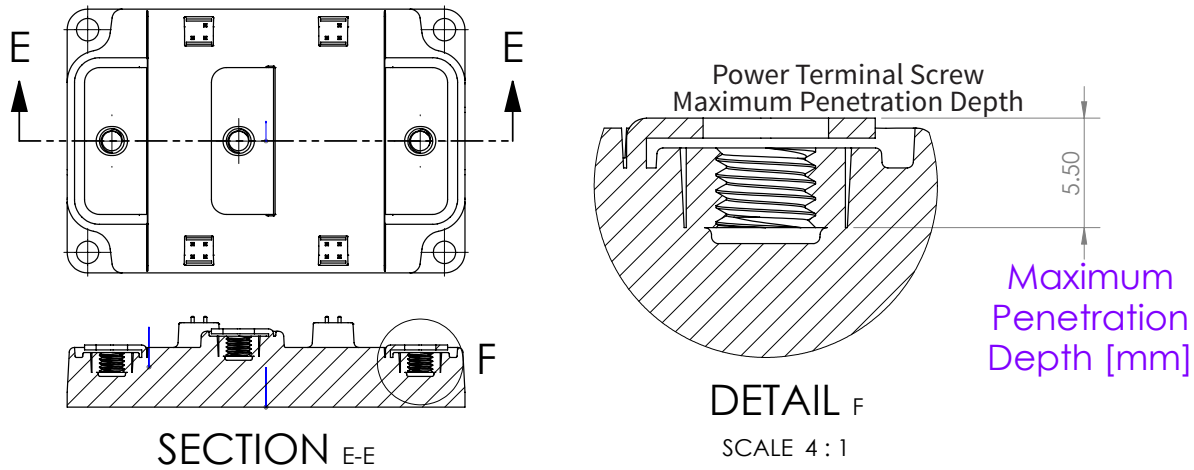

**Supporting Links & Tools**

- [CGD12HBXMP: XM3 Evaluation Gate Driver](#)
- [CGD12HB00D: Differential Transceiver Board for CGD12HBXMP](#)
- [CRD300DA12E-XM3: 300 kW Inverter Kit for Conduction-Optimized XM3 \(CPWR-AN30\)](#)
- [KIT-CRD-CIL12N-XM3: Dynamic Performance Evaluation Board for the XM3 Module \(CPWR-AN31\)](#)
- [CPWR-AN28: Module Mounting Application Note](#)
- [CPWR-AN29: Thermal Interface Material Application Note](#)

**Notes**

- This product has not been designed or tested for use in, and is not intended for use in, applications implanted into the human body nor in applications in which failure of the product could lead to death, personal injury or property damage, including but not limited to equipment used in the operation of nuclear facilities, life-support machines, cardiac defibrillators or similar emergency medical equipment, aircraft navigation or communication or control systems, or air traffic control systems.
- The SiC MOSFET module switches at speeds beyond what is customarily associated with IGBT-based modules. Therefore, special precautions are required to realize optimal performance. The interconnection between the gate driver and module housing needs to be as short as possible. This will afford optimal switching time and avoid the potential for device oscillation. Also, great care is required to insure minimum inductance between the module and DC link capacitors to avoid excessive VDS overshoot.

