

Flexible Motion Controllers **FQM1** Series

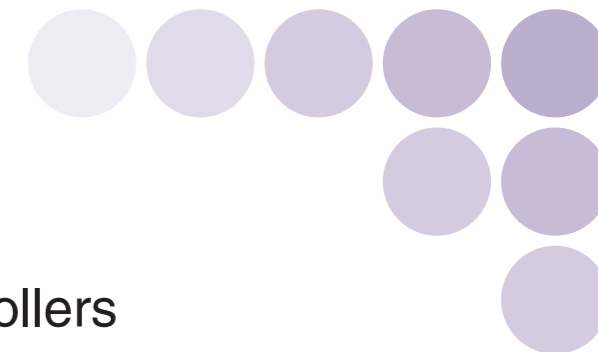

A New Concept in Motion Controllers
for Ideal Machine Operation



OMRON Corporation

Industrial Automation Company
Control Devices Division H.Q.
Motion Control Department
Shiokoji Horikawa, Shimogyo-ku,
Kyoto, 600-8530 Japan
Tel: (81) 75-344-7173/Fax: (81) 75-344-7149
2-2-1 Nishikusatsu, Kusatsu-shi,
Shiga, 525-0035 Japan
Tel: (81) 77-565-5223/Fax: (81) 77-565-5568

Regional Headquarters

OMRON EUROPE B.V.
Wegalaan 67-69-2132 JD Hoofddorp
The Netherlands
Tel: (31)2356-81-300/Fax: (31)2356-81-388

OMRON Industrial Automation Global: www.ia.omron.com

OMRON ELECTRONICS LLC

One Commerce Drive Schaumburg,
IL 60173-5302 U.S.A.
Tel: (1) 847-843-7900/Fax: (1) 847-843-7787

OMRON ASIA PACIFIC PTE. LTD.

No. 438A Alexandra Road # 05-05/08 (Lobby 2),
Alexandra Technopark, Singapore 119967
Tel: (65) 6835-3011/Fax: (65) 6835-2711

OMRON (CHINA) CO., LTD.

Room 2211, Bank of China Tower,
200 Yin Cheng Zhong Road,
PuDong New Area, Shanghai, 200120, China
Tel: (86) 21-5037-2222/Fax: (86) 21-5037-2200

Authorized Distributor:

© OMRON Corporation 2008 All Rights Reserved.
In the interest of product improvement,
specifications are subject to change without notice.

Cat. No. O901-E1-03

Printed in Japan
0808-1

realizing



Advanced Power in Three Applications: Motion Control, Measurement Control, and High-speed Response Control

FQM (Flexible Quick Motion)[®]

Flexibility, quickness, and a wide range of advanced motion operations enable the FQM1 to easily handle applications in the following three control areas.

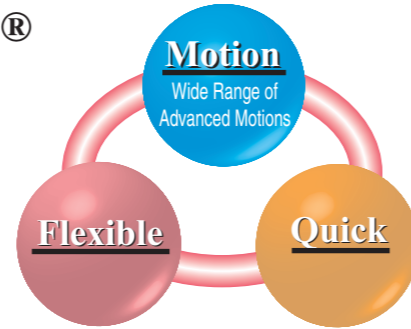

1. Motion control

2. Measurement control

3. High-speed response control

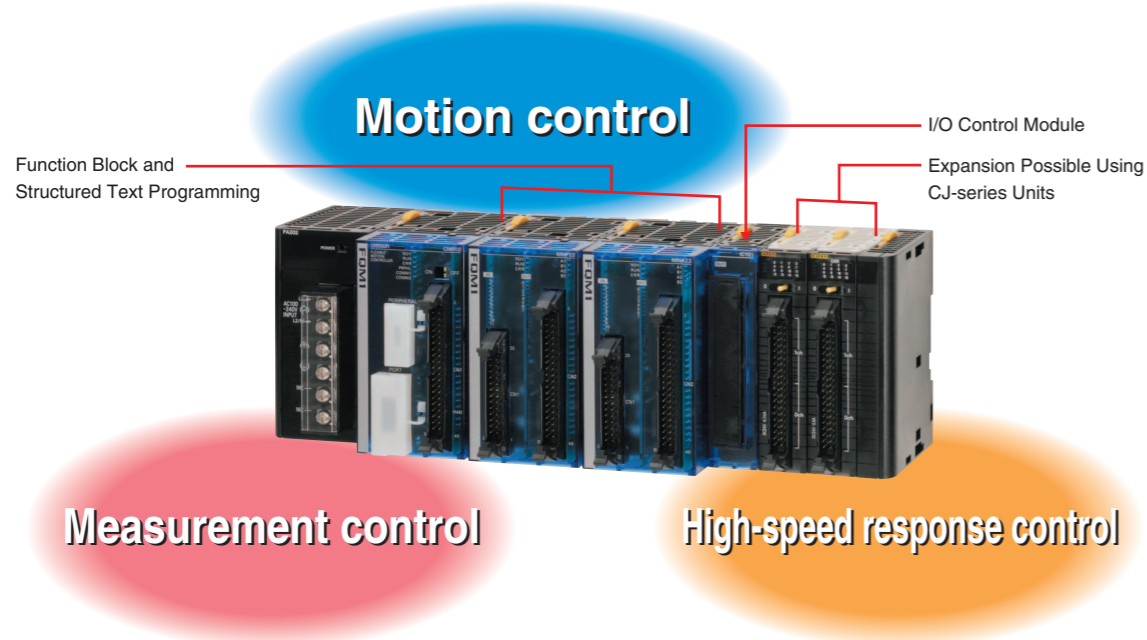

For the Non-stop Control

Ideal for Applications Performing Processing **without Stopping Machinery Operation**

To improve machinery performance, it is important to increase productivity by eliminating waste. Here, the FQM1 really performs to enable processing must be achieved without stopping machinery operation.

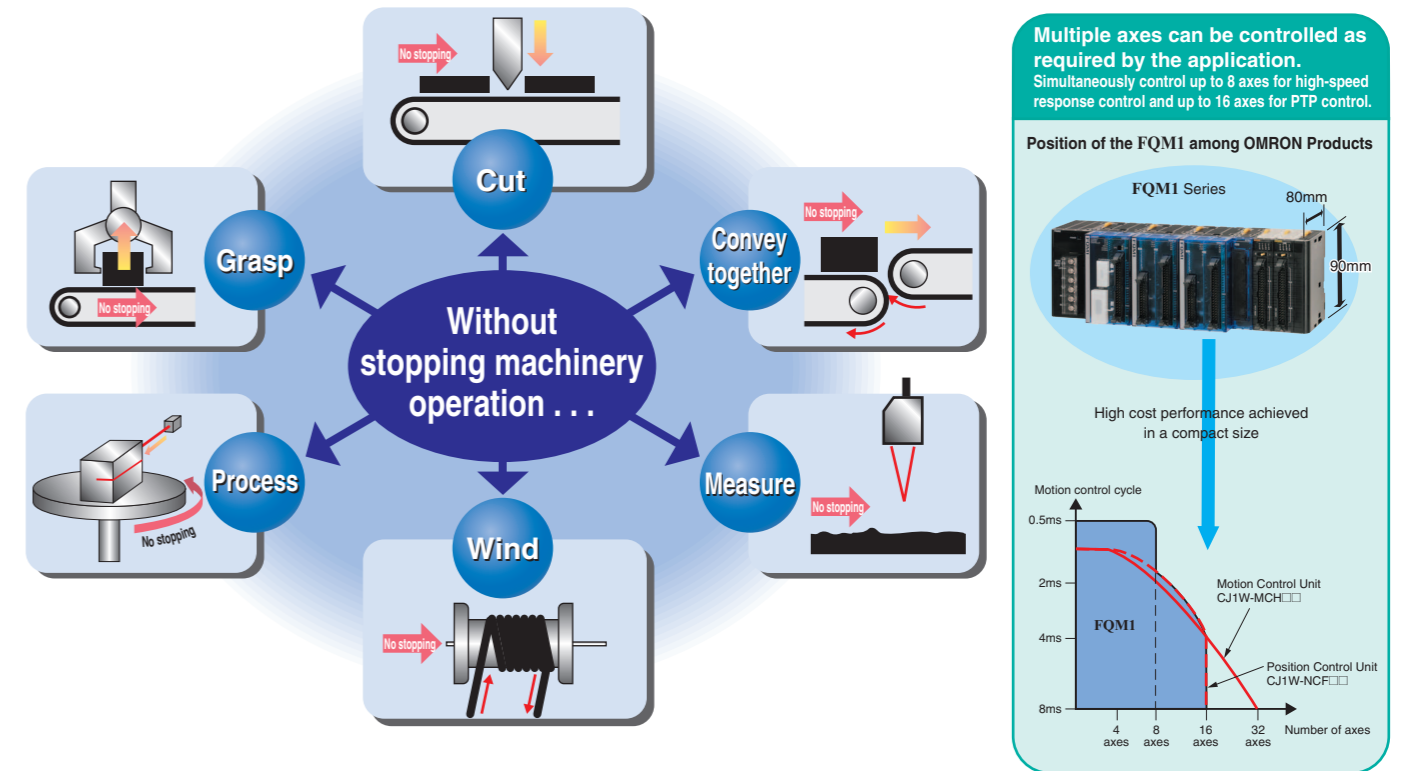

Compatible with NEW Servo and CJ-series Analog Units (Unit version Ver.3.3 or higher)

The FQM1 has become compatible with NEW AC Servo Motors/Drivers OMNUC G-series and SMARTSTEP 2-series, in addition to the conventional OMNUC W-series. Also, new analog units are included in CJ-series Units to be used for FQM1 expansion.

Compatible with NEW AC Servo Motors/Drivers OMNUC G-series



The FQM1 corresponds with the absolute value encoder interface of the special and high performance OMNUC G-series.

Compatible with Various CJ-series Analog Units



In addition to conventional high-speed type Analog Input Units (CJ1W-ADG41), Analog Input Units (8/4 points), Analog output Units (8/4/2 points), and Analog I/O Units (AD 4/DA 2 points) can be used.

Connecting the FQM1 with SYSMAC SPU Units enables simplification of the changes in various control and/or operation conditions as well as high speed collection of large capacity data.

Using SYSMAC SPU Units makes time reduction for tooling change for each operation possible. Replacing memory cards also allows for easy change of operations and/or conditions. During an inspection process, not only conditional changes but also inspection results can be saved securely.

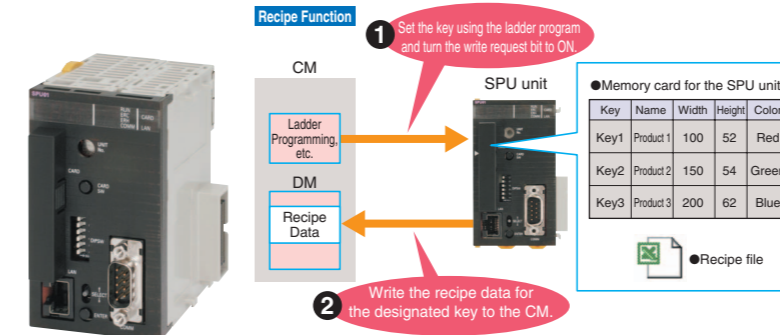

- Up to 65 (including the one basic collection pattern and data collection patterns from 1 to 64) data patterns can be collected in the data collection mode. Various data collection is possible if combining events.
- The setting information of SYSMAC SPU Units can be exported as an Excel file. The file can be used as a sheet to define and manage information on a device.

- The recipe function is used to write numeric values including operation parameters and/or character string data at one time to the CM (Controller Module) memory area. The recipe write function makes tooling change of the device easy. (Note: The recipe function can be used only in the "data collection mode".) * Create numeric values and character string data to be written to the CM memory area in recipe data (CSV file) and stored beforehand in a SYSMAC SPU Unit memory card.
- No ladder program is required to develop recipe data.
- The recipe function can save the CM memory because recipe data is saved in the memory card of a SYSMAC SPU Unit, which eliminates the need to save it in the CM data memory.
- Recipe data can be written upon request from the CM or via external devices including a PC.
- Numeric values and character string data can be changed even when a SYSMAC SPU Unit is in operation.

A Variety of Applications Accomplished with Motion, Measurement, and High-speed Response

High-level Wide-ranging Motion Achieved from F (Flexibility) and Q (Quickness).

From High-speed PTP Control to Synchronous, Torque, and Tension Control

Pulse/analog I/O feedback gives the FQM1 power in high-speed I/O applications.

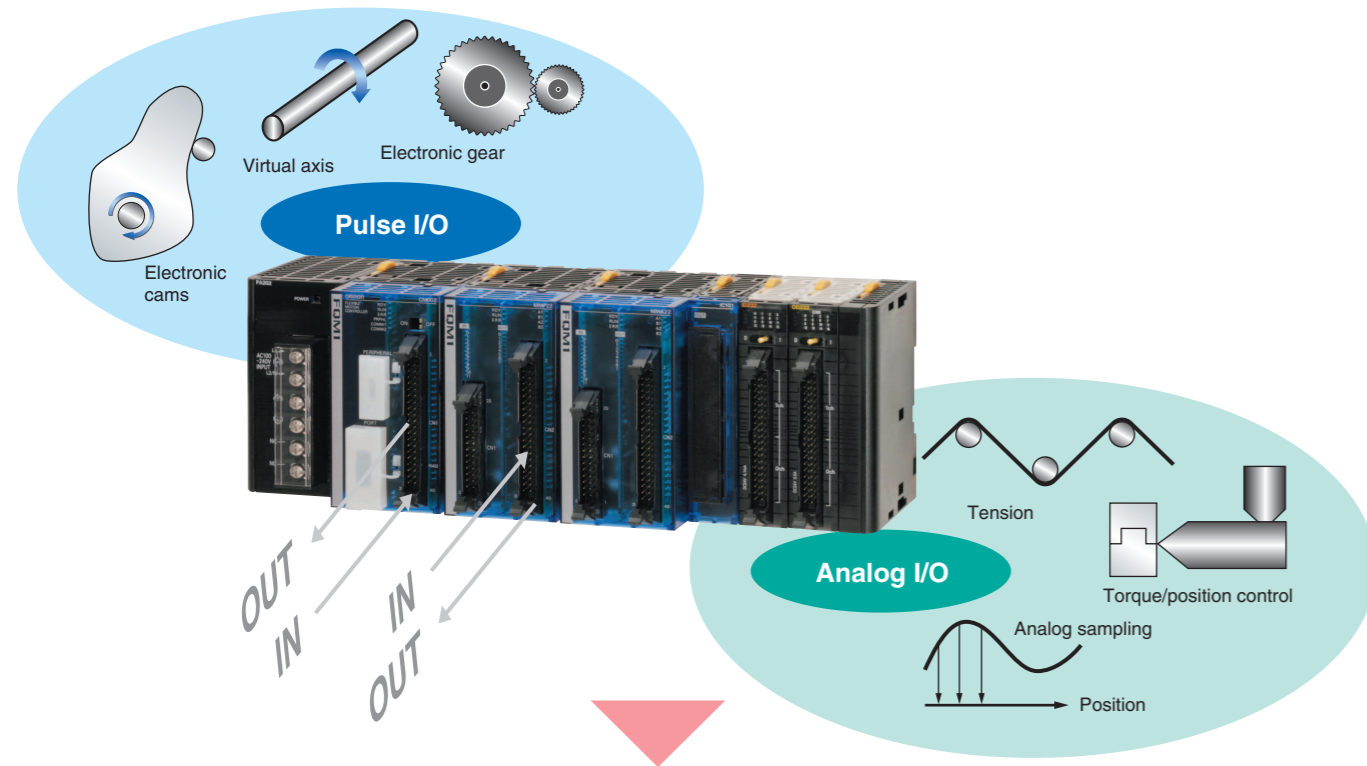

Wide-ranging FQM1 Applications

In addition to motion control, the FQM1 handles the following control areas through its ability to perform high-speed I/O processing through feedback from analog or pulse input data. Actual applications have already been implemented.

Control category		Application example	
Motion control	Synchronous control	Rotary cutters	Packaging machines
		Flying cutters	Traveling cutters
		Electronic cams	Processing line and lens processing
	Line control	Tension control	Winding and feeding
		Draw control	Paper feeding
	Torque control	Torque control	Injection molding
		Torque limit	Molding and pressing
Tracking control	CP control	Processing and coating	
	Traverse shaft	Winding	
Measurement control	Analog systems	High-speed analog sampling	Sheet thickness inspection and quality management
		High-speed PID control	Distance constant control
	Pulse systems	High-speed counters	Measurement (high-speed) and F/V conversion
High-speed response control	I/O control	Synchronous startup	Conveyers
		Interrupt feeding	Labeler
		High-speed PTP control	Conveyers
		High-speed counters	Conveyers

Motion Control Applications

The FQM1 Achieves High-precision Trailing Using High-speed Control Cycles **Cut** without stopping. **Grasp** without stopping. **Convey together** without stopping.

High-precision trailing with little fluctuation is possible due to the high-speed responsiveness of the FQM1. An instruction for line segment approximation can be used during operation to change the pattern of the curve.

Application Examples Non-stop processing, such as materials transfer, filling, and cutting

For example, marks on objects to be cut that are continually fed along a production line are detected and cutting is performed continually without stopping the line. The encoder on a measuring roll detects the feed amount supplied by a feed roll, and a cutter cuts with speed-synchronized trailing along the mark detected by a mark sensor. The workpiece is cut after synchronization. The origin is returned to after cutting is completed and the process is repeated.

- Functions used: Electronic cam (operated by executing the PULSE OUTPUT instruction to synchronize trailing of the slave axis based on the speed of the conveyor of the master axis)
- Configuration example: FQM1-CM002 plus FQM1-MMP22 (with pulse I/O)

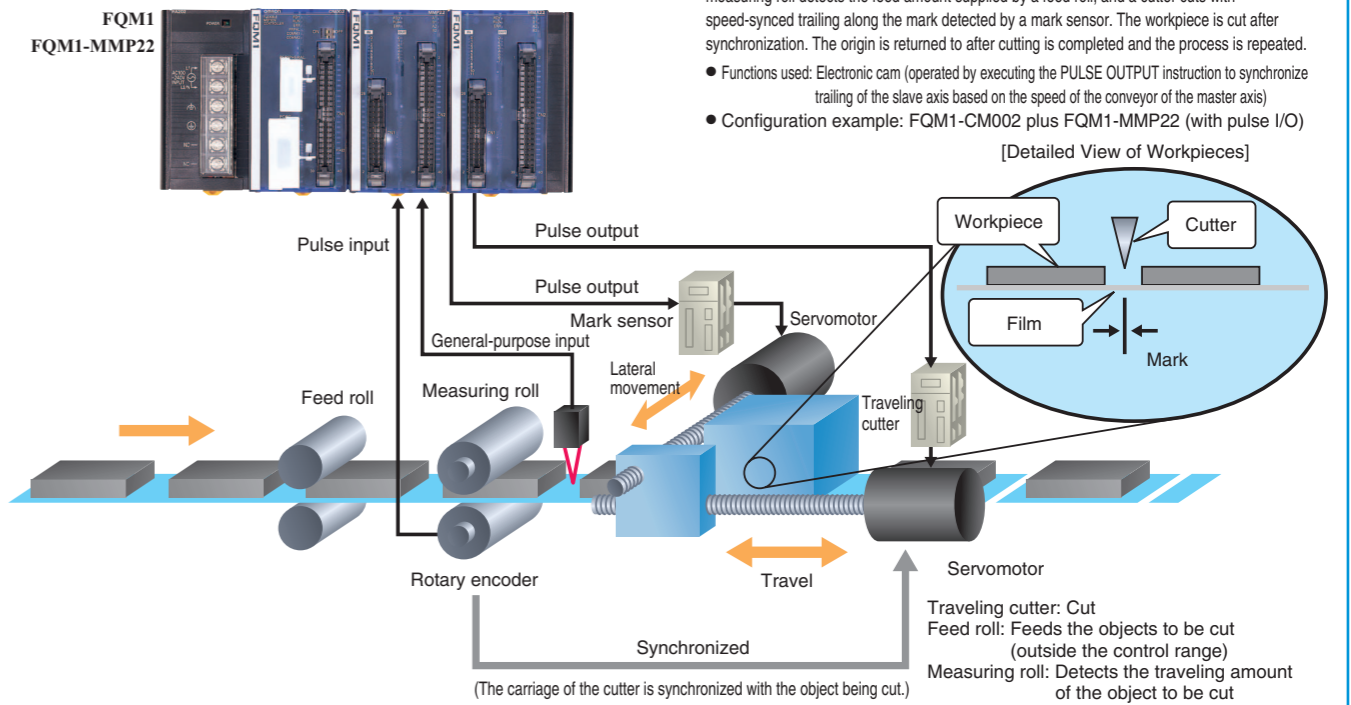

The high-speed cycle and processing method of the FQM1 enable flexible cam patterns. **Cut** without stopping.

The high-speed cycle and high level of processing functions enable synchronous control of electronic cams using either a cam table method or a data processing method.

In particular, when the data processing method is used, it is possible to realize a high-speed control cycle during processing, enabling the cam to be changed during operation.

When using the cam table method, tables can be linked and used even while switching cam tables, enabling high-resolution curves.

Application Examples • Operating the rotary cutter of a packaging machine or a food processing machine • Matching the timing between lines • Printing

For example, a sheet is fed continuously on a production line and cut to the specified dimension without stopping the line. The encoder on the measuring roll measures the length of the feed amount, which serves as the basis of the operation of the cutter. Cutting time (the blade intersection time) is synchronized to the line speed, and the cutter is accelerated or decelerated in the remaining time to cut to the preset dimension.

- Functions used: Electronic cam (operated by executing the PULSE OUTPUT instruction on the target position multiplied by the curve table formed by executing an instruction for line segment approximation for the position of the slave axis or by using data processing)

- Configuration example: FQM1-CM002 plus FQM1-MMP22 (with pulse I/O) plus FQM1-IC101 (I/O Control Module) plus CJ1W-SRM21 (CompoBus/S Master Unit)

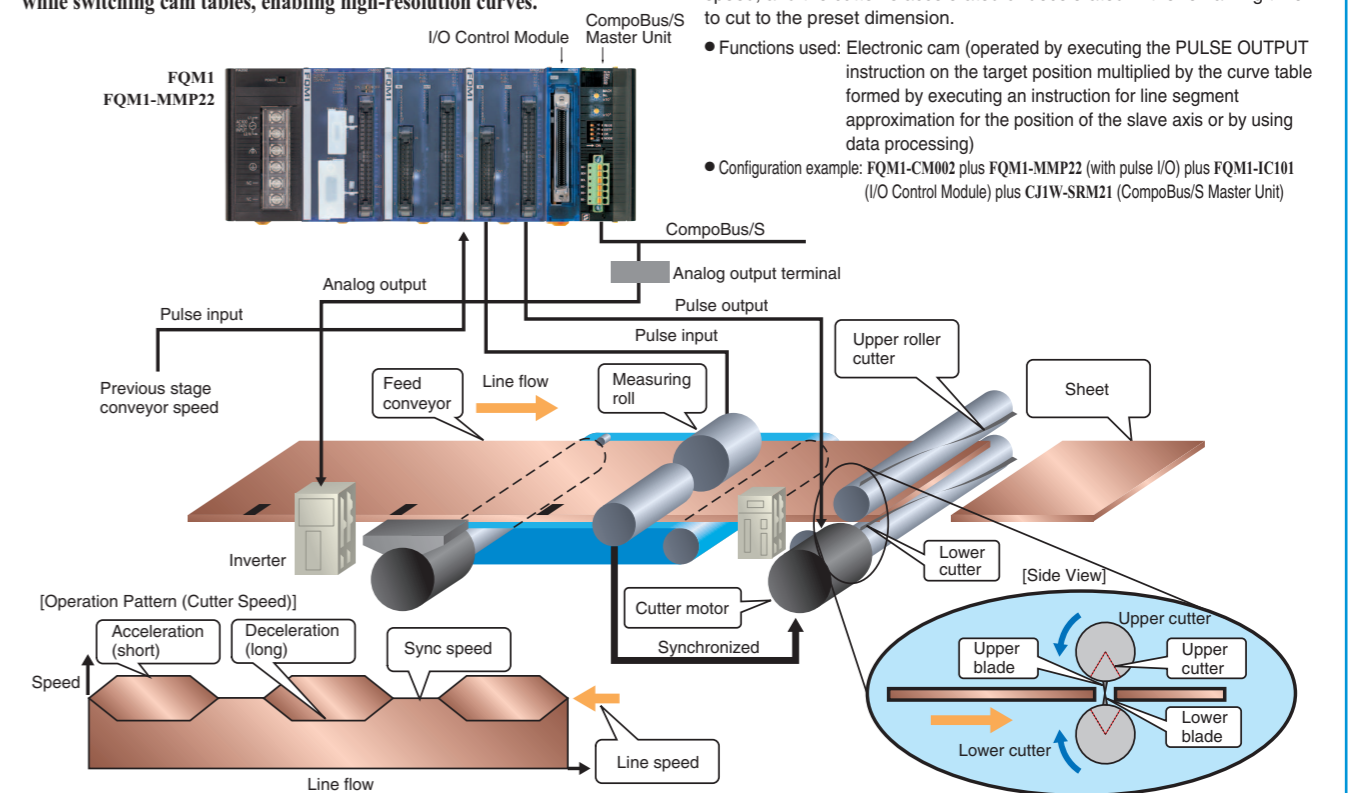

FQM1 High-speed Control Cycles and High Resolution Enable Free Speed Control Process without stopping.

The FQM1 high-speed control cycle enables various speed controls required in production equipment such as molding machines (injection speed, mold clamping/mold opening, screw turning speed, etc.) to be programmed in detail. In particular, highprecision control is achieved by incorporating feedback using analog input, servo drive SPEED commands, and analog output.

- Application Examples**
- Speed control for injection molding machine
 - Torque control for extruding and pressing
- For example, the amount of material pushed into the molding machine and the pressure are controlled. Position control (the output amount equals the number of rotations) and torque control (the pressing pressure equals the pressure) are performed during operation.
- Functions used: Switching from position control (SPEED command) to pressure control (SPEED command and torque limit) to Position Control SPEED command)
 - Configuration example: FQM1-CM002 plus FQM1-MMA22 (with analog I/O) plus FQM1-IC101 (I/O Control Module) plus CJ1W-NC71 (Position Control Unit with MECHATROLINK-II)

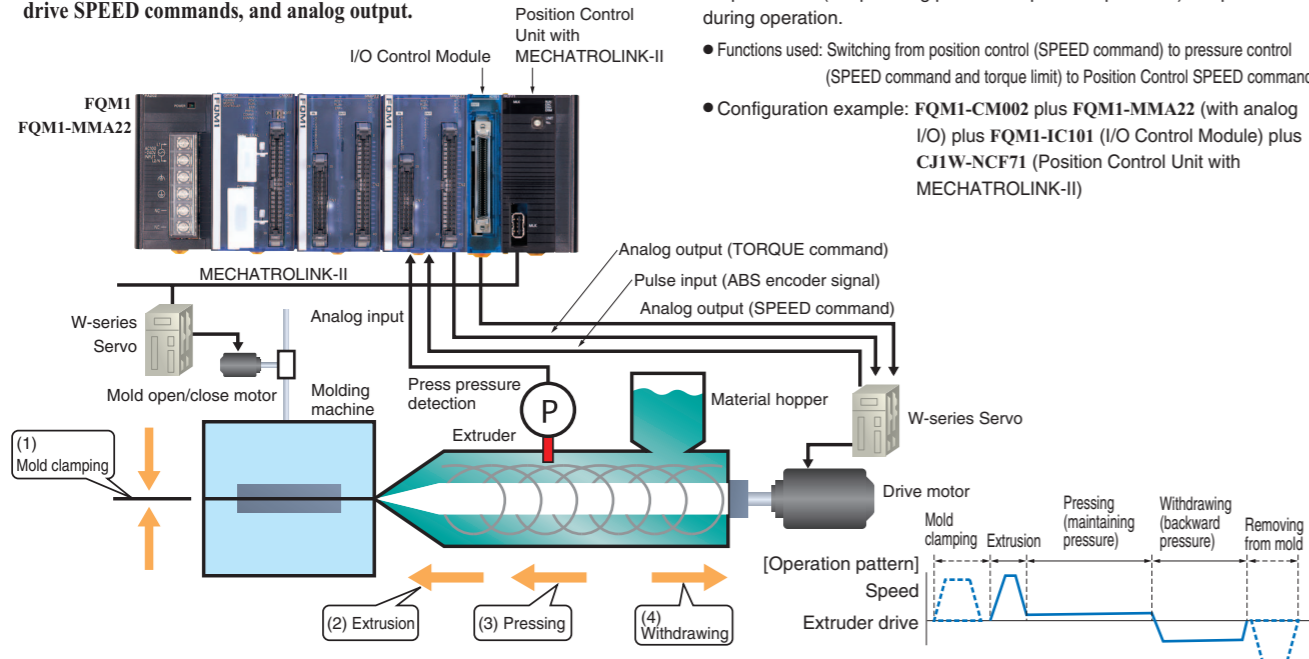

The FQM1 High-speed Control Cycle Enables High-precision Processing Process without stopping.

Applying synchronous control of the electronic cam, the FQM1 high-speed control cycle can be used to achieve minute tracking control during processing. The ability to execute position commands in a highspeed control cycle of 1 to 2 ms enables improved manufacturing accuracy even for complicated processes, such as elliptical tracking. Tracking control, such as linear interpolation, circular interpolation, and elliptical interpolation, can be performed by changing the target position.

- Application Examples** Gluing, welding, or grinding a design to a unique shape
- For example, taking the master axis as the base axis, two real axes are synchronized to the base axis, and then a tracking pattern is formed with an instruction for line segment approximation to set the target position.
- Functions used: Synchronous control of the electronic cam, linking of the line segment pattern using an instruction for line segment approximation
 - Configuration example: FQM1-CM002 plus FQM1-MMP22 (with pulse I/O)

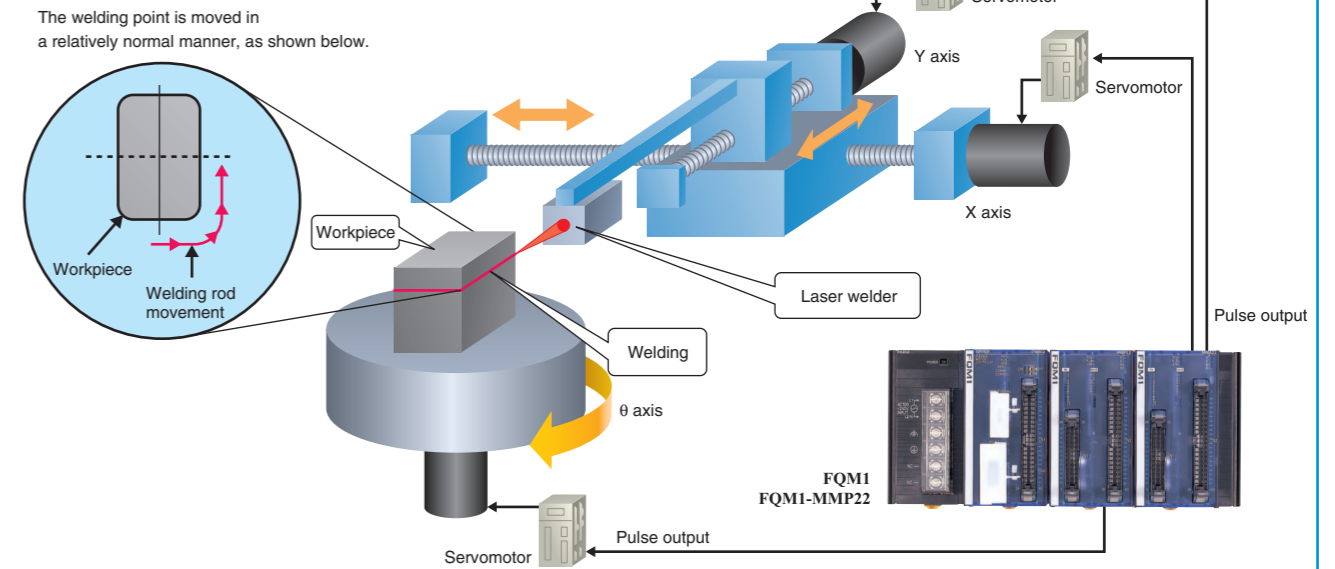

The FQM1 High-speed Feedback Loop Enables Stable Control Convey together without stopping.

High-speed analog I/O and a high-speed control cycle enable stable line control. A high-speed feedback loop for controlling the motor speed can be set up with the analog input data from the dancer roller or the tension detector. Also, the internal program can be flexibly combined for compensation processing.

- Application Examples** Winding, feeding control
- For example, the tautness can be controlled by adjusting the speed of the feeding axis and the winding axis while detecting the position of the dancer roller using an analog input.
- Functions used: Analog I/O, PI with ladder program, ratio calculations
 - Configuration example: FQM1-CM002 plus FQM1-MMA22 (with analog I/O) plus FQM1-MMA22 (with analog I/O)

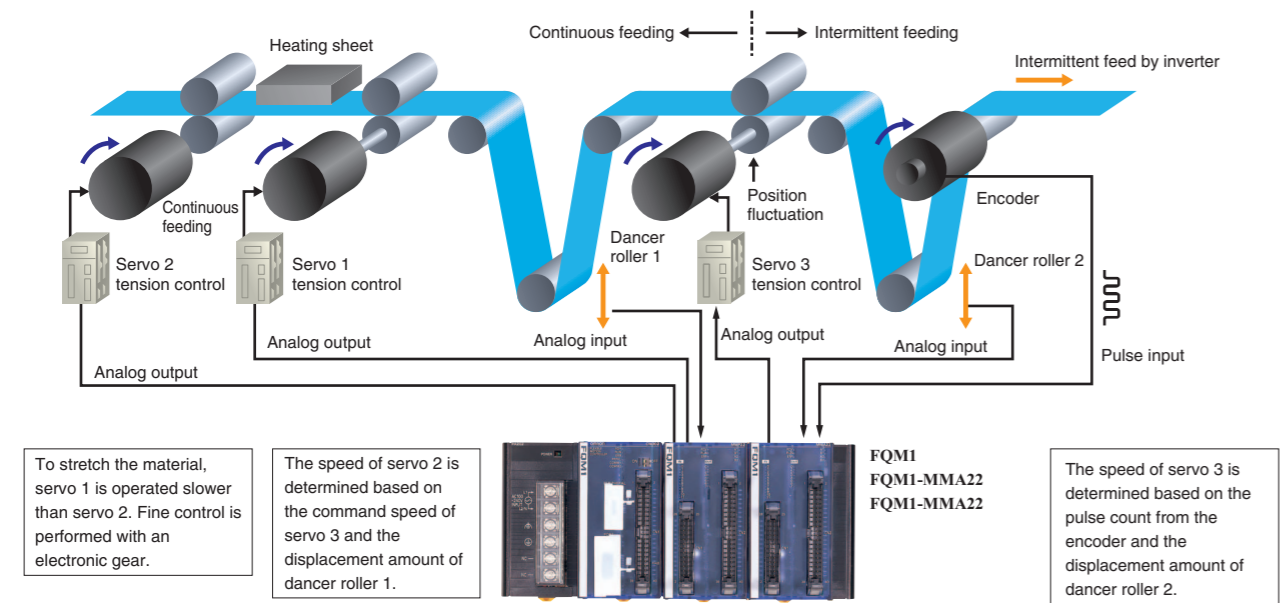

High-quality Winding Control with the FQM1's High-speed Control Cycle Wind without stopping.

High-speed pulse I/O and a high-speed control cycle are used to achieve high-quality winding control. An accurate winding pitch is achieved by controlling the relation between the spindle and the traverse amount using an electronic cam system and tracking the transverse motion to the gradually changing rotational amount of the spindle.

- Application Examples** Wire/Thread Winding Control
- For example, the transverse motion is controlled using an electronic cam system in response to spindle commands or rotation feedback.
- Functions used: Synchronous control of the electronic cam, switching of the linear pattern using an instruction for linear approximation
 - Configuration example: FQM1-CM002 plus FQM1-MMP22 (with pulse I/O)

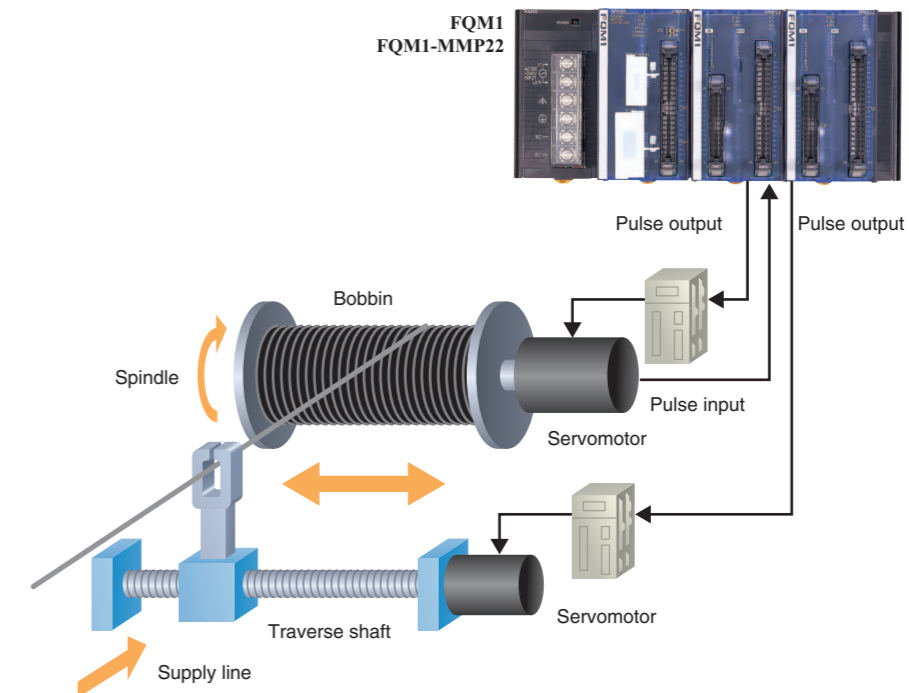

The High-speed Control Cycle and Processing Power of the FQM1 Expand the Range of Synchronous Control. Process without stopping.

A high-speed control cycle and high-performance processing power enable synchronous control of the electronic cam, thereby enabling processing without stopping the line.

Application Examples Label printing

For example, printing can be performed on items flowing along the line without stopping by rotating the printing drum synchronized with the line speed.

- Functions used: Synchronous control of the electronic cam, high-speed processing
- Configuration example: FQM1-CM002 plus FQM1-MMP22 (with pulse I/O)

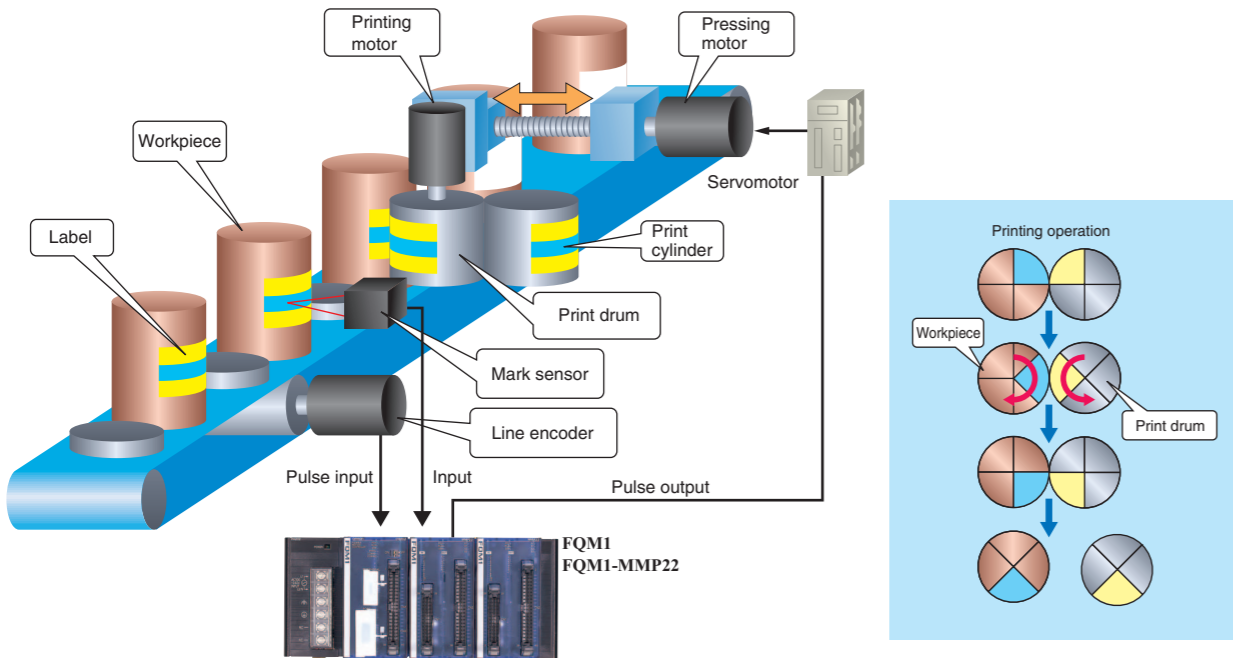

Use the FQM1 Synchronized Data Function to Enable Synchronized Compensation Control. Convey together without stopping.

With the FQM1, the data held by the Motion Control Modules can be shared by using a sync bus. Analog data shared in this way can be used as compensation for position control.

Application Examples Feed control for parallel conveyors

For example, while the base hoist axis synchronized to the table position is controlled with pulse input data by the FQM1-MMP22, analog input data, such as that from a displacement sensor, can be obtained via a sync bus from the FQM1-MMA22 and used to compensate the hoist axis control.

- Functions used: Sync data function
- Configuration example: FQM1-CM002 plus FQM1-MMA22 (with analog I/O) plus FQM1-MMP22 (with pulse I/O)

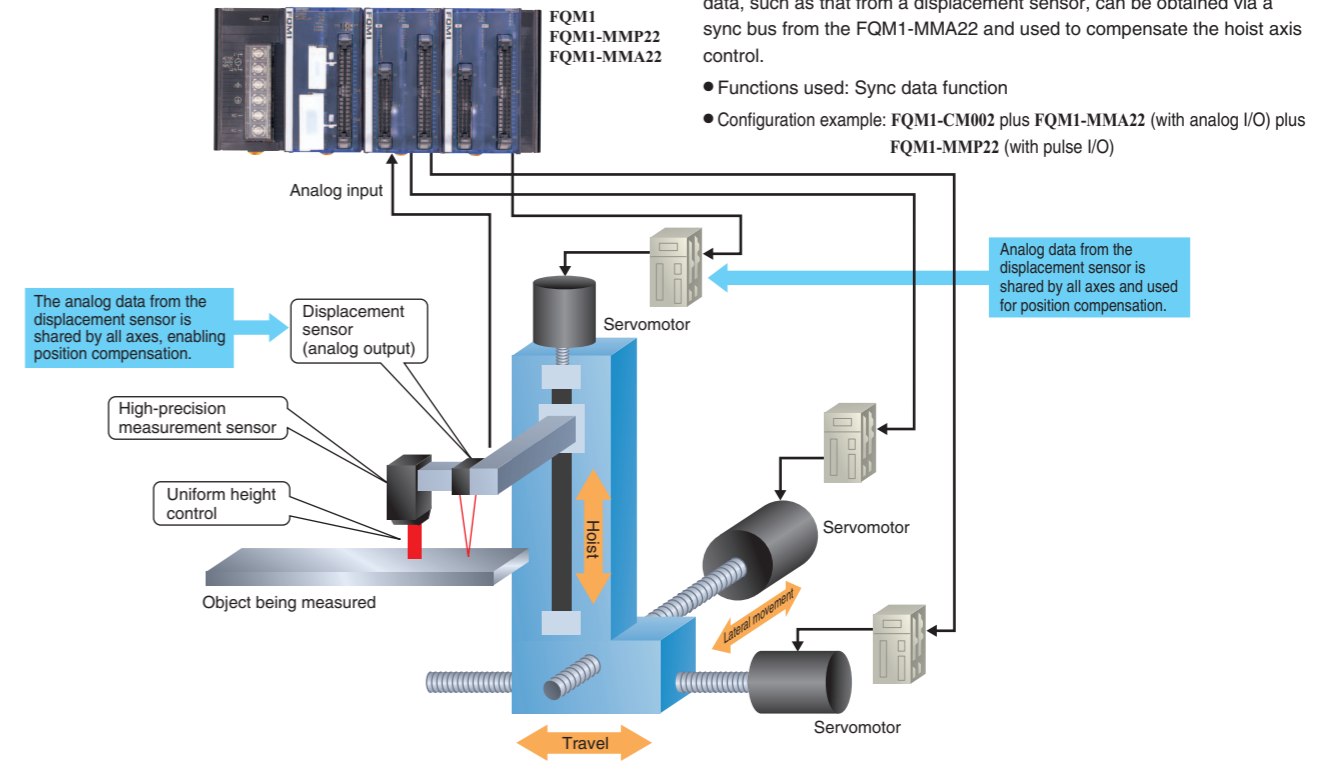

Measurement Control Applications

High-speed Analog Sampling Synced on an FQM1 Pulse Input Measure without stopping.

The FQM1-MMA22 has a high-speed sampling and storage function for analog input data that is synced with input pulses (i.e., the position of the target object). This achieves sampling performance beyond that achieved with conventional controllers, and also supports sampling in sync with an external signal, whereas only sampling over specified times was possible until now.

Application Examples Quality analysis by detecting warping or other conditions of minutely processed products

For example, by collecting multipoint displacement data over the course of changes in the position of the target object from one position to another, the warping or other conditions of minutely processed products can be detected and quality analyzed.

- Functions used: High-speed analog sampling
- Configuration example: FQM1-CM002 plus FQM1-MMA22 (with analog I/O)

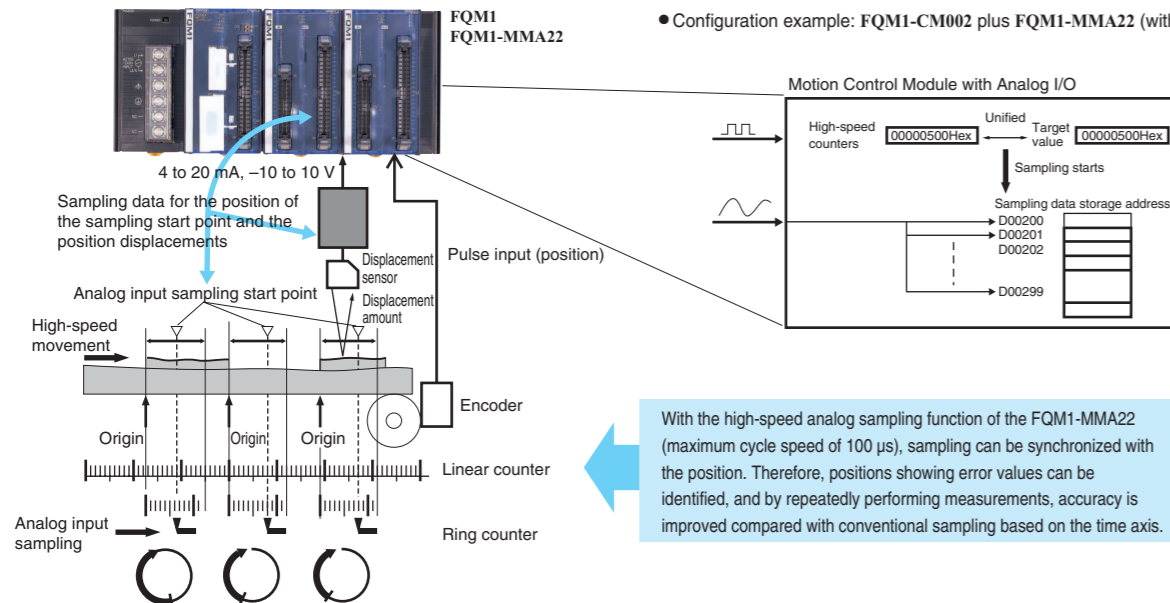

With the high-speed analog sampling function of the FQM1-MMA22 (maximum cycle speed of 100 μs), sampling can be synchronized with the position. Therefore, positions showing error values can be identified, and by repeatedly performing measurements, accuracy is improved compared with conventional sampling based on the time axis.

High-speed Response Control Applications

Flexible Speed Control with Freely Controlled Pulse Outputs

With the renewed FQM1, the freedom in speed control has been greatly increased by using pulse outputs. In the operation of infinite-axis feeding, the rotation speed can be changed by changing the frequency of the pulse output as desired based on the time axis.

Application Examples Speed Control for Infinite-axis Feeding

For example, the ideal rotational operation can be performed for the speed of a rotating body by changing the speed or acceleration/deceleration as desired over time.

- Functions used: ACC instruction (ACCELERATION CONTROL)
- Configuration example: FQM1-CM002 plus FQM1-MMP22 (with pulse I/O)

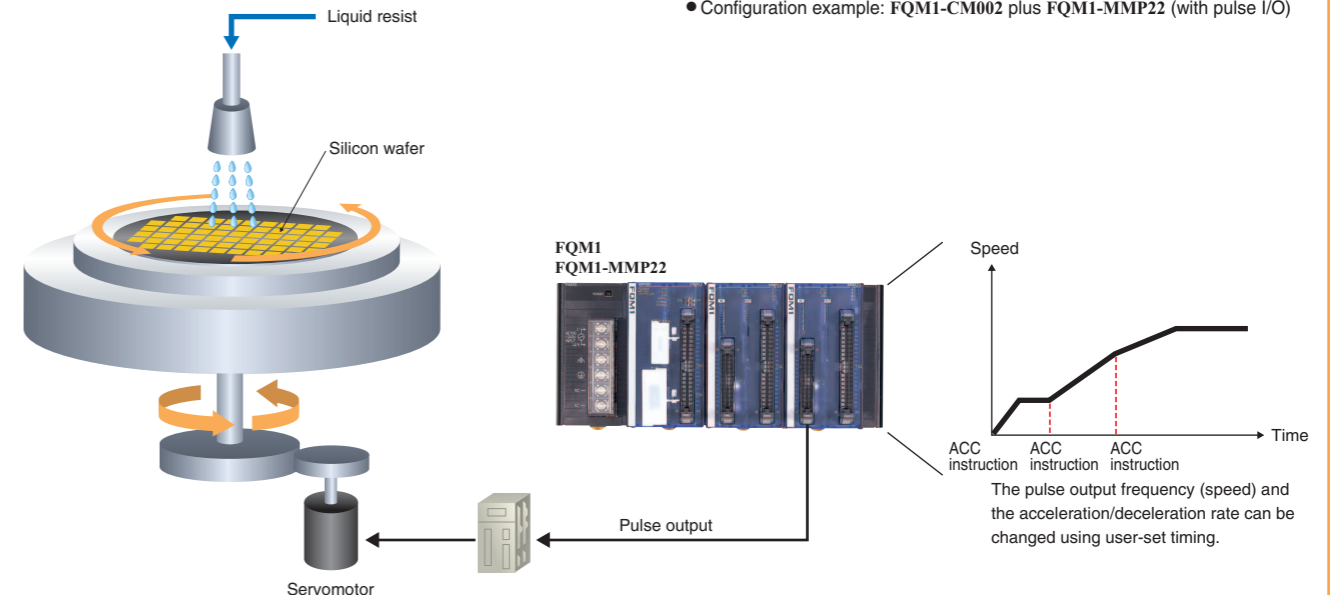

Pulse Output Control with the FMQ1's High-speed Input Response

Sensor inputs can be detected with high precision by using the FMQ1's dependable interrupt input response and the high-speed input latching function for pulse inputs. This improves precision when switching or stopping machine operation and performing processing from sensor inputs.

Application Examples **Labeler**

For example, the stop function can be performed with high-precision stop positioning at a position a constant distance forward after the sensor input has entered.

- Functions used: Interrupt input function, pulse latch function
- Configuration example: FMQ1-CM002 plus FMQ1-MMP22 (with pulse I/O)

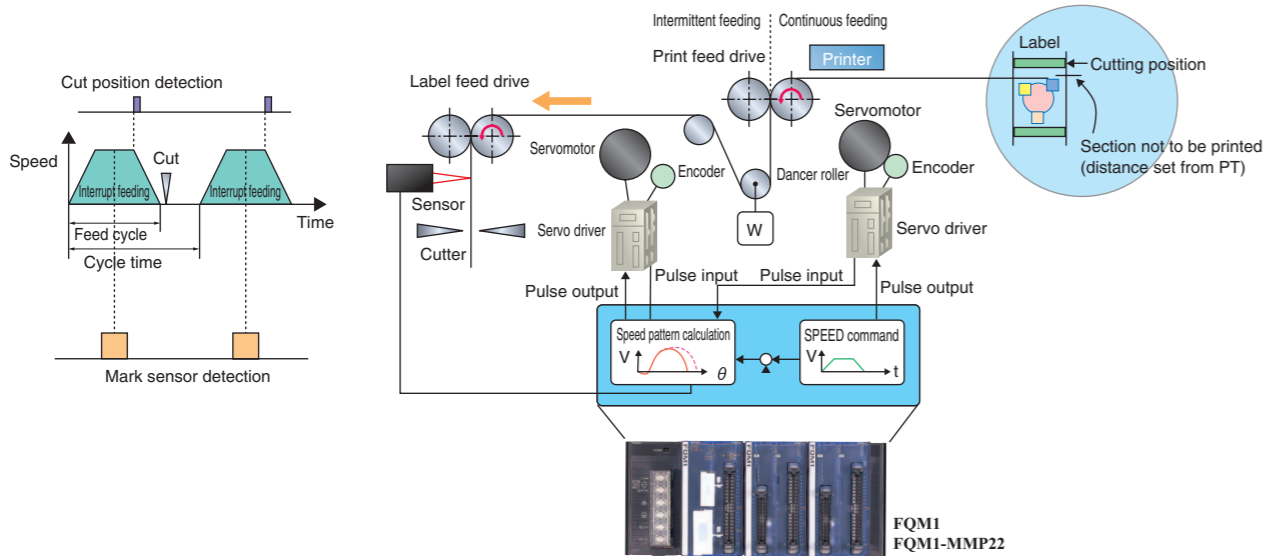

Timing Control with the FMQ1's Pulse Inputs

The pulse input and high-precision output functions of the FMQ1 provide support to perform processing at a specific distance after detection for when processing cannot be performed based on time after an ON/OFF sensor detects an object or when precision is insufficient.

Application Examples **Cutting printing materials** **Nozzle exposure on items flowing at high-speed**

For example, the output can be controlled with high-precision time control after the target number of pulses has been counted after the sensor has been input when processing with high-precision is required at a specified distance advanced (with timing generated from a number of pulses) after the sensor input has been received.

- Functions used: Pulse input-target value match interrupt function, one-shot pulse output function (See note.)
- Configuration example: FMQ1-CM002 plus FMQ1-MMP22 (with pulse I/O)

Note: Also applicable as a 1- s high-precision timer.

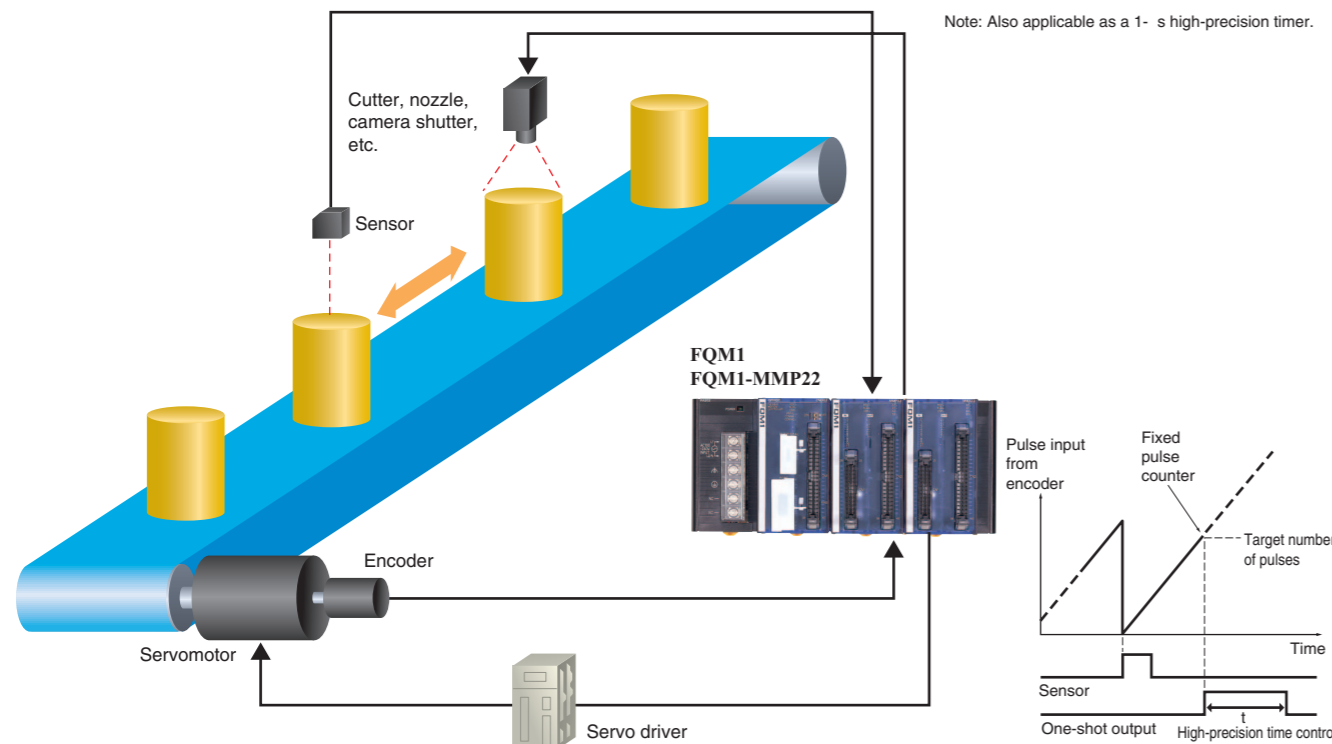

For the Optimal Control Customers Demand for Their Machines Flexible

Flexible System Configuration Using Modular Configuration

The FMQ1 consists of a Power Supply Module, a Coordinator Module, Motion Control Modules, and an End Module. Motion Control Modules are available with pulse I/O or analog I/O, and up to four Motion Control Modules of either type can be connected. (See note.)

Each Motion Control Module controls two axes. Therefore, when four Modules are connected, motion control can be performed for up to eight axes. Also, CJ-series Units can be mounted if an I/O Control Module is used, enabling a flexible system configuration to meet the needs of the application.

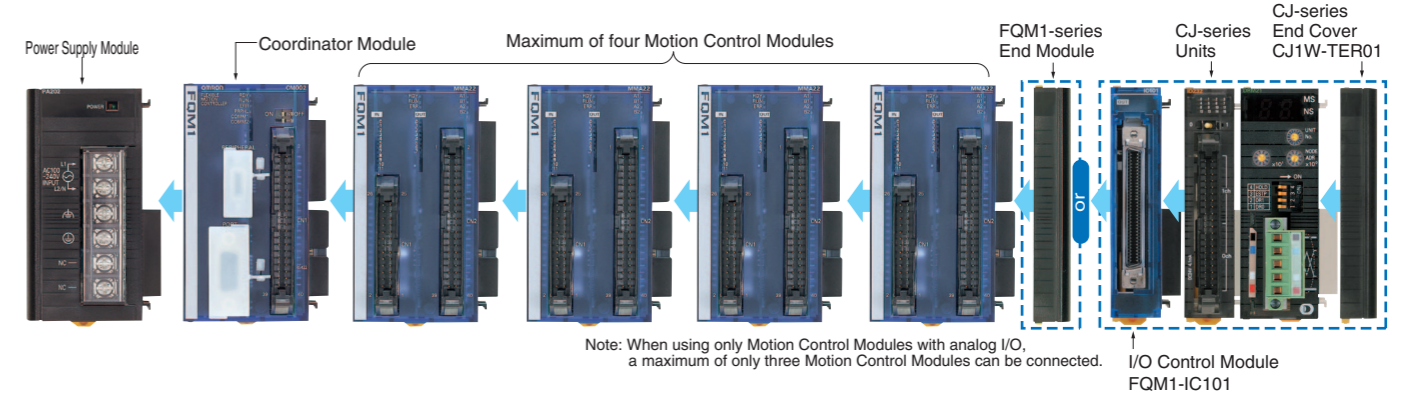

Note: When using only Motion Control Modules with analog I/O, a maximum of only three Motion Control Modules can be connected.

I/O and Other Functions Expandable with CJ-series Units

Some of the PLC SYMAC CJ-series Units can be used by mounting an I/O Control Module for the FMQ1 to the FMQ1. CJ-series Units can be connected on the right end of the FMQ1 or

using the CJ-series I/O Interface Unit with up to one Expansion Rack.

Example 1: Expansion with CJ-series Basic I/O Units

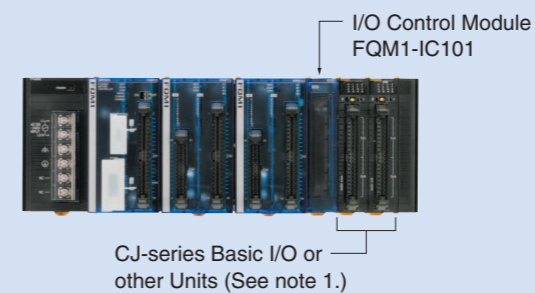

Example 3: I/O Expansion and Reduced Wiring with CompoBus/S

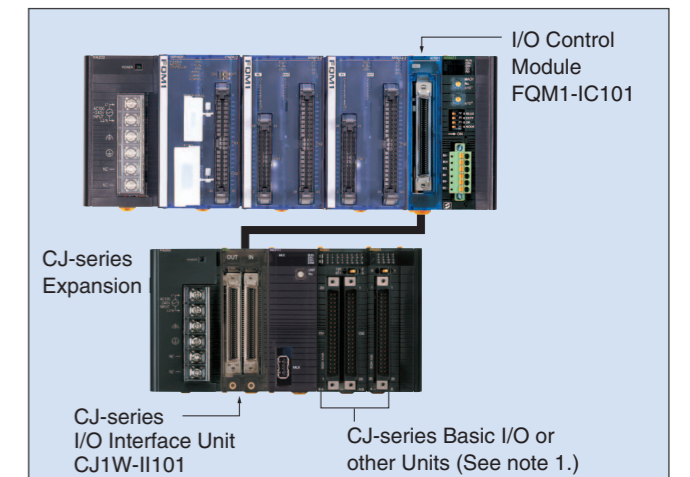
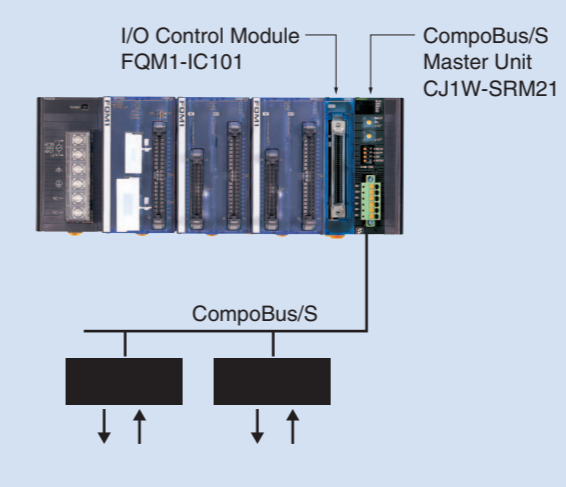

Example 4: Expansion with Multi-axis Position Control Units

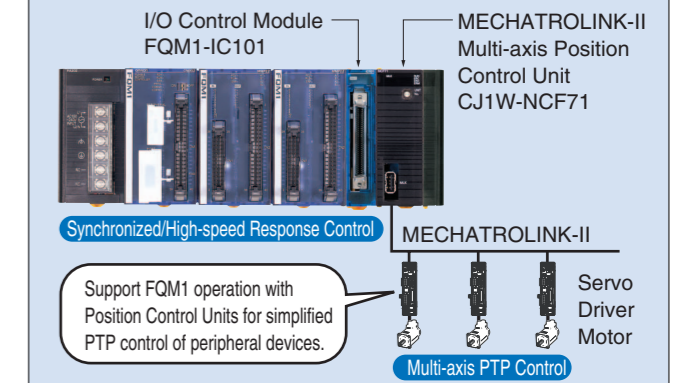

Note 1: The CJ-series Units can be connected as long as the current consumption does not exceed the supply capacity.

For the Optimal Control Customers Demand for Their Machines Flexible

Each Module Controls I/O Directly

The **FQM1** distributes control to each Module, and each Module controls I/O directly. The Motion Control Modules and Coordinator Module independently execute their own ladder programming, enabling independent, high-speed processing of analog and or pulse I/O controls.

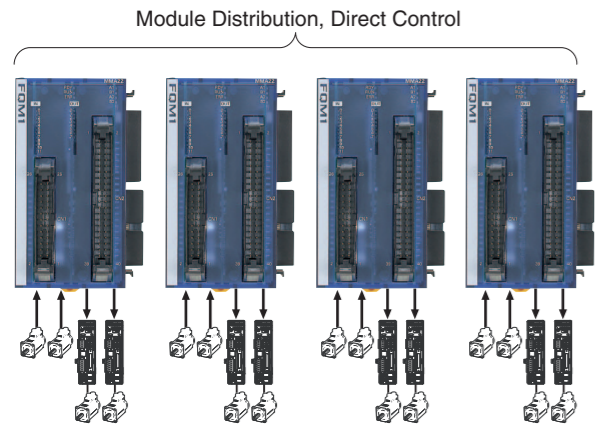

Sync Data Shared between Modules

With the **FQM1**, each Module can broadcast any two types of data as shared data. Data, such as present values of high-speed counters, analog input values, and virtual axes, can be shared between Modules, enabling a wide variety of synchronized control.

• Pulse and Analog I/O Values Can Be Synchronized and Shared

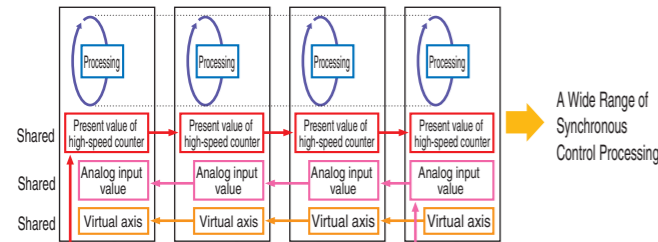

Note: The following types of information can be shared between Modules: Ladder processing results, high-speed counter present values, pulse output present values, analog input values, analog output values, and built-in input values.

Synchronize Up to Eight Axes

With the **FQM1**, each Motion Control Module can control two axes. If you mount four Modules, synchronous control can be performed for up to eight axes.

• Up to Eight Axes Can Be Synchronized (Processing Cycles of All Modules Are Synchronized)

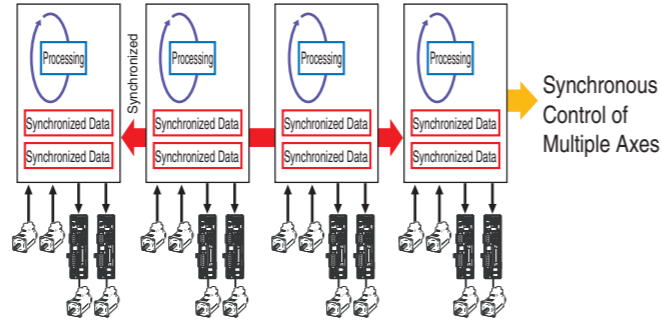

Compatible with Absolute Encoders

A Servo Driver with an absolute encoder can be connected to the **FQM1**.

• Servo Drivers with Absolute Encoders Can Be Used.

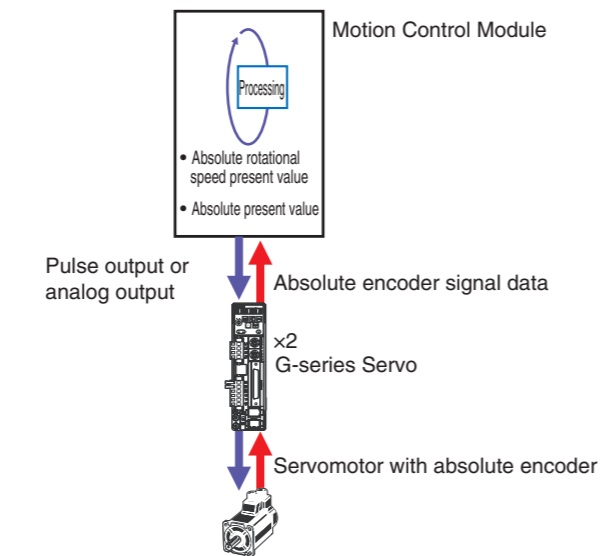

Detailed Programming of Motion Control

With the **FQM1**, each Module contains a user ladder program, enabling programming detailed operations that conventionally could not be implemented by the comparatively conservative processing of specialized motion languages.

• Support for Highly Flexible Programming, such as Control Mode Switching, Operating Condition Changes during Operation, etc.

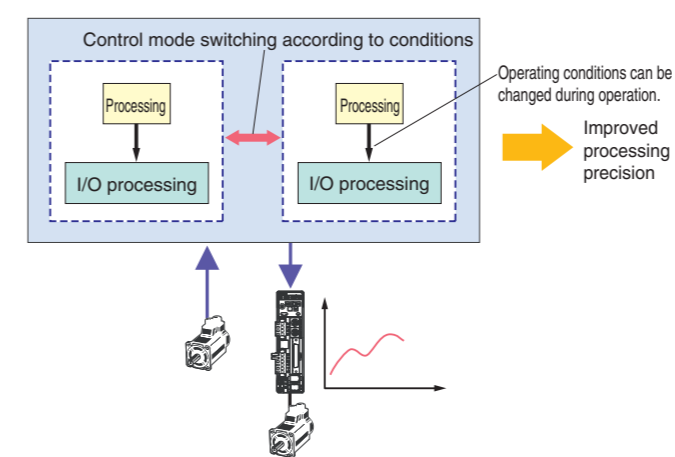

• Ideal Flexible Electronic Cam Operation

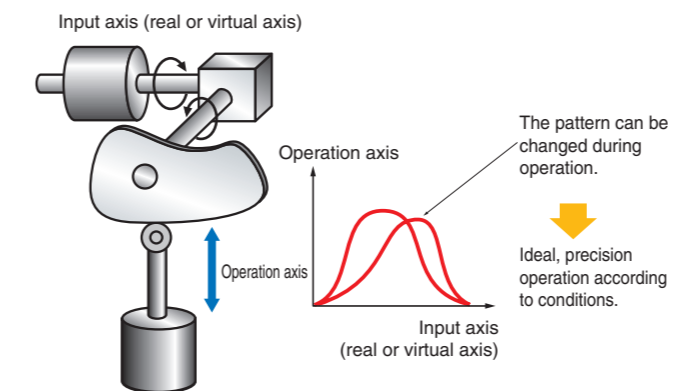

• Tracking Pattern Generation

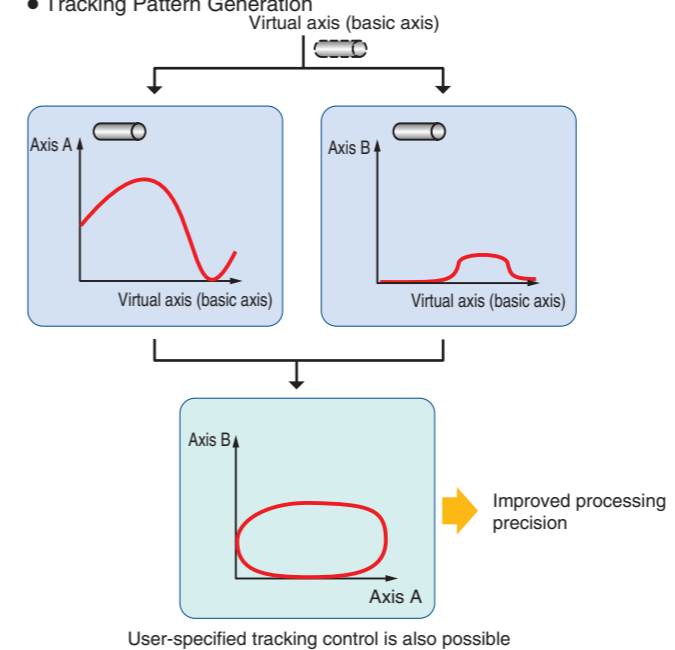

• Generating Ideal Motor Acceleration/Deceleration Patterns

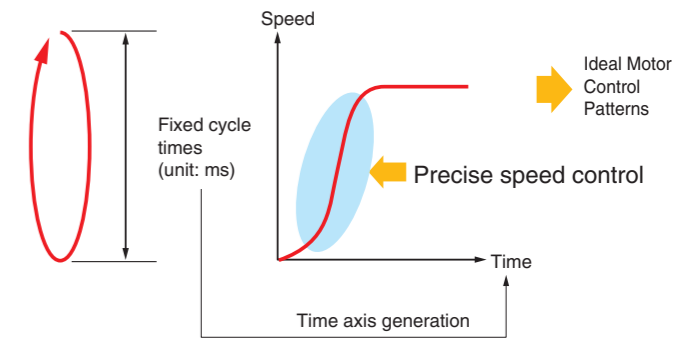

• Operation Switching, such as from Position Control to Speed Control or from Torque Control to Position Control

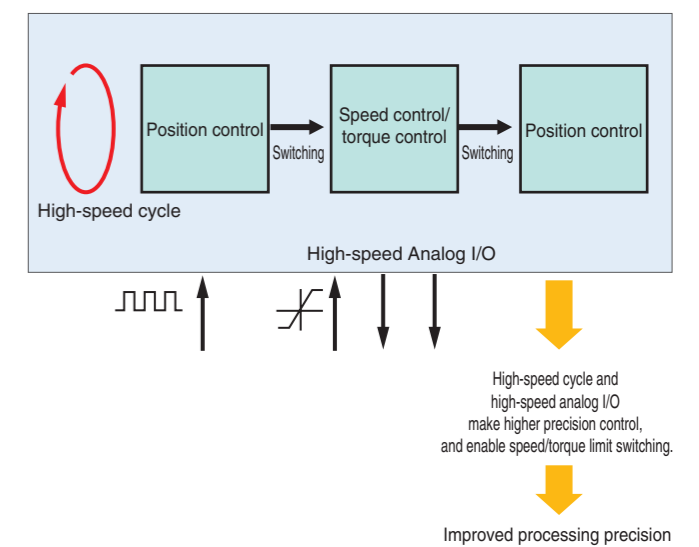

For the Optimal Response Demanded from Your Machines Quick

Parallel Distributed Processing System

Stable Motion Control Cycles for 2 to 8 Axes

With the FQM1, the Coordinator Module and each Motion Control Module have its own application program (ladder diagram). The Coordinator Module processes communications services with peripherals, such as computers and PTs. This enables each Motion Control Module to concentrate on its processing exclusively, as a closed unit, resulting in high-speed motion control cycles of 0.5 to 2 ms (overhead time in cycle time is 0.19 ms min.). Also, even if the number of control axes increases, control is distributed and executed at each Module so that the same stable motion control cycles can be achieved as for only a few control axes.

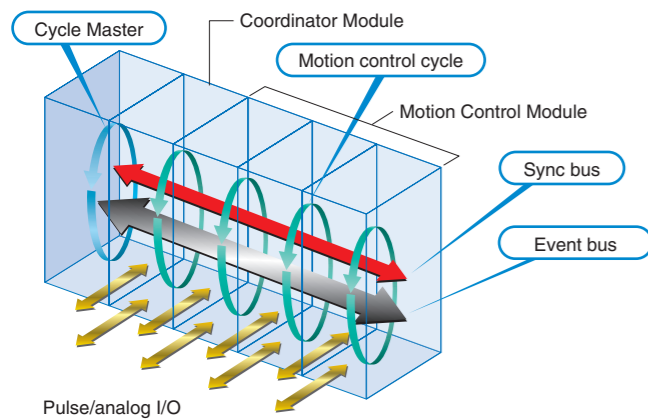

Control Cycles Synced between Axes

FQM1 has a sync bus running between the Modules so that control can be carried out in the same control cycle (Coordinator Module cycle, or specified cycle time between 0.5 and 10.0 ms) while data, e.g., for virtual axes and real axes, is shared among all Motion Control Modules. By making the control cycle of the Coordinator Module constant, it also becomes possible to make the control cycles of the Motion Control Modules constant.

Control cycles can be synchronized and made constant.

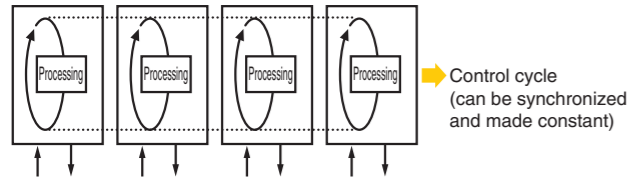

High-speed Processing Performance

High-speed Cyclic Processing Engine Directly Controls Built-in Pulse/Analog I/O

Each FQM1 Motion Control Module has built-in I/O. Therefore each Motion Control Module can perform I/O processing directly as a self-contained unit. Also, the I/O interfaces are designed specifically for speed to enable the following high-speed I/O.

High-speed Pulse Startup

High-speed Pulse Startup at 25 μs Minimum

Examples: Electronic cam pulse output: 32 μs Trapezoidal PTP pulse output: 54 μs

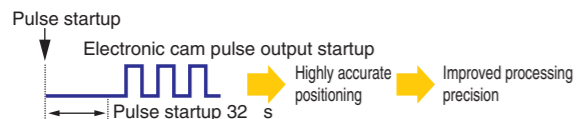

Input Interrupt

Interrupt Response: approx. 70 μs (Not including hardware response time)

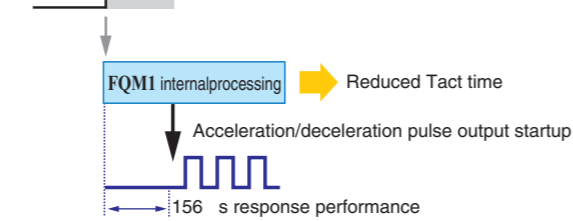

This results in, for example, an interval of 156 μs between an external input and pulse distribution startup when pulses are output for a PTP operation in response to an input interrupt (using the PLS2 instruction).

High-speed Analog I/O

- Analog input conversion: 40 μs
- Analog output conversion: 40 μs

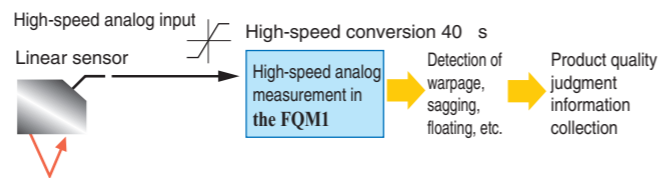

Capturing High-speed Counter Present Value with Hardware Latch

- Latch input response: 30 μs
- Reading captured present value of high-speed counter: Control cycle

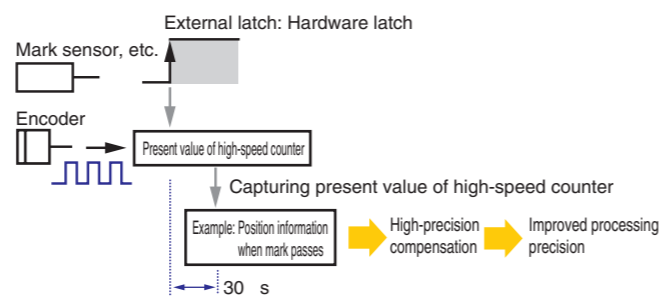

Higher-Frequency Pulse I/O

To support applications demanding high precision, the FQM1 has increased the frequencies for pulse I/O.

- Pulse input: 500 kHz (phase difference with multiple of 4: 2 MHz)
- Pulse output: Maximum output frequency of 1 MHz

High-speed Pulse Inputs

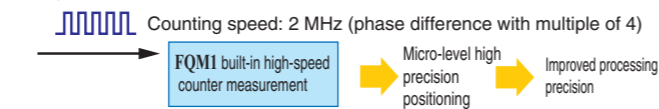

High-speed Pulse Outputs

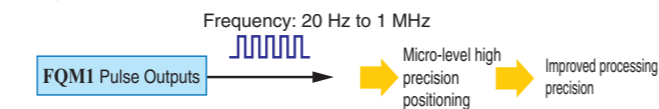

High-speed Analog Outputs

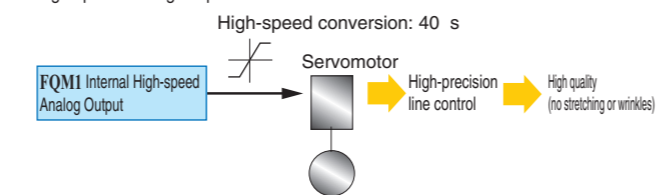

Program Development Environment

Application program development is as easy for the FQM1 as for a PLC.

Connect the CX-Programmer Support Software to the Coordinator Module to create and monitor programs for all Modules.

While monitoring the ladder programs in Motion Control Modules, it is possible to input operation conditions for monitoring the I/O of the Coordinator Module, and to debug programs.

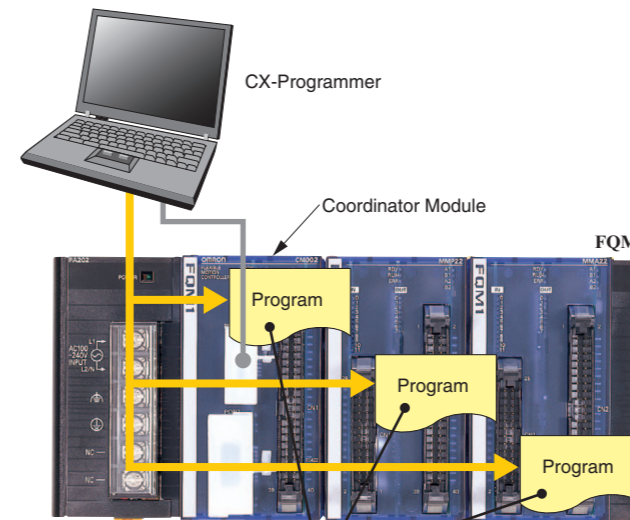

Ladder programs for the Coordinator Module and all Motion Control Modules can be created, transferred, and monitored.

FQM1 Manage the FQM1 Module Configuration on a Directory Tree on the Support Software.

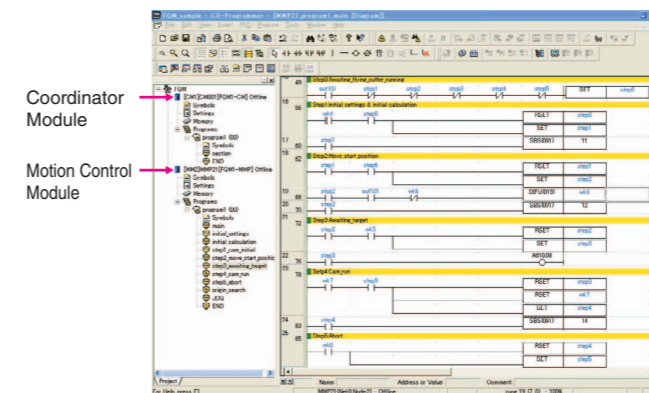

Note: Use CX-Programmer version 6.11 or higher with the FQM1.

Set the Module Operations on the System Setup Window

System Setup, such as the FQM1 synchronous/asynchronous mode setting, to determine the FQM1 operation modes are required along with creating application programs and can be selected in special windows.

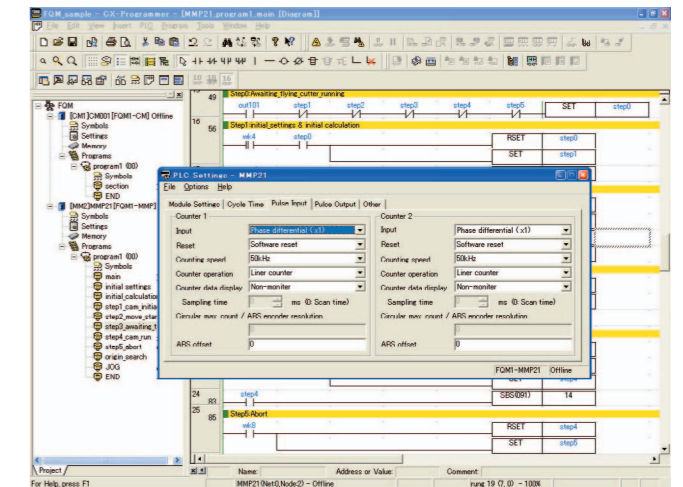

Function Block (Ladder Programming and ST Language) Support Further Improve Development Efficiency and Maintenance.

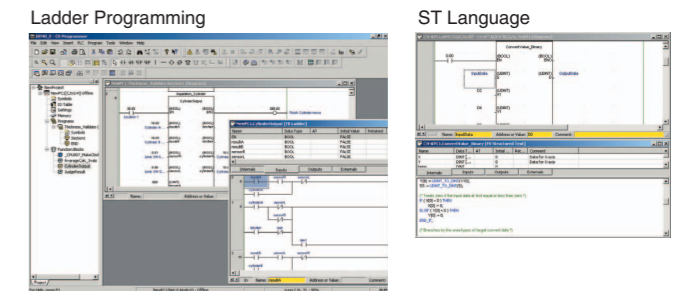

Calculation processing can be written with Structured Text

Efficiency of development and maintenance is increased for motion control applications with a lot of calculation processing.

Name	Data Type	AT	Initial Value	Retained	Comment
EN	BOOL		FALSE		Controls execution of the Function Block.
r	REAL		0.0		Radius
theta	REAL		0.0		Angle
p	REAL		0.0		center coordinate: p
q	REAL		0.0		Center coordinate: q

Internals	Inputs	Outputs	Externals
(* calculate circular arc coordinate *)			
(* Radius: r, Center coordinate: p, q *)			
(* x-coordinate: x, y-coordinate: y *)			
x := r * cos(theta) + p;			
y := r * sin(theta) + q;			

Connecting Peripherals

Serial communications systems can be constructed with the host PLC.

- Host Links with CS/CJ-series PLCs
- Serial PLC Links with CJ1M PLCs

Serial Communications with the Host PLC

FQM1 data can be read and written using communications instructions from the host PLC.

Equipped with Host Link Functions as Standard Feature: Coordinator Module

By mounting a Serial Communications Unit (of Unit version 1.2 or later) to a CS/CJ-series PLC, accessed data can be read and written for the FQM1 using the SEND/RECV network communications instructions with the CS/CJ-series PLC as the Host Link master and the FQM1 as the Host Link slave (using the RS-232C port on the Coordinator Module).

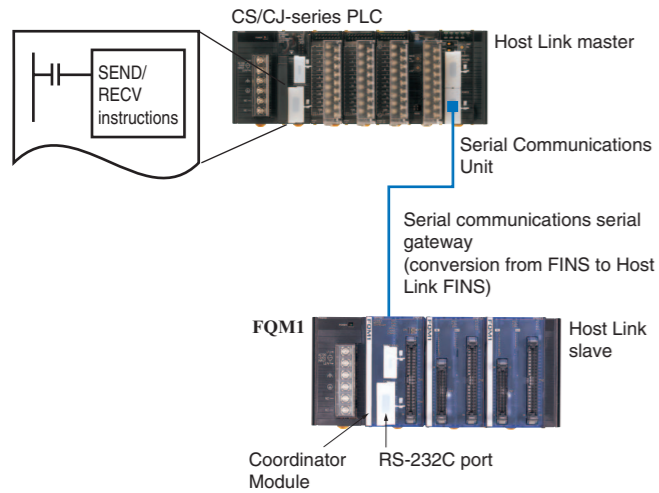

Seamless Data Exchange with Host Controllers

Serial PLC Links Supported

(Data Sharing with the OMRON CJ1M PLC)
Exchange of control data with the machine's main controller (PLC) can be performed without any special programming. With the CJ1M CPU Unit as master and the FQM1 as slave, data can be exchanged between the two without special programming. Connect the FQM1 Coordinator Module to the RS-232C port.

- Note 1: The master link method and complete link method for Serial PLC Links are supported.
Note 2: When connecting 1:N (where N = 8 units max.) via RS-422A/485, use an RS-422A converter (CJ1W-CIF11).

The maximum size of each CJ1M/FQM1 transmission is ten words. Transmissions smaller than ten words (unified CJ1M/FQM1 size) can also be sent (set as the number of link words).

System Configuration

- CJ1M: FQM1 = 1:1 Connection

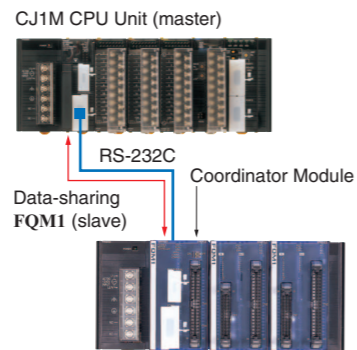

- CJ1M: FQM1 = 1:N (8 Max.) Connection

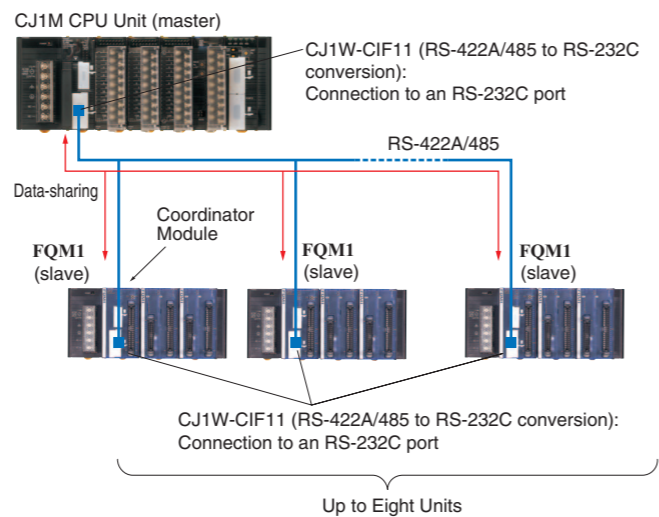

Reference information:
In the complete link method, the CJ1M CPU Unit will be the master and data transfer will be possible among the FQM1 slaves.

Connecting Peripherals

Construct Touch Panel (PT) Systems and DeviceNet Systems.

- NS-series PTs supported.
- DeviceNet supported.

Serial Communications with NS-series PTs

Easy Servo Parameter Setup/Monitoring from NS-series PTs

Serial Gateway Function (Built-in RS-422A for Connecting to Servo)

Servo parameters and other data can be read or written from an NS-series PT or computer (application running on the CX-Server) via the FQM1 Coordinator Module for servo drivers connected by RS-422A.

This makes it easy to enter servo driver parameter settings at system startup, and to monitor operation.

- RS-422A-compatible Servo Drivers
OMRON W-series or SMARTSTEP

System Configuration

Example: Accessing a Servo Driver (W-series or SMARTSTEP) Using Smart Active Parts on an NS-series PT Connected Using an NT Link

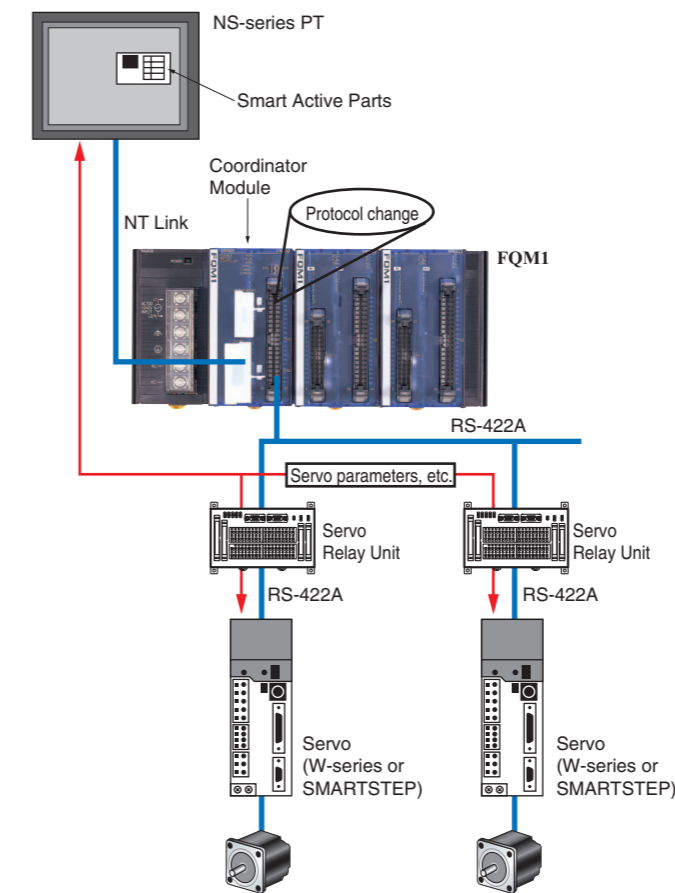

Note:
The Servo Relay Unit has a built-in RS-422A connector for connecting to the FQM1.

DeviceNet communications with the host controller

Data can be exchanged with the host controller using DeviceNet without special programming.

Add a DeviceNet Slave Function

Remote I/O communications will be possible between the host controller (master) and FQM1 (slave) if the FQM1 is expanded using an I/O Control Module and the slave function of a CJ-series DeviceNet Unit.

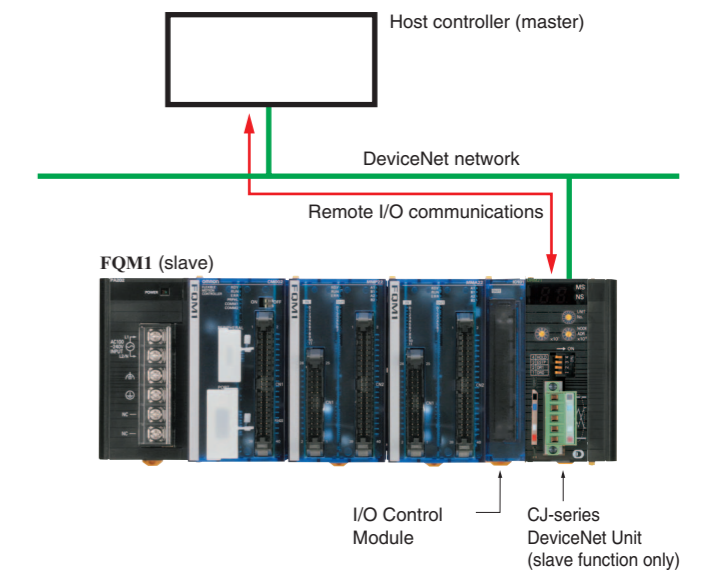

Expansion Possible Using CJ-series Units

Expansion Is Performed through an I/O Control Module (for Bus Conversion and I/O Expansion)

- CJ-series Basic I/O Units
- Special Units Including Analog Units, DeviceNet Units, Position Control Units and High-speed Data Collection Units
- CJ-series Expansion Rack (The above Units can be mounted; one Rack only.)

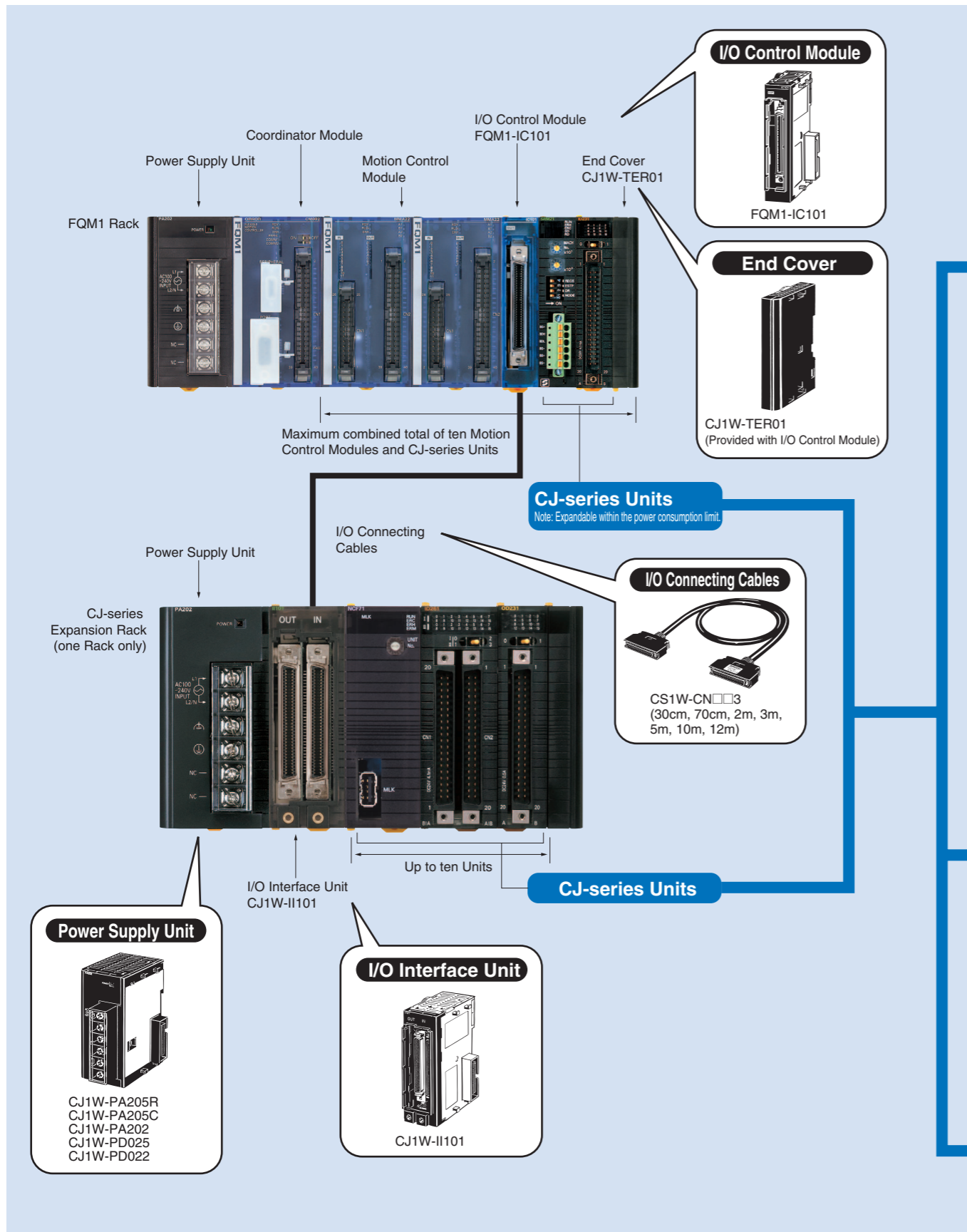

CJ-series Units for FQM1 Expansion

Basic I/O Units

● Input Units



16-point DC Input Units
CJ1W-ID201/211



32-point DC Input Units
CJ1W-ID231

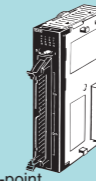

32-point DC Input Units
CJ1W-ID232

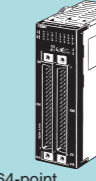

64-point DC Input Units
CJ1W-ID261

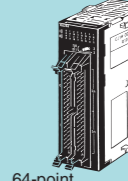

64-point DC Input Units
CJ1W-ID262



8-point/64-point AC Input Units
CJ1W-IA111/201

● Output Units

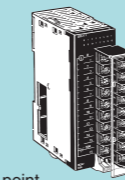

8-point Transistor Output Units
CJ1W-OD20□

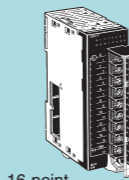

16-point Transistor Output Units
CJ1W-OD211/212



32-point Transistor Output Units
CJ1W-OD231



32-point Transistor Output Units
CJ1W-OD232/233

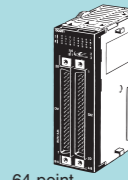

64-point Transistor Output Units
CJ1W-OD261

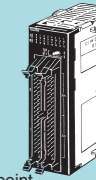

64-point Transistor Output Units
CJ1W-OD262/263

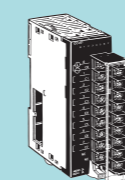

8-point (Independent) Relay Contact Output Unit
CJ1W-OC201



16-point Relay Contact Output Unit
CJ1W-OC211



8-point Triac Output Unit
CJ1W-OA201

● I/O Units

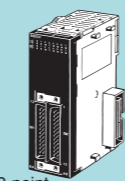

32-point DC Input/Transistor Output Units
CJ1W-MD231



32-point DC Input/Transistor Output Units
CJ1W-MD232/233



64-point DC Input/Transistor Output Units
CJ1W-MD261

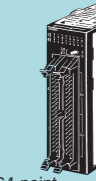

64-point DC Input/Transistor Output Units
CJ1W-MD263

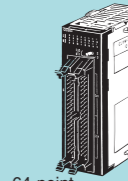

64-point TTL I/O Unit
CJ1W-MD563

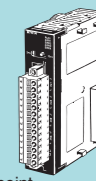

64-point B7A Interface Units
CJ1W-B7A□□

Special I/O Units

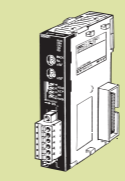

CompoBus/S Master Unit
CJ1W-SRM21

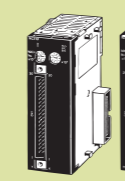

Position Control Unit
CJ1W-NC□□3

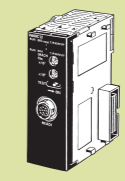

ID Sensor Unit
CJ1W-V600C11/
V600C12

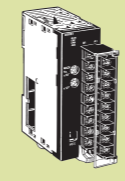

Analog Input Unit
CJ1W-AD081-V1
CJ1W-AD041-V1
(8-point/4-point)

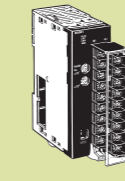

Analog Output Unit
CJ1W-DA08V/08C
CJ1W-DA041/021
(8-point/4-point/2-point)

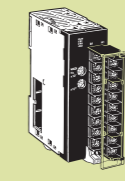

Analog I/O Unit
CJ1W-MAD42
(AD 4-point/DA 2-point)

CPU Bus Units

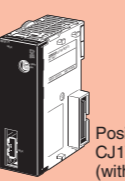

Position Control Unit
CJ1W-NC□71
(with MECHATROLINK-II)

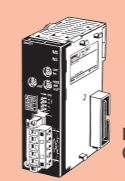

DeviceNet Unit
CJ1W-DRM21

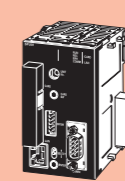

High-speed Data Collection Unit
CJ1W-SPU01-V2

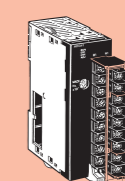

Analog Input Unit
(High-speed type)
CJ1W-ADG41

Flexible Motion Controllers

FQM1 Series

Advanced Power in Three Applications: Motion Control, Measurement Control, and High-speed Response Control FQM (Flexible Quick Motion)[®]



- Flexibility, quickness, and a wide range of advanced motion operations enable the FQM1 to easily handle applications in the following three control areas.

1. Motion control
2. Measurement control
3. High-speed response control

- Expansion Possible Using CJ-series Units

Therefore, the FQM1 supports I/O expansion, communications slaves, multi-axis control, and data storage.

- Function blocks and structured text (ST) programming are supported.
- Ideal for Applications Performing Processing without Stopping Machinery Operation.

System Configuration

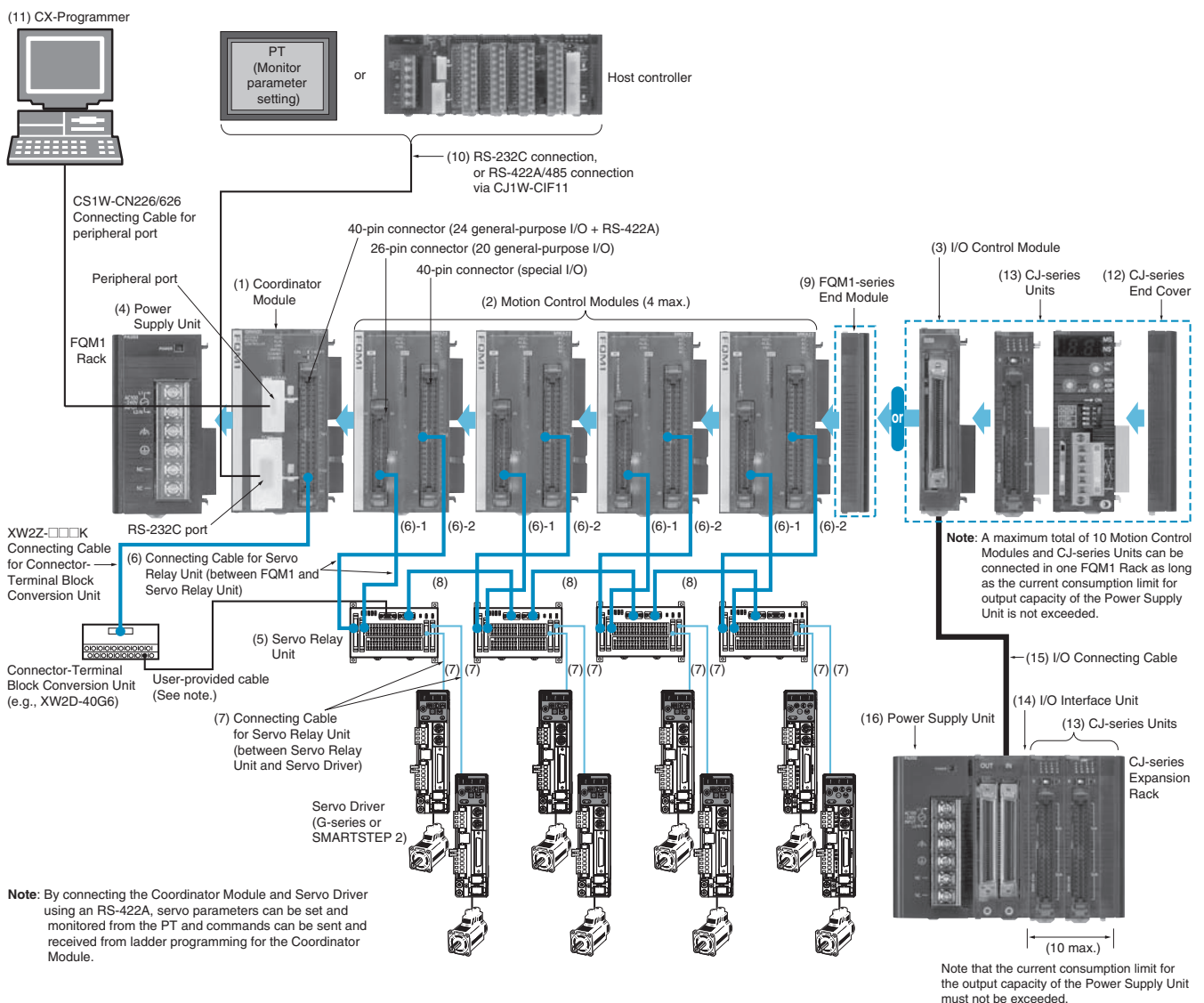

Ordering Information

Basic Sets

Name	Specifications	Model	Standards
FQM1 Pulse Set	A basic set for pulse outputs and 2 axes (3) CJ1W-PA202 + (1) FQM1-CM002 + (2) FQM1-MMP22 + (9) FQM1-TER01	FQM1S-MC233 (See note 1.)	CE, UL approval pending (See note 2.)
FQM1 Analog Set	A basic set for analog outputs and 2 axes (3) CJ1W-PA205R + (1) FQM1-CM002 + (2) FQM1-MMA22 + (9) FQM1-TER01	FQM1S-MC224 (See note 1.)	CE, UL approval pending (See note 2.)

Note: 1. The I/O Control Module (FQM1-IC101) is not included.
2. UL-approved products are scheduled for shipment in March 2006.

Basic Modules

No. in diagram	Name	Specifications	Current consumption (A)		Model	Standards
			5 V	24 V		
(1)	Coordinator Module	Program capacity: 10 Ksteps, DM Area capacity: 32 Kwords, Built-in I/O (16 inputs and 8 outputs), I/O Area for CJ-series Basic I/O Unit: 320 bits, Serial PLC Link Area: 1,440 bits, DeviceNet Area: 9,600 bits, Built-in peripheral port, RS-232C port, and RS-422 port	0.37	–	FQM1-CM002 (See note 1.)	CE, UL approval pending (See note 2.)
(2)	Motion Control Modules	Program capacity: 10 Ksteps, DM Area capacity: 32 Kwords, Built-in I/O: 12 inputs and 8 outputs), two pulse inputs, two pulse outputs	0.824	–	FQM1-MMP22	CE, UL approval pending (See note 2.)
		Program capacity: 10 Ksteps, DM Area capacity: 32 Kwords, Built-in I/O (12 inputs and 8 outputs), 2 pulse inputs, 1 analog input, 2 analog outputs	0.772	0.095	FQM1-MMA22	CE, UL approval pending (See note 2.)
(3)	I/O Control Module	Used when CJ-series Units are connected to the FQM1. A CJ-series Expansion Rack can be connected at the same time.	0.02	–	FQM1-IC101 (See note 1.)	UL approval pending (See note 4.), CE
(4)	Power Supply Unit	100 to 240 VAC, output capacity: 2.8 A at 5 VDC, 0.4 A at 24 VDC, total power consumption: 14 W			CJ1W-PA202	UC1, CE, N, L
		100 to 240 VAC (with RUN output), output capacity: 5 A at 5 VDC, 0.8 A at 24 VDC, total power consumption: 25 W			CJ1W-PA205R	
		100 to 240 VAC, replacement time notification function, no RUN output, Output capacity: 5 A at 5 VDC, 0.8 A at 24 VDC, total power consumption: 25 W			CJ1W-PA205C	

Note: 1. A FQM1-TER01 End Module is included.
2. UL-approved products are scheduled for shipment in March 2006.

Servo Relay Unit and Cables

Servo Relay Unit

No. in diagram	Name	Compatible Units	Compatible Drivers	Number of axes	Model	Standards
(5)	Servo Relay Unit	FQM1	OMNUC G-series/SMARTSTEP 2	For two axes	XW2B-80J7-12A <i>NEW</i>	–
		FQM1/CS1W-HCP	OMNUC W-series/SMARTSTEP Junior/A-series	For two axes	XW2B-80J7-1A	

Connecting Cable on Position Control Unit for Servo Relay Unit

No. in diagram	Name	Compatible Drivers		Specifications	Cable length	Model	Standards
(6)-1	Connecting Cable on Position Control Unit	OMNUC G/W-series	R88D-GT/WT	General-purpose I/O (26-pin connector)	0.5m	XW2Z-050J-A28	–
					1m	XW2Z-100J-A28	
					2m	XW2Z-200J-A28	
(6)-2		Special I/O (40-pin connector)	0.5m	XW2Z-050J-A31			
			1m	XW2Z-100J-A31			
			2m	XW2Z-200J-A31			
(6)-1	OMNUC G/W-series, SMARTSTEP 2, SMARTSTEP Junior/A-series	R88D-GT/WT, R7D-BP/ZP/AP	General-purpose I/O (26-pin connector)	0.5m	XW2Z-050J-A28		
				1m	XW2Z-100J-A28		
				2m	XW2Z-200J-A28		
(6)-2		Special I/O (40-pin connector)	0.5m	XW2Z-050J-A30			
			1m	XW2Z-100J-A30			
			2m	XW2Z-200J-A30			

FQM1 Series

Connecting Cable on Servo Driver for Servo Relay Unit

No. in diagram	Name	Compatible Units	Compatible Drivers		Cable length	Model	Standards
(7)	Connecting Cable on Servo Driver	Motion Control Module FQM1-MMA22	OMNUC G-series	For R88D-GT	1m	XW2Z-100J-B27 <i>NEW</i>	-
					2m	XW2Z-200J-B27 <i>NEW</i>	
			OMNUC W-series	For R88D-WT	1m	XW2Z-100J-B13	
					2m	XW2Z-200J-B13	
					1m	XW2Z-100J-B21	
					2m	XW2Z-200J-B21	
					1m	XW2Z-100J-B22	
					2m	XW2Z-200J-B22	
		Motion Control Module FQM1-MMP22	SMARTSTEP 2	For R7D-BP	1m	XW2Z-100J-B30 <i>NEW</i>	
					2m	XW2Z-200J-B30 <i>NEW</i>	
			OMNUC G-series	For R88D-GT	1m	XW2Z-100J-B26 <i>NEW</i>	
					2m	XW2Z-200J-B26 <i>NEW</i>	
			SMARTSTEP Junior	For R7D-ZP	1m	XW2Z-100J-B20	
					2m	XW2Z-200J-B20	
			SMARTSTEP A-series	For R7D-AP	1m	XW2Z-100J-B10	
					2m	XW2Z-200J-B10	
OMNUC W-series	For R88D-WT	1m	XW2Z-100J-B9				
		2m	XW2Z-200J-B9				
1m	XW2Z-100J-B23						
2m	XW2Z-200J-B23						

RS-422A Communications Cable between Servo Relay Units

No. in diagram	Name	Specifications	Cable length	Model	Standards
(8)	RS-422A Communications Cable between Servo Relay Units	-	1m	XW2Z-100J-C1	-
			2m	XW2Z-200J-C1	

Connecting Cable with NS-series PTs

No. in diagram	Name	Specifications		Model	Standards
		Connection Format	Cable length		
-	Connecting Cable with NS-series PTs	Connecting Cable between NS-series PT and RS-232C port on Coordinator Module	2m	XW2Z-200T	-
			5m	XW2Z-500T	
		Connecting Cable between NS-series PT and peripheral port on Coordinator Module	2m	XW2Z-200T-2	
			5m	XW2Z-500T-2	

Others

No. in diagram	Name	Specifications	Model	Standards
(9)	End Module	Connected to the right end of the FQM1 Rack. Provided with the FQM1 Sets and with the FQM1-CM002.	FQM1-TER01	UC1, CE
	DIN Track	Track length: 0.5 m, Height: 7.3 mm	FPF-50N	-
		Track length: 1 m, Height: 7.3 mm	FPF-100N	-
		Track length: 1 m, Height: 16 mm	FPF-100N2	-
	End Plate	Placed on both ends of the Controller on the DIN Track to hold the Controller in place. Two End Places are provided with the FQM1 Sets and with the FQM1-CM002.	FPF-M	-
(10)	RS-422A Adapter	Converts RS-232C to RS-422A/485.	CJ1W-CIF11	UC, CE, N

Support Software

No. in diagram	Name	Specifications	Specifications		Model	Standards
			Number of licenses	Media		
(11)	CX-One FA Integrated Tool Package Ver. 3.□	The CX-One is a package that integrates the Support Software for OMRON PLCs and components. CX-One runs on the following OS. Windows 2000 (Service Pack 3a or higher), XP, or Vista CX-One Ver.3.□ includes CX-Programmer Ver.8.□. For details, refer to the CX-One catalog (Cat. No. R134).	1 license (See note 1.)	CD	CXONE-AL01C-V3	-
				DVD (See note 2.)	CXONE-AL01D-V3	
	CX-Programmer can still be ordered individually in the following model numbers.					
	CX-Programmer Ver.8.□	PLC programming software OS: Windows 2000 (Service Pack 3a or higher), XP, or Vista	1 license	CD	WS02-CXPC1-V8	-
			3 licenses	CD	WS02-CXPC1-V8L03	-
10 licenses			CD	WS02-CXPC1-V8L10	-	

Note: 1. Site licenses are available for the CX-One (3, 10, 30, or 50 licenses).

2. When purchasing the DVD format, verify the computer model and DVD drive specifications before purchasing.

Compatible CJ-series Units

No. in diagram	Name	Specifications	Current consumption (A)		Model	Standards	
			5 V	24 V			
(12)	CJ-series End Cover	Mounted on the right end when CJ-series Units are used for expansion.	-		CJ1W-TER01	UC1, CE, N, L	
(13)	Input Units	DC Input Units	Terminal block, 12 to 24 VDC, 10 mA, 8 inputs	0.09	-	CJ1W-ID201	UC1, CE, N, L
			Terminal block, 24 VDC, 7 mA, 16 inputs	0.08	-	CJ1W-ID211	
			Fujitsu connector, 24 VDC, 4.1 mA, 32 inputs	0.09	-	CJ1W-ID231 (See note 1.)	
			MIL connector, 24 VDC, 4.1 mA, 32 inputs	0.09	-	CJ1W-ID232 (See note 1.)	
			Fujitsu connector, 24 VDC, 4.1 mA, 64 inputs	0.09	-	CJ1W-ID261 (See note 1.)	
			MIL connector, 24 VDC, 4.1 mA, 64 inputs	0.09	-	CJ1W-ID262 (See note 1.)	
			AC Input Units	Terminal block, 100 to 120 VAC, 7 mA (100 V, 50 Hz), 16 inputs	0.09	-	
	Terminal block, 200 to 240 VAC, 10 mA (200 V, 50 Hz), 8 inputs	0.08		-	CJ1W-IA201		
	Output Units	Relay Contact Output Units	Terminal block, 250 VAC/24 VDC max., 2 A, 8 outputs, independent contacts	0.09	0.048 (0.006 × number of points ON)	CJ1W-OC201	UC1, CE, N, L
			Terminal block, 250 VAC/24 VDC max., 2 A, 16 outputs, independent contacts	0.11	0.06 (0.006 × number of points ON)	CJ1W-OC211	
		Transistor Output Units	Terminal block, 12 to 24 VDC, 2 A, 8 sinking outputs	0.09	-	CJ1W-OD201	
			Terminal block, 24 VDC, 2 A, 8 sourcing outputs, load short-circuit protection, wiring disconnect detection, and alarm function	0.11	-	CJ1W-OD202	
			Terminal block, 12 to 24 VDC, 0.5 A, 8 sinking outputs	0.10	-	CJ1W-OD203	
			Terminal block, 24 VDC, 0.5 A, 8 sourcing outputs, load short-circuit protection, and alarm function	0.10	-	CJ1W-OD204	
			Terminal block, 12 to 24 VDC, 0.5 A, 16 sinking outputs	0.10	-	CJ1W-OD211	
			Terminal block, 24 VDC, 0.5 A, 16 sourcing outputs, load short-circuit protection, and alarm function	0.10	-	CJ1W-OD212	
			Fujitsu connector, 12 to 24 VDC, 0.5 A, 32 sinking outputs	0.14	-	CJ1W-OD231 (See note 1.)	
MIL connector, 12 to 24 VDC, 0.5 A, 32 sourcing outputs, load short-circuit protection, and alarm function			0.15	-	CJ1W-OD232 (See note 1.)		
MIL connector, 12 to 24 VDC, 0.5 A, 32 sinking outputs	0.14	-	CJ1W-OD233 (See note 1.)				
Fujitsu connector, 12 to 24 VDC, 0.3 A, 64 sinking outputs	0.17	-	CJ1W-OD261 (See note 1.)				
MIL connector, 12 to 24 VDC, 0.3 A, 64 sourcing outputs	0.17	-	CJ1W-OD262 (See note 1.)				
MIL connector, 12 to 24 VDC, 0.3 A, 64 sinking outputs	0.17	-	CJ1W-OD263 (See note 1.)				
Triac Output Unit	Terminal block, 250 VAC, 0.6 A, 8 outputs	0.22	-	CJ1W-OA201			

FQM1 Series

No. in diagram	Name	Specifications		Current consumption (A)		Model	Standards	
				5 V	24 V			
(13)	I/O Units	DC Input/ Transistor Output Units	24 VDC, 7 mA, 16 inputs	Fujitsu connector	0.13	-	CJ1W-MD231 (See note 2.)	UC1, N, CE
			12 to 12 VDC, 0.5 A, 16 sinking outputs					
			24 VDC, 7 mA, 16 inputs	MIL connector	0.13	-	CJ1W-MD232 (See note 2.)	UC1, N, L, CE
			24 VDC, 0.5 A, 16 sourcing outputs, load short-circuit protection, and alarm function					
			24 VDC, 4.1 mA, 16 inputs	MIL connector	0.13	-	CJ1W-MD233 (See note 2.)	UC1, CE, N
			12 to 24 VDC, 0.5 A, 16 sinking outputs					
			24 VDC, 4.1 mA, 32 inputs	Fujitsu connector	0.14	-	CJ1W-MD261 (See note 1.)	
			12 to 24 VDC, 0.3 A, 32 sinking outputs	MIL connector	0.14	-	CJ1W-MD263 (See note 1.)	
			24 VDC, 4.1 mA, 32 inputs					
	12 to 24 VDC, 0.3 A, 32 sinking outputs	MIL connector	0.19	-	CJ1W-MD563 (See note 1.)			
	5 VDC, 3.5 mA, 32 inputs							
	TTL I/O Unit	5 VDC, 3.5 mA, 32 inputs						
	B7A Interface Unit	64 inputs	0.07	-	CJ1W-B7A14	UC1, CE		
		64 outputs	0.07	-	CJ1W-B7A04			
		32 inputs/32 outputs	0.07	-	CJ1W-B7A22			
	CJ-series Special I/O Units	CompoBus/S Master Units	Communications functions: Remote I/O communications Maximum number of I/O points: 256 (128 inputs/128 outputs) or 128 (64 inputs/64 outputs)		0.15	-	CJ1W-SRM21	UC1, CE, N, L
		ID Sensor Unit	Data transfer speed: 160 bytes/scan (between CPU Unit and ID Sensor Unit)		0.26	0.12	CJ1W-V600C11	UC, CE
					0.32	0.24	CJ1W-V600C12	
		Position Control Unit	Pulse train open collector/ Line driver output type	1 axis	0.25	-	CJ1W-NC113/133	UC1, CE
				2 axes		-	CJ1W-NC213/233	
				4 axes		-	CJ1W-NC413/433	
		Analog Input Unit	Number of inputs: 8 Signal range: 1 or 5 V; 0 to 5 V, 0 to 10 V, ±10 V, 4 to 20 mA Resolution: 1/8000 (available to set to 1/4000) (see note 1.) Conversion speed: 250 µs/point max. (available to set to 1 ms/point) (see note 1.) Accuracy (ambient temperature: 25°C): Voltage: ±0.2% of F.S. Current: ±0.4% of F.S. (see note 2.)		0.42	-	CJ1W-AD081-V1	UC1, N, L, CE
			Number of inputs: 4 Signal range: 1 or 5 V; 0 to 5 V, 0 to 10 V, ±10 V, 4 to 20 mA Resolution: 1/8000 (available to set to 1/4000) (see note 1.) Conversion speed: 250 µs/point max. (available to set to 1 ms/point) (see note 1.) Accuracy (ambient temperature: 25°C): Voltage: ±0.2% of F.S. Current: ±0.4% of F.S. (see note 2.)					
		Analog Output Units	Number of outputs: 8 Signal range: 1 or 5 V; 0 to 5 V, 0 to 10 V, -10 to 10 V Resolution: 1/4000 (available to set to 1/8000) Conversion speed: 1 ms/point (available to set to 250 µs/point max.) Accuracy (ambient temperature: 25°C): ±0.3% of F.S. External connection: Removable terminal block External power supply: 24 VDC, 140 mA max.		0.14	0.14 (See note 3.)	CJ1W-DA08V	UC1, N, L, CE
			Number of outputs: 8 Signal range: 4 to 20 mA Resolution: 1/4000 (available to set to 1/8000) Conversion speed: 1 ms/point (available to set to 250 µs/point max.) Accuracy (ambient temperature: 25°C): ±0.3% of F.S. External connection: Removable terminal block External power supply: 24 VDC ^{-10%} / _{-15%} , 170 mA max.					
	Number of outputs: 4 Signal range: 1 or 5 V; 0 to 5 V, 0 to 10 V, -10 to 10 V, 4 to 20 mA Resolution: 1/4000 Conversion speed: 1 ms max./point Accuracy (ambient temperature: 25°C): Voltage output: ±0.3% of F.S. Current output: ±0.5% of F.S. External connection: Removable terminal block External power supply: 24 VDC ^{-10%} / _{-15%} , 200 mA max.							
	Number of outputs: 2 Signal range: 1 or 5 V; 0 to 5 V, 0 to 10 V, -10 to 10 V, 4 to 20 mA Resolution: 1/4000 Conversion speed: 1 ms max./point Accuracy (ambient temperature: 25°C): Voltage output: ±0.3% of F.S. Current output: ±0.5% of F.S. External connection: Removable terminal block External power supply: 24 VDC ^{-10%} / _{-15%} , 140 mA max.							

No. in diagram	Name	Specifications	Current consumption (A)		Model	Standards	
			5 V	24 V			
(13)	CJ-series Special I/O Units Analog I/O Units	Number of inputs: 4 Signal range: 1 or 5 V; 0 to 5 V, 0 to 10 V, -10 to 10 V, 4 to 20 mA Resolution: 1/4000 (available to set to 1/8000) Conversion speed: 1 ms/point (available to set to 500 μs/point max.) Accuracy (ambient temperature: 25°C): Voltage: ±0.2% of F.S. Current: ±0.2% of F.S.	0.58	-	CJ1W-MAD42	UC1, N, L, CE	
		Number of outputs: 2 Signal range: 1 or 5 V; 0 to 5 V, 0 to 10 V, -10 to 10 V, 4 to 20 mA Resolution: 1/4000 (available to set to 1/8000) Conversion speed: 1 ms/point (available to set to 500 μs/point max.) Accuracy (ambient temperature: 25°C): Voltage: ±0.3% of F.S. Current: ±0.3% of F.S.					
	CJ-series CPU Bus Units	Analog Input Unit (High-speed type)	Number of inputs: 4 Signal range (Resolution): ±10 V (Resolution 1/60000) 0 to 5 V, 0 to 10 V (Resolution 1/30000) 1 to 5 V, 4 to 20 mA (Resolution 1/24000) Conversion speed: 80 μs/2 points, 160 μs/4 points Accuracy (ambient temperature: 25°C): ±0.05% of F.S.	0.65	-	CJ1W-ADG41	UC1, CE (See note 4.)
		DeviceNet Unit	Slave functions only, 32,000 points max. Communications type: Remote I/O communications slave (with fixed or user-set allocation)	0.29	-	CJ1W-DRM21	UC1, CE, N, L
		Position Control Unit with MECHATROLINK-II communications	Issues the control commands using the MECHATROLINK-II synchronous communications 16 axes max. Direct operation with ladder program Control mode: Position control/Speed control/Torque control	0.36	-	CJ1W-NCF71	UC1, CE
High-speed Data Collection Unit	PC card slot: CF card Type I/II × 1 slot Mount OMRON memory card HMC-EF□□□□ to use Ethernet (LAN) port: 1 port (10/100BASE-TX) Automatically collects the specified data through the CJ bus at intervals of a few ms, or write the event	0.56	-	CJ1W-SPU01-V2	UC1, CE		
(14)	CJ-series I/O Interface Unit	One unit required on the CJ-series Expansion Rack to connect CJ-series Expansion Rack.	0.13	-	CJ1W-II101	UC1, CE, N, L	
(15)	CJ-series I/O Connecting Cables	Connects I/O Control Module on FQM1 Rack to I/O Interface Unit on CJ-series Expansion Rack		-	CS1W-CN313 CS1W-CN713 CS1W-CN223 CS1W-CN323 CS1W-CN523 CS1W-CN133 CS1W-CN133-B2	N, L, CE	
(16)	CJ-series Power Supply Units	100 to 240 VAC, output capacity: 2.8 A at 5 VDC, 0.4 A at 24 VDC Total power consumption: 14 W	-	-	CJ1W-PA202	UC1, N, L, CE	
		100 to 240 VAC (with RUN output), output capacity: 5 A at 5 VDC, 0.8 A at 24 VDC Total power consumption: 25 W			CJ1W-PA205R		
		100 to 240 VAC, replacement time notification function, no RUN output, output capacity: 5 A at 5 VDC, 0.8 A at 24 VDC Total power consumption: 25 W			CJ1W-PA205C		
		24 VDC, output capacity: 5 A at 5 VDC, 0.8 A at 24 VDC Total power consumption: 25 W			CJ1W-PD025		
		24 VDC, output capacity: 2 A at 5 VDC, 0.4 A at 24 VDC Total power consumption: 19.6 W			CJ1W-PD022		UC1, CE

- Note: 1.** Connectors are not included with the Unit.
Either separately purchase an applicable 40-pole connector, or use an OMRON Connector Terminal Block Conversion Unit (XW2□ series) or I/O Relay Terminal (G7□ series).
- 2.** Connectors are not included with the Unit.
Either separately purchase an applicable 20- or 24-pole connector, or use an OMRON Connector Terminal Block Conversion Unit (XW2□ series) or I/O Relay Terminal (G7□ series).
- 3.** Externally supplied power, not internally consumed current.
- 4.** Approved products are scheduled for shipment in August 2007.

International Standards

- The standards indicated in the "Standards" column are those current for UL, CSA, cULus, NK, and Lloyd standards and EC Directives as of the end of February 2008. The standards are abbreviated as follows: U: UL, U1: UL (Class I Division 2 Products for Hazardous Locations), C: CSA, US: cULus, UC1: cULus (Class I Division 2 Products for Hazardous Locations), CU: cUL, N: NK, L: Lloyd, and CE: EC Directives.
- Ask your OMRON representatives for the conditions under which the standards were met.

FQM1 Series

Specifications

General Specifications

Item	Specifications
Insulation resistance	20 M Ω min. between AC external terminals and GR terminal at 500 VDC, see note 1.)
Dielectric strength	2,300 VAC, 50/60 Hz between AC external terminals and GR terminal for 1 min, leakage current: 10 mA max. (See notes 1 and 3.)
	720 VAC, 50/60 Hz between DC external terminals and GR terminal for 1 min, leakage current: 10 mA max. (See note 1.)
Noise immunity	Conforms to IEC61000-4-4, 2 kV (power line)
Vibration resistance	Conforms to JIS C0040 Amplitude: 0.075 mm (10 to 57 Hz), Acceleration: 9.8 m/s ² (57 to 150 Hz) for 80 min in X, Y, and Z directions (10 sweeps of 8 min = 80 min total)
Shock resistance	Conforms to JIS C0041 147 m/s ² 3 times each in X, Y, and Z directions
Ambient operating temperature	0 to 55°C
Ambient operating humidity	10% to 90% (with no condensation)
Atmosphere	No corrosive gases
Ambient storage temperature	-20 to 75°C
Ground	Less than 100 Ω
Structure	For installation in a control panel
Dimensions (mm)	49 × 90 × 80 mm (W × H × D) excluding cable
Weight	5 kg max. per Module
Safety standards	EC, C-Tick, UL approval pending (See note 4.)

- Note: 1.** Disconnect the LG terminal on the Power Supply Unit from the GR terminal before performing insulation resistance or dielectric testing. Internal components may be destroyed if testing is performed with the LR and GR terminals connected.
- 2.** Values for AC power are at room temperature and a cold start. Values for DC power are for a cold start. A thermistor is used in the inrush current control circuit of the AC power supply to control current at low temperatures. The inrush current may exceed the value given above (by up to twice the given value) when starting at high temperatures or if a hot start is performed immediately after the current is turned OFF for a short period of time because the thermistor element will not be sufficiently cooled. When selecting a fuse or breaker for the external circuit, consider the fusing/detection characteristics and provide a sufficient margin in performance. A capacitor-charged delay circuit is used for the inrush current control circuit in the DC power supply. If hot starts are performed after turning OFF the power supply for only short periods of time, the inrush current may exceed the value given above (by up to twice the given value) because the capacitor will not be discharged.
- 3.** Do not apply voltages exceeding 600 V when performing dielectric testing for the analog I/O terminals. Internal elements may deteriorate.
- 4.** UL-approved products are scheduled for shipment in March 2006.

Performance

Item		Specifications					
		Coordinator Module	Motion Control Module				
Control method		Stored program method	Stored program method				
I/O control method		Cyclic scan method	Cyclic scan method				
Programming language		Ladder diagram method	Ladder diagram method				
Instruction length		1 to 7 steps/instruction	1 to 7 steps/instruction				
Number of instructions		Approx. 300	Approx. 300				
Executing speed	Basic instructions	0.1 μs min.	0.1 μs min.				
	Special instructions	0.3 μs min.	0.3 μs min.				
Common processing time (overhead)		Synchronous mode: 390 μs (when 1 Motion Control Module is connected) Asynchronous mode: 180 μs	<table border="0"> <tr> <td>FQM1-MMP22</td> <td>Synchronous mode: 250 μs Asynchronous mode: 190 μs</td> </tr> <tr> <td>FQM1-MMA22</td> <td>Synchronous mode: 340 μs Asynchronous mode: 280 μs Analog outputs disabled and immediate analog inputs: 190 μs Analog input END: 230 μs</td> </tr> </table>	FQM1-MMP22	Synchronous mode: 250 μs Asynchronous mode: 190 μs	FQM1-MMA22	Synchronous mode: 340 μs Asynchronous mode: 280 μs Analog outputs disabled and immediate analog inputs: 190 μs Analog input END: 230 μs
FQM1-MMP22	Synchronous mode: 250 μs Asynchronous mode: 190 μs						
FQM1-MMA22	Synchronous mode: 340 μs Asynchronous mode: 280 μs Analog outputs disabled and immediate analog inputs: 190 μs Analog input END: 230 μs						
Program capacity	Ladder	10 Ksteps	10 Ksteps				
	Comment storage	Yes	Yes				
Number of tasks		Cyclic tasks: 1, Interrupt tasks: 50	Cyclic tasks: 1, Interrupt tasks: 50				
Subroutines		256	256				
JMP instruction		256	256				
Number of basic I/O points		24	20 per Module				
CIO Area	Built-in Input Bits	16 bits (1 word): CIO 2960.00 to CIO 2960.15	12 bits (1 word): CIO 2960.00 to CIO 2960.11				
	Built-in Output Bits	8 bits (1 word): CIO 2961.00 to CIO 2961.07	8 bits (1 word): CIO 2961.00 to CIO 2961.07				
	I/O bits	320 bits (20 words): CIO 0000 to CIO 0019	None				
	CPU Bus Unit Area	6,400 bits (400 words): CIO 1500 to CIO 1899	None				
	Special I/O Unit Area	13,760 bits (860 words): CIO 2100 to CIO 2959	None				
	Cyclic Refresh Bit Area	640 bits (40 words): CIO 4000 to CIO 4039 Refresh with Motion Module # 1: CIO 4000 to CIO 4009 Refresh with Motion Module # 1: CIO 4010 to CIO 4019 Refresh with Motion Module # 1: CIO 4020 to CIO 4029 Refresh with Motion Module # 1: CIO 4030 to CIO 4039	160 bits (10 words): CIO 4000 to CIO 4009 Input refresh from Coordinator Module to Motion Control Module: CIO 4000 to CIO 4004 Output refresh from Motion Control Module to Coordinator Module: CIO 4005 to CIO 4009				
	Sync Data Link Bit Area	320 bits (20 words): CIO 1200 to CIO 1219 Transmission refresh from Coordinator Module: CIO 1200 to CIO 1203 Transmission refresh from Motion Module # 1: CIO 1204 to CIO 1207 Transmission refresh from Motion Module # 2: CIO 1208 to CIO 1211 Transmission refresh from Motion Module # 3: CIO 1212 to CIO 1215 Transmission refresh from Motion Module # 4: CIO 1216 to CIO 1219	320 bits (20 words): CIO 1200 to CIO 1219 Transmission refresh from Coordinator Module: CIO 1200 to CIO 1203 Transmission refresh from Motion Module # 1: CIO 1204 to CIO 1207 Transmission refresh from Motion Module # 2: CIO 1208 to CIO 1211 Transmission refresh from Motion Module # 3: CIO 1212 to CIO 1215 Transmission refresh from Motion Module # 4: CIO 1216 to CIO 1219				
	Serial PLC Link Bit Area (complete link method)	1,440 bits (90 words) CIO 3100 to CIO 3189 CIO 3100 to CIO 3189: CJ1M to FQM1 CIO 3100 to CIO 3189: FQM1 to CJ1M and sources other than FQM1 (10 words each according to unit number)	None				
	Serial PLC Link Bit Area (master link method)	320 bits (20 words): CIO 3100 to CIO 3119 CIO 3100 to CIO 3109: CJ1M to FQM1 CIO 3110 to CIO 3119: FQM1 to CJ1M Connectable to the host PLC (CJ1M) as a Serial PLC Link slave.	None				
	DeviceNet Link Bit Area	9,600 bits (600 words): CIO 3200 to CIO 3799	None				
Internal Auxiliary Area	CIO Area	49,792 bits: CIO 0020 to CIO 1199, CIO 1220 to CIO 1499, CIO 1900 to CIO 2099, CIO 2962 to CIO 3099, CIO 3190 to CIO 3199, CIO 3800 to CIO 3999, CIO 4040 to CIO 4999, CIO 6000 to CIO 6143	81,792 bits: CIO 0000 to CIO 1199, CIO 1220 to CIO 2959, CIO 2962 to CIO 3999, CIO 4010 to CIO 4999, CIO 6000 to CIO 6143				
	Work Area	4,096 bits: W000 to W255	4,096 bits: W000 to W255				

FQM1 Series

Item		Specifications			
		Coordinator Module	Motion Control Module		
Auxiliary Area	READ/WRITE	Read-only: 7,168 bits (A000 to A447) Read/Write: 8,192 bits (A448 to A959)	Read-only: 7,168 bits (A000 to A447) Read/Write: 8,192 bits (A448 to A959)		
	Error log	100 words: A100 to A199 (20 records)	100 words: A100 to A199 (20 records)		
TR Area		16 bits: TR0 to TR15	16 bits: TR0 to TR15		
Timer Area		256 timers: T0000 to T0255 (1-ms timers, 10-ms timers, 100-ms timers)	256 timers: T0000 to T0255 (1-ms timers, 10-ms timers, 100-ms timers)		
Counter Area		256 counters: C0000 to C0255 (decrementing counters, reversible counters) Note: Not retained on power interruption.	256 counters: C0000 to C0255 (decrementing counters, reversible counters) Note: Not retained on power interruption.		
DM Area	Read/Write (not retained)	20,000 words: D00000 to D19999 (Not retained on power interruption.)	30,000 words: D00000 to D29999 (Not retained on power interruption.) (See note 1.)		
	Read/Write (retained)	12,768 words: D20000 to D32767 (Saved in flash memory. Not saved when written by ladder program, however, saved in flash memory if written by Programming Device such as the CX-Programmer.)	2,768 words: D30000 to D32767 (backed up by super capacitor)		
System Setup		System Setup Area (shared by Coordinator Module, Motion Control Modules, and peripheral services), Peripheral Service Settings	System Setup Area (shared by Coordinator Module and Motion Control Modules), Motion Parameter Settings		
Function block address allocation area	CIO Area	16,000 bits (1,000 words): CIO 5000 to CIO 5999	16,000 bits (1,000 words): CIO 5000 to CIO 5999		
	Timer Area	100 bits: T0206 to T0255	100 bits: T0206 to T0255		
	Counter Area	100 bits: C0206 to C0255	100 bits: C0206 to C0255		
Index Registers		IR0 to IR15 (IR0 and IR1 used with the JSB instruction) Note: IR16 to IR 63 for FB/ST (used by the system)	IR0 to IR15 (IR0 and IR1 used with the JSB instruction) Note: IR16 to IR 63 for FB/ST (used by the system)		
Data Registers		DR0 to DR15 Note: IR16 to IR 63 for FB/ST (used by the system)	DR0 to DR15 Note: IR16 to IR 63 for FB/ST (used by the system)		
Interrupts	Input interrupts	None	4 inputs (with countdown mode)		
	Timer interrupts	1 (scheduled or one-shot interrupts)	1 (scheduled or one-shot interrupts)		
Power OFF backup function (momentary power interruptions)		Super capacitor	Super capacitor		
Memory backup	Super capacitor backup	Error log	Error log, a portion of DM (for momentary interruptions)		
	Flash memory	User programs, System Setup, part of DM	User programs, System Setup		
Trace Memory		4,000 words	4,000 words		
Peripheral services		Peripheral port (CX-Programmer connection only), RS-232C port (Host Link, no-protocol, NT Link, Serial PLC Link (slave)), RS-422A (servo driver connection) services	Event requests from the Coordinator Module		
Self-diagnosis		CPU error (WDT), memory error	CPU error (WDT), memory error		
Program check functions		Checked using Programming Device	Checked using Programming Device		
Super capacitor life		Approx. 100 hours (ambient temperature: 25°C, see note 2.)	Approx. 100 hours (ambient temperature: 25°C, see note 2.)		
Clock		None	None		
Power interruption detection time		AC: 10 to 25 ms (not fixed)	-		
Power interruption detection delay		0 to 10 ms	-		
RUN output		Yes (When using CJ1W-PA205R)	-		
Individual functions		Serial communications	Peripheral port (toolbus, Host Link)	High-speed counters	Single phase, up-down counting, pulse plus direction input (50 kHz/1 MHz), differential phase inputs (50/500 kHz, with phase difference multiplier of 4: 2 MHz)
			Coordinator Module built-in RS-232C port (Host Link, no-protocol, NT Link, Serial PC Link (slave))	High-speed pulse outputs	CW/CCW (1 MHz: line-driver) one-shot pulse output
			Coordinator Module built-in RS-422A port (servo driver interface, serial gateway, no-protocol)	Analog inputs	Conversion speed: 40 μs/point Resolution: -10 to 10 V: 16,000 0 to 10 V: 8,000 0 to 5 V: 4,000 1 to 5 V: 4,000 4 to 20 mA: 4,000
				Analog outputs	Conversion speed: 40 μs/point Resolution: -10 to 10 V: 10,000 0 to 10 V, 0 to 5 V, or 1 to 5 V: 4,000

Note: 1. Can also be retained in flash memory. A bit can be manipulated to automatically restore the data according to a parameter setting in the System Setup when the power supply is turned ON.
2. Depends on the ambient temperature and number of years in use.

Coordinator Module

Built-in General-purpose I/O

Item		Specifications
Input specifications	Inputs	16
	Input voltage	20.4 to 26.4 V
	Input voltage	Normal inputs (16): ON response: 100 μ s, OFF response: 1 ms max. 8 inputs/common
Output specifications	Outputs	8
	Output form	NPN transistors
	Switching capacity	4.5 to 30 VDC, 0.3 A per transistor
	ON response time	0.1 ms max.
	OFF response time	1 ms max.

Motion Control Module

Built-in General-purpose I/O

Item		Specifications	
Input specifications	Inputs	12	
	Input voltage	20.4 to 26.4 V	
	Input voltage	Interrupt inputs (4)	ON response: 30 μ s max. OFF response: 0.2 ms max.
		Normal inputs (8)	ON response: 100 μ s max. OFF response: 1 ms max.
Output specifications	Outputs	8	
	Output form	NPN transistors	
	Switching capacity	4.5 to 30 VDC, 0.3 A per transistor	
	Output response	ON response: 0.1 ms max. OFF response: 1 ms max.	

Motion Control Module

Motion Control Module with Pulse I/O (FQM1-MMP22)

Item		Description
I/O	Pulse I/O	Pulse inputs: 2 (for servo with absolute encoder) Pulse outputs: 2 One-shot pulse outputs: 2
	General-purpose I/O	General-purpose inputs: 12 General-purpose outputs: 8
Functions	Pulse outputs	The following operations are possible. <ul style="list-style-type: none"> • Speed control (fixed speed, acceleration, and deceleration) • Position control (fixed-speed positioning, trapezoidal positioning, deceleration positioning) • Speed control based on present position (pulse output target value comparison or range comparison) • Electronic cam operation (positioning according to position of real or virtual axis) • One-shot pulse outputs (turning ON an output for a specified time, minimum unit: 0.01 ms) • Timing using pulse counter (minimum unit: 0.001 ms)
	Pulse inputs	<ul style="list-style-type: none"> • High-speed counters: Single phase, up-down counting, pulse plus direction input (50 kHz/1 MHz), differential phase inputs (50/500 kHz, with multiplier of 4: 2 MHz) • Starting/stopping high-speed counters with Counter Start Bit • Measuring change in high-speed counter present value • Measuring high-speed counter frequency

Motion Control Module with Analog I/O (FQM1-MMA22)

Item		Description
General-purpose I/O	Pulse inputs	Pulse inputs: 2 (for servo with absolute encoder)
	Analog I/O	<ul style="list-style-type: none"> • Analog inputs: 1 (-10 to 10 V, 0 to 10 V, 0 to 5 V, 1 to 5 V, and 4 to 20 mA), Conversion speed: 40 μs/point • Analog outputs: 2 (-10 to 10 V, 0 to 10 V, 0 to 5 V, and 1 to 5 V), Conversion speed: 40 μs/point
	General-purpose I/O	General-purpose inputs: 12 General-purpose outputs: 8
Functions	Analog outputs	<ul style="list-style-type: none"> • Slope function • Output hold function • Offset gain adjustment
	Analog inputs	<ul style="list-style-type: none"> • Offset gain adjustment • High-speed analog sampling

FQM1 Series

List of Support Functions Depending on the Unit Version

O: Supported, -: Not supported

Module type Model Unit version Descriptions	Coordinator Module		Motion Control Module	
	FQM1-CM002		FQM1-MMP22/MMA22	
	Ver. 3.2 or higher	Ver. 3.3 or higher	Ver. 3.2 or higher	Ver. 3.3 or higher
Compatible with OMUNC G-series Servo ABS	-	-	-	O
Addition of compatible CJ-series Units • Analog input • Analog I/O • Analog output	-	O	-	-
Addition of compatible CJ-series Units CJ1W-NC□□3/ CJ1W-V600C1□	O	O	-	-
Addition of expanded cyclic refresh area	O	O	-	-
Expansion with AXIS instruction function	O	O	O	O
Expansion with PULS instruction (electronic cam mode) function	-	-	O *1	O *1
Compatible with 1 Hz pulse output	-	-	O *1	O *1
Interrupt task startup when a counter is reset	-	-	O	O
Compatible with high-speed analog sampling multiple settings	-	-	O *2	O *2

*1. Only available with FQM1-MMP22.

*2. Only available with FQM1-MMA22.

Types of the Unit Version

Name	Model	Unit Ver.
Coordinator Module	FQM1-CM002	Unit Ver. 3.3 Unit Ver. 3.2 Unit Ver. 3.1 Unit Ver. 3.0
Motion Control Module	FQM1-MMP22 FQM1-MMA22	Unit Ver. 3.3 Unit Ver. 3.2 Unit Ver. 3.1 Unit Ver. 3.0

Relations between the Unit Version and Support Software

	Functions to be used *1		Support Software required CX-Programmer			
			Ver. 3.3	Ver. 4.0	Ver. 5.0/ Ver. 6.0	Ver. 7.0 or higher
Unit Ver. 3.3	Functions enhanced in Unit Ver. 3.3	to be used	×	×	×	O *2
		not to be used	O	O	O	O
Unit Ver. 3.2	Functions enhanced in Unit Ver. 3.2	to be used	×	×	O	O
		not to be used	O	O	O	O

*1. When the functions enhanced in version upgrade are not used, the CX-Programmer version does not need to be upgraded.

*2. To perform the OMUNC G-series Servo ABS settings from the system setup menu, use the CX-Programmer Ver. 7.1 or higher.

Dimensions

Coordinator Module
FQM1-CM002

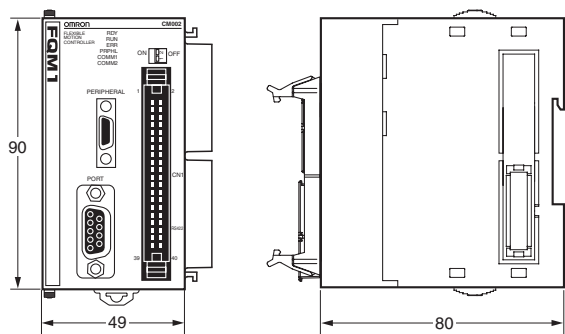

Power Supply Units
CJ1W-PA202

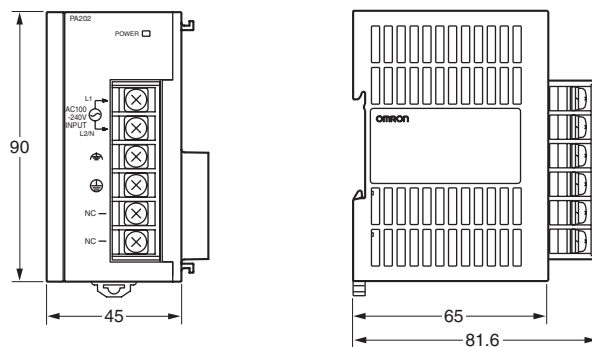

Motion Control Modules
FQM1-MMP22/MMA22

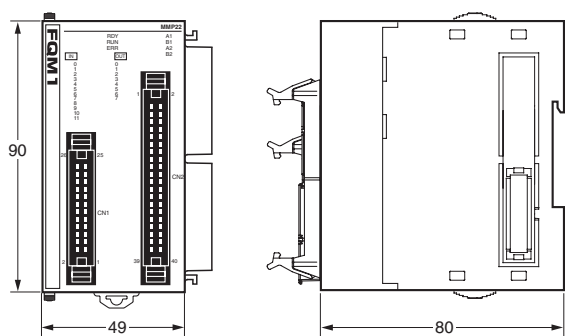

Power Supply Units
CJ1W-PA205R

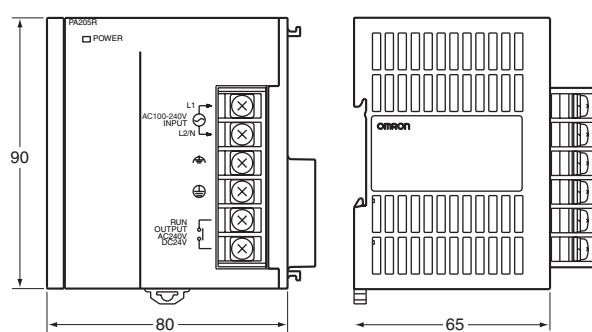

End Module
FQM1-TER01

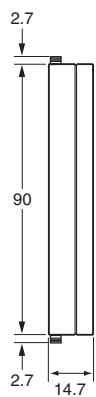

I/O Control Module
FQM1-IC101

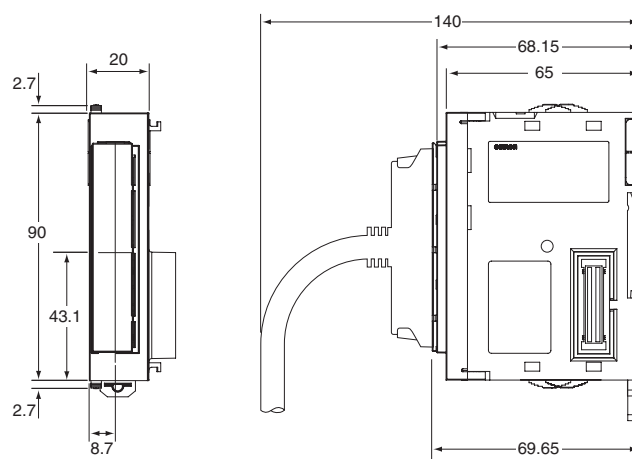

FQM1 Series

Assembled Dimensions

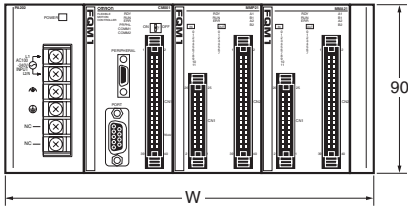

$W = a + 49 + 49 \times n + 14.7$
 a: Width of Power Supply Unit
 n: Number of Motion Control Modules connected (4 max.)

FQM1 Expanded Using CJ-series Units

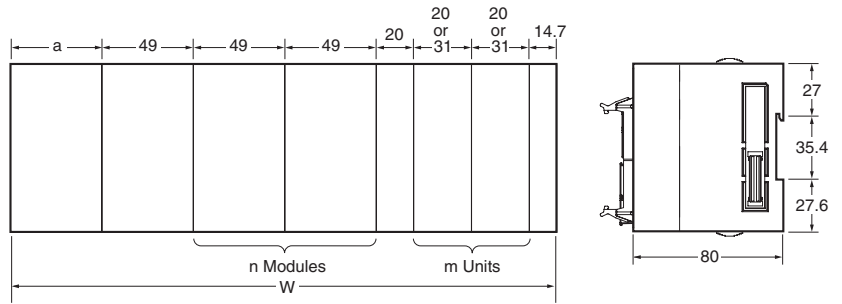

$W = a + 49 + 49 \times n + (20 \text{ or } 31) \times m + 14.7$
 a: Width of Power Supply Unit
 n: Number of Motion Control Modules connected (4 max.)
 m: Number of CJ-series connected

The maximum value of m + n is 10, as long as the current consumption limit is not exceeded.

Height with Cables Connected

Height with Peripheral Port and RS-232C Port Connected

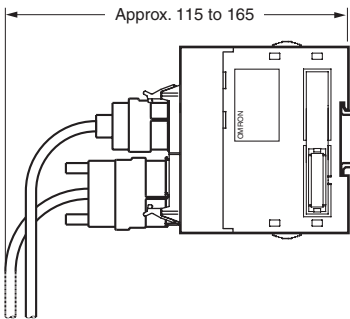

Servo Relay Unit

XW2B-80J7-1A

XW2B-80J7-12A

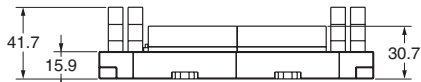
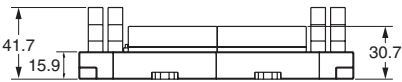
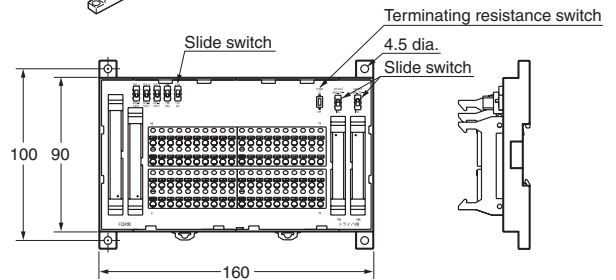
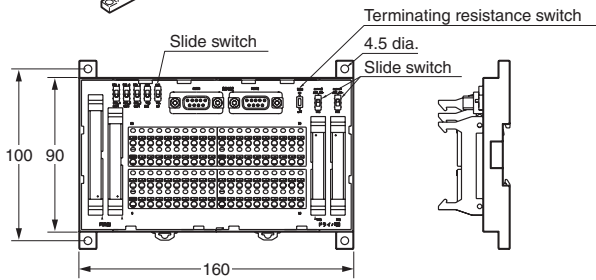
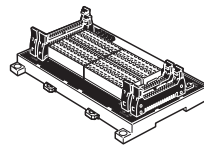
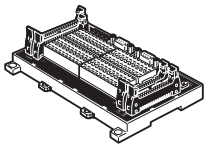

Related Manuals

Man.No.		Model	Manual Title
English	Japanese		
O012	SBCE-338	FQM1-CM002/MMP22/MMA22	FQM1 Series Flexible Motion Controllers User's Manual
O013	SBCE-339	FQM1-CM002/MMP22/MMA22	FQM1 Series Flexible Motion Controllers Command Reference Manual