

## HF/VHF/UHF RF power N-channel MOSFETs

### Features

- Gold metallization
- Excellent thermal stability
- Common source push-pull configuration
- $P_{OUT} = 350\text{ W}$  min. with 21 dB gain @ 175 MHz
- In compliance with the 2002/95/EC European directive

### Description

The STAC2942F is a gold metallized N-channel MOS field-effect RF power transistor. It is intended for use in 50 V DC large signal applications up to 250 MHz.

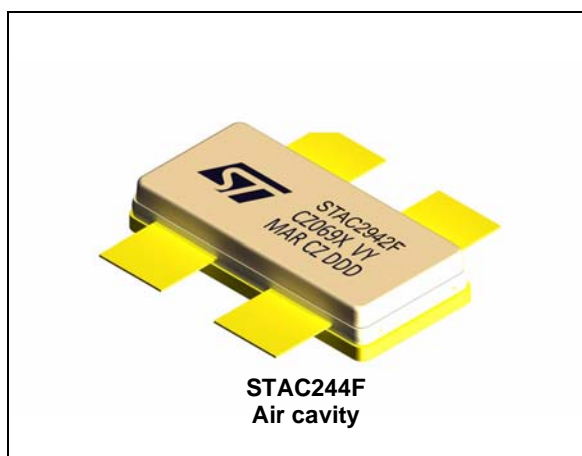

Figure 1. Pin connection

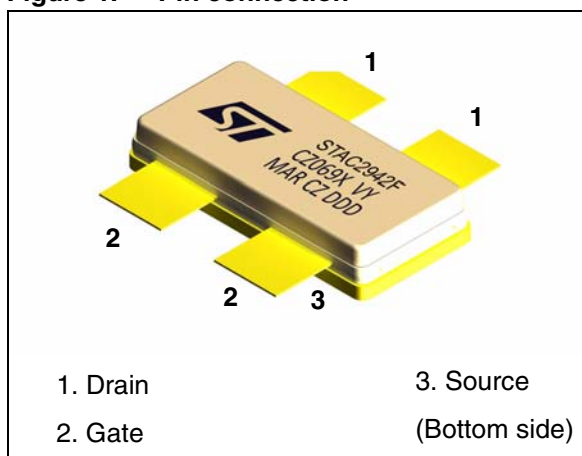

Table 1. Device summary

Order code	Marking	Package	Packaging
STAC2942FW	STAC2942F <sup>(1)</sup>	STAC244F	Plastic tray

1. For more details please refer to [Chapter 7: Marking, packing and shipping specifications](#).

# Contents

<b>1</b>	<b>Electrical data</b> .....	<b>3</b>
1.1	Maximum ratings .....	3
1.2	Thermal data .....	3
<b>2</b>	<b>Electrical characteristics</b> .....	<b>4</b>
2.1	Static .....	4
2.2	Dynamic .....	4
<b>3</b>	<b>Impedance</b> .....	<b>5</b>
<b>4</b>	<b>Typical performance</b> .....	<b>6</b>
<b>5</b>	<b>Test circuit</b> .....	<b>10</b>
<b>6</b>	<b>Package mechanical data</b> .....	<b>12</b>
<b>7</b>	<b>Marking, packing and shipping specifications</b> .....	<b>14</b>
<b>8</b>	<b>Revision history</b> .....	<b>15</b>

# 1 Electrical data

## 1.1 Maximum ratings

**Table 2. Absolute maximum ratings** ( $T_{CASE} = 25\text{ °C}$ )

Symbol	Parameter	Value	Unit
$V_{(BR)DSS}^{(1)}$	Drain source voltage	130	V
$V_{DGR}^{(1)}$	Drain-gate voltage ( $R_{GS} = 1\text{ M}\Omega$ )	130	V
$V_{GS}$	Gate-source voltage	$\pm 20$	V
$I_D$	Drain current	40	A
$P_{DISS}$	Power dissipation	625	W
$T_J$	Max. operating junction temperature	200	$^{\circ}\text{C}$
$T_{STG}$	Storage temperature	-65 to +150	$^{\circ}\text{C}$

1.  $T_J = 150\text{ °C}$

## 1.2 Thermal data

**Table 3. Thermal data**

Symbol	Parameter	Value	Unit
$R_{thJC}$	Junction - case thermal resistance	0.28	$^{\circ}\text{C/W}$

## 2 Electrical characteristics

( $T_{CASE} = 25\text{ °C}$ )

### 2.1 Static

**Table 4. Static (per side)**

Symbol	Test conditions			Min.	Typ.	Max.	Unit
$V_{(BR)DSS}^{(1)}$	$V_{GS} = 0\text{ V}$	$I_{DS} = 100\text{ mA}$		130			V
$I_{DSS}$	$V_{GS} = 0\text{ V}$	$V_{DS} = 50\text{ V}$				100	$\mu\text{A}$
$I_{GSS}$	$V_{GS} = 20\text{ V}$	$V_{DS} = 0\text{ V}$				250	nA
$V_{GS(Q)}$	$V_{DS} = 10\text{ V}$	$I_D = 250\text{ mA}$		1.5	2.5	4.0	V
$V_{DS(ON)}$	$V_{GS} = 10\text{ V}$	$I_D = 10\text{ A}$				3.0	V
$G_{FS}$	$V_{DS} = 10\text{ V}$	$I_D = 5\text{ A}$		5			S
$C_{ISS}$	$V_{GS} = 0\text{ V}$ $V_{DS} = 50\text{ V}$ $f = 1\text{ MHz}$				425		pF
$C_{OSS}$					202		pF
$C_{RSS}$					12		pF

1.  $T_J = 150\text{ °C}$

### 2.2 Dynamic

**Table 5. Dynamic**

Symbol	Test conditions	Min.	Typ.	Max.	Unit
$P_{OUT}$	$V_{DD} = 50\text{ V}$ , $I_{DQ} = 2 \times 250\text{ mA}$ , $P_{IN} = 4\text{ W}$ , $f = 175\text{ MHz}$	350	450		W
$h_D$	$V_{DD} = 50\text{ V}$ , $I_{DQ} = 2 \times 250\text{ mA}$ , $P_{IN} = 4\text{ W}$ , $f = 175\text{ MHz}$	60	75		%

### 3 Impedance

Figure 2. Current conventions

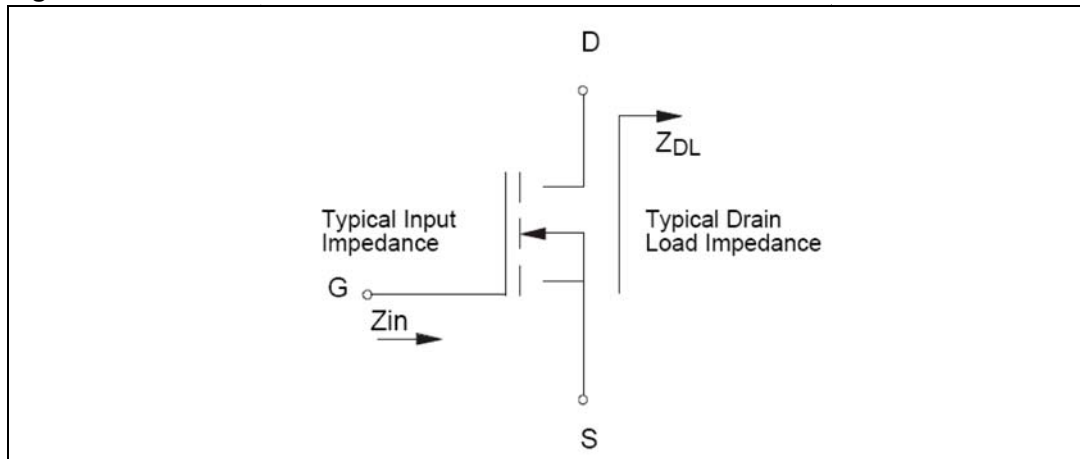

Table 6. Impedance data

Freq. (MHz)	$Z_{IN}$ ( $\Omega$ )	$Z_{DL}$ ( $\Omega$ )
175 MHz	$2.0 - j2.0$	$3.5 + j5.2$

Note: Measured gate to gate and drain to drain, respectively.

# 4 Typical performance

**Figure 3. Capacitances vs drain supply voltage**

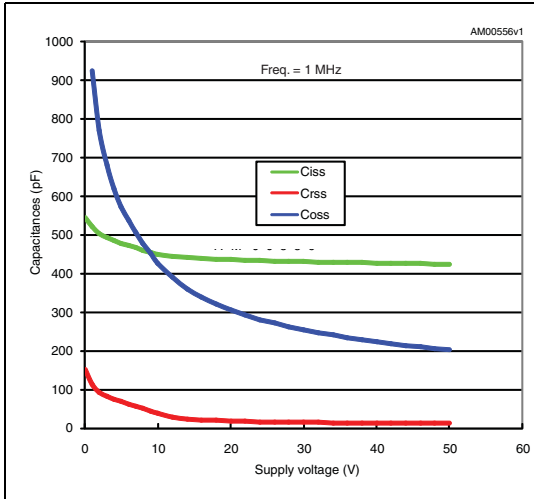

**Figure 4. Output power vs drain supply voltage**

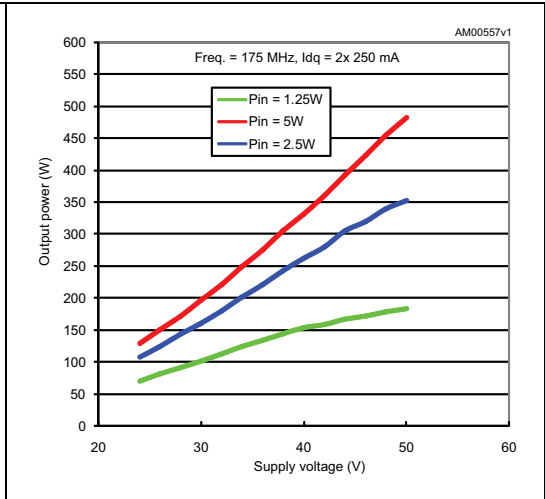

**Figure 5. Output power vs gate voltage**

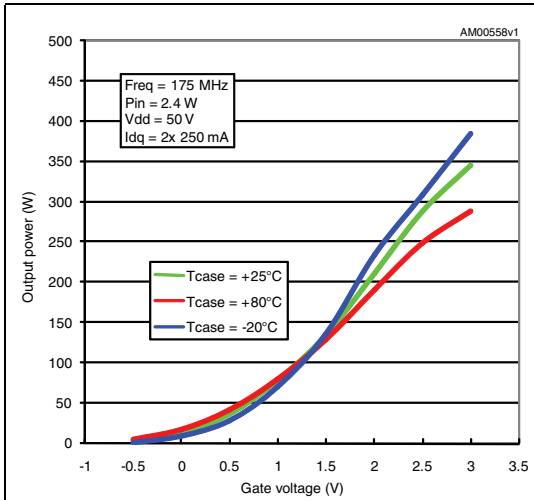

**Figure 6. Output power vs input power**

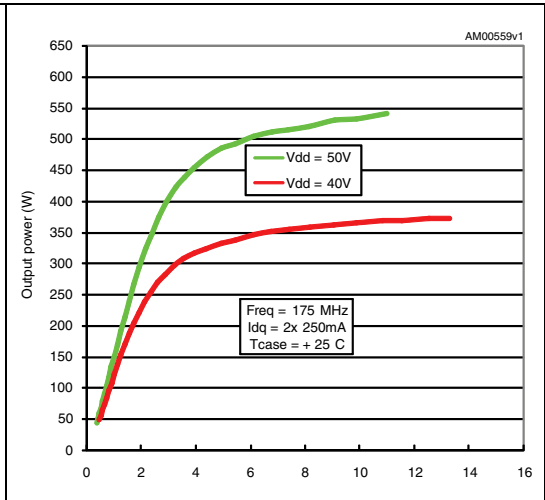

**Figure 7. Output power vs input power and case temperature**

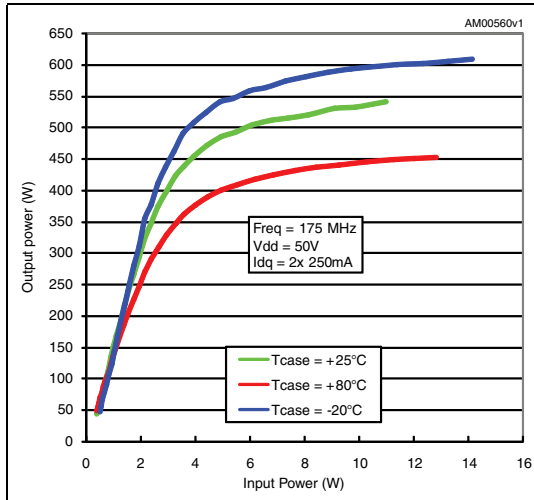

**Figure 8. Efficiency vs output power and case temperature**

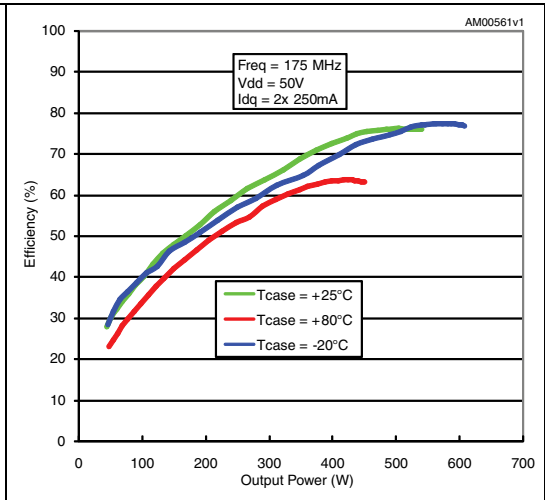

**Figure 9. Power gain vs output power and case temperature**

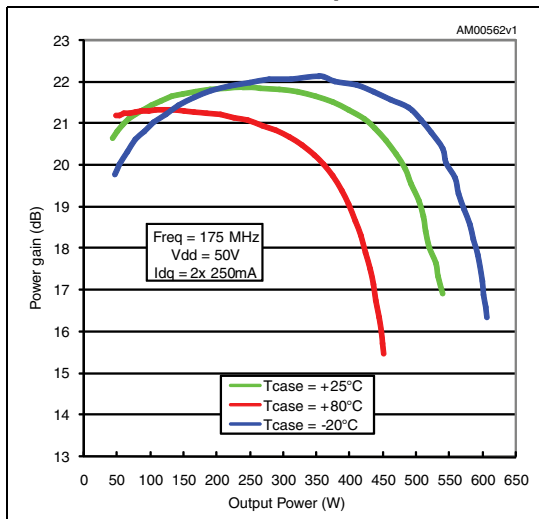

Figure 10. Maximum safe operating area

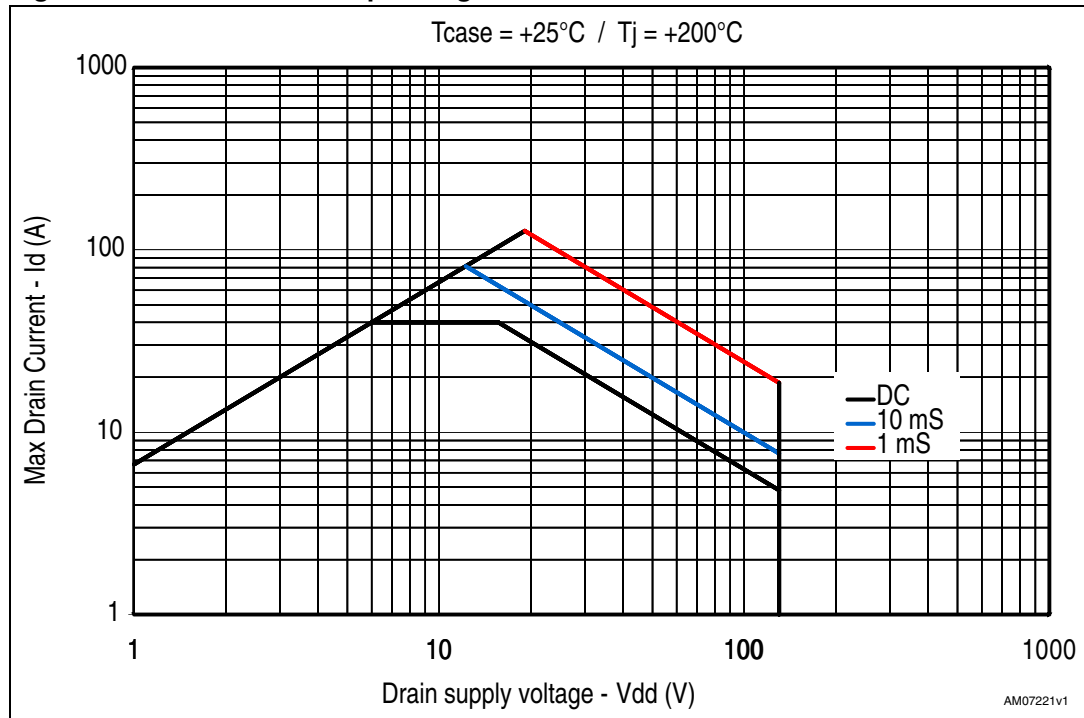

Figure 11. Transient thermal impedance

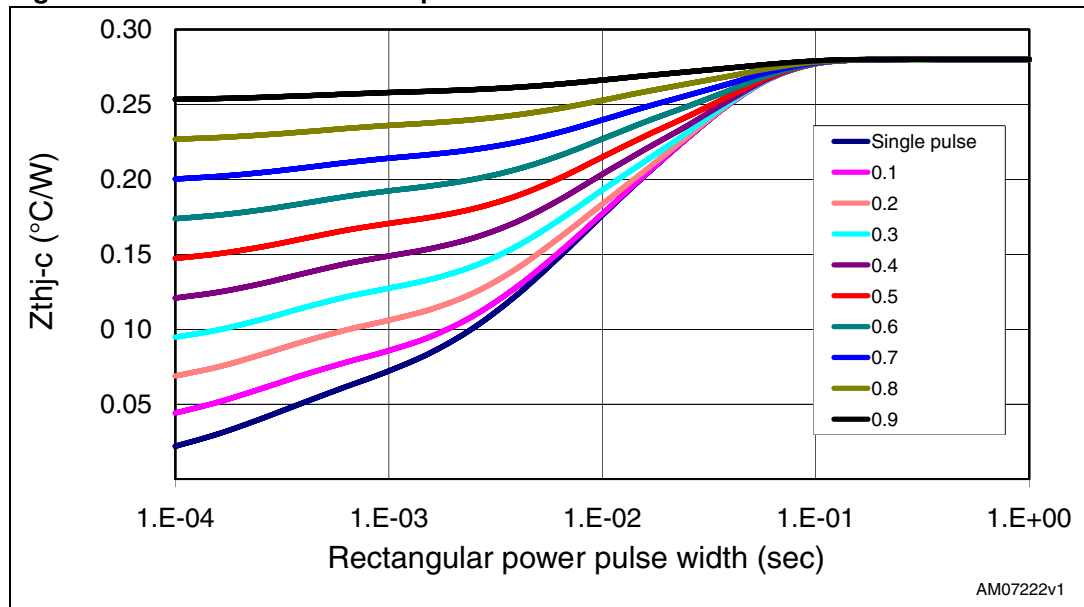
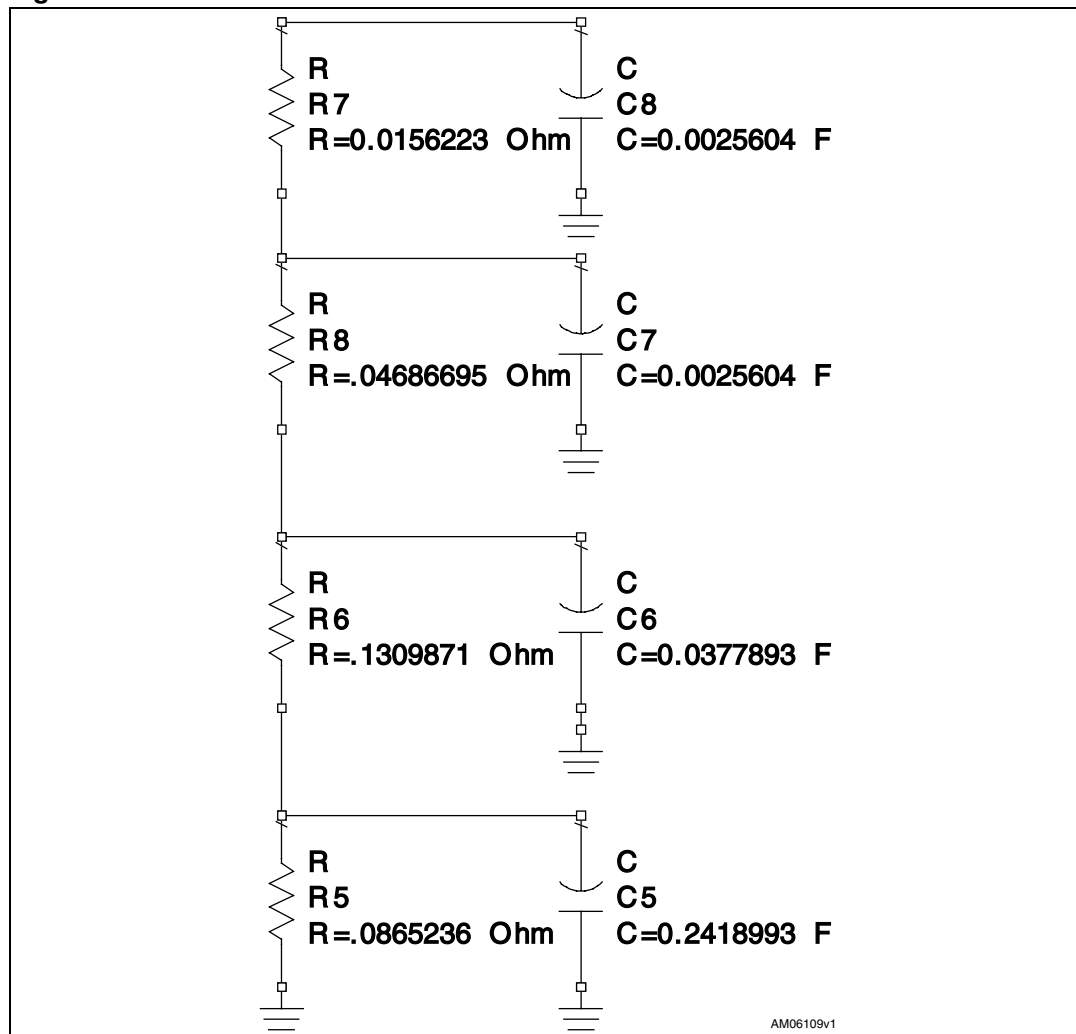



Figure 12. Transient thermal model



# 5 Test circuit

Figure 13. 175 MHz test circuit schematic (production test circuit)

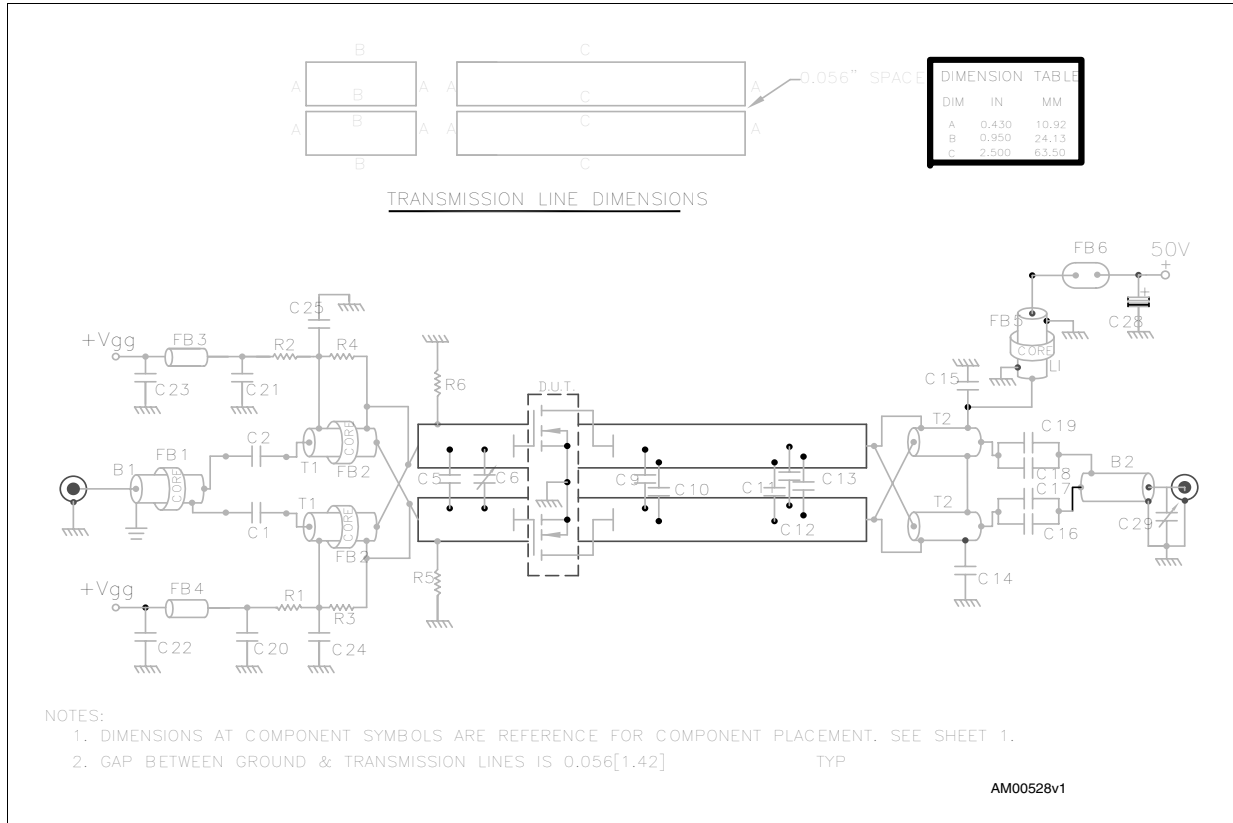

Table 7. 175 MHz test circuit component part list

Component	Description
C1, C2, C14, C15, C24, C25	1200 pF ATC 700B chip capacitor
C5	75 pF ATC 100B chip capacitor
C6	ST406 variable capacitor
C9, C10	47 pF ATC 100B chip capacitor
C11, C12, C13	43 pF ATC 100B chip capacitor
C16, C18	470 pF ATC 100B chip capacitor
C17, C19, C20, C21	10,000 pF ATC 200B chip capacitor
C22, C23	0.1 μF 200 V chip capacitor
C28	10 μF 100 V electrolytic capacitor
C29	0.8 - 8 pF variable capacitor
R1, R2, R5, R6	430 Ω 1/2 W chip resistor

Table 7. 175 MHz test circuit component part list (continued)

Component	Description
R3, R4	270 $\Omega$ 1/2 W axial lead resistor
B1	RG-316 50 $\Omega$ 11.8" thru ferrite toroid
B2	RG-142 50 $\Omega$ 11.8"
T1	4:1, RG-316 25 $\Omega$ , 5.9", 2 turns thru ferrite core
T2	1:4, 25 $\Omega$ semi-rigid cable, OD .141", 5.9"
L1	$\lambda/4$ inductor, RG-142 50 $\Omega$ 11.8", 3 turns thru ferrite toroid
FB1,FB5	Ferrite toroid
FB2, FB6	Multi-aperture core
FB3, FB4	Surface mount ferrite bead
PCB	Rogers ultralam 2000, Er 2.55, .060"

Figure 14. Circuit layout

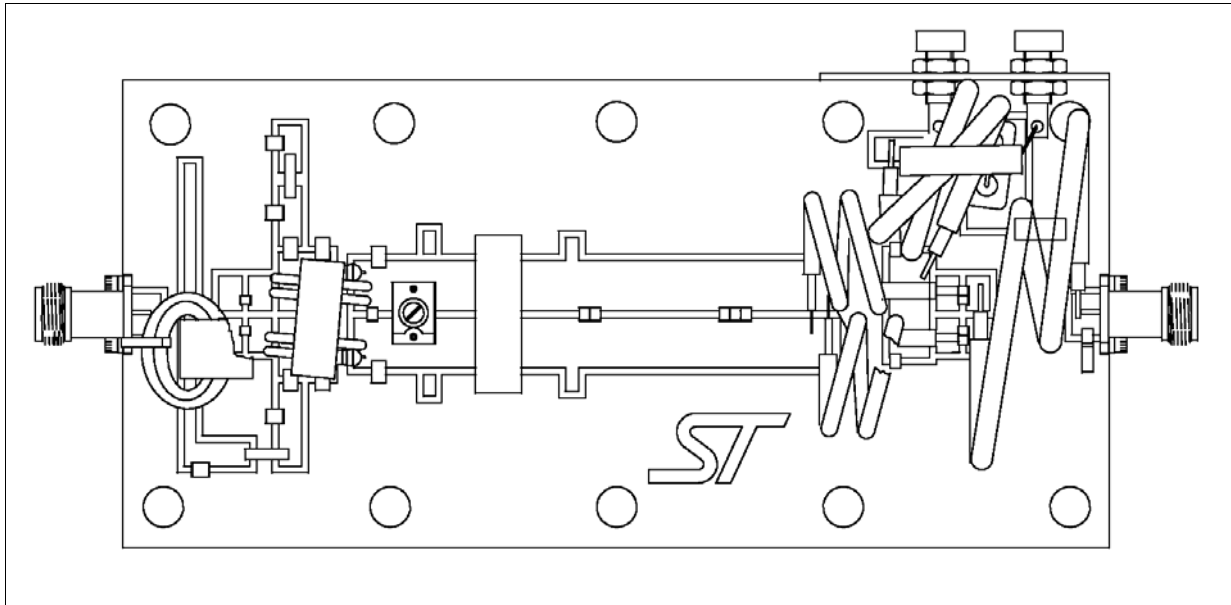

## 6 Package mechanical data

In order to meet environmental requirements, ST offers these devices in different grades of ECOPACK® packages, depending on their level of environmental compliance. ECOPACK® specifications, grade definitions and product status are available at: [www.st.com](http://www.st.com). ECOPACK® is an ST trademark.

**Table 8. STAC244F package dimensions**

Dim.	mm.		Inch	
	Min	Max	Min	Max
A	5.10	5.59	200	220
A1	4.32	4.83	170	190
B	4.32	5.33	170	210
C	9.65	9.91	380	390
D	19.61	20.02	772	788
E	20.45	20.70	805	815
F	0.08	1.15	.003	.006
G	0.89	1.14	.035	.045
H	1.45	1.70	.057	.067
I	3.18	4.32	.125	.170
J	9.27	9.53	.365	.375

Figure 15. Package dimensions

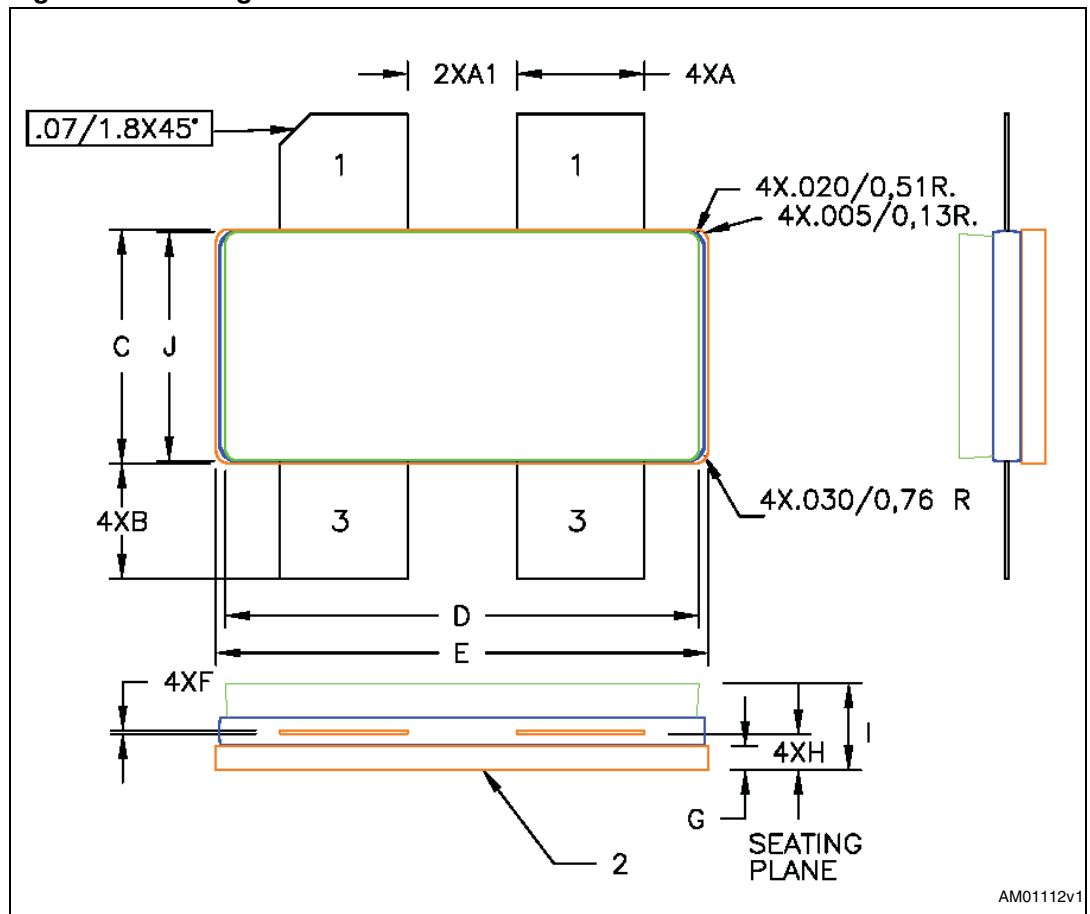

## 7 Marking, packing and shipping specifications

**Table 9. Packing and shipping specifications**

Order code	Packaging	Pcs per tray	Dry pack humidity	Lot code
STAC2942FW	Tube	20	< 10 %	Not mixed

**Figure 16. Marking layout**

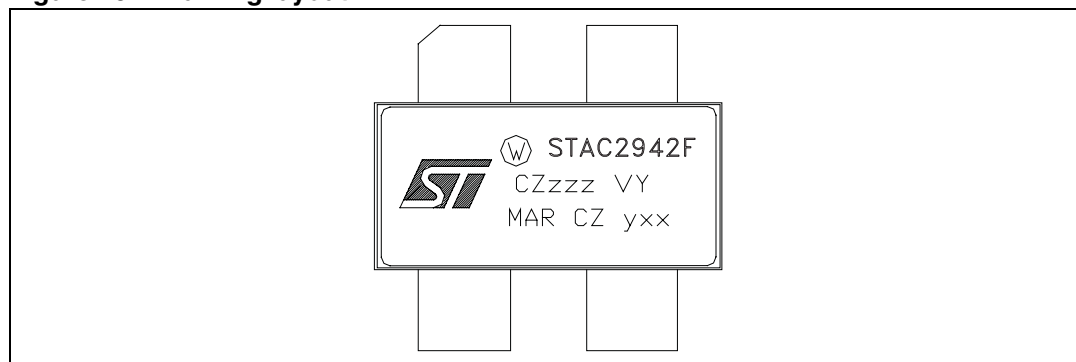

**Table 10. Marking specifications**

Symbol	Description
W	Wafer process code
CZ	Assembly plant
xxx	Last 3 digit of diffusion lot
VY	Diffusion plant
MAR	Country of origin
CZ	Test and finishing plant
y	Assembly year
yy	Assembly week

## 8 Revision history

**Table 11. Document revision history**

Date	Revision	Changes
12-Feb-2010	1	First release.
16-Apr-2010	2	Added <i>Figure 10</i> , <i>Figure 11</i> and <i>Figure 12</i> .
25-Oct-2011	3	Added <i>Chapter 7: Marking, packing and shipping specifications</i> .

**Please Read Carefully:**

Information in this document is provided solely in connection with ST products. STMicroelectronics NV and its subsidiaries ("ST") reserve the right to make changes, corrections, modifications or improvements, to this document, and the products and services described herein at any time, without notice.

All ST products are sold pursuant to ST's terms and conditions of sale.

Purchasers are solely responsible for the choice, selection and use of the ST products and services described herein, and ST assumes no liability whatsoever relating to the choice, selection or use of the ST products and services described herein.

No license, express or implied, by estoppel or otherwise, to any intellectual property rights is granted under this document. If any part of this document refers to any third party products or services it shall not be deemed a license grant by ST for the use of such third party products or services, or any intellectual property contained therein or considered as a warranty covering the use in any manner whatsoever of such third party products or services or any intellectual property contained therein.

**UNLESS OTHERWISE SET FORTH IN ST'S TERMS AND CONDITIONS OF SALE ST DISCLAIMS ANY EXPRESS OR IMPLIED WARRANTY WITH RESPECT TO THE USE AND/OR SALE OF ST PRODUCTS INCLUDING WITHOUT LIMITATION IMPLIED WARRANTIES OF MERCHANTABILITY, FITNESS FOR A PARTICULAR PURPOSE (AND THEIR EQUIVALENTS UNDER THE LAWS OF ANY JURISDICTION), OR INFRINGEMENT OF ANY PATENT, COPYRIGHT OR OTHER INTELLECTUAL PROPERTY RIGHT.**

**UNLESS EXPRESSLY APPROVED IN WRITING BY TWO AUTHORIZED ST REPRESENTATIVES, ST PRODUCTS ARE NOT RECOMMENDED, AUTHORIZED OR WARRANTED FOR USE IN MILITARY, AIR CRAFT, SPACE, LIFE SAVING, OR LIFE SUSTAINING APPLICATIONS, NOR IN PRODUCTS OR SYSTEMS WHERE FAILURE OR MALFUNCTION MAY RESULT IN PERSONAL INJURY, DEATH, OR SEVERE PROPERTY OR ENVIRONMENTAL DAMAGE. ST PRODUCTS WHICH ARE NOT SPECIFIED AS "AUTOMOTIVE GRADE" MAY ONLY BE USED IN AUTOMOTIVE APPLICATIONS AT USER'S OWN RISK.**

Resale of ST products with provisions different from the statements and/or technical features set forth in this document shall immediately void any warranty granted by ST for the ST product or service described herein and shall not create or extend in any manner whatsoever, any liability of ST.

ST and the ST logo are trademarks or registered trademarks of ST in various countries.

Information in this document supersedes and replaces all information previously supplied.

The ST logo is a registered trademark of STMicroelectronics. All other names are the property of their respective owners.

© 2011 STMicroelectronics - All rights reserved

STMicroelectronics group of companies

Australia - Belgium - Brazil - Canada - China - Czech Republic - Finland - France - Germany - Hong Kong - India - Israel - Italy - Japan - Malaysia - Malta - Morocco - Philippines - Singapore - Spain - Sweden - Switzerland - United Kingdom - United States of America

[www.st.com](http://www.st.com)