



### Typical Applications

The HMC320MS8G(E) is ideal for:

- UNII
- HiperLAN

### Features

- Selectable Functionality:  
LNA, Driver, or LO Buffer Amp
- Adjustable Input IP3 Up to +10 dBm
- +3V Operation
- Ultra Small 8 Lead MSOP: 14.8 x 14.8 x 1 mm

### Functional Diagram

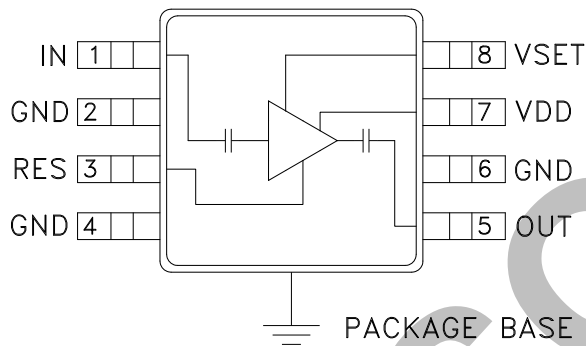

### General Description

The HMC320MS8G & HMC320MS8GE are low cost C-band fixed gain Low Noise Amplifiers (LNA). The HMC320MS8G & HMC320MS8GE operate using a single positive supply that can be set between +3V and +5V. With +3V bias, the LNA provides a noise figure of 2.5 dB, 1 dB gain and better than 10 dB return loss across the UNII band. The HMC320MS8G & HMC320MS8GE also feature an adaptive biasing that allows the user to select the optimal P1dB performance for their system using an external set resistor on the “RES” pin. P1dB performance can be set between a range of +1 dBm to +13 dBm. The low cost LNA uses an 8-leaded MSOP ground base surface mount plastic package, which occupies less than 14.8 mm<sup>2</sup>.

### Electrical Specifications, $T_A = +25^\circ C$ , $V_{dd} = +3V$

Parameter	Low Power* (VSET = 0V, I <sub>dd</sub> = 7 mA)			Medium Power* (VSET = 3V, I <sub>dd</sub> = 25 mA)			High Power* (VSET = 3V, I <sub>dd</sub> = 40 mA)			Units
	Min.	Typ.	Max.	Min.	Typ.	Max.	Min.	Typ.	Max.	
Frequency Range	5 - 6			5 - 6			5 - 6			GHz
Gain	8	10	16	8	12	16	9	13	16	dB
Gain Variation over Temperature		0.025	0.035		0.025	0.035		0.025	0.035	dB/°C
Gain Flatness		±0.5			±1.0			±1.5		dB
Noise Figure		2.7	3.8		2.5	3.8		2.6	3.8	dB
Input Return Loss	4	10		4	10		4	10		dB
Output Return Loss	7	13		10	18		10	20		dB
Output Power for 1 dB Compression (P1dB)	-4	-1		6	9		9	12		dBm
Input Third Order Intercept Point (IIP3)	-3	1		4	8		6	10		dBm
Supply Current (I <sub>dd</sub> )		7			25			40		mA

\* R<sub>BIAS</sub> resistor value sets current. See adaptive biasing application note.

Information furnished by Analog Devices is believed to be accurate and reliable. However, no responsibility is assumed by Analog Devices for its use, nor for any infringements of patents or other rights of third parties that may result from its use. Specifications subject to change without notice. No license is granted by implication or otherwise under any patent or patent rights of Analog Devices. Trademarks and registered trademarks are the property of their respective owners.

For price, delivery, and to place orders: Analog Devices, Inc., One Technology Way, P.O. Box 9106, Norwood, MA 02062-9106  
Phone: 781-329-4700 • Order online at [www.analog.com](http://www.analog.com)  
Application Support: Phone: 1-800-ANALOG-D



**GaAs MMIC LOW NOISE AMPLIFIER, 5 - 6 GHz**

**Broadband Gain & Return Loss  
Medium Power Bias**

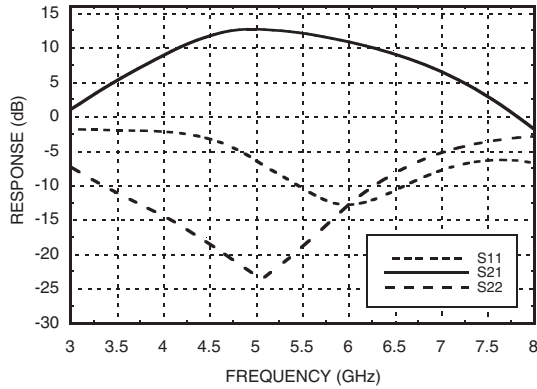

**Gain @ Three Bias Conditions**

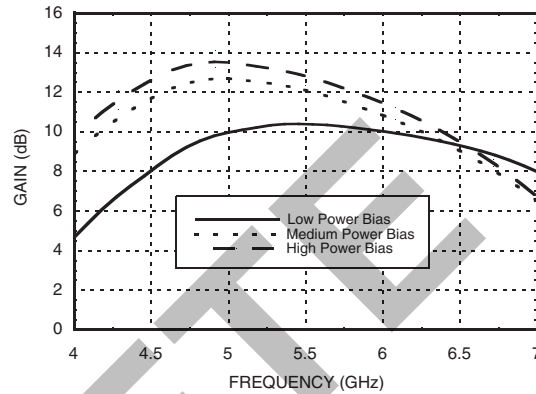

**Gain vs. Temperature  
Medium Power Bias**

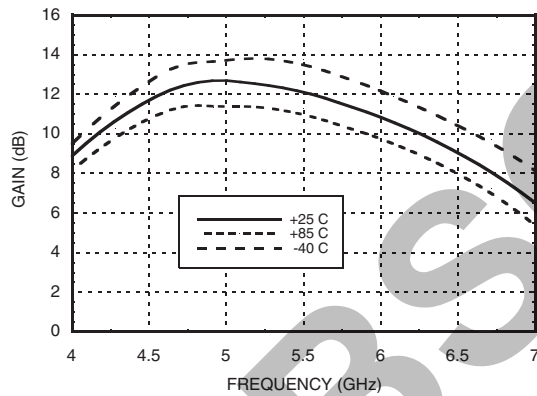

**Input Return Loss  
@ Three Bias Conditions**

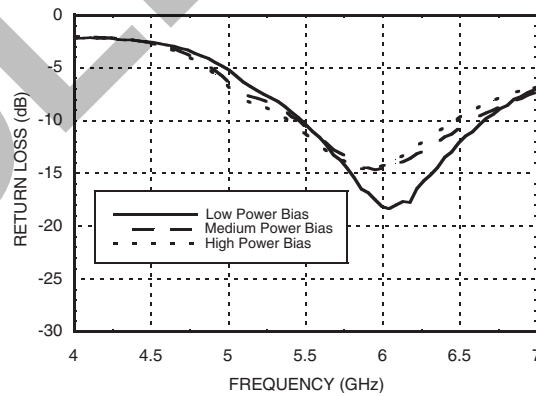

**Noise Figure vs. Temperature  
Medium Power Bias**

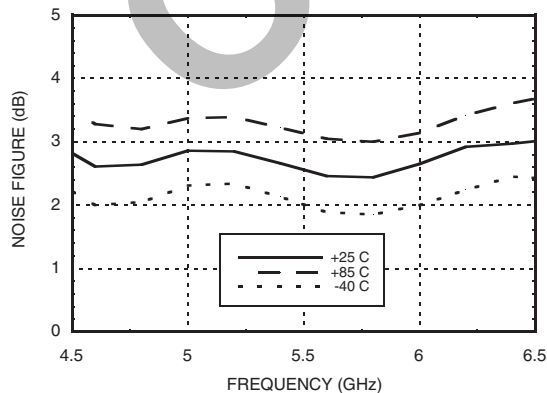

**Output Return Loss  
@ Three Bias Conditions**

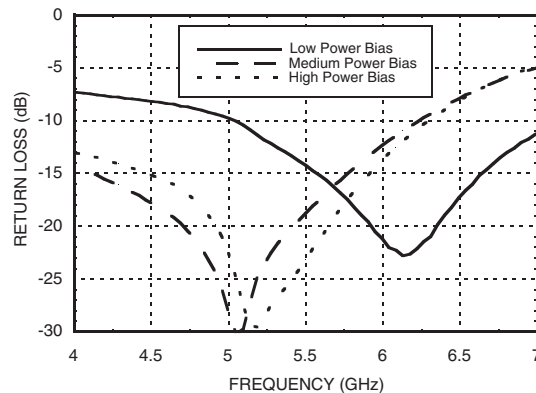

Information furnished by Analog Devices is believed to be accurate and reliable. However, no responsibility is assumed by Analog Devices for its use, nor for any infringements of patents or other rights of third parties that may result from its use. Specifications subject to change without notice. No license is granted by implication or otherwise under any patent or patent rights of Analog Devices. Trademarks and registered trademarks are the property of their respective owners.

For price, delivery, and to place orders: Analog Devices, Inc., One Technology Way, P.O. Box 9106, Norwood, MA 02062-9106 Phone: 781-329-4700 • Order online at [www.analog.com](http://www.analog.com) Application Support: Phone: 1-800-ANALOG-D



**GaAs MMIC LOW NOISE AMPLIFIER, 5 - 6 GHz**

**Noise Figure @ Three Bias Conditions**

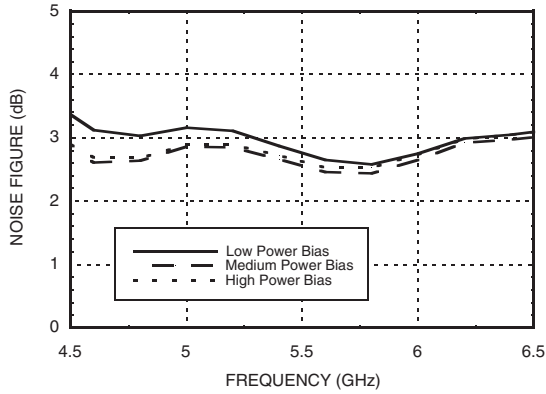

**Input IP3 @ Three Bias Conditions**

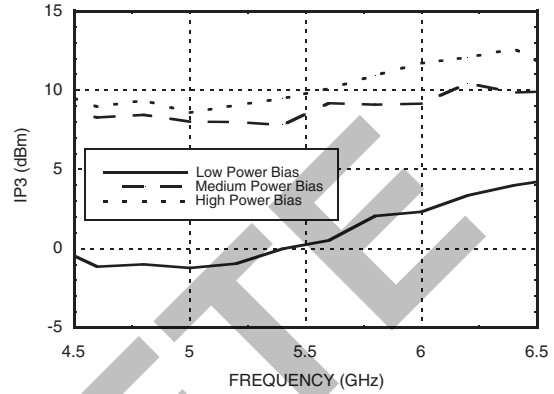

**Output 1dB Compression @ Three Bias Conditions**

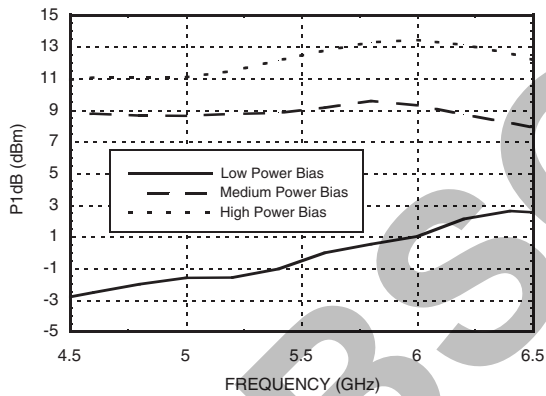

**Reverse Isolation @ Three Bias Conditions**

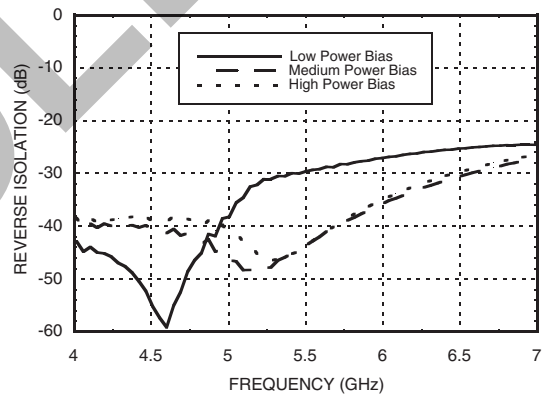



### Adaptive Biasing

#### Optimizing P1dB Performance

The bias level may be changed to adjust the P1dB and return loss performance. The table below contains the HMC-320MS8G RF performance as a function of various VSET and RBIAS settings. It will be necessary for the VSET voltage source to provide 100uA of current to the amplifier. The Idd and Vdd quiescent performance will not change as a function of changing the VSET voltage.

#### RF Performance at 5.8 GHz (Vdd = +3V)

VSET (VDC)	RBIAS Resistor Between Pin 3 and GND (Ohms)	Idd (mA)	Output P1dB (dBm)	Output Return Loss (dB)
0	174	7	1.0	16.0
3	22	25	9.0	12.0
3	7	40	13.0	15.0
3	GND (No Resistor)	60	14.0	15.0

#### Applying the adaptive biasing

A dynamically controlled bias can be implemented with this design. A typical application will include sensing an RF signal level and then adjusting the VSET. The bias adjustment can be accomplished by either analog or digital means, after the RF signal has been detected and translated to a DC voltage using external power detection circuitry.

#### Schematic

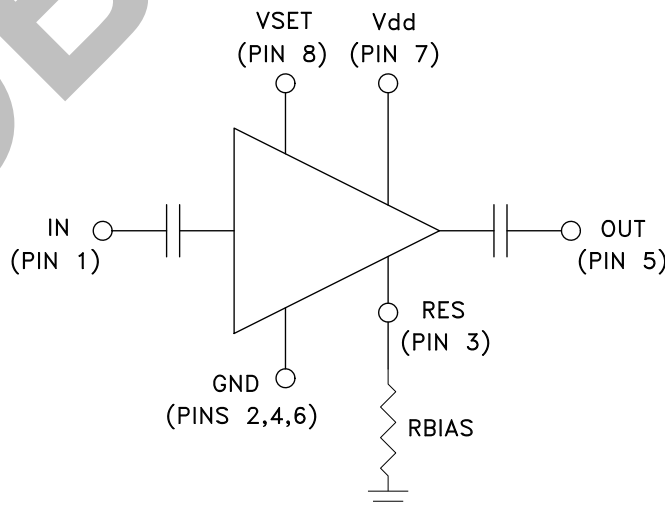



### Absolute Maximum Ratings

Drain Bias Voltage (Vdd)	+7.0 Vdc
Control Voltage Range (VSET)	0 to Vdd
RF Input Power (RFIN)(Vdd = +3.0 Vdc)	+5 dBm
Channel Temperature	150 °C
Continuous Pdiss (T = 85 °C) (derate 2.98 mW/°C above 85 °C)	0.194 W
Thermal Resistance (channel to ground paddle)	336 °C/W
Storage Temperature	-65 to +150 °C
Operating Temperature	-40 to +85 °C
ESD Sensitivity (HBM)	Class 1A

### Truth Table

VSET	Operating Current Idd	Operating State	Resistor Rbias
0V	7 mA	Low Power	174 Ohm
3V	25 mA	Medium Power	22 Ohm
3V	40 mA	High Power	7 Ohm

Set external bias resistor (RBIAS) to achieve desired operating current, 0 < RBIAS < 200 Ohm.



**ELECTROSTATIC SENSITIVE DEVICE  
OBSERVE HANDLING PRECAUTIONS**

### Outline Drawing

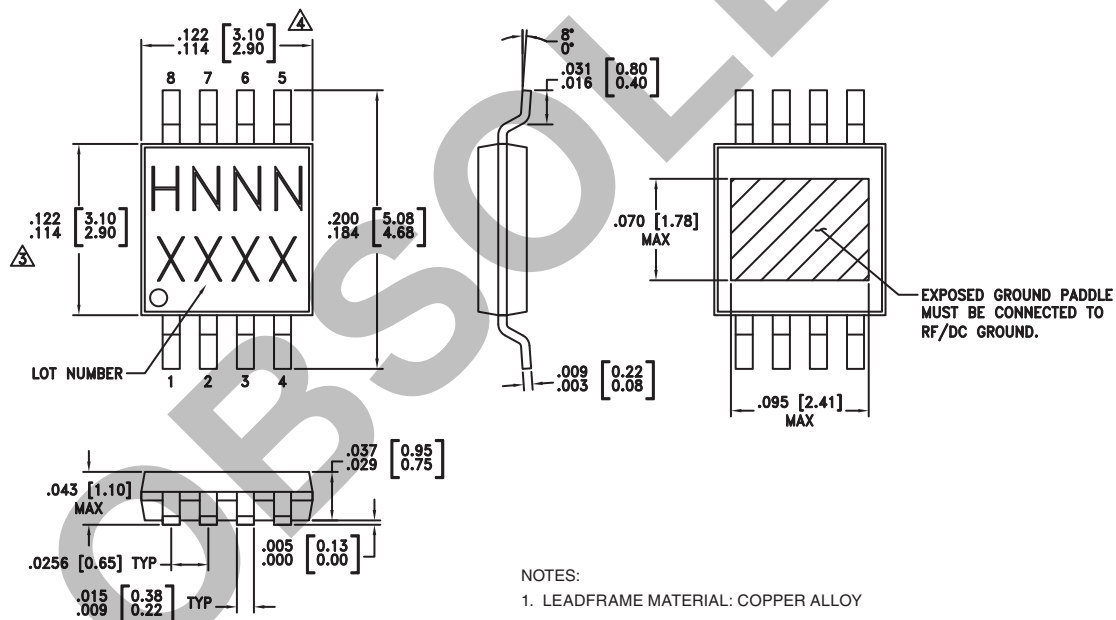

### Package Information

Part Number	Package Body Material	Lead Finish	MSL Rating	Package Marking <sup>[3]</sup>
HMC320MS8G	Low Stress Injection Molded Plastic	Sn/Pb Solder	MSL1 <sup>[1]</sup>	H320 XXXX
HMC320MS8GE	RoHS-compliant Low Stress Injection Molded Plastic	100% matte Sn	MSL1 <sup>[2]</sup>	H320 XXXX

[1] Max peak reflow temperature of 235 °C

[2] Max peak reflow temperature of 260 °C

[3] 4-Digit lot number XXXX



**Evaluation PCB**

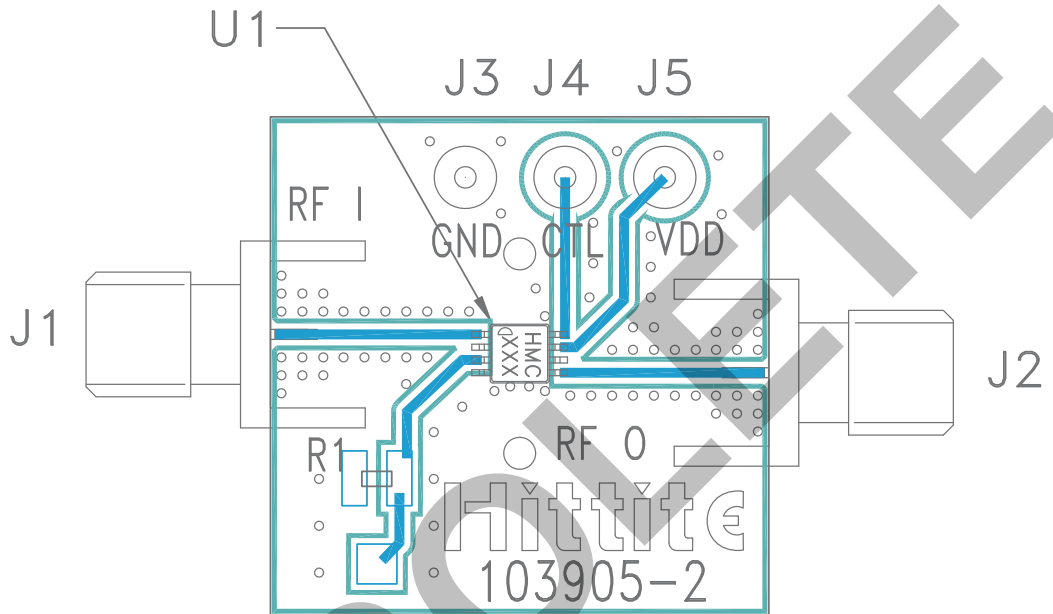

**List of Materials for Evaluation PCB 103907 [1]**

Item	Description
J1, J2	PCB Mount SMA Connector
J3, J4, J5	DC Pins
R1	22 Ohm Resistor, 0603 Pkg.
U1	HMC320MS8G / HMC320MS8GE Amplifier
PCB [2]	103905 Evaluation PCB

[1] Reference this number when ordering complete evaluation PCB

[2] Circuit Board Material: Rogers 4350

The circuit board used in the final application should use RF circuit design techniques. Signal lines should have 50 ohm impedance while the package ground leads and exposed paddle should be connected directly to the ground plane similar to that shown. A sufficient number of via holes should be used to connect the top and bottom ground planes. The evaluation circuit board shown is available from Hittite upon request.