

A3C

Pushbutton Switch (Lighted/Non-Lighted) (Cylindrical 12-dia.)

Pushbutton Switch Series with Cylindrical 20-mm × 12-dia. Body

- High-intensity uniform surface lighting.
- Round body enables easy hole making.
- Miniature size with excellent feeling of operation.



RoHS Compliant

Refer to *Safety Precautions for All Pushbutton Switches/Indicators* and *Safety Precautions* on page 12.

List of Models

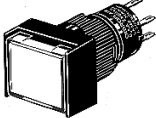
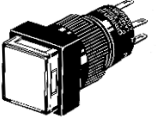
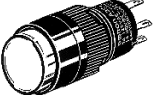
Appearance	Model
Rectangular Models 	A3CJ
Square Models 	A3CA
Round Models 	A3CT

■ Specifications: Refer to page 8. ■ Dimensions: Refer to page 9. ■ Accessories: Refer to page 7.
■ Precautions for correct use and safety precautions: Refer to page 12.

Model Number Legend..... When placing your order, specify the individual component part model numbers of the Pushbutton, Lamp (lighted models only), and Switch, as listed in the ordering tables below.

For information on combinations, refer to *Ordering Information* on page 3.

(1) (2) (3) (4) (5)
A 3 C J - 9 0 A 1 - 2 4 E R

(1) Shape of Pushbutton

Symbol	Shape
J	Rectangular
A	Square
T	Round

(2) Switch Specifications Standard Load

Symbol	Type	Operation	Contact
A	Solder terminal	Momentary	1a1b
B		Alternate	

Microload

Symbol	Type	Operation	Contact
E	Solder terminal	Momentary	1a1b
F		Alternate	

- Standard Load
 0.5 A at 250 VAC
 1 A at 125 VAC
 1 A at 30 VDC
- Microload
 0.1 A at 125 VAC
 0.1 A at 30 VDC

Minimum applicable load
 1 mA at 5 VDC

Momentary-action: Self-resetting
 Alternate-action: Self-holding

(3) Lighted/Non-lighted

Symbol	Type
0	Non-lighted
1	Illumination only

(4) Lighting Method LED Lamp-lighted Models

Symbol	Operating voltage
05E	5 VDC
12E	12 VDC
24E	24 VDC

Non-lighted Models

No symbol

(5) Color of Pushbutton For LED Lamp

Symbol	Color
R	Red
Y	Yellow
G	Green
W	White

For Non-lighted Models

Symbol	Color
R	Red
Y	Yellow
G	Green
W	White
A	Blue
B	Black

Ordering Information

Ordering as a SetThe model numbers used to order sets of Units are given in the following tables. One set comprises the Pushbutton, Lamp (lighted models only), and Switch.

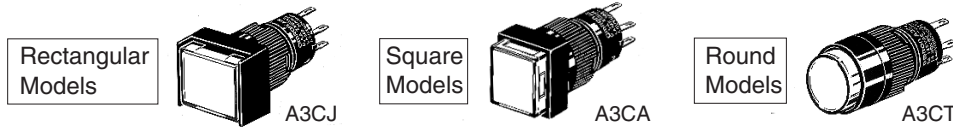

Lighted Pushbutton Switches (SPST-NO+SPST-NC Solder Terminals)

Shape	Lighting	Standard load		Microload	Pushbutton color symbol (Color)	Minimum packing unit		
		Momentary operation (Self-resetting)	Alternate operation (Self-holding)	Momentary operation (Self-resetting)				
		Set	Set	Set				
Rectangular (A3CJ)	LED lamp	A3CJ-90A1-05E□	A3CJ-90B1-05E□	A3CJ-90E1-05E□	R: red Y: yellow G: green W: white	10 pcs		
		A3CJ-90A1-12E□	A3CJ-90B1-12E□	A3CJ-90E1-12E□				
		A3CJ-90A1-24E□	A3CJ-90B1-24E□	A3CJ-90E1-24E□				
	Non-lighted	A3CJ-90A0-□	A3CJ-90B0-□	A3CJ-90E0-□	R: red Y: yellow G: green W: white A: blue B: black *			
		Square (A3CA)	LED lamp	A3CA-90A1-05E□	A3CA-90B1-05E□		A3CA-90E1-05E□	R: red Y: yellow G: green W: white
				A3CA-90A1-12E□	A3CA-90B1-12E□		A3CA-90E1-12E□	
A3CA-90A1-24E□	A3CA-90B1-24E□			A3CA-90E1-24E□				
Non-lighted	A3CA-90A0-□	A3CA-90B0-□	A3CA-90E0-□	R: red Y: yellow G: green W: white A: blue B: black *				
	Round (A3CT)	LED lamp	A3CT-90A1-05E□	A3CT-90B1-05E□	A3CT-90E1-05E□	R: red Y: yellow G: green W: white		
			A3CT-90A1-12E□	A3CT-90B1-12E□	A3CT-90E1-12E□			
A3CT-90A1-24E□			A3CT-90B1-24E□	A3CT-90E1-24E□				
Non-lighted		A3CT-90A0-□	A3CT-90B0-□	A3CT-90E0-□	R: red Y: yellow G: green W: white A: blue B: black *			

Note: 1. Enter the desired color symbol for the Pushbutton in the □ at the end of the model number.
 2. There are also alternate-operation models that can be used for microloads. Refer to the Switch table on page 6.
 * Black ("B") Pushbuttons are only available for non-lighted models.

Individual models: Refer to pages 5 to 6.
 (The Pushbutton, Lamp, and Switch can be ordered separately.)

■ Specifications: Refer to page 8. ■ Dimensions: Refer to page 9.
 ■ Accessories: Refer to page 7.

Ordering Information

Illumination-only and Colored-illumination LED Models

"Illumination only" describes LED models for which the screen color is the same whether the LED is lit or not.

Example: Red LED

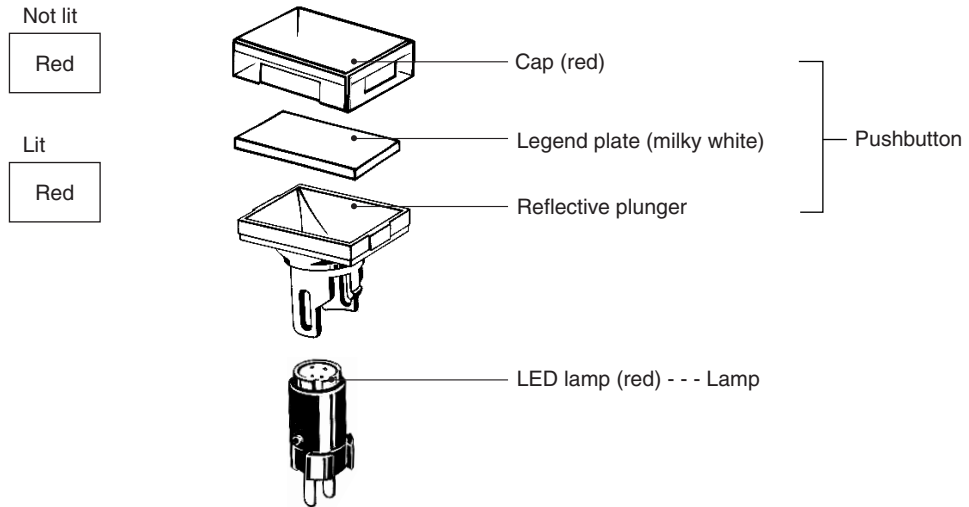

"Colored illumination" describes LED models for which the screen color is white when the LED is not lit and changes to the color of the LED lamp when the LED is lit.

Example: Red LED

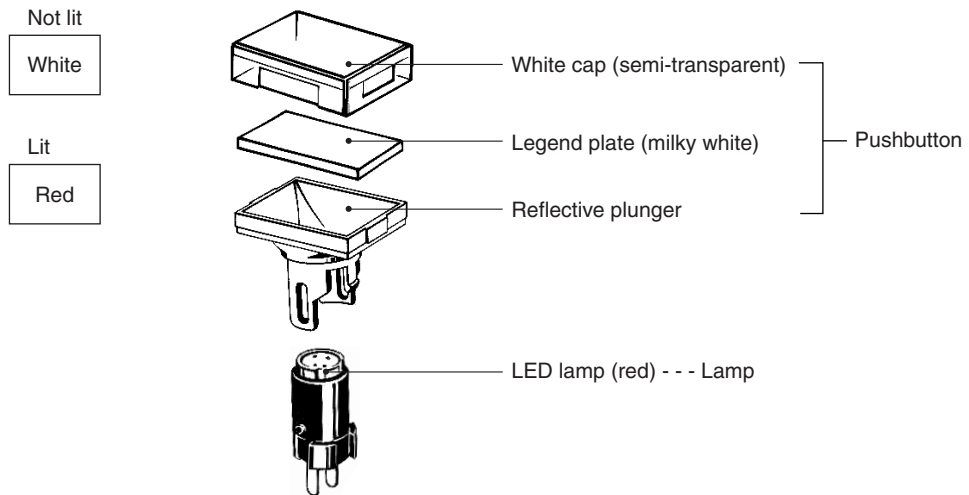

Ordering: With colored-illumination models, order the Pushbutton, Lamp, and Switch as shown in the following table.

Illuminated color	Pushbutton	Lamp (LED)	Switch
Red	IP40 A3C□-500W Enter one of the following symbols in □. J: Rectangular A: Square T: Round	A16-□DR	Refer to page 6. Make the selection according to the shape of the Pushbutton.
Yellow		A16-□DY	
Green		A16-□DG	

Ordering Information

Ordering IndividuallyPushbuttons, Lamps, and Switches can be ordered separately. Combinations that are not available as sets can be created using individual Units. Also, store the parts as spares for maintenance and repairs.

Ordering: Specify a model number from the following page.

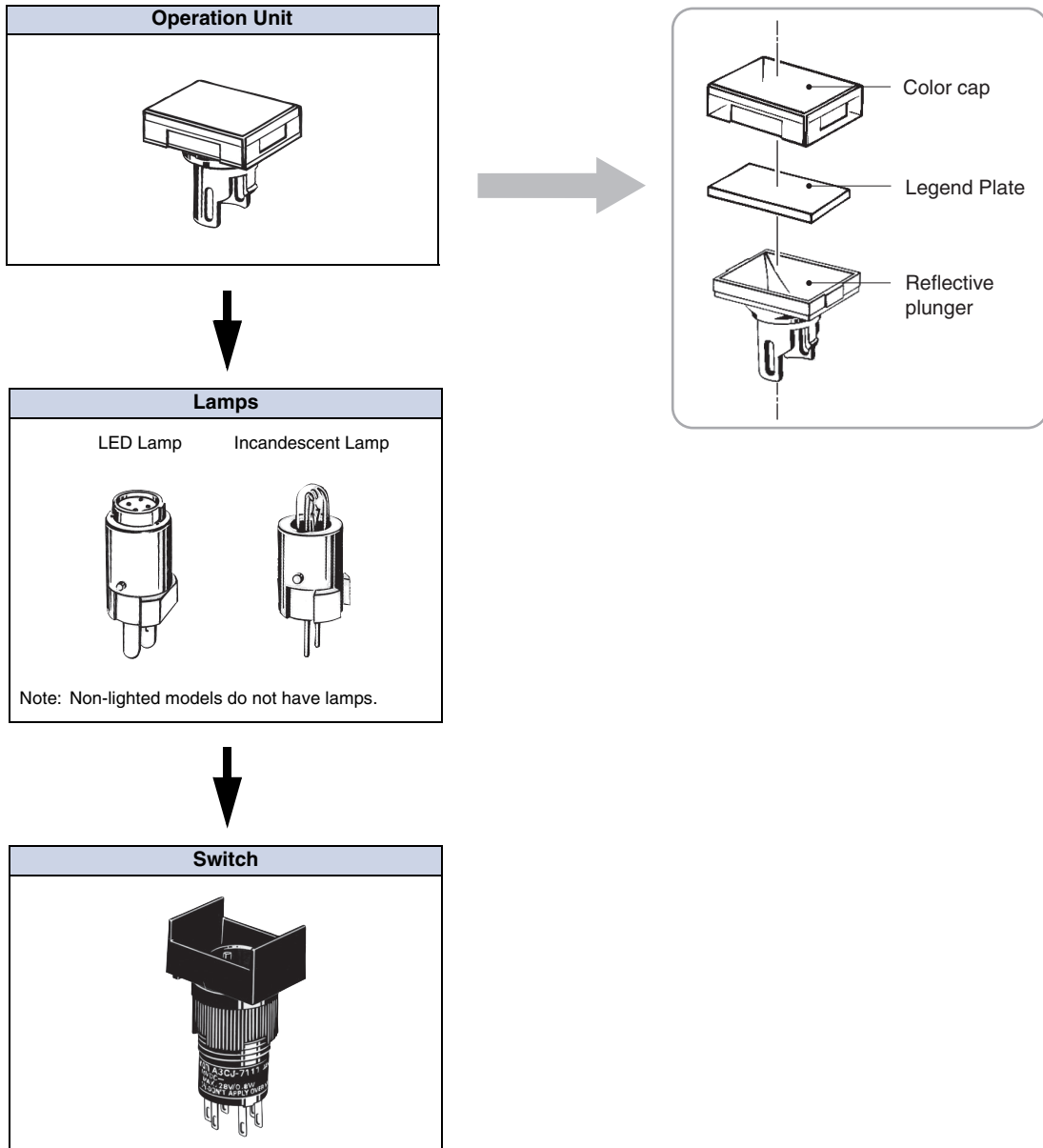

A
3
C

Ordering set combinations: Refer to page 3.



■ Specifications: Refer to page 8. ■ Dimensions: Refer to page 9.
■ Accessories: Refer to page 7.

Ordering Information

Ordering Individually Pushbuttons, Lamps, and Switches can be ordered separately. Combinations that are not available as sets can be created using individual Units. Also, store the parts as spares for maintenance and repairs.



Pushbuttons

LED Lamp



Shape	Rectangular	Square	Round
Button color			
Red	A3CJ-500R	A3CA-500R	A3CT-500R
Yellow	A3CJ-500Y	A3CA-500Y	A3CT-500Y
Green	A3CJ-500GY	A3CA-500GY	A3CT-500GY
White	A3CJ-500W	A3CA-500W	A3CT-500W
Minimum packing unit	50 pcs		

Note: The red, yellow, and white Pushbuttons listed above can be used with either LED lamp-lighted models or incandescent lamp-lighted models.

Incandescent Lamp

Shape	Rectangular	Square	Round
Button color			
Red	A3CJ-500R	A3CA-500R	A3CT-500R
Yellow	A3CJ-500Y	A3CA-500Y	A3CT-500Y
Green	A3CJ-500G	A3CA-500G	A3CT-500G
White	A3CJ-500W	A3CA-500W	A3CT-500W
Blue	A3CJ-500A	A3CA-500A	A3CT-500A
Minimum packing unit	50 pcs		

Non-lighted Models

Shape	Rectangular	Square	Round
Button color			
Red	A3CJ-500R	A3CA-500R	A3CT-500R
Yellow	A3CJ-500Y	A3CA-500Y	A3CT-500Y
Green	A3CJ-500G	A3CA-500G	A3CT-500G
White	A3CJ-500W	A3CA-500W	A3CT-500W
Blue	A3CJ-500A	A3CA-500A	A3CT-500A
Black	A3CJ-501B	A3CA-501B	A3CT-501B
Minimum packing unit	50 pcs		

Note: Models other than black can also be used with incandescent lamps.

Lamps

LED Lamp

Color Rated voltage	Red	Yellow	Green	White	Minimum packing unit
5 VDC	A16-5DR	A16-5DY	A16-5DG	A16-5DW	100 pcs
12 VDC	A16-12DR	A16-12DY	A16-12DG	A16-12DW	
24 VDC	A16-24DR	A16-24DY	A16-24DG	A16-24DW	

Switches

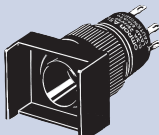
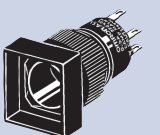
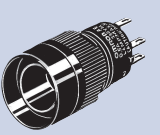
Sealing				Degree of protection: IP40				
				Rectangular	Square	Round		
Shape								
				Contact type			Switch action	
Standard load	SPST-NO+ SPST NC	Momentary	Solder	A3CJ-7011	A3CA-7011	A3CT-7011		
		Alternate		A3CJ-7021	A3CA-7021	A3CT-7021		
Microload		Momentary	Solder	A3CJ-7111	A3CA-7111	A3CT-7111		
		Alternate		A3CJ-7121	A3CA-7121	A3CT-7121		
Minimum packing unit				10 pcs				

Ordering set combinations: Refer to page 3.



■ Specifications: Refer to page 8. ■ Dimensions: Refer to page 9.

■ Accessories: Refer to page 7.

Ordering Information

Accessories, Replacements, and Tools

Accessories

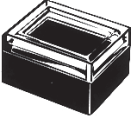
Name	Appearance	Classification	Model	Remarks	Minimum packing unit
Socket		PCB terminal	A3C-4102	Cannot be used with Insulation Cover.	50 pcs
		Solder terminal	A3C-4103		
Insulation Cover		---	A3C-3002	Cannot be used with Socket.	100 pcs
Switch Guard		For rectangular models	A3CJ-5050	Cannot be used with Dust Cover.	25 pcs
		For square, round models	A3CA-5050		
Dust Cover		For rectangular models	A3CJ-5060	Cannot be used with Switch Guard. Can be used with Dust Cover attached.	

Tools

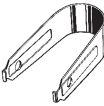
Name	Appearance	Classification	Model	Remarks	Minimum packing unit
Tightening Tool		---	A3C-3004	The tightening torque is 0.20 to 0.39 N-m.	10 pcs
Extractor		---	A3PJ-5080	---	

Replacements

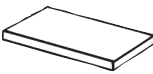
Name	Appearance	Classification	Model	Remarks	Minimum packing unit
Legend Plate		For rectangular models	A3CJ-5201	One Legend Plate (milk-white) is supplied per standard Switch.	100 pcs
		For square models	A3CA-5201		
		For round models	A3CT-5201		

■ Specifications: Refer to page 8. ■ Dimensions: Refer to page 9.

Approved Standard Ratings

UL (File No. E41515), CSA (File No. LR45258)

Standard Load:	0.5 A at 250 VAC 1 A at 125 VAC 1 A at 30 VDC
Microload:	0.1 A at 125 VAC 0.1 A at 30 VDC

Note: Certification has been obtained for the Switch Unit.
For detailed information on individual products that have received certification, consult your supplier.

CCC (GB14048.5)

Standard Load:	0.5 A at 250 VAC
Microload:	0.1 A at 250 VAC

Ratings

Model	Item	AC resistive load	DC resistive load
Standard load		0.5 A at 250 VAC 1 A at 125 VAC	1 A at 30 VDC
	Microload	0.1 A at 125 VAC	0.1 A at 30 VDC

Note: Minimum allowable load: 5 VDC 1 mA (Resistive)
The ratings given above are for testing under the following conditions:
(1) Ambient temperature: 20 ± 2°C
(2) Ambient humidity: 65 ± 5%RH
(3) Operating frequency: 20 times/minute

LED Lamp

Rated voltage	Rated current	Operating voltage	Internal limiting resistance
5 VDC	30 mA	5 VDC ± 5%	33 Ω
12 VDC	15 mA	12 VDC ± 5%	270 Ω
24 VDC	10 mA	24 VDC ± 5%	1,600 Ω

Incandescent Lamp

Rated voltage	Rated current	Operating voltage
6 VAC/DC	60 mA	5 VAC/DC
14 VAC/DC	40 mA	12 VAC/DC
28 VAC/DC	24 mA	24 VAC/DC

Characteristics

Operating frequency	Mechanical	Momentary-action models: 120 operations/minute max. Alternate-action models: 60 operations/minute max. *1
	Electrical	20 operations/minute max.
Contact resistance (initial value)	Standard load	50mΩ max.
	Microload	100mΩ max.
Insulation resistance		100 MΩ min. (at 500 VDC with insulation tester)
Dielectric strength	Between terminals of same polarity	1,000 VAC, 50/60 Hz for 1 min
	Between terminals of different polarity	2,000 VAC, 50/60 Hz for 1 min
	Between each terminal and ground	2,000 VAC, 50/60 Hz for 1 min
	Between lamp terminals	1,000 VAC, 50/60 Hz for 1 min *2
Vibration resistance	Malfunction	10 to 55 Hz, 1.5-mm double amplitude *3
Shock resistance	Destruction	500 m/s ² max.
	Malfunction	150 m/s ² max. *3
Durability	Mechanical	Momentary-operation models: 1,000,000 operations min. Alternate-operation models: 100,000 operations min. *1
	Electrical	100,000 operations min.
Weight		Approx. 5 g <The weight indicated here applies to the lighted models (SPST-NO+SPST-NC).>
Ambient operating temperature		-10°C to +55°C (with no icing or condensation)
Ambient operating humidity		35% to 85%RH
Ambient storage temperature		-25°C to +65°C (with no icing or condensation)
Degree of protection		IEC IP40
Electric shock protection class		Class II
PTI (proof tracking index)		175
Pollution degree		3 (IEC60947-5-1)

- *1. With alternate-operation models, one operation cycle consists of set and reset operations.
*2. The figure given above for the dielectric strength between lamp terminals is for when there is no LED lamp or incandescent lamp mounted.
*3. No malfunction for more than 1s.

Operating Characteristics

Operating force	OF max.	2.45 N
Releasing force	RF min.	0.29 N
Total travel	TT	Approx. 3.5 mm
Lock travel alternate	LTA min. *	0.5 mm
Pretravel	PT max.	2.5 mm

* Alternate operation models only.

Contact Form

Contact name	Contact form
SPDT	

Dimensions

(Unit: mm)

Rectangular Models/A3CJ

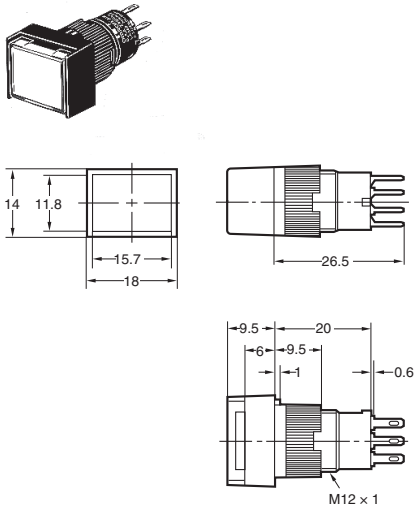

Square Models/A3CA

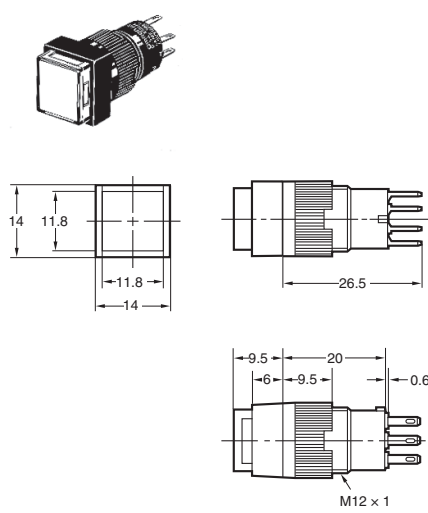

Round Models/A3CT

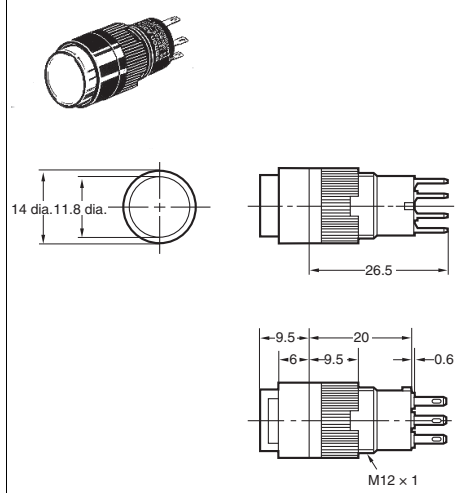

Terminal Connections

Terminal	SPST-NO + SPST-NC Lighted and non-lighted models
Solder terminal	

Panel Cutout (Top View)

Accessories used	Rectangular/A3CJ	Square/A3CA, Round/A3CT
Switch only	<p>Note: Recommended panel thickness: 1.0 to 3.2 mm.</p>	<p>Note: Recommended panel thickness: 1.0 to 3.2 mm.</p>
With Switch Guard		
With Dust Cover		

• If the panel is to be finished (e.g., coated), make sure that the panel meets the specified dimensions after the coating.

Dimensions

(Unit: mm)

Accessory Mounting Dimensions

Dimensions with Socket Mounted (The diagrams below show the external dimensions for rectangular models as representative models.)

PCB Terminal/A3C-4102

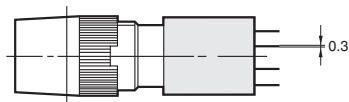
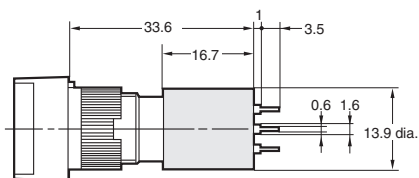

PCB Cutout (BOTTOM VIEW)

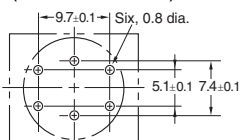

Solder Terminal/A3C-4103

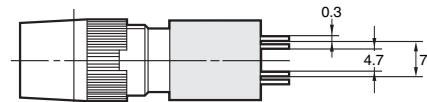
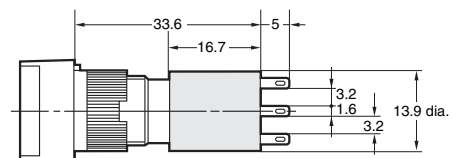

Terminal Hole Dimensions

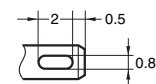

Switch Guard

Rectangular A3CJ-5050

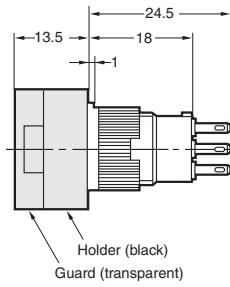
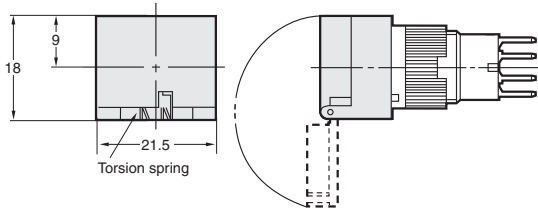

Square/Round A3CA-5050

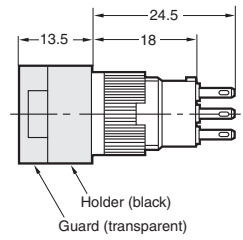
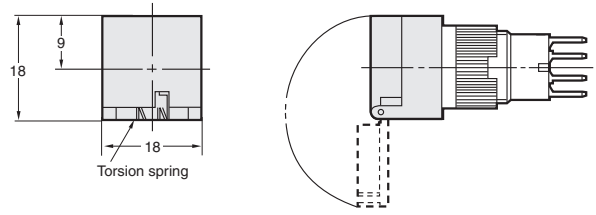

A
3
C

Dust Cover A3CJ-5060

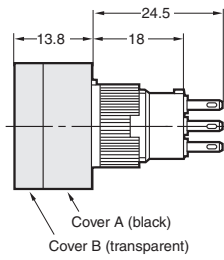
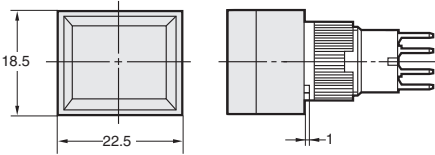

Legend Plate

Rectangular A3CJ-5201

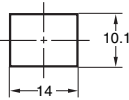

Square A3CA-5201

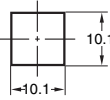

Round A3CT-5201

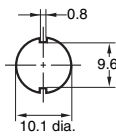

- Note: 1. The thickness is 0.8 mm.
2. Since the Legend Plate is made of polycarbonate, use alcohol-based paints such as melanin, phthalic acid, or acrylic paint when marking the legend.

Insulation Cover A3C-3002

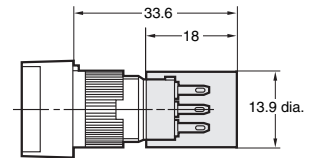

Safety Precautions

Refer to *Safety Precautions for All Pushbutton Switches/Indicators*.

CAUTION

Do not apply a voltage higher than the maximum rated operating voltage between the lamp terminals, as there is a risk that the incandescent lamp or LED lamp will be damaged, and the Pushbutton will be ejected.



When replacing the incandescent lamp, first turn OFF the power supply, and then wait 10 minutes before performing replacement, as the lamp is still hot immediately after the power is turned OFF, so there is a risk of burns.



Precautions for Correct Use

Mounting

- To prevent electric shock or a fire, always make sure that the power is turned OFF before mounting, removing, or wiring the Switch, or performing maintenance.
- Do not tighten the mounting ring excessively using pliers or a similar tool. Excessive tightening may damage the mounting ring. (Tightening torque: 0.20 to 0.39 N·m)

Wiring

- When wiring, use wires of a size appropriate for the applied voltage and carry current. Perform soldering correctly under the conditions given below. Using the Switch with the wires soldered incorrectly may cause the terminals to become abnormally hot and cause a fire.
 1. Soldering iron tip temperature: 350°C max. within 3 seconds.
 2. Dip soldering: At 350°C within 3 seconds.
 - Wait for one minute after soldering before exerting any external force on the solder.
- Use a non-corrosive rosin liquid for the flux.
- Perform wiring so that the wire sheaths do not come into contact with the Switch. If this is unavoidable, use wires that can withstand temperatures of 100°C min.
- After wiring to the Switch has been completed, ensure an appropriate insulation distance.

Operating Environment

- Do not use in locations that are subject to dust, oil, or metal filings as these may penetrate the interior of the Switch and cause malfunction.

Using Microloads

- Using a standard load switch for opening and closing a microload circuit may cause wear on the contacts. Use the switch within the operating range. (Refer to the diagram below.) Even when using microload models within the operating range shown below, if inrush current occurs when the contact is opened or closed, it may cause the contact surface to become rough, and so decrease life expectancy. Therefore, insert a contact protection circuit where necessary. The minimum applicable load is the N-level reference value. This value indicates the malfunction reference level for the reliability level of 60% ($\lambda 60$) (conforming to JIS C5003). The equation, $\lambda 60 = 0.5 \times 10^{-6}$ /times indicates that the estimated malfunction rate is less than 1/2,000,000 with a reliability level of 60%.

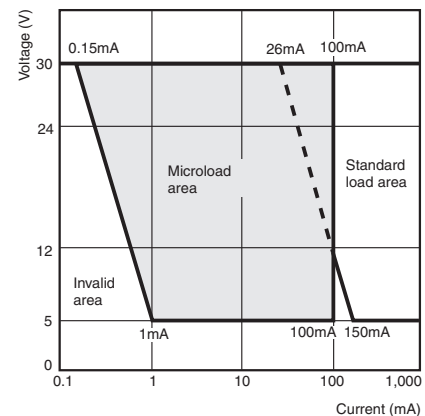

LED

- Resistance to limit the LED current is provided internally and so an external resistance is not required.

Rated voltage	Internal limiting resistance
5 VDC	33 Ω
12 VDC	270 Ω
24 VDC	1,600 Ω

Application

Mounting and Replacing the Pushbutton

(1) Mounting Direction for the Pushbutton/Display and Lamp Lighted Pushbutton Switch

- Insert the Lamp (incandescent lamp or LED lamp) into the Pushbutton so that the lamp guide fits into the wider gap between the projections on the Pushbutton.

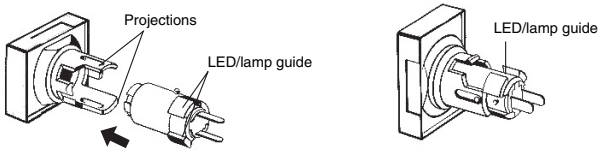

Indicator

- With Indicators, the Lamp is inserted facing the opposite direction (i.e., at 180°) to that for Lighted Pushbutton Switches.

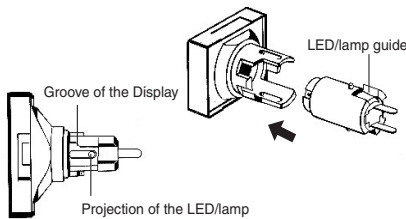

Note: Push the projections on the Lamp into the grooves on the Pushbutton/Display. The Lamp for Lighted Pushbutton Switches moves, but the Lamp for Indicators is fixed.

(2) Mounting Direction for the Pushbutton/Display and Switch

- Insert the Pushbutton/Display into the Switch so that the lamp guide is aligned with the non-projecting part of the Switch.
- Apply a pressure between 9.8 and 24.5 N.

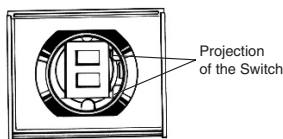

- Note: 1. The mounting direction for Indicators is 180° to that for Lighted Pushbutton Switches. Be sure to insert the Legend Plate and other parts with the correct orientation.
2. If the terminals of the Lamp become bent, it may be impossible to fit them into the lamp terminal holes. Ensure that the terminals are straight when they are inserted.
 3. Take particular care about the mounting direction with the round models (A3CT).

(3) Removing the Pushbutton/Display

Hold the recessed portions on the cap of the Pushbutton and pull.



Note: Do not use tools such as pliers to remove the Pushbutton as this may damage the cap.

Panel Mounting

- Insert the Switch from the front of the panel. Mount the mounting nut from the terminal end of the Switch and tighten it.
- There are projections on the terminal end of the Switch which may, depending on the orientation, block the nut. In this case, turn the nut until it is possible to mount it. Tighten the nut to a torque between 0.20 and 0.39 N·m.
- If soldering is used, mount the mounting nut first. Lead wires and mounds of solder may make it impossible to mount the nut after soldering.

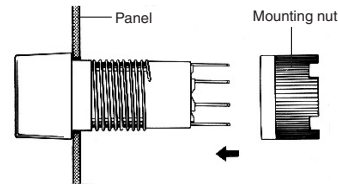

Socket Mounting

- After securing the Switch to the panel using the mounting nut, insert the Socket into the Switch.
- Align the positioning holes of the Socket with the projections of the Switch before inserting the Socket.

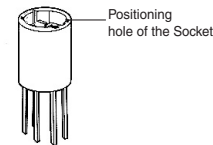
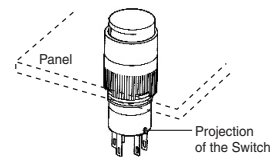

Mounting the Insulation Cover

- After securing the Switch to the panel using the mounting nut, pass the lead wires through the holes in the Insulation Cover and then perform wiring. Hold the Insulation Cover so that the cylindrical hole is facing the Switch, and insert the lead wires from the end with the barriers.
- After wiring is completed, mount the Insulation Cover by pushing it into the Switch.

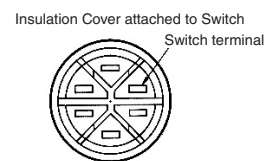

Mounting the Dust Cover

1. The Dust Cover separates into 2 parts: the cap and the mounting frame.
2. Insert the Switch into the mounting frame. (Align the lock projection with the recess on the mounting frame.)
3. Insert the Switch in the state described in step 2 into the panel. (Align the lock protrusion on the mounting frame with the hole in the panel.)
4. Mount the mounting nut from the back of the panel and tighten it.
5. Insert the cap into the mounting frame. Ensure that the entire perimeter of the cap is properly inserted into the mounting frame by pressing down on the cap from different directions.

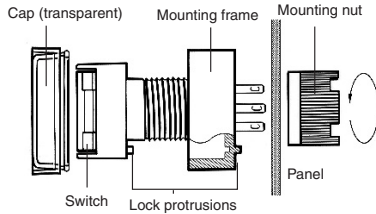

Mounting the Switch Guard

1. Insert the Switch into the Switch Guard.
2. Insert the Switch into the panel in the state described in step 1.
3. Mount the mounting nut from the back of the panel and tighten it.

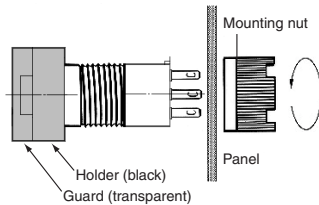

Please check each region's Terms & Conditions by region website.

OMRON Corporation

Electronic and Mechanical Components Company

Regional Contact

Americas

<https://www.components.omron.com/>

Asia-Pacific

<https://ecb.omron.com.sg/>

Korea

<https://www.omron-ecb.co.kr/>

Europe

<http://components.omron.eu/>

China

<https://www.ecb.omron.com.cn/>

Japan

<https://www.omron.co.jp/ecb/>