



Quartz Crystal

SMD-version

model	KX – 4T
frequency	32,0 MHz
mode	fundamental
operating temperature	-40° ~ + 85°C
frequency tolerance at +25°C	± 10 ppm
temperature tolerance -40° ~ + 85°C	± 15 ppm
load capacitance C_L	8 pF
series resonance R_1 max.	80 Ohm
aging at +25°C (first year) max.	± 2 ppm
shunt capacitance C_O max.	5,0 pF
drive level max.	200 μ W
contents of reel	1000 pcs.
part no.	12.84814

Dimensions (mm):

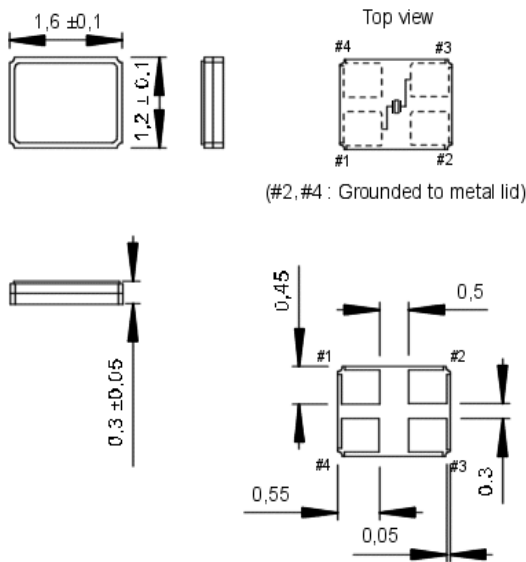

Reflow soldering condition:

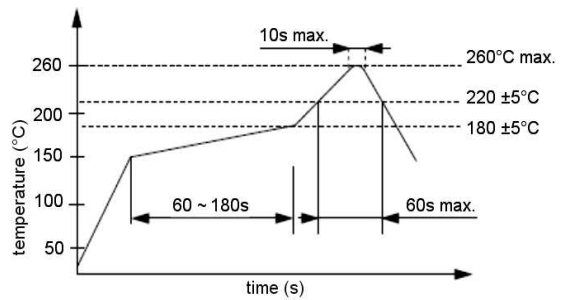

Tape specification:

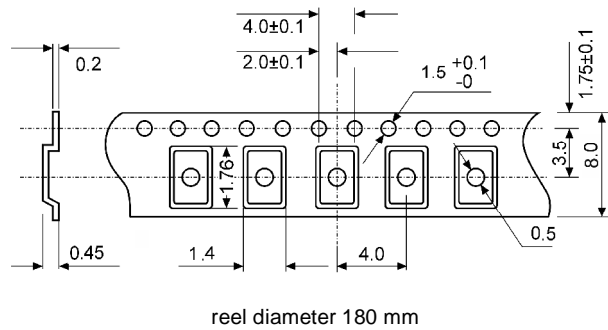

Suggested soldering pad:

