

Dual N-Channel 30-V (D-S) MOSFET with Schottky Diode

PRODUCT SUMMARY			
	V_{DS} (V)	$R_{DS(on)}$ (Ω)	I_D (A)
Channel-1	30	0.022 at $V_{GS} = 10$ V	10
		0.030 at $V_{GS} = 4.5$ V	8
Channel-2		0.022 at $V_{GS} = 10$ V	10
		0.028 at $V_{GS} = 4.5$ V	8

SCHOTTKY PRODUCT SUMMARY		
V_{DS} (V)	V_{SD} (V) Diode Forward Voltage	I_F (A)
30	0.50 V at 1.0 A	3.0

FEATURES

- Halogen-free Option Available
- LITTLE FOOT® Plus Schottky
- PWM Optimized
- New Low Thermal Resistance PowerPAK® Package with low 1.07 mm Profile



RoHS
COMPLIANT

APPLICATIONS

- Asymmetrical Buck-Boost DC/DC Converter

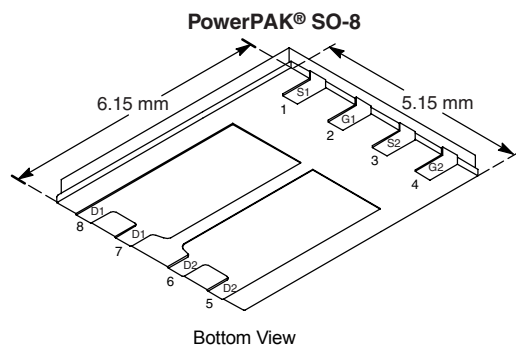

Ordering Information: Si7872DP-T1-E3 (Lead (Pb)-free)
Si7872DP-T1-GE3 (Lead (Pb)-free and Halogen-f

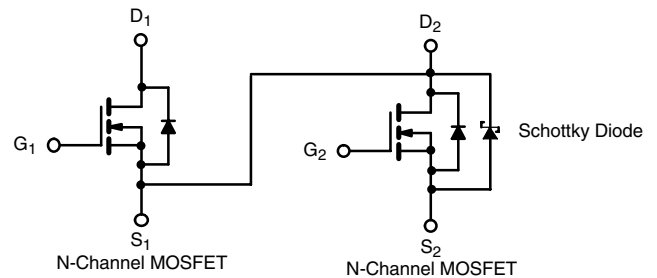

ABSOLUTE MAXIMUM RATINGS $T_A = 25$ °C, unless otherwise noted							
Parameter	Symbol	10 s		Steady State		Unit	
		Channel-1	Channel-2	Channel-1	Channel-2		
Drain-Source Voltage	V_{DS}	30				V	
Gate-Source Voltage	V_{GS}	± 20	± 12	± 20	± 12		
Continuous Drain Current ($T_J = 150$ °C) ^a	I_D	$T_A = 25$ °C	10	6.4		A	
		$T_A = 70$ °C	7	5.1			
Pulsed Drain Current	I_{DM}	30				A	
Continuous Source Current (Diode Conduction) ^a	I_S	2.9		1.1			
Maximum Power Dissipation ^a	P_D	$T_A = 25$ °C	3.5		1.4		W
		$T_A = 70$ °C	2.2		0.9		
Operating Junction and Storage Temperature Range	T_J, T_{stg}	- 55 to 150				°C	
Soldering Recommendations (Peak Temperature) ^{b,c}		260					

THERMAL RESISTANCE RATINGS							
Parameter	Symbol	MOSFET		Schottky		Unit	
		Typical	Maximum	Typical	Maximum		
Maximum Junction-to-Ambient ^a	R_{thJA}	$t \leq 10$ s	26	35	26	35	°C/W
		Steady State	60	85	60	85	
Maximum Junction-to-Case (Drain)	R_{thJC}	4.1	6.0	4.1	6.0		

Notes:

- a. Surface Mounted on 1" x 1" FR4 board.
b. See Solder Profile (<http://www.vishay.com/ppg?73257>). The PowerPAK SO-8 is a leadless package. The end of the lead terminal is exposed copper (not plated) as a result of the singulation process in manufacturing. A solder fillet at the exposed copper tip cannot be guaranteed and is not required to ensure adequate bottom side solder interconnection.
c. Rework Conditions: manual soldering with a soldering iron is not recommended for leadless components.

MOSFET SPECIFICATIONS $T_J = 25\text{ }^\circ\text{C}$, unless otherwise noted							
Parameter	Symbol	Test Conditions	Min.	Typ. ^b	Max.	Unit	
Static							
Gate Threshold Voltage	$V_{GS(th)}$	$V_{DS} = V_{GS}, I_D = 250\ \mu\text{A}$	Ch-1	1.0	3.0	V	
			Ch-2	0.8	2.0		
Gate-Body Leakage	I_{GSS}	$V_{DS} = 0\ \text{V}, V_{GS} = \pm 20\ \text{V}$	Ch-1		± 100	nA	
		$V_{DS} = 0\ \text{V}, V_{GS} = \pm 12\ \text{V}$	Ch-2		± 100		
Zero Gate Voltage Drain Current	I_{DSS}	$V_{DS} = 30\ \text{V}, V_{GS} = 0\ \text{V}$	Ch-1		1	μA	
			Ch-2		100		
		$V_{DS} = 30\ \text{V}, V_{GS} = 0\ \text{V}, T_J = 85\text{ }^\circ\text{C}$	Ch-1		15		
			Ch-2		2000		
On-State Drain Current ^b	$I_{D(on)}$	$V_{DS} = 5\ \text{V}, V_{GS} = 10\ \text{V}$	Ch-1	20		A	
			Ch-2	20			
Drain-Source On-State Resistance ^b	$R_{DS(on)}$	$V_{GS} = 10\ \text{V}, I_D = 7.5\ \text{A}$	Ch-1		0.017	0.022	Ω
			Ch-2		0.016	0.022	
		$V_{GS} = 4.5\ \text{V}, I_D = 6.5\ \text{A}$	Ch-1		0.024	0.030	
			Ch-2		0.020	0.028	
Forward Transconductance ^b	g_{fs}	$V_{DS} = 15\ \text{V}, I_D = 7.5\ \text{A}$	Ch-1		19	S	
			Ch-2		21		
Diode Forward Voltage ^b	V_{SD}	$I_S = 1\ \text{A}, V_{GS} = 0\ \text{V}$	Ch-1		0.75	1.2	V
			Ch-2		0.47	0.5	
Dynamic^a							
Total Gate Charge	Q_g	$V_{DS} = 15\ \text{V}, V_{GS} = 4.5\ \text{V}, I_D = 7.5\ \text{A}$	Ch-1		7	11	nC
			Ch-2		11.5	18	
Gate-Source Charge	Q_{gs}	$V_{DS} = 15\ \text{V}, V_{GS} = 4.5\ \text{V}, I_D = 7.5\ \text{A}$	Ch-1		2.9		nC
			Ch-2		3.8		
Gate-Drain Charge	Q_{gd}	$V_{DS} = 15\ \text{V}, V_{GS} = 4.5\ \text{V}, I_D = 7.5\ \text{A}$	Ch-1		2.5		nC
			Ch-2		3.5		
Gate Resistance	R_G	$V_{DS} = 15\ \text{V}, V_{GS} = 4.5\ \text{V}, I_D = 7.5\ \text{A}$	Ch-1		1.5		Ω
			Ch-2		1.8		
Turn-On Delay Time	$t_{d(on)}$	$V_{DD} = 15\ \text{V}, R_L = 15\ \Omega$ $I_D \cong 1\ \text{A}, V_{GEN} = 10\ \text{V}, R_G = 6\ \Omega$	Ch-1		9	15	ns
			Ch-2		12	20	
Rise Time	t_r	$V_{DD} = 15\ \text{V}, R_L = 15\ \Omega$ $I_D \cong 1\ \text{A}, V_{GEN} = 10\ \text{V}, R_G = 6\ \Omega$	Ch-1		10	17	
			Ch-2		10	17	
Turn-Off Delay Time	$t_{d(off)}$	$V_{DD} = 15\ \text{V}, R_L = 15\ \Omega$ $I_D \cong 1\ \text{A}, V_{GEN} = 10\ \text{V}, R_G = 6\ \Omega$	Ch-1		19	30	
			Ch-2		40	66	
Fall Time	t_f	$V_{DD} = 15\ \text{V}, R_L = 15\ \Omega$ $I_D \cong 1\ \text{A}, V_{GEN} = 10\ \text{V}, R_G = 6\ \Omega$	Ch-1		9	15	
			Ch-2		9	15	
Source-Drain Reverse Recovery Time	t_{rr}	$I_F = 1.7\ \text{A}, dI/dt = 100\ \text{A}/\mu\text{s}$	Ch-1		35	55	
			Ch-2		28	45	

Notes:

a. Pulse test; pulse width $\leq 300\ \mu\text{s}$, duty cycle $\leq 2\%$.

b. Guaranteed by design, not subject to production testing.

SCHOTTKY SPECIFICATIONS $T_J = 25\text{ }^\circ\text{C}$, unless otherwise noted						
Parameter	Symbol	Test Conditions	Min.	Typ.	Max.	Unit
Forward Voltage Drop	V_F	$I_F = 1.0\ \text{A}$		0.47	0.50	V
		$I_F = 1.0\ \text{A}, T_J = 125\text{ }^\circ\text{C}$		0.36	0.42	
Maximum Reverse Leakage Current	I_{rm}	$V_r = 30\ \text{V}$		0.004	0.100	mA
		$V_r = 30\ \text{V}, T_J = 100\text{ }^\circ\text{C}$		0.7	10	
		$V_r = -30\ \text{V}, T_J = 125\text{ }^\circ\text{C}$		3.0	20	
Junction Capacitance	C_T	$V_r = 10\ \text{V}$		50		pF

Stresses beyond those listed under "Absolute Maximum Ratings" may cause permanent damage to the device. These are stress ratings only, and functional operation of the device at these or any other conditions beyond those indicated in the operational sections of the specifications is not implied. Exposure to absolute maximum rating conditions for extended periods may affect device reliability.

MOSFET CHANNEL-1 TYPICAL CHARACTERISTICS 25 °C, unless otherwise noted

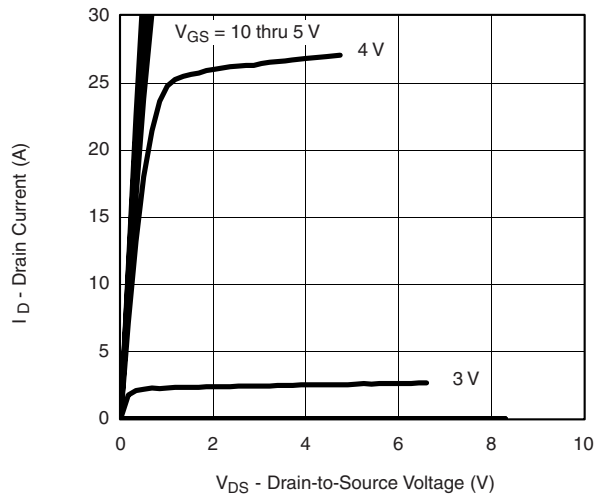

Output Characteristics

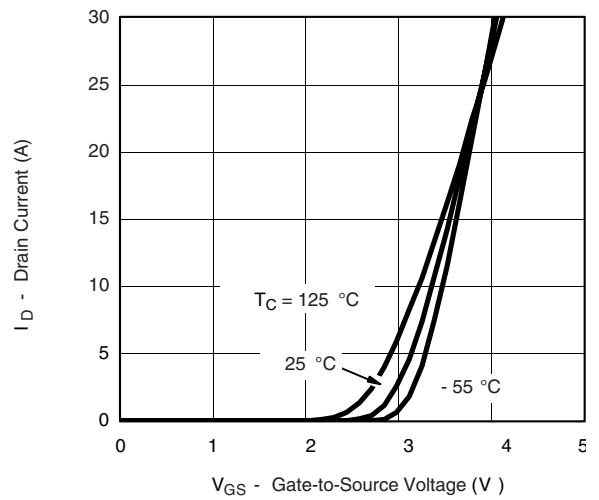

Transfer Characteristics

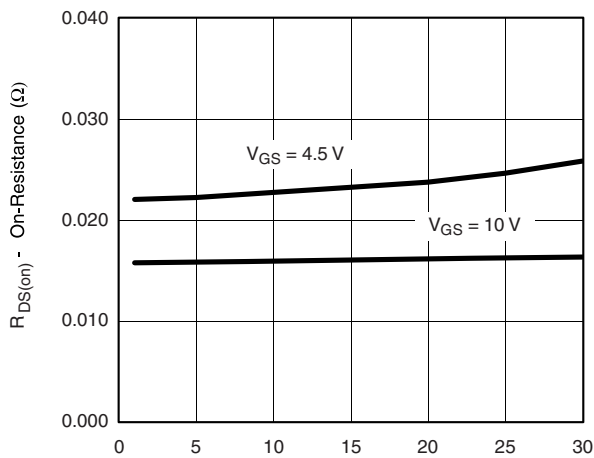

On-Resistance vs. Drain Current

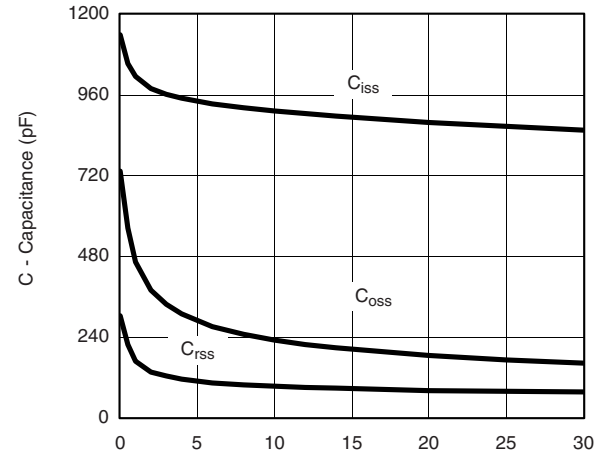

Capacitance

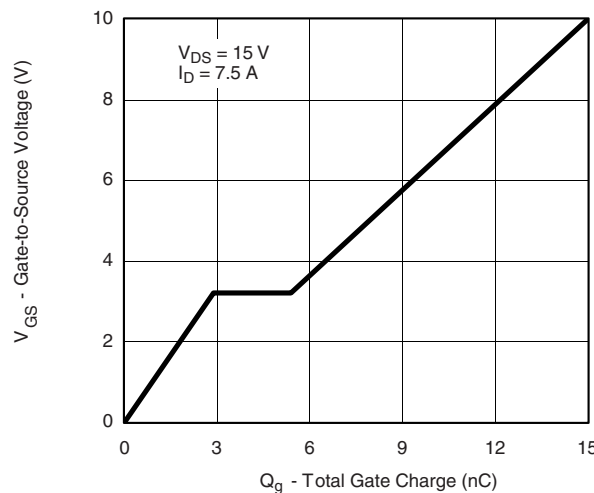

Gate Charge

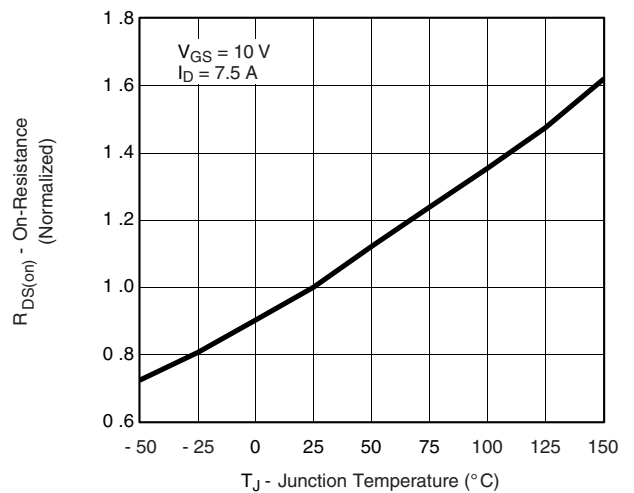

On-Resistance vs. Junction Temperature

MOSFET CHANNEL-1 TYPICAL CHARACTERISTICS 25 °C, unless otherwise noted

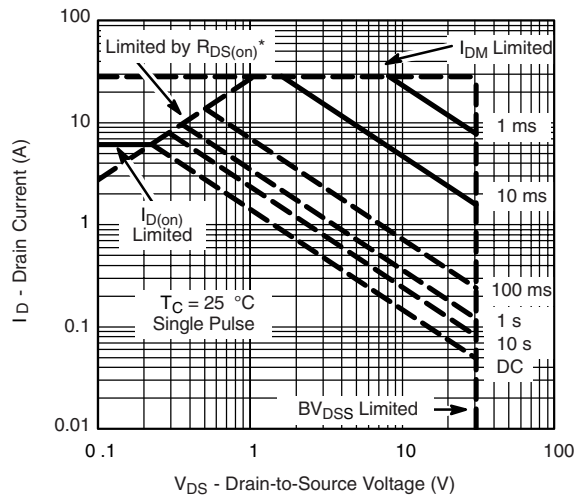
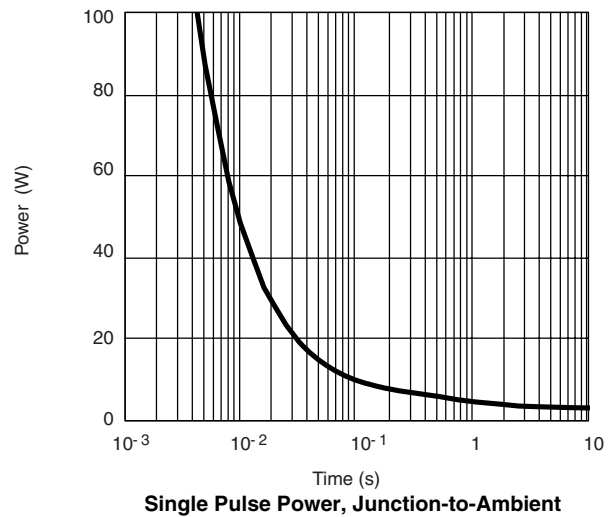
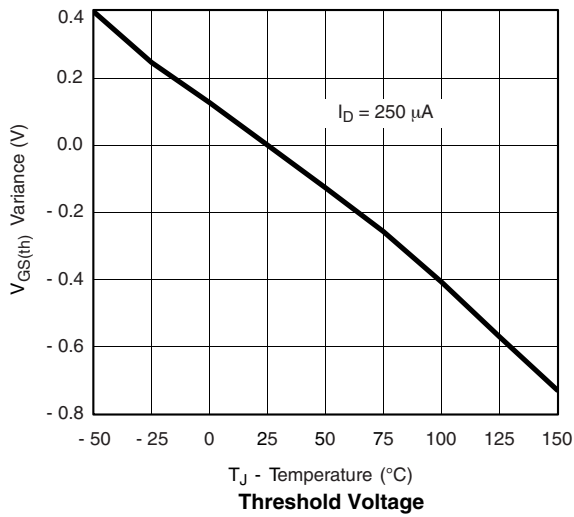
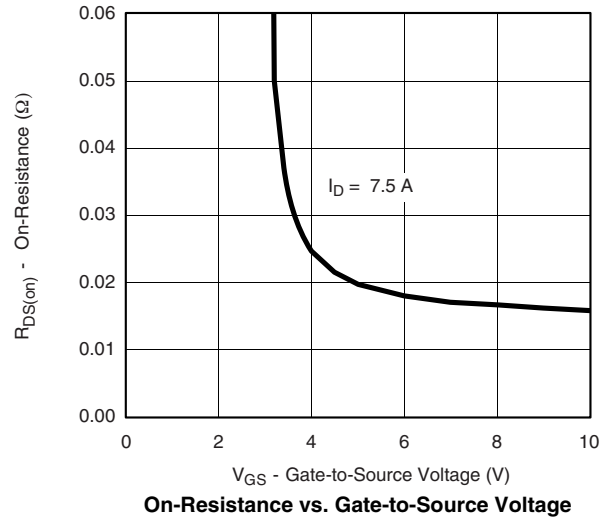
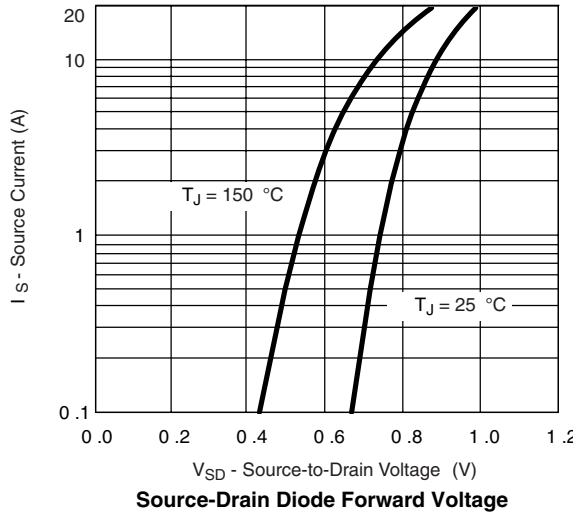

* V_{GS} > minimum V_{GS} at which $R_{DS(on)}$ is specified
Safe Operating Area, Junction-to-Foot

MOSFET CHANNEL-1 TYPICAL CHARACTERISTICS 25 °C, unless otherwise noted

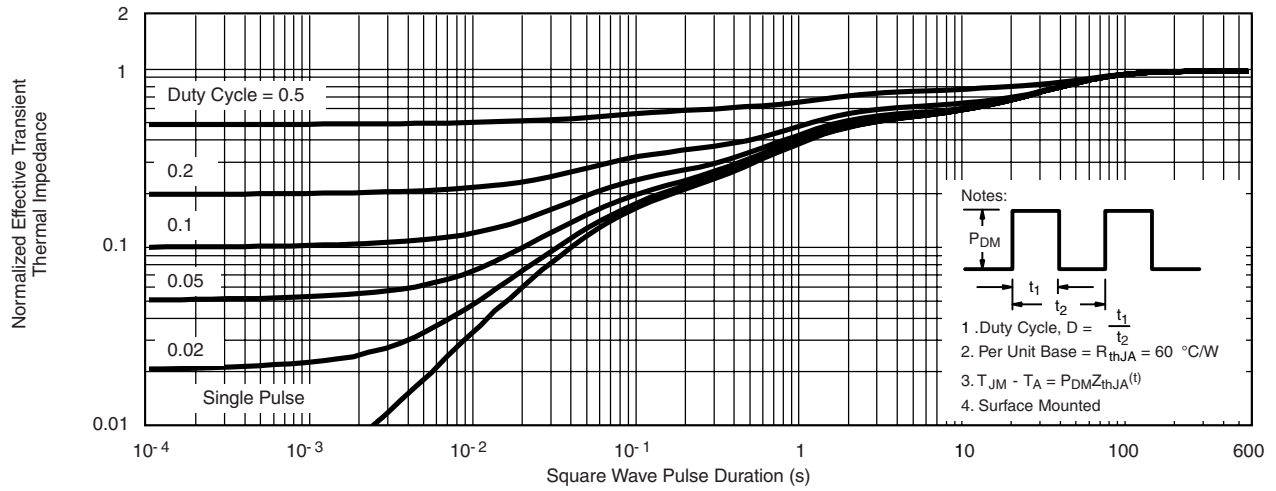

Normalized Thermal Transient Impedance, Junction-to-Ambient

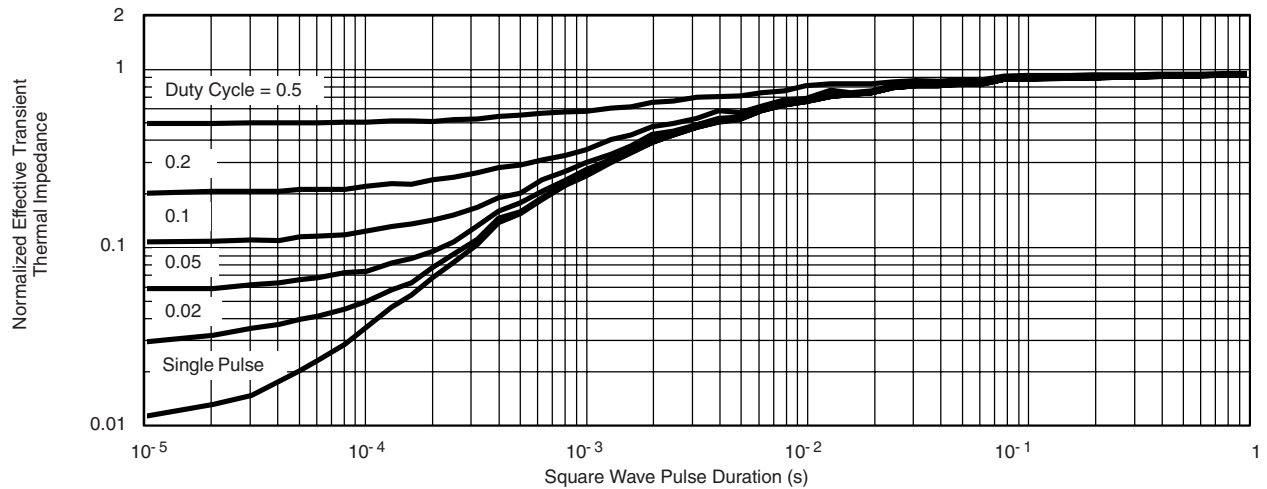

Normalized Thermal Transient Impedance, Junction-to-Case

MOSFET CHANNEL-2 TYPICAL CHARACTERISTICS 25 °C, unless otherwise noted

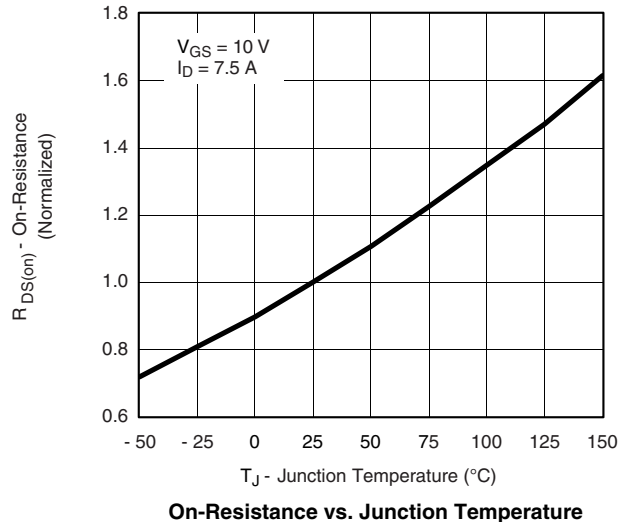
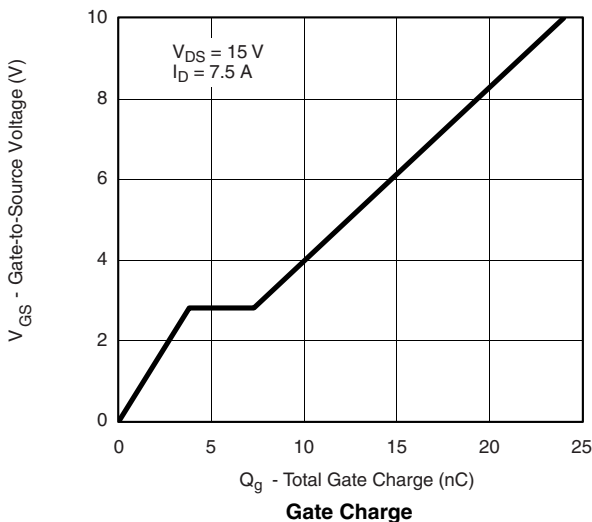
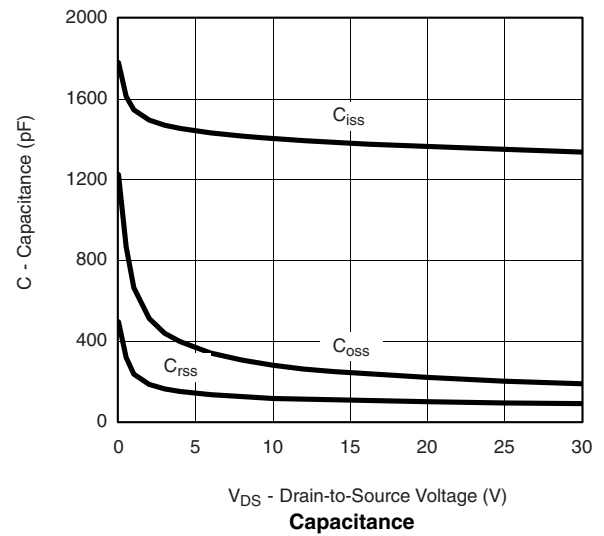
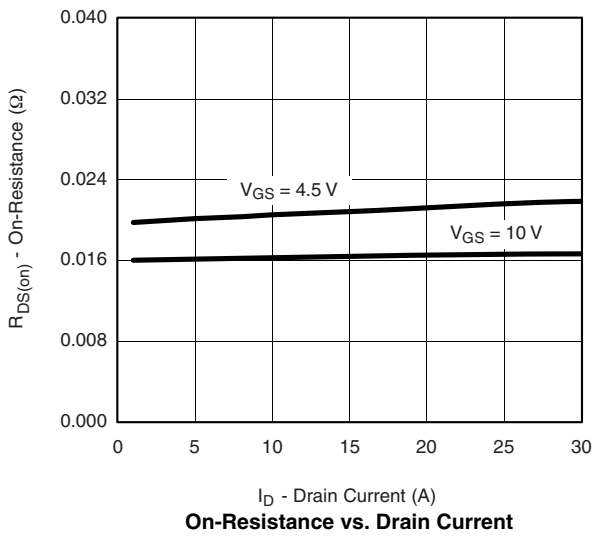
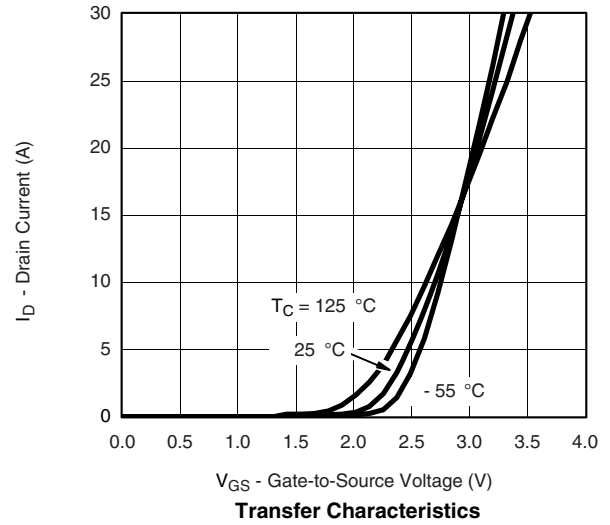
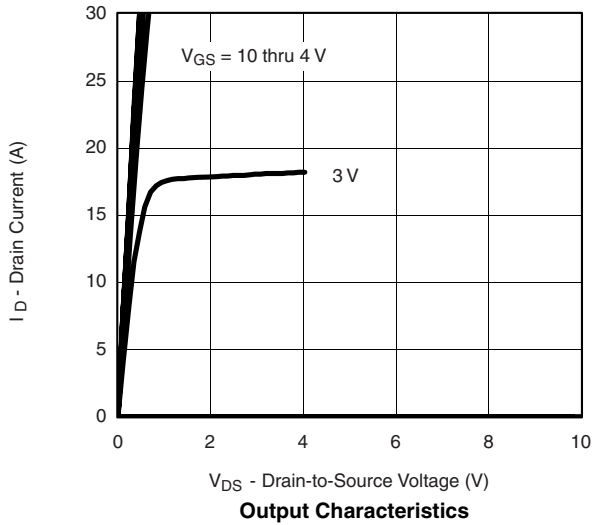

MOSFET CHANNEL-2 TYPICAL CHARACTERISTICS 25 °C, unless otherwise noted

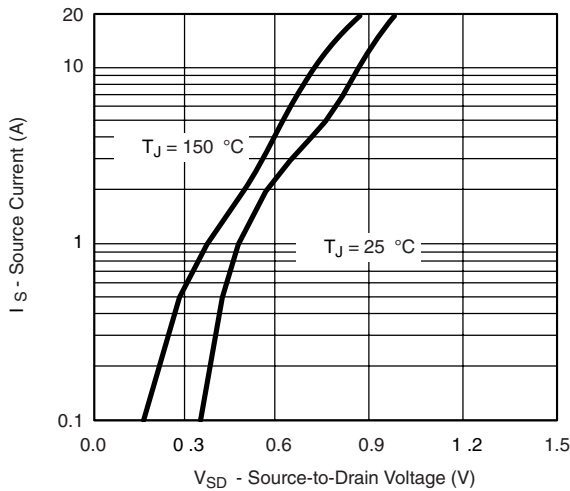

Source-Drain Diode Forward Voltage

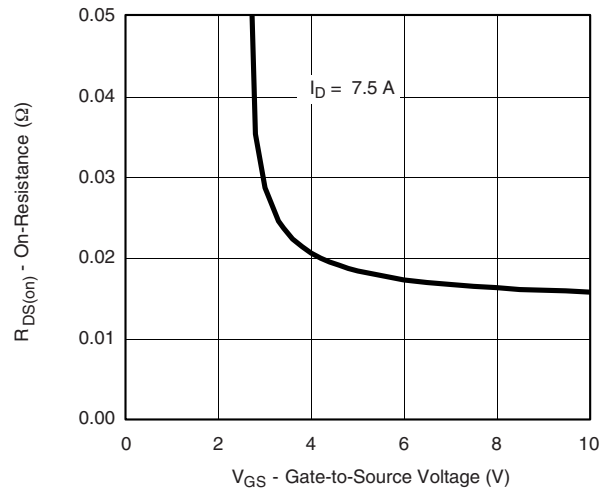

On-Resistance vs. Gate-to-Source Voltage

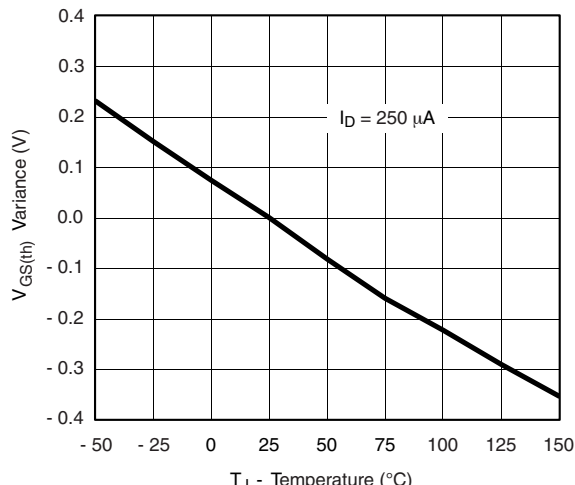

Threshold Voltage

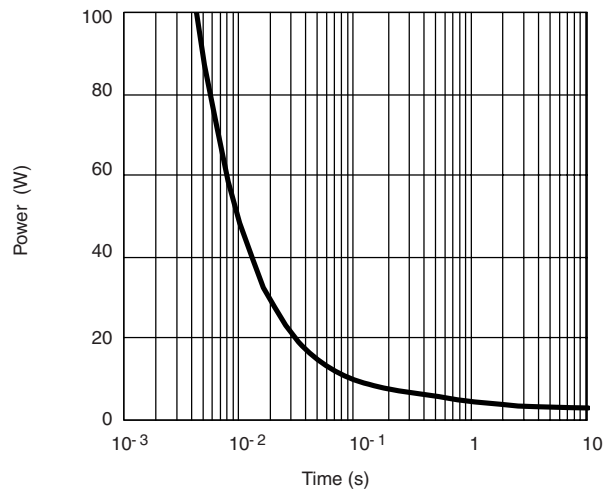

Single Pulse Power, Junction-to-Ambient

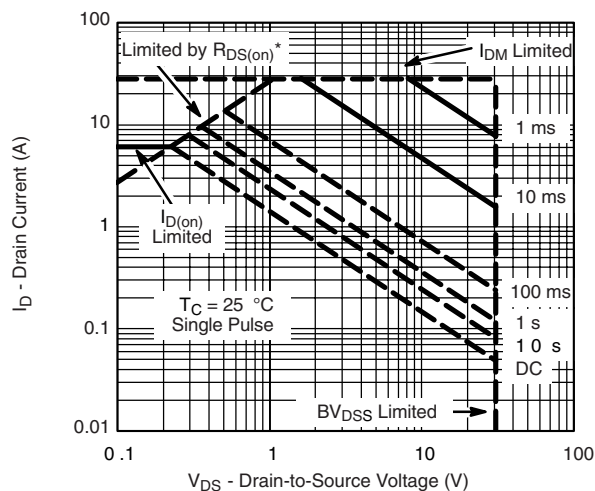

* $V_{GS} >$ minimum V_{GS} at which $R_{DS(on)}$ is specified

Safe Operating Area, Junction-to-Foot

MOSFET CHANNEL-2 TYPICAL CHARACTERISTICS 25 °C, unless otherwise noted

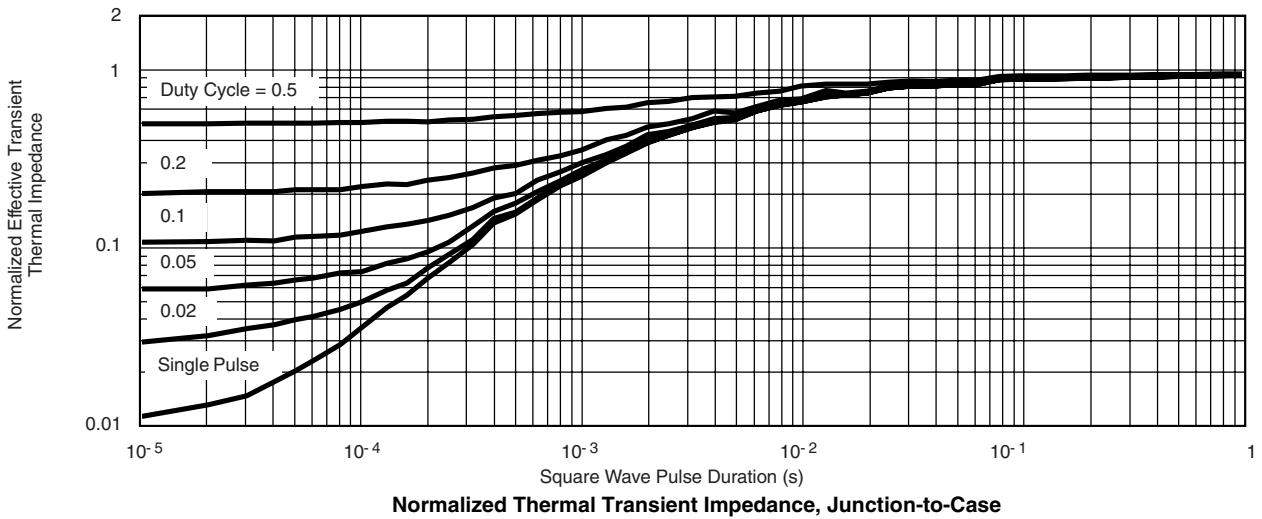
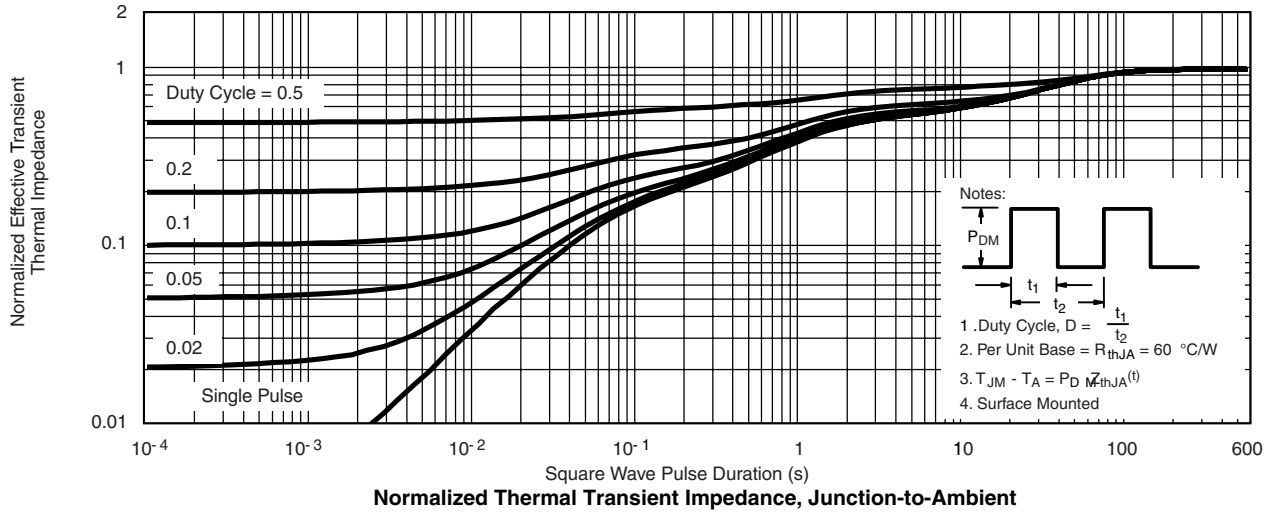

SCHOTTKY TYPICAL CHARACTERISTICS 25 °C, unless otherwise noted

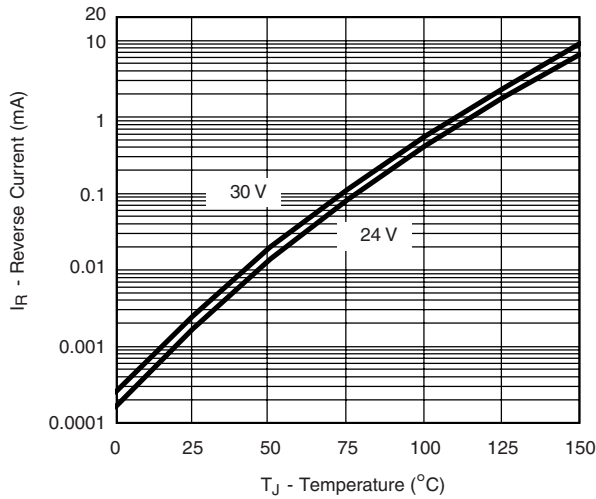

Reverse Current vs. Junction Temperature

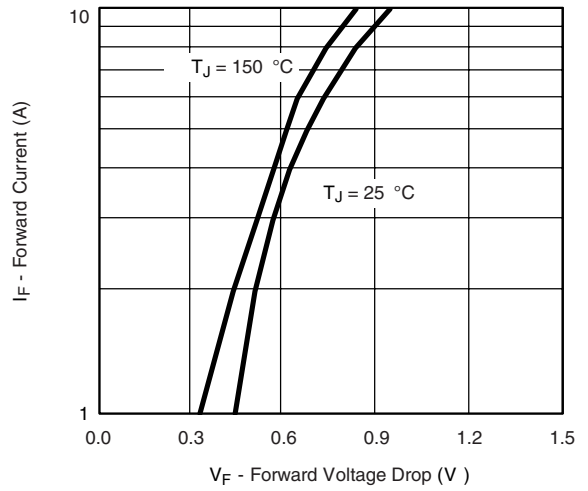

Forward Voltage Drop

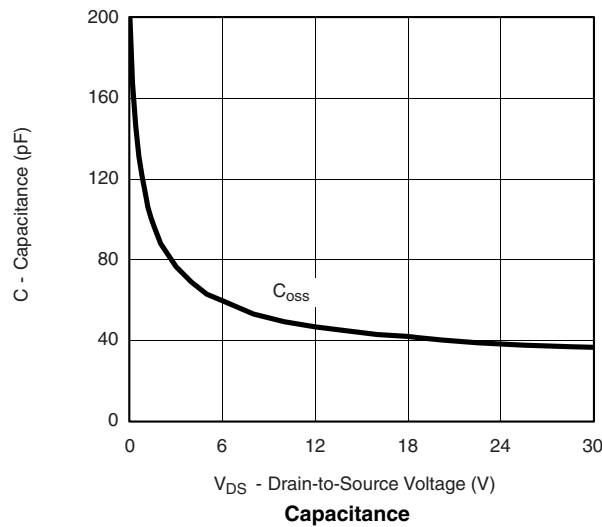

Capacitance

Vishay Siliconix maintains worldwide manufacturing capability. Products may be manufactured at one of several qualified locations. Reliability data for Silicon Technology and Package Reliability represent a composite of all qualified locations. For related documents such as package/tape drawings, part marking, and reliability data, see <http://www.vishay.com/ppg?72035>.



Disclaimer

All product specifications and data are subject to change without notice.

Vishay Intertechnology, Inc., its affiliates, agents, and employees, and all persons acting on its or their behalf (collectively, "Vishay"), disclaim any and all liability for any errors, inaccuracies or incompleteness contained herein or in any other disclosure relating to any product.

Vishay disclaims any and all liability arising out of the use or application of any product described herein or of any information provided herein to the maximum extent permitted by law. The product specifications do not expand or otherwise modify Vishay's terms and conditions of purchase, including but not limited to the warranty expressed therein, which apply to these products.

No license, express or implied, by estoppel or otherwise, to any intellectual property rights is granted by this document or by any conduct of Vishay.

The products shown herein are not designed for use in medical, life-saving, or life-sustaining applications unless otherwise expressly indicated. Customers using or selling Vishay products not expressly indicated for use in such applications do so entirely at their own risk and agree to fully indemnify Vishay for any damages arising or resulting from such use or sale. Please contact authorized Vishay personnel to obtain written terms and conditions regarding products designed for such applications.

Product names and markings noted herein may be trademarks of their respective owners.