

PACKAGE MECHANICAL DATA

DO 4 Metal

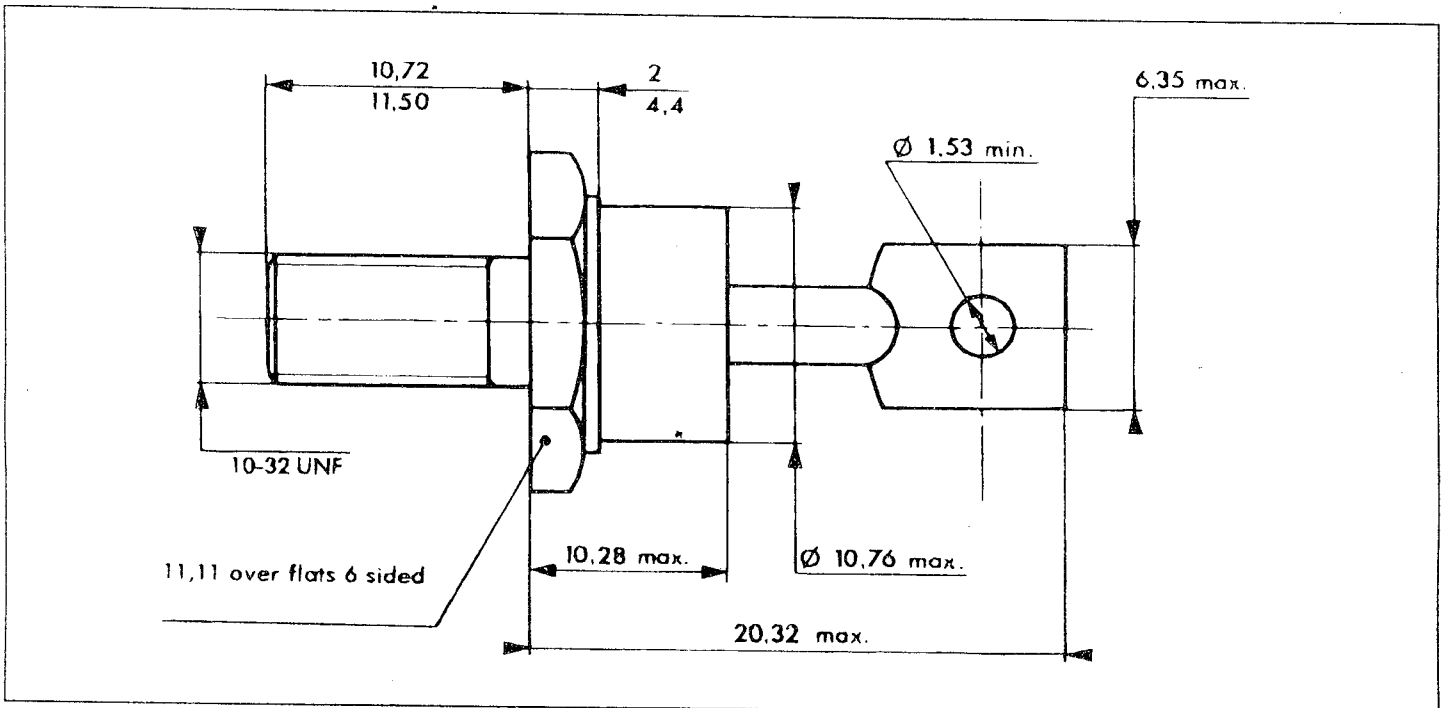

Marking : Cathode connected to case : type number
Anode connected to case : type number + suffix R