

MAX16841 Evaluation Kit

Evaluates: MAX16841

General Description

The MAX16841 evaluation kit (EV kit) demonstrates the MAX16841 LED driver IC used for offline LED lighting applications. The EV kit is configured as a flyback topology to drive 6 to 8 LEDs from a universal AC input supply. The IC is designed for standard offline applications. The typical input power at 230V AC input is 11.7W.

The EV kit is designed to pass EM55015 Class B specifications and EN6100-3-2 for harmonic currents. The EV kit is dimmable with most of the leading- and trailing-edge dimmers.

[Ordering Information](#) appears at end of data sheet.

Features

- ◆ Universal AC Input Operation
- ◆ Drives 6 to 8 Series LEDs
- ◆ 40V Open-LED Protection
- ◆ Demonstrates IC Power-Factor Correction
- ◆ Demonstrates Dimming with Leading- and Trailing-Edge Dimmers
- ◆ Passes EN55015 B Conducted EMI
- ◆ Passes IEC 61000-3-2 Class D Harmonic Current Emissions
- ◆ Proven PCB Layout
- ◆ Fully Assembled and Tested

Component List

DESIGNATION	QTY	DESCRIPTION
AC1, LED+	2	Red test points
AC2, LED-	2	White test points
C1	1	0.022 μ F \pm 10%, 630V film capacitor Panasonic ECQE6223KF
C2	1	47000pF \pm 10%, 50V X7R ceramic capacitor (0805) Murata GRM21BR71H473K
C3	1	0.1 μ F \pm 10%, 400V film capacitor Panasonic ECQE4104KF
C4	1	0.22 μ F \pm 10%, 400V film capacitor Panasonic ECQE4224kF
C5	1	0.01 μ F \pm 10%, 25V X7R ceramic capacitor (0603) TDK C1608X7R1E103K
C6	1	4.7 μ F \pm 20%, 50V X7R ceramic capacitor (1210) TDK C3225X7R1H475M
C7	1	1 μ F \pm 10%, 50V X7R ceramic capacitor (0805) Murata GRM21BR71H105KA
C8, C9	2	470 μ F \pm 20%, 35V electrolytic capacitors (10mm x 16mm) Rubycon 35ZLH470M10x16

DESIGNATION	QTY	DESCRIPTION
C10	1	2200pF \pm 20%, 6.3kV ceramic capacitor Murata DECE33J222ZC4B
C11	1	4.7 μ F \pm 10%, 16V X7R ceramic capacitor (0805) Murata GRM21BR71C475K
C12	1	10 μ F \pm 20%, 25V X7R ceramic capacitor (1210) TDK C3225X7R1E106M
C13	1	0.1 μ F \pm 10%, 25V X7R ceramic capacitor (0603) Murata GRM188R71E104K
C14	1	0.033 μ F \pm 10%, 25V X7R ceramic capacitor (0603) TDK C1608X7R1E333K
C15	1	1000pF \pm 5%, 250V C0G ceramic capacitor (0805) TDK C2012C0G2E102J
C16	0	Not installed, ceramic capacitor (0603)
C17	1	33pF \pm 5%, 50V C0G ceramic capacitor (0603) TDK C1608C0G1H330J
C18	1	22pF \pm 5%, 50V C0G ceramic capacitor (0603) TDK C1608C0G1H220J

MAX16841 Evaluation Kit

Evaluates: MAX16841

Component List (continued)

DESIGNATION	QTY	DESCRIPTION
D1	1	600V, 1A bridge rectifier (DFS) Vishay DF06S-E3/45
D2	1	100V, 3A Schottky diode (SMB) Comchip CDBB3100-G
D3, D7, D9, D12, D13	5	75V, 150mA diodes (SOD323F) Fairchild 1N4148WS
D4, D6	2	400V, 1A rectifier diodes (SMA) Comchip CGRA4004-G
D5	1	150V, 3W zener diode (SMB) ON Semi 1SMB5953BT3G
D8	1	15V, 500mW zener diode (SOD123) Fairchild MMSZ5245B
D10	1	4.8V, 150mW zener diode (SOT523) Diodes Inc. BZX84C5V1T
D11	1	600V, 1A rectifier(SMB) Vishay MURS160-E3/52T
F1	1	250V AC, 1.25A fuse Bel Fuse Inc RST 1.25
L1, L2, L3	3	1000μH inductors Coilcraft LPS6235-105ML
N1	1	600V, 2.4A n-channel MOSFET (DPAK) STMicroelectronics STD3NK60ZT4
N2, N4	2	400V n-channel MOSFETs (SOT223) Fairchild FQT1N60C
Q1	1	35V, 50mA npn dual transistor (SOT363) Central Semi CMKT5088
Q2	1	600V, 800mA thyristor (SOT223) ON Semi MCR08MT1G
R1	1	3Ω ±1%, 1/2W resistor (1206) Susumu RL1632R-3R00-F
R2	1	150Ω ±5%, 3/4W resistor (1812) Panasonic-ECG ERJ-S12J151

DESIGNATION	QTY	DESCRIPTION
R3, R4	2	549kΩ ±1%, 1/4W resistors (1206)
R5	1	100Ω ±5% resistor (0805)
R6, R25	2	1kΩ ±5%, 1/2W resistors (1210)
R7, R8	2	2.1kΩ ±1% resistors (0805)
R9	1	75kΩ ±1%, 1/2W resistor (1210)
R10, R11	2	100kΩ ±1%, 1/4W resistors (1206)
R12	1	33Ω ±5%, 1/2W resistor (1206) Vishay CRCW120633R0JNEAHP
R13	2	1.24MΩ ±1% resistors (0603)
R14	1	22Ω ±5% resistor (0805)
R15, R16	2	604kΩ ±1% resistors (1206)
R17	1	73.2kΩ ±1%, 1/4W resistor (0603)
R18	1	300Ω ±5%, 1W resistor Panasonic-ECG ERG-1SJ301A
R19	1	32.4kΩ ±1% resistor (0603)
R20	1	20.5kΩ ±1% resistor (0603)
R21, R26	2	12.1kΩ ±1% resistors (0603)
R22	1	68.1kΩ ±1% resistor (0805)
R23	1	430V transient/surge absorber Panasonic ERZV10D431
R24	1	0Ω ±5% resistor (0603)
R27, R28	2	332kΩ ±1%, 1/4W resistors (1206)
R29	1	78.7kΩ ±1% resistor (0603)
R30	1	22kΩ ±5% resistor (0603)
R31	1	150kΩ ±5% resistor (0603)
T1	1	350mA, 1.17:6.84:4.19:1 transformer Würth 750815148
U1	1	Dimmable offline LED lamps controller (8 SO) Maxim MAX16841ASA+
—	1	PCB: MAX16841 EVALUATION KIT

MAX16841 Evaluation Kit

Evaluates: MAX16841

Component Suppliers

SUPPLIER	PHONE	WEBSITE
Bel Fuse Inc.	201-432-0463	www.belfuse.com
Central Semiconductor Corp.	631-435-1110	www.centralsemi.com
Coilcraft, Inc.	847-639-6400	www.coilcraft.com
Diodes Incorporated	805-446-4800	www.diodes.com
Fairchild Semiconductor	888-522-5372	www.fairchildsemi.com
Murata Electronics North America, Inc.	770-436-1300	www.murata-northamerica.com
ON Semiconductor	602-244-6600	www.onsemi.com
Panasonic Corp.	800-344-2112	www.panasonic.com
Rubycon Corp.	408-467-3864	www.rubycon.com
Susumu International USA	208-328-0307	www.susumu-usa.com
TDK Corp.	847-803-6100	www.component.tdk.com
Vishay	402-563-6866	www.vishay.com
Würth Elektronik GmbH & Co. KG	201-785-8800	www.we-online.com

Note: Indicate you are using the MAX16841 when contacting these component suppliers.

Quick Start

Required Equipment

- MAX16841 EV kit
- 85V to 264V AC source
- 6 to 8 series-connected LED strings rated no less than 500mA
- Current probe to measure the LED current (the LED should be illuminated)

Procedures

The EV kit is fully assembled and tested. Follow the steps below to verify board operation. **Caution: Do not turn on the power supply until all connections are completed.**

- 1) Connect the AC source to the AC1 and AC2 test points.
- 2) Connect the LED string anode and cathode to the LED+ and LED- test points, respectively.
- 3) Clip the current probe across the LED+ wire to measure the LED current.
- 4) Enable the power supply.
- 5) Measure the LED current using the current probe.

Detailed Description of Hardware

The MAX16841 EV kit demonstrates the MAX16841 LED driver IC. The device is an average current-mode control HB LED driver IC for buck and flyback topologies in offline LED lamp applications. The IC uses a proprietary input current-control scheme to achieve power-factor correction. The IC's LED driver uses constant-frequency, aver-

age current-mode control to control the duty cycle of the external switching MOSFET (N1). The IC is available in an 8-pin SO package.

The EV kit circuit is configured in a flyback topology and provides up to 10W of output power for a string of 8 series LEDs connected at the LED+ and LED- test points. The converter switching frequency is set at 70kHz. The EV kit circuit operates from an AC supply voltage of 90V_{RMS} to 265V_{RMS}. The EV kit is designed on a proven 2oz copper, two-layer small PCB footprint design. The EV kit is optimized for operation in the 180V_{RMS} to 265V_{RMS} range.

The IC uses average current-mode control, with the circuit configured such that the average current flowing into the current-sense resistor (R1) on a cycle-by-cycle (switching frequency) basis is set by the voltage on the REFI pin. The average current per switching cycle flowing into R1 is as follows:

$$I_{av} = \frac{V_{REFI} - 0.1V}{5 \times R1}$$

where V_{REFI} is in volts, R1 is in ohms, and I_{av} is in amps.

Circuit components L1, L2, L3, and C1 provide EMI filtering. During the turn-on instant of the triac dimmer, there would be significant ringing due to high inrush current to charge the input capacitor, C3. The ringing can cause the line current to fall to zero and turn off the dimmer. Components R2, R6, and C4 function as a damper and help to limit the inrush current and ringing. Resistor R2 is bypassed by Q1 after approximately 55µs of dimming instant, thereby reducing power dissipation in R2 and improving efficiency. Diode D4 provides fast discharge of C2 during off instant of the dimmer.

MAX16841 Evaluation Kit

Evaluates: MAX16841

Capacitor C3 provides a path for the input switching-frequency currents for the flyback converter. Maximum value of this capacitor is limited by the input power-factor requirement. The greater the value of C3, the lower the input power factor. Electrolytic capacitors C8 and C9 filter the double-line frequency ripple in the LED current. During startup, bias for the IC comes from the linear regulator circuit formed by N2, R10, R11, and D8. During running condition, bias comes from the auxiliary winding of the flyback transformer (T1).

Resistors R15, R16, and R17 program the switching threshold of the flyback converter. The rising threshold is set at 22V input voltage. When the line voltage is at an instant below V_{TH} falling threshold, DIMOUT drives MOSFET N4 on and resistor R18 connects across the diode-bridge positive and GND. This load ensures that there is a closed-circuit path for the timing circuit of the triac in the external dimmer. The flyback converter starts switching again when the line voltage is at an instant above the V_{TH} rising threshold. At the same time, DIMOUT goes low and the resistor is disconnected.

Diode D6 blocks capacitors C3 and C4 to discharge through R18 during the off-time of dimming.

Circuit components R27, R28, R29, D13, R13, C6, Q1, R21, and R26 are used to set the reference for the input current. Transistor Q1 is a pair of matched transistors. The voltage information on C6 is used to control the current in the current-mirror circuit formed by R13, R21, R26, and Q1. The current flowing into R13 is approximately proportional to the voltage across C6 and gets reflected on collector Q1A and sinks the same amount of current from collector Q1B as that flows into R13. The IC has a $50\mu A$ current source at the REFI pin. The current flowing into R19 sets the input current or the average current flowing into R1. The circuit tries to keep the input power over the line voltage almost constant. Circuit components R30, C11, D10, D12, and R31 affect the input current reference during dimming and a wide dimming range is accomplished.

During an open-LED condition, the output voltage increases and this increase in voltage is reflected on the auxiliary winding side; therefore, the IC's IN voltage increases. Once IN voltage exceeds 22.5V (typ), switching stops and the energy transfer from primary to secondary side is stopped. Switching restarts when IN goes below 22V (typ).

EV Kit Dimming Waveforms and Performance Using 8 LEDs

The EV kit was tested with 8 LEDs for dimmer compatibility. Table 1 list the dimmers tested using the EV kit.

Table 1. Recommended Dimmers Tested on EV Kit

DIMMER
Busch-Jaeger 6513-102
Busch-Jaeger 9250
Busch-Jaeger GER 2247
Busch 2250
Busch 6519
Berker 2875
Berker 2874
Berker 2873
Merten 5724
Berker 2885
Berker 2875
Lutron GLS09-C02889
ABB STD50-3
Clipsal 32E450LM
Clipsal 32E450UDM
Clipsal 32E450TM

MAX16841 Evaluation Kit

Evaluates: MAX16841

Figures 1–6 depict waveforms when the EV kit is powered at different input voltages with 8 LEDs connected at LED+ and LED-.

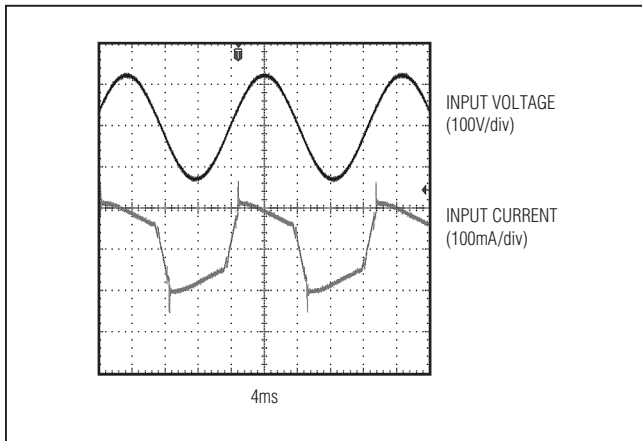

Figure 1. Input Voltage and Current at 90V Input

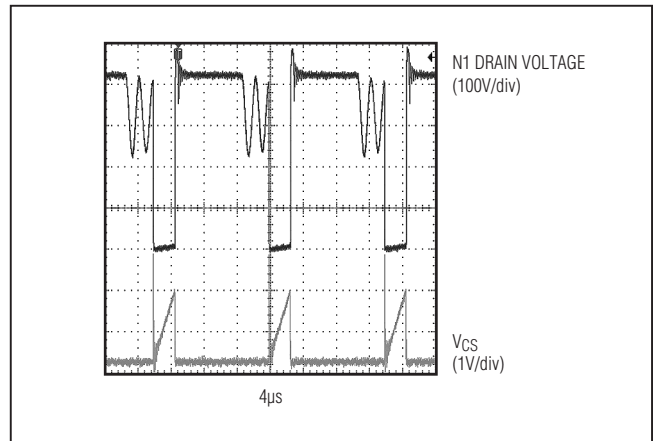

Figure 4. Switching Waveforms at 230V Input

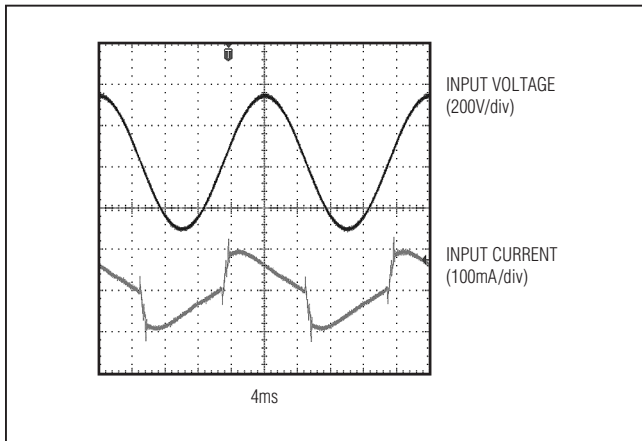

Figure 2. Input Voltage and Current at 230V Input

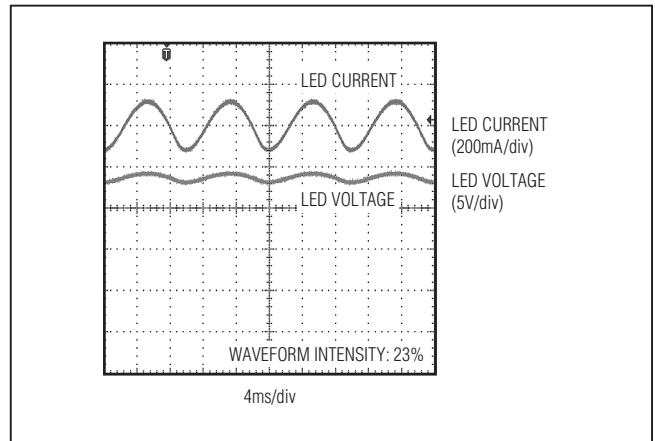

Figure 5. LED Voltage and Current at 230V Input

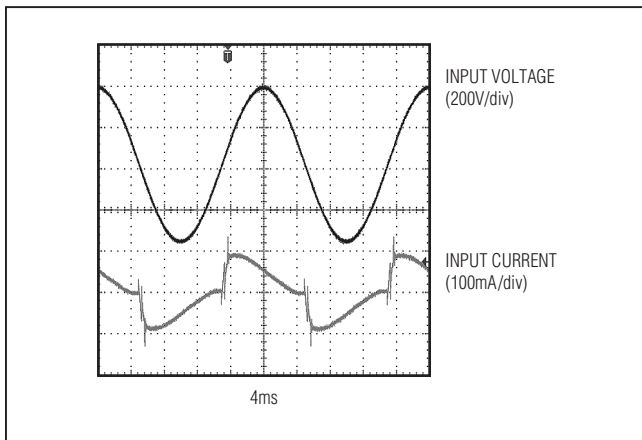

Figure 3. Input Voltage and Current at 265V Input

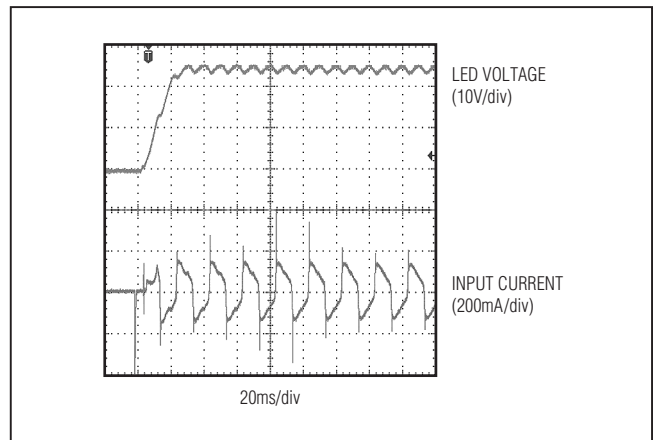

Figure 6. LED Voltage and Input Current During Startup

MAX16841 Evaluation Kit

Evaluates: MAX16841

Figures 7, 8, and 9 depict the EV kit dimming performance current waveforms using the Busch 2250 (leading-edge) dimmer.

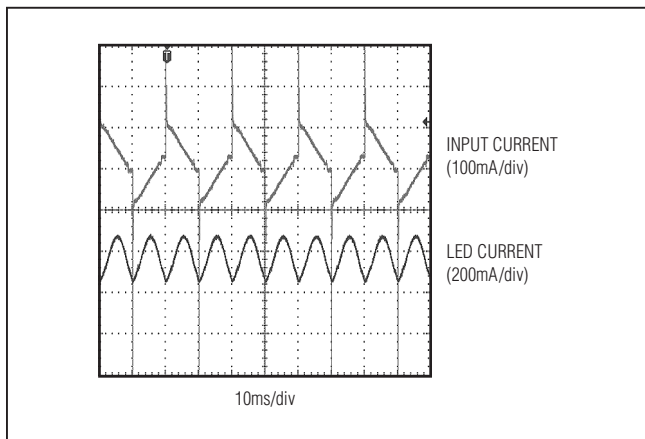

Figure 7. Dimmer At 100% Dimming Using Busch 2250

Figures 10, 11, and 12 depict the EV kit dimming performance waveforms using the Busch 6519 (trailing-edge) dimmer.

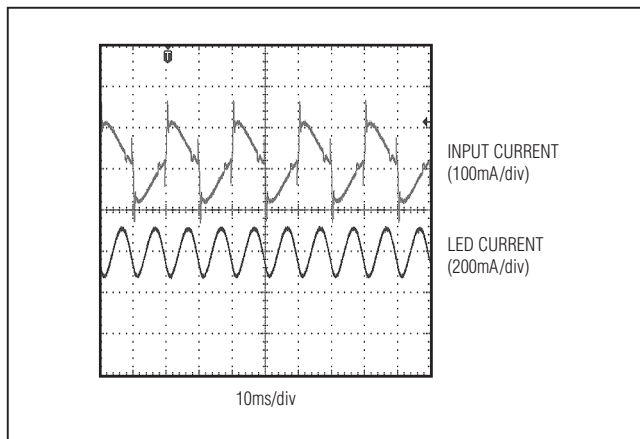

Figure 10. Dimmer at 100% Dimming Using Busch 6519

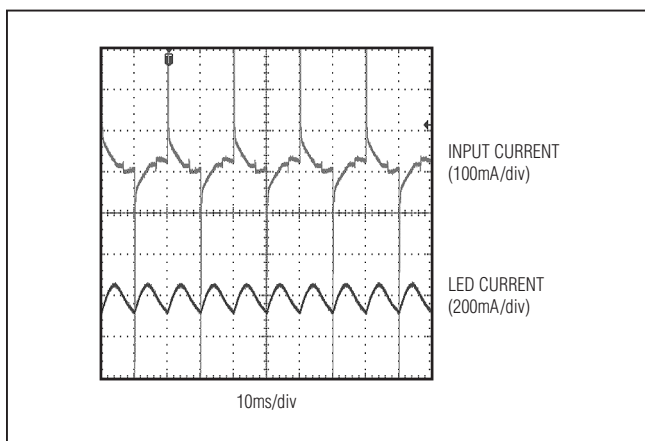

Figure 8. Dimmer at 50% Dimming Using Busch 2250

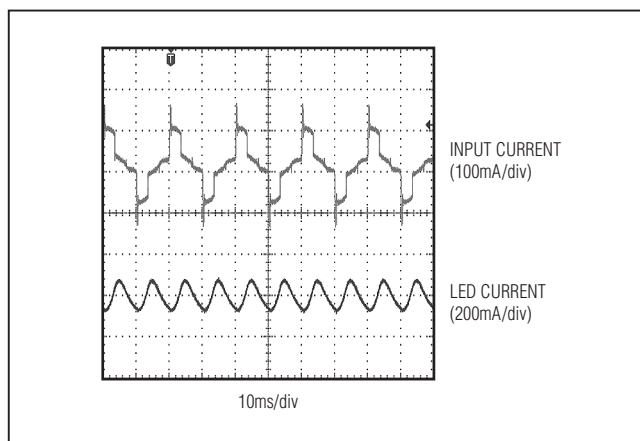

Figure 11. Dimmer at 50% Dimming Using Busch 6519

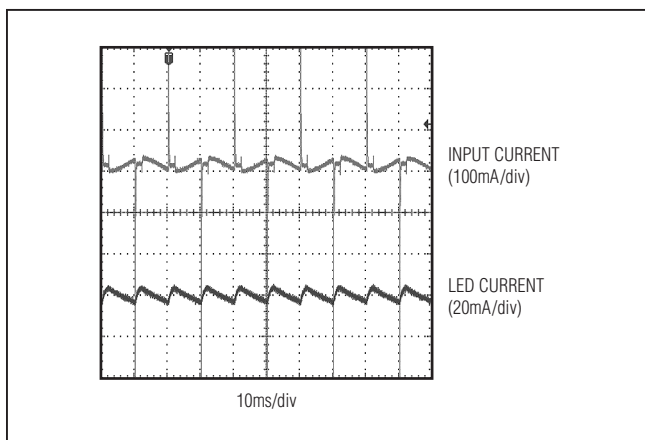

Figure 9. Dimmer at Very Low Dimming Using Busch 2250

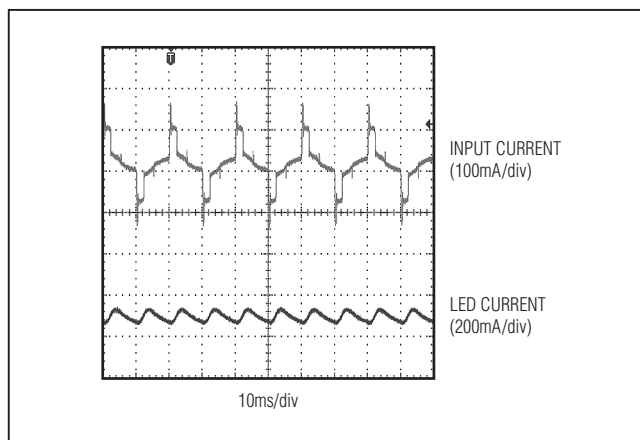

Figure 12. Dimmer at Very Low Dimming Using Busch 6519

MAX16841 Evaluation Kit

Evaluates: MAX16841

Figures 13, 14, and 15 depict the EV kit dimming performance waveforms using the ABB STD 50-3 dimmer.

Table 2 lists the performance results of the EV kit with 8 series LEDs connected at the LED+ and LED- PCB pads.

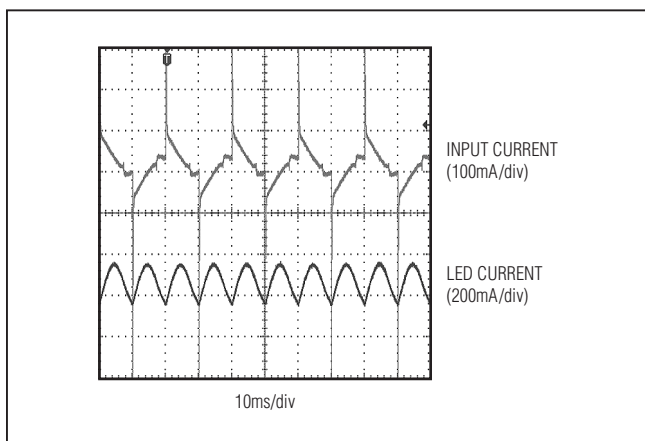

Figure 13. Dimmer at 100% Dimming Using ABB STD50-3

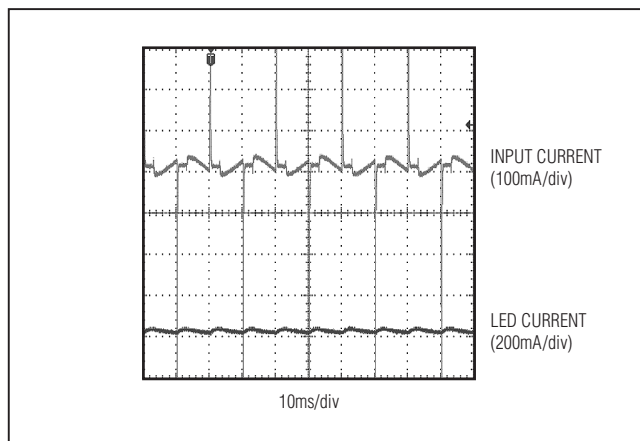

Figure 15. Dimmer at Very Low Dimming Using ABB STD50-3

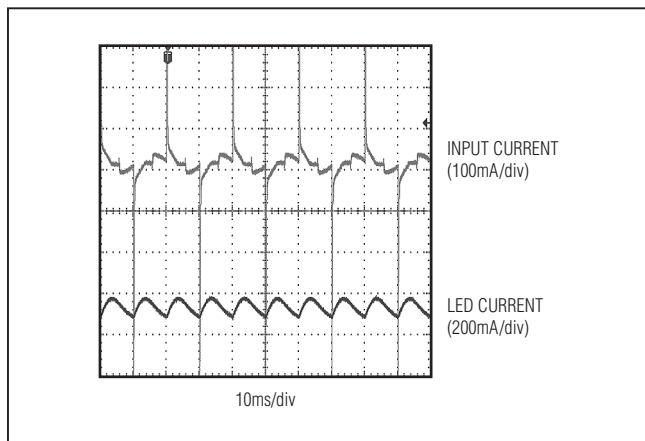

Figure 14. Dimmer at 50% Dimming Using ABB STD50-3

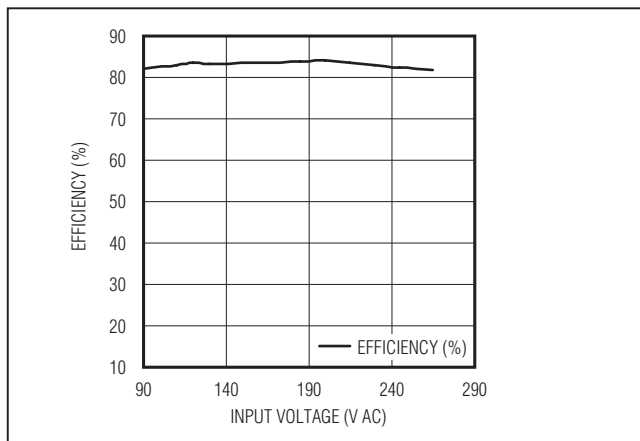

Figure 16. Efficiency vs. Line Voltage

Table 2. Performance Data with 8 Series LEDs

FREQUENCY (Hz)	VIN (V)	PIN (W)	I _{LED} (mA)	V _{LED} (V)	POUT (W)	EFFICIENCY (%)	POWER FACTOR
60	90	6.84	248	22.6	5.61	82	0.948
60	110	8.03	291	22.8	6.68	83.1	0.94
60	120	8.57	312	22.9	7.17	83.6	0.935
60	130	9.08	329	23	7.58	83.4	0.93
50	185	11.05	398	23.3	9.28	83.9	0.895
50	200	11.42	410	23.3	9.6	84	0.883
50	215	11.69	419	23.3	9.77	83.5	0.87
50	230	11.9	422	23.3	9.87	82.9	0.854
50	245	12	424	23.3	9.89	82.4	0.835
50	265	11.97	419	23.3	9.78	81.7	0.809

MAX16841 Evaluation Kit

Evaluates: MAX16841

EMI Testing

A precompliance-conducted emissions test was done with EN55015 B limits with the results viewable in Figures 17a, 17b, and 17c.

Harmonic Data

The EV kit passes IEC 61000-3-2 Class D limits. Figure 18 shows the current harmonics profile at 230V, 50Hz input, and 8 LEDs at output.

Configuring the EV Kit for Nondimming Applications

The EV kit can be modified for nondimming applications. To configure the EV kit for nondimming applications, see Figure 24 and perform the following steps:

- Remove all components shown in blocks 1–4 (i.e., C2, C4, C11; D4, D10, D12; R3–R6, R18, R25, R30, R31; N4, Q2)
- Short components R2 and D6

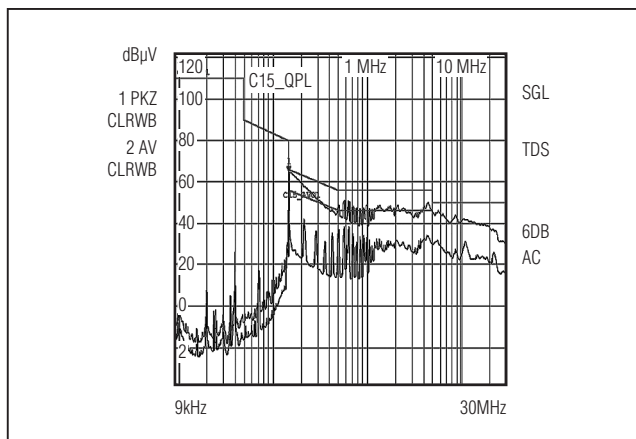

Figure 17a. Conductance Disturbance Test Data (8 LEDs)

EDIT PEAK LIST (Final Measurement Results)			
Trace1:	C15_QP1		
Trace2:	C15_AVG1		
Trace3:	---		
TRACE	FREQUENCY	LEVEL dBµV	DELTA LIMIT dB
1 Quasi Peak	646 kHz	50.22 N	-5.77
2 Average	574 kHz	40.07 N	-5.92
2 Average	646 kHz	39.44 N	-6.55
1 Quasi Peak	582 kHz	48.97 N	-7.02
2 Average	502 kHz	38.27 N	-7.72
1 Quasi Peak	1.022 MHz	46.58 N	-9.42
1 Quasi Peak	730 kHz	46.28 N	-9.71
1 Quasi Peak	862 kHz	46.07 N	-9.92
2 Average	214 kHz	43.03 N	-10.01
2 Average	150 kHz	45.25 N	-10.74
1 Quasi Peak	774 kHz	43.94 N	-12.05
2 Average	286 kHz	37.99 N	-12.65

Figure 17b. EMI Test Data (Part 1)

MAX16841 Evaluation Kit

Evaluates: MAX16841

EDIT PEAK LIST (Final Measurement Results)					
Trace1:	C15_QP1				
Trace2:	C15_AVG1				
Trace3:	---				
TRACE		FREQUENCY	LEVEL dBμV		DELTA LIMIT dB
1	Quasi Peak	646 kHz	49.03 L1		-6.96
1	Quasi Peak	150 kHz	58.57 L1		-7.42
2	Average	574 kHz	38.31 L1		-7.68
2	Average	646 kHz	38.05 L1		-7.94
1	Quasi Peak	586 kHz	47.54 L1		-8.45
2	Average	506 kHz	36.72 L1		-9.27
1	Quasi Peak	4.534 MHz	46.37 L1		-9.62
1	Quasi Peak	498 kHz	45.58 L1		-10.44
2	Average	150 kHz	45.42 L1		-10.57
2	Average	218 kHz	41.05 L1		-11.83
1	Quasi Peak	878 kHz	43.84 L1		-12.15

Figure 17c. EMI Test Data (Part 2)

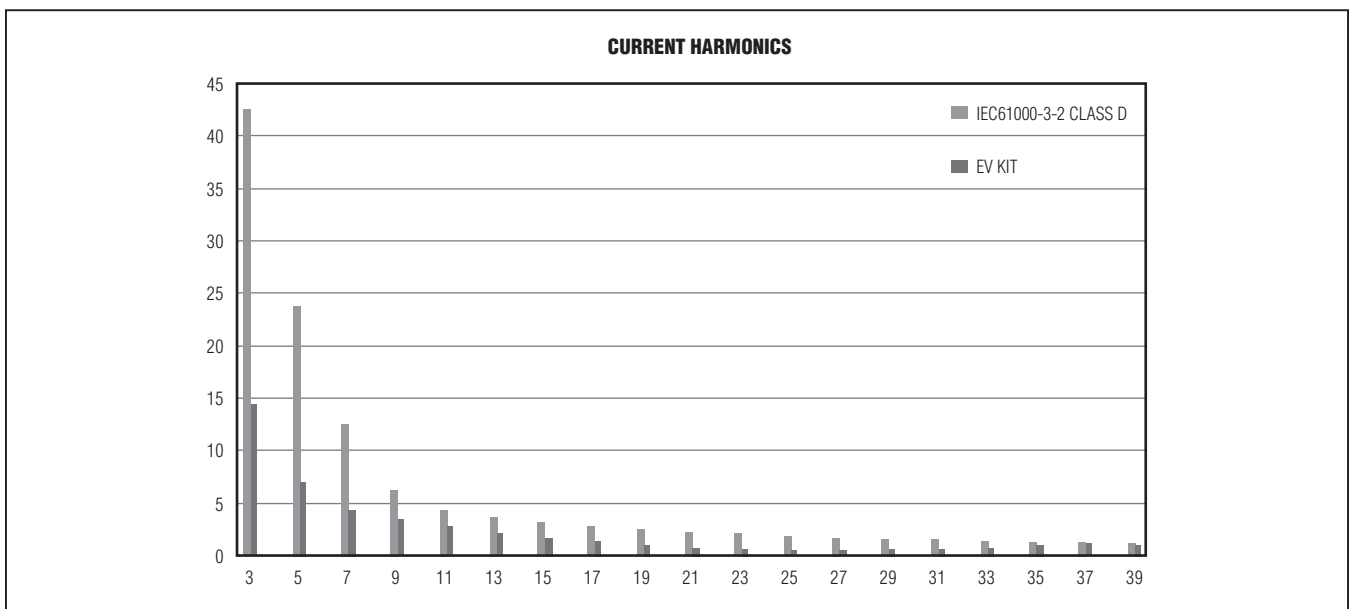

Figure 18. Input Line Current Harmonics

MAX16841 Evaluation Kit

Evaluates: MAX16841

Figures 19–23 depict the EV kit performance when modified for nondimming operations.

Table 3 shows the performance data when the EV kit is configured for nondimming applications. Figure 22 illustrates the EV kit efficiency performance during non-dimming operations.

Harmonic Data Results

The EV kit passes IEC 61000-3-2 Class D limits (see Figure 23). The harmonic data was recorded without the dimming circuit.

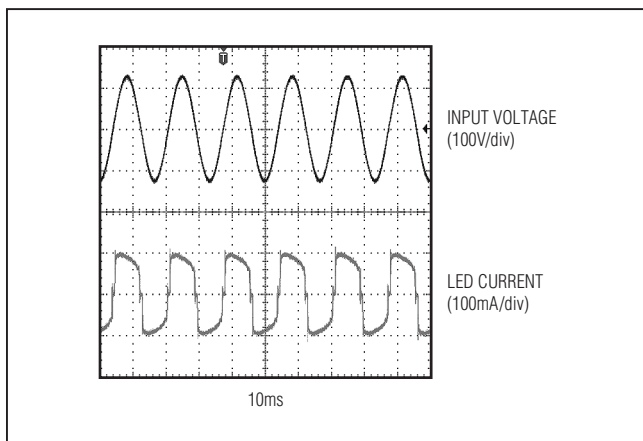

Figure 19. Waveform at 90V, 60Hz Input (Nondimming)

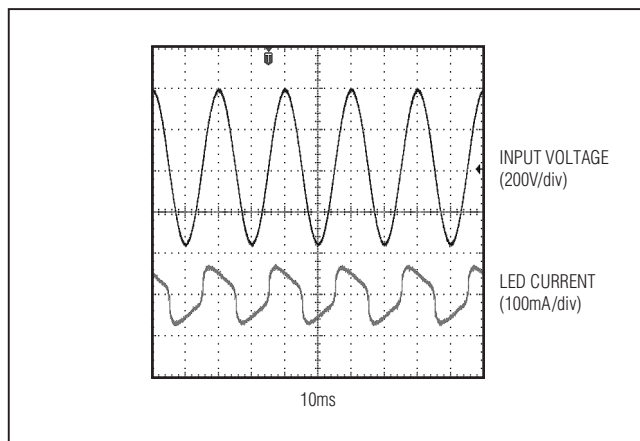

Figure 21. Waveform at 265V, 50Hz Input (Nondimming)

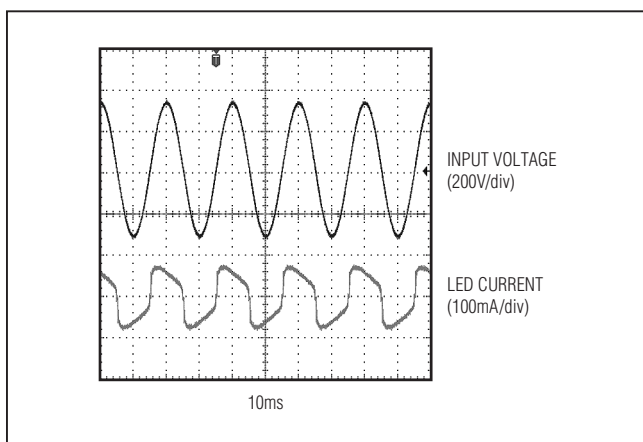

Figure 20. Waveform at 230V, 50Hz Input (Nondimming)

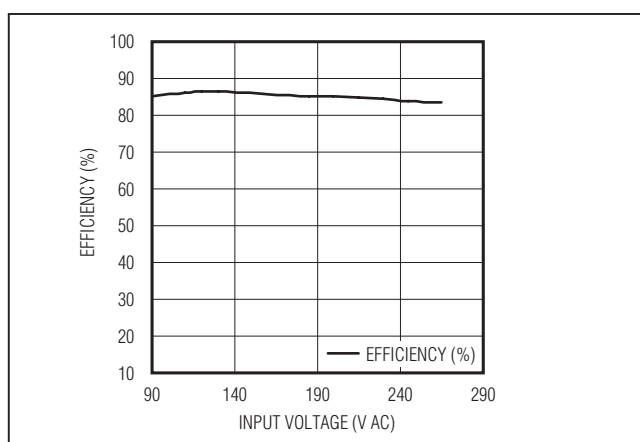

Figure 22. Efficiency vs. Line Voltage (Nondimming)

Table 3. EV Kit Performance without Dimming

FREQUENCY (Hz)	V _{IN} (V)	P _{IN} (W)	I _{LED} (mA)	V _{LED} (V)	P _{OUT} (W)	EFFICIENCY (%)	POWER FACTOR
60	90	6.86	251	23.2	5.84	85.1	0.956
60	110	8.0	296	23.2	6.89	86.1	0.952
60	120	8.54	316	23.3	7.39	86.5	0.949
60	130	8.99	333	23.3	7.78	86.5	0.945
50	185	11.06	402	23.3	9.43	85.3	0.935
50	200	11.36	414	23.4	9.69	85.3	0.934
50	215	11.64	421	23.4	9.87	84.8	0.931
50	230	11.8	427	23.4	9.98	84.6	0.926
50	245	11.87	425	23.4	9.96	83.9	0.92
50	265	11.82	422	23.4	9.88	83.6	0.912

MAX16841 Evaluation Kit

Evaluates: MAX16841

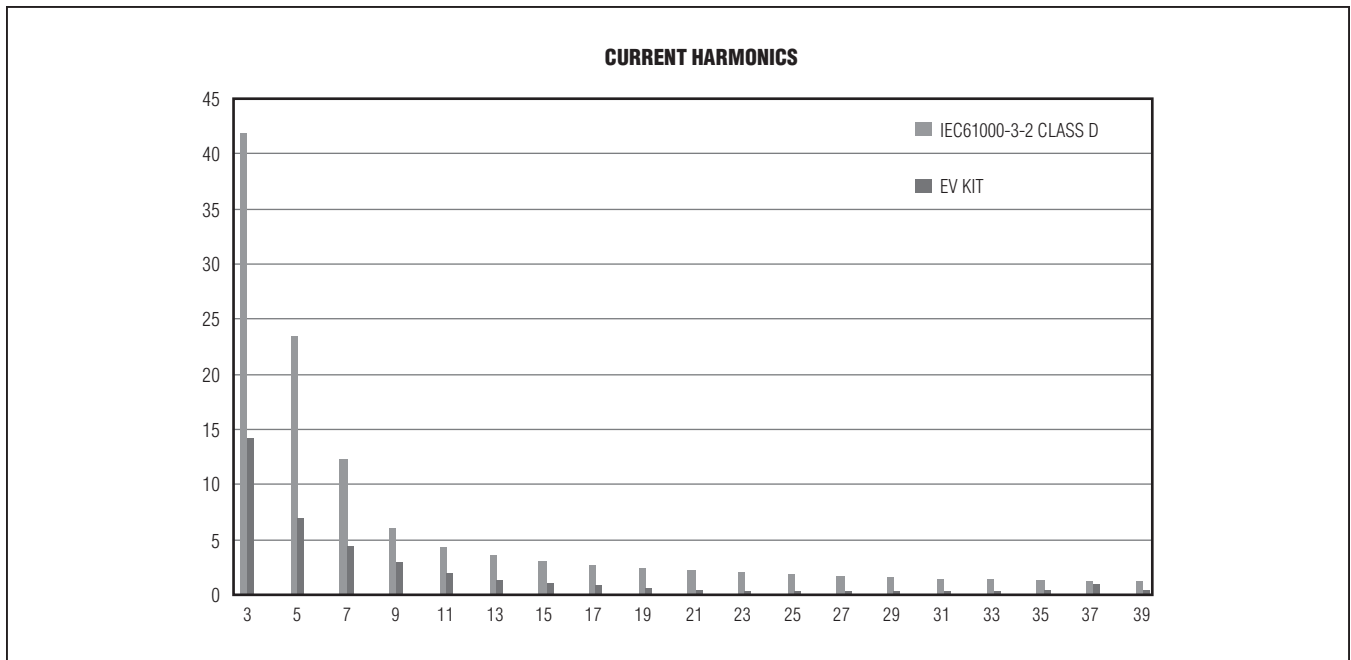

Figure 23. Input Line Current-Harmonics Profile at 230V, 50Hz Input, and 8 LEDs at Output

MAX16841 Evaluation Kit

Evaluates: MAX16841

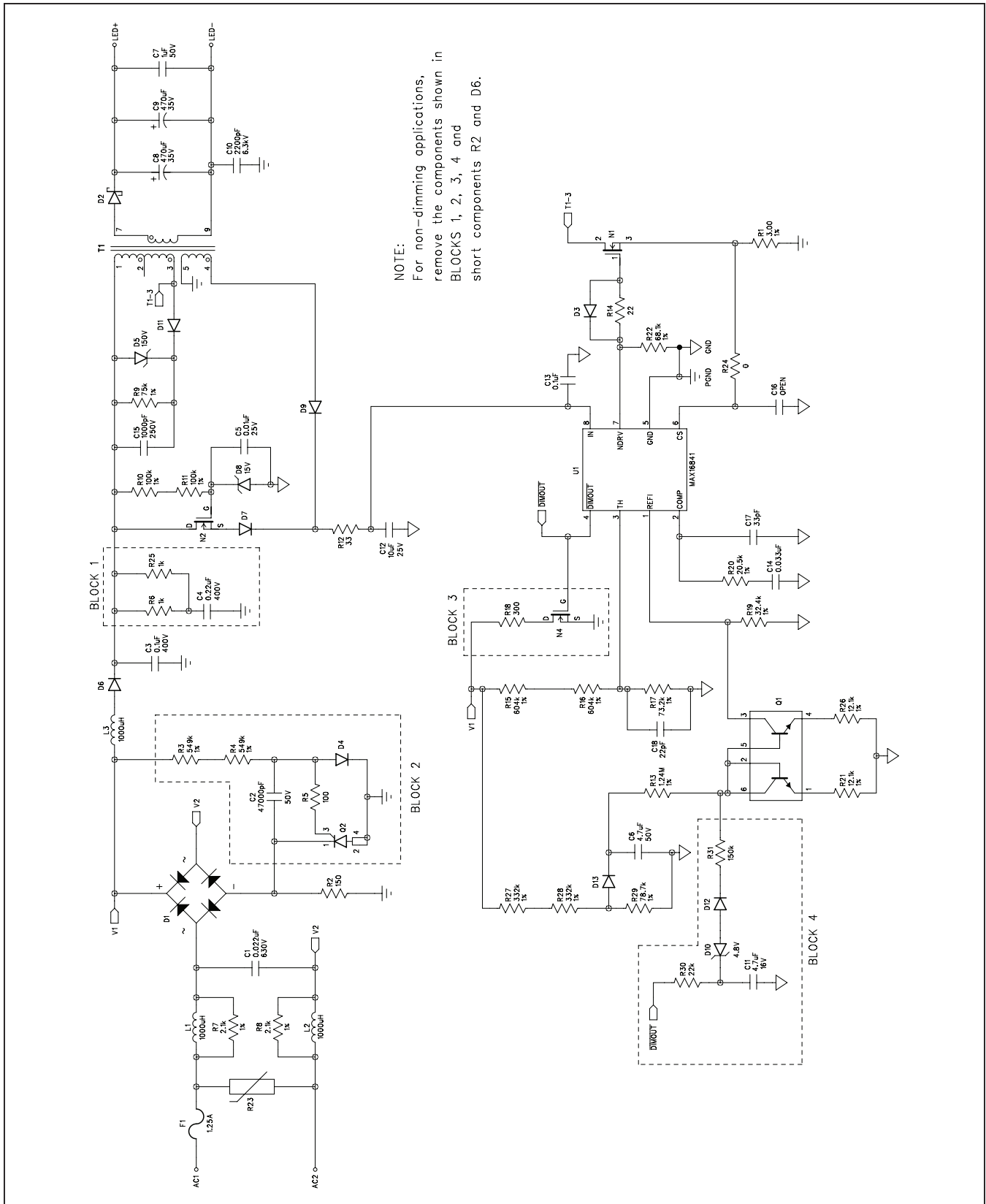

Figure 24. MAX16841 Circuit for Nondimming Applications

MAX16841 Evaluation Kit

Evaluates: MAX16841

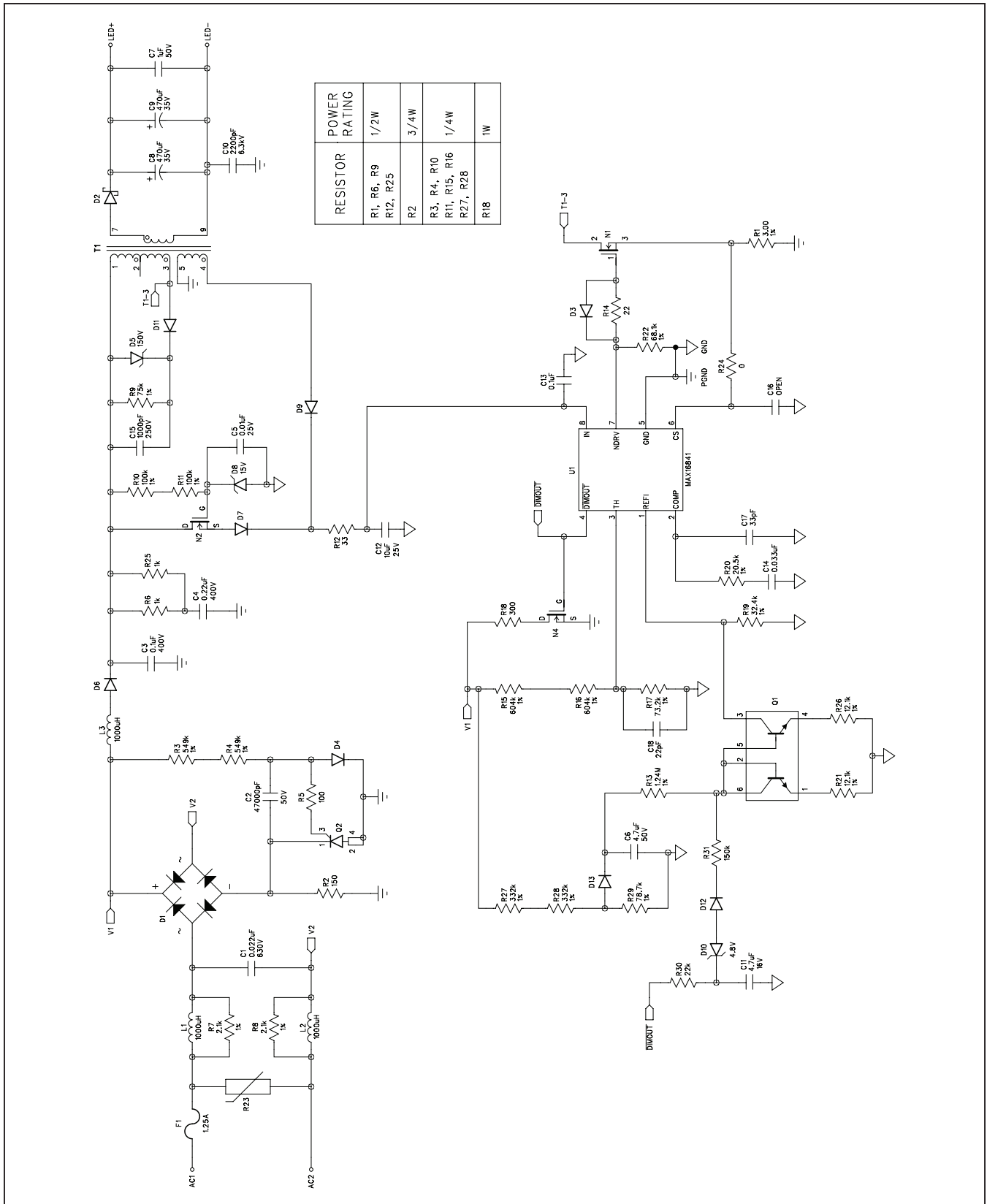

Figure 25. MAX16841 EV Kit Schematic

MAX16841 Evaluation Kit

Evaluates: MAX16841

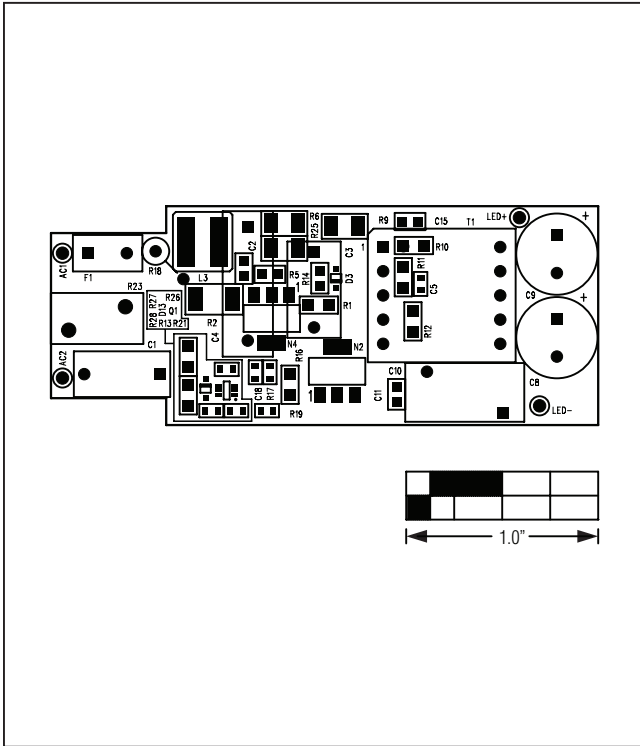

Figure 26. MAX16841 EV Kit Component Placement Guide—Component Side

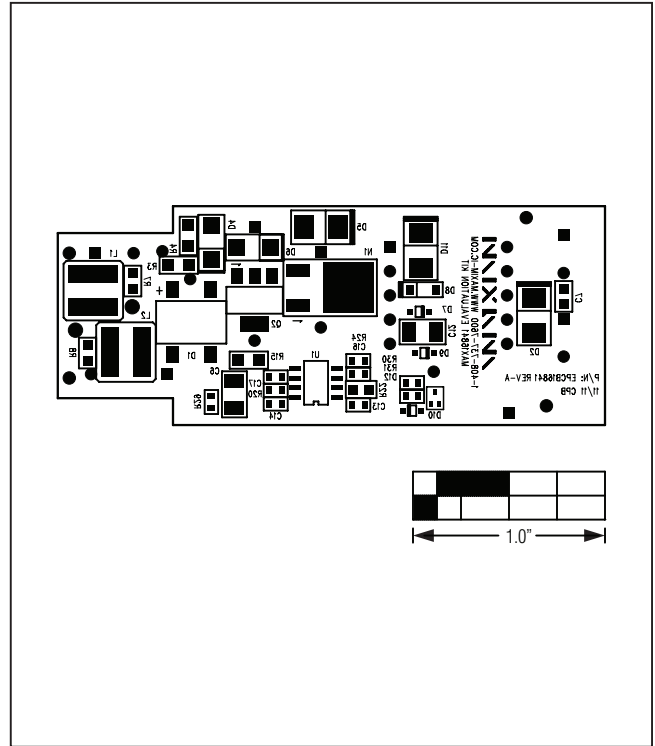

Figure 28. MAX16841 EV Kit Component Placement Guide—Solder Side

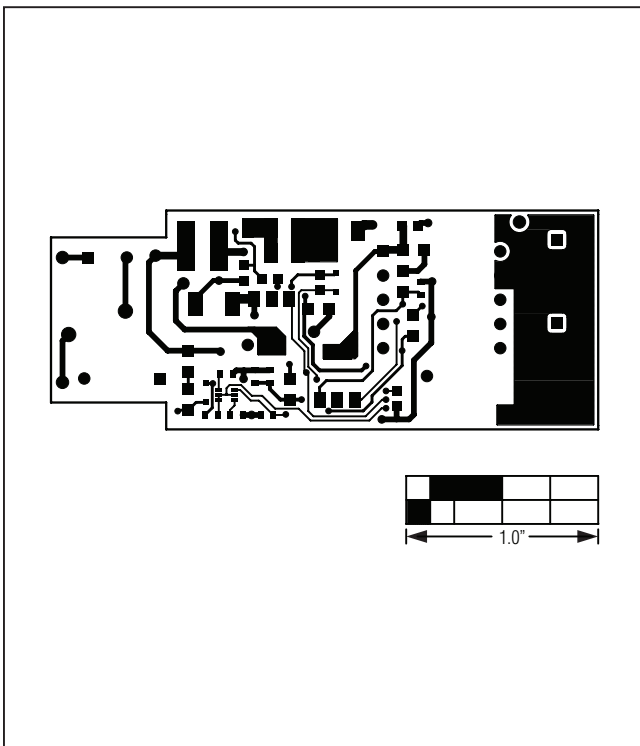

Figure 27. MAX16841 EV Kit PCB Layout—Component Side

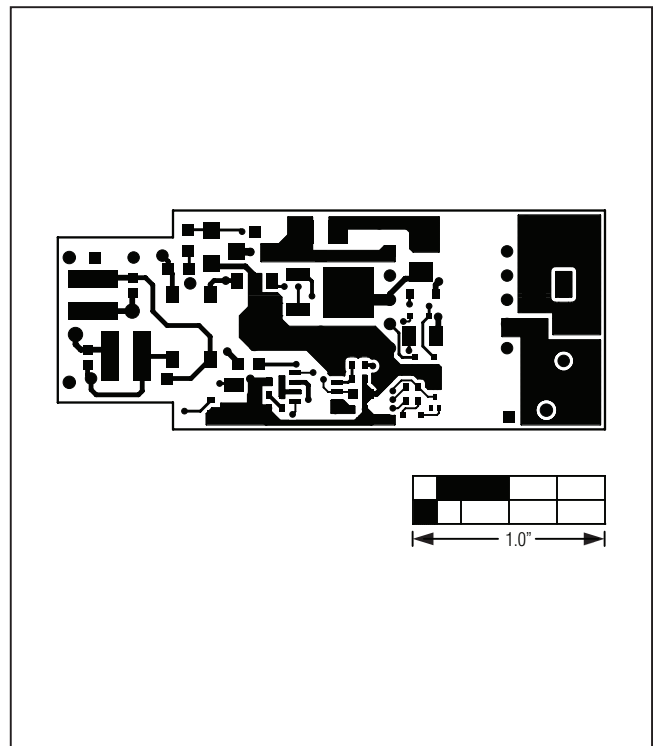

Figure 29. MAX16841 EV Kit PCB Layout—Solder Side

MAX16841 Evaluation Kit

Evaluates: MAX16841

Ordering Information

PART	TYPE
MAX16841EVKIT#	EV Kit

#Denotes RoHS compliant.

MAX16841 Evaluation Kit

Evaluates: MAX16841

Revision History

REVISION NUMBER	REVISION DATE	DESCRIPTION	PAGES CHANGED
0	2/12	Initial release	—

Maxim cannot assume responsibility for use of any circuitry other than circuitry entirely embodied in a Maxim product. No circuit patent licenses are implied. Maxim reserves the right to change the circuitry and specifications without notice at any time.

Maxim Integrated Products, 120 San Gabriel Drive, Sunnyvale, CA 94086 408-737-7600 _____ 16