

MCH6421

Power MOSFET 20V, 38mΩ, 5.5A, Single N-Channel

This Power MOSFET is produced using ON Semiconductor's trench technology, which is specifically designed to minimize gate charge and low on resistance. This device is suitable for applications with low gate charge driving or low on resistance requirements.

Features

- Low On-Resistance
- 1.8V drive
- High Speed Switching
- ESD Diode-Protected Gate
- Pb-Free and RoHS compliance
- Halogen Free compliance : MCH6421-TL-W

Typical Applications

- Load Switch
- Synchronous Boost Converter

SPECIFICATIONS

ABSOLUTE MAXIMUM RATING at Ta = 25°C (Note 1)

Parameter	Symbol	Value	Unit
Drain to Source Voltage	V _{DSS}	20	V
Gate to Source Voltage	V _{GSS}	±12	V
Drain Current (DC)	I _D	5.5	A
Drain Current (Pulse) PW ≤ 10μs, duty cycle ≤ 1%	I _{DP}	22	A
Power Dissipation When mounted on ceramic substrate (1200mm ² × 0.8mm)	P _D	1.5	W
Junction Temperature	T _j	150	°C
Storage Temperature	T _{stg}	-55 to +150	°C

Note 1 : Stresses exceeding those listed in the Maximum Ratings table may damage the device. If any of these limits are exceeded, device functionality should not be assumed, damage may occur and reliability may be affected.

THERMAL RESISTANCE RATINGS

Parameter	Symbol	Value	Unit
Junction to Ambient When mounted on ceramic substrate (1200mm ² × 0.8mm)	R _{θJA}	83.3	°C/W



ON Semiconductor®

www.onsemi.com

V _{DSS}	R _{DS(on)} Max	I _D Max
20V	38mΩ@ 4.5V	5.5A
	61mΩ@ 2.5V	
	99mΩ@ 1.8V	

ELECTRICAL CONNECTION N-Channel

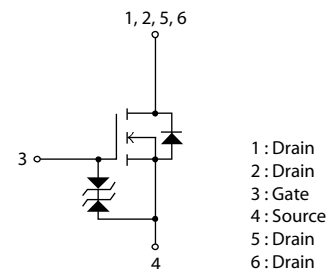

PACKING TYPE : TL

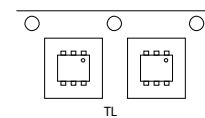

MARKING

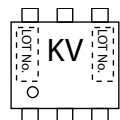

ORDERING INFORMATION

See detailed ordering and shipping information on page 5 of this data sheet.

MCH6421

ELECTRICAL CHARACTERISTICS at Ta = 25°C (Note 2)

Parameter	Symbol	Conditions	Value			Unit
			min	typ	max	
Drain to Source Breakdown Voltage	V(BR)DSS	I _D =1mA, V _{GS} =0V	20			V
Zero-Gate Voltage Drain Current	I _{DSS}	V _{DS} =20V, V _{GS} =0V			1	μA
Gate to Source Leakage Current	I _{GSS}	V _{GS} =±8V, V _{DS} =0V			±10	μA
Gate Threshold Voltage	V _{GS(th)}	V _{DS} =10V, I _D =1mA	0.4		1.3	V
Forward Transconductance	g _{FS}	V _{DS} =10V, I _D =2A	2.0	3.8		S
Static Drain to Source On-State Resistance	R _{DS(on)1}	I _D =2A, V _{GS} =4.5V		29	38	mΩ
	R _{DS(on)2}	I _D =1A, V _{GS} =2.5V		43	61	mΩ
	R _{DS(on)3}	I _D =0.5A, V _{GS} =1.8V		69	99	mΩ
Input Capacitance	C _{iss}	V _{DS} =10V, f=1MHz		410		pF
Output Capacitance	C _{oss}			84		pF
Reverse Transfer Capacitance	C _{rss}			59		pF
Turn-ON Delay Time	t _{d(on)}		See specified Test Circuit		7.5	
Rise Time	t _r			26		ns
Turn-OFF Delay Time	t _{d(off)}			38		ns
Fall Time	t _f			32		ns
Total Gate Charge	Q _g	V _{DS} =10V, V _{GS} =4.5V, I _D =5.5A			5.1	
Gate to Source Charge	Q _{gs}			0.7		nC
Gate to Drain "Miller" Charge	Q _{gd}			1.7		nC
Forward Diode Voltage	V _{SD}	I _S =5.5A, V _{GS} =0V		0.8	1.2	V

Note 2 : Product parametric performance is indicated in the Electrical Characteristics for the listed test conditions, unless otherwise noted. Product performance may not be indicated by the Electrical Characteristics if operated under different conditions.

Switching Time Test Circuit

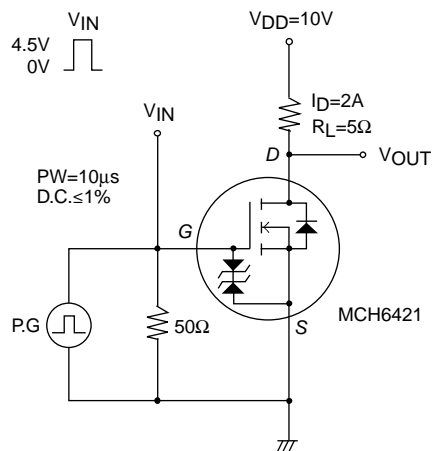

MCH6421

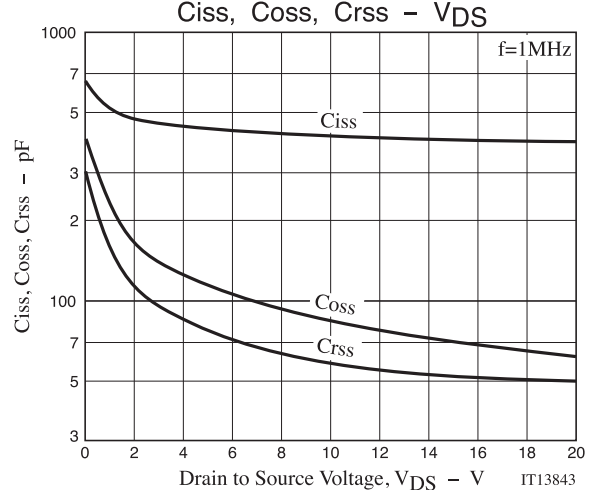
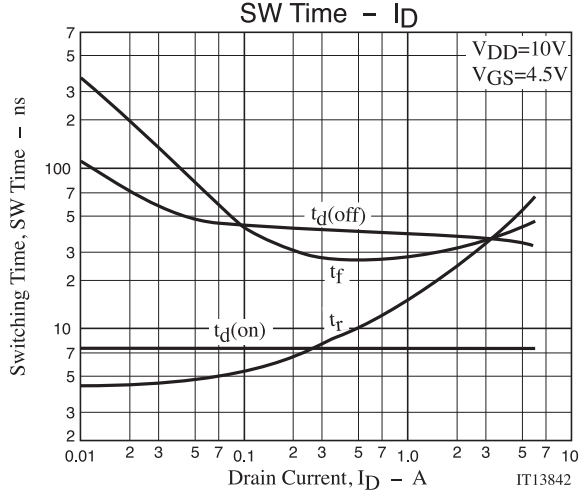
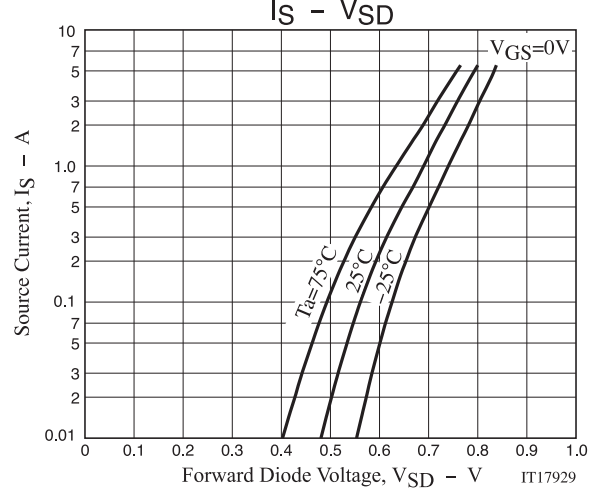
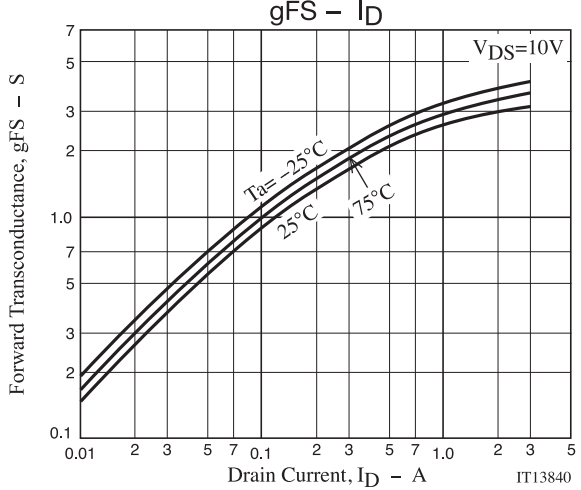
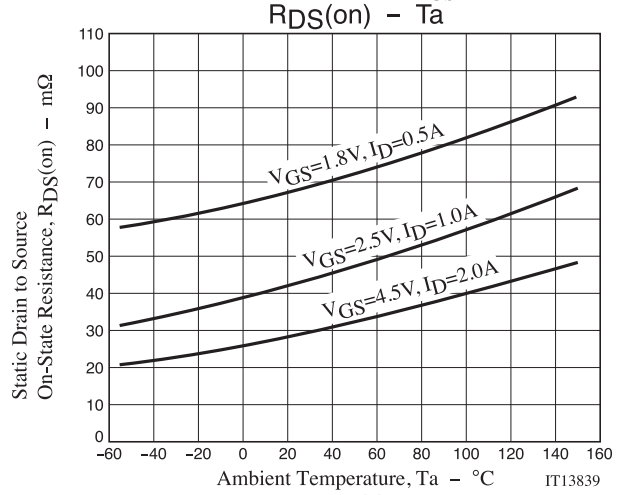
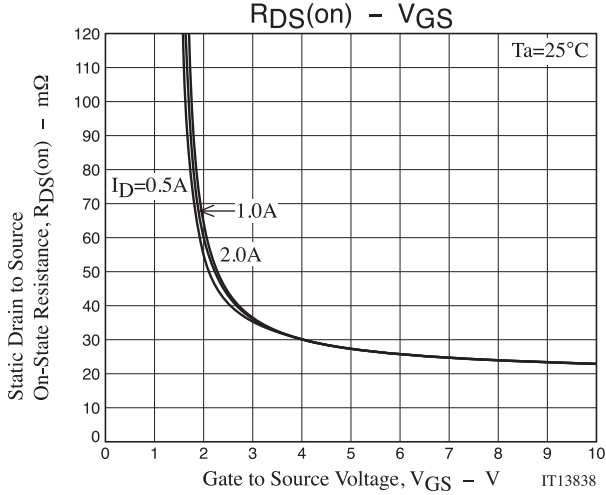
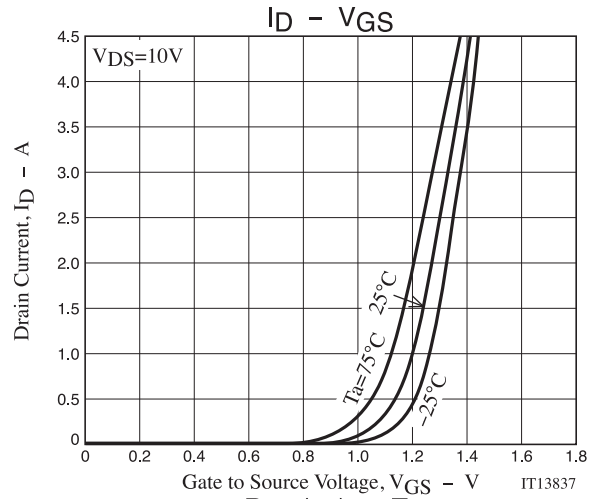
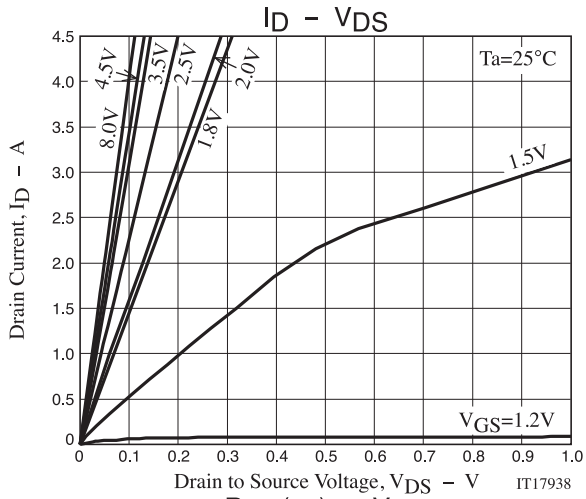

MCH6421

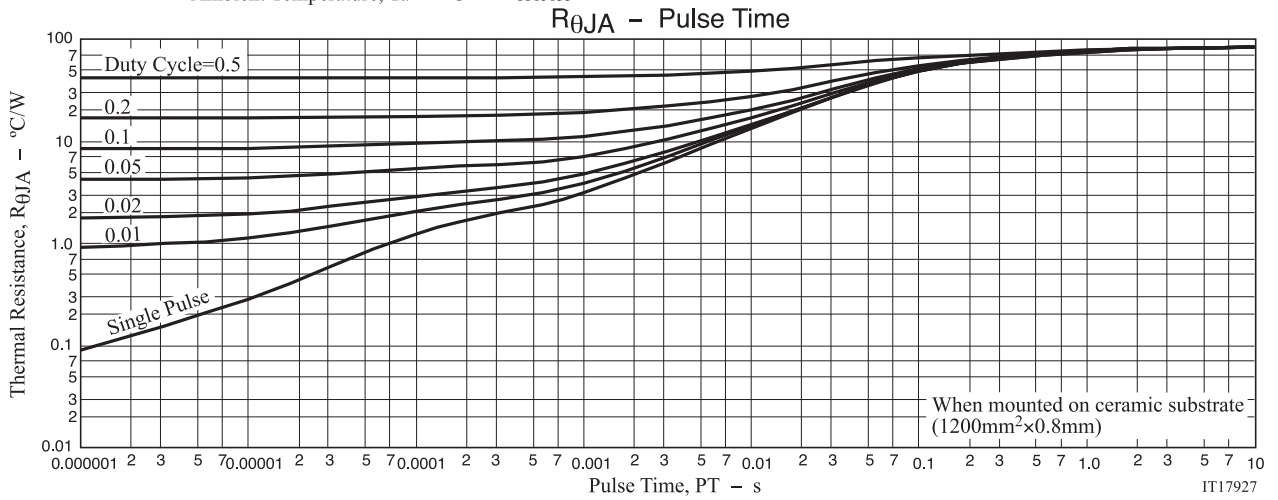
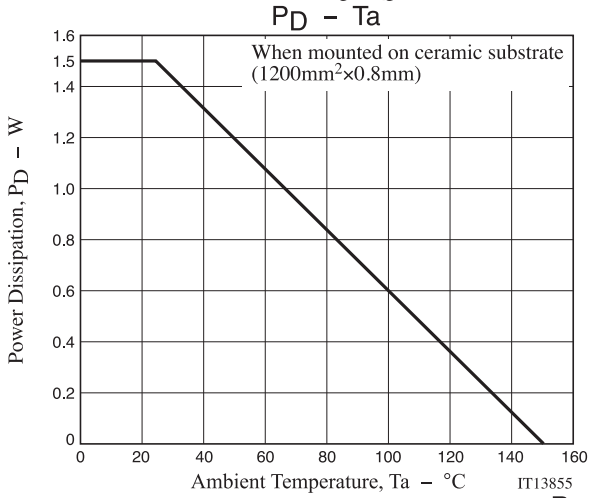
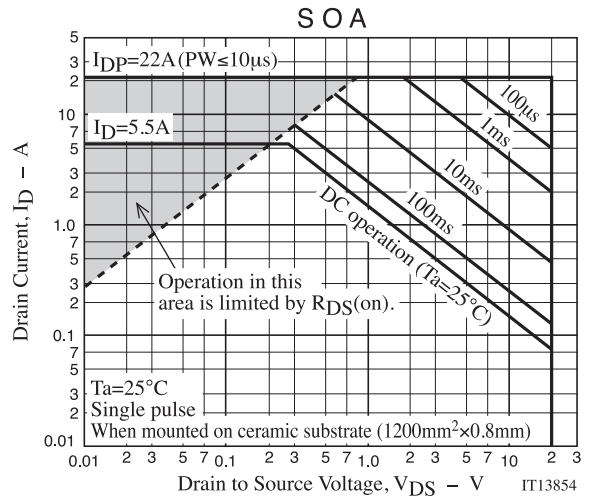
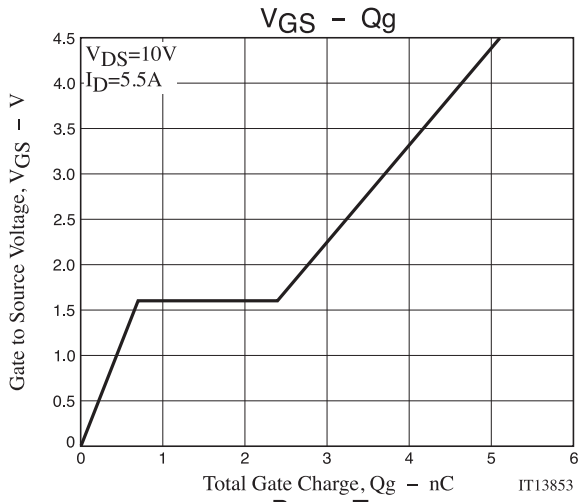

MCH6421

PACKAGE DIMENSIONS

unit : mm

SC-88FL / MCPH6
CASE 419AS
ISSUE O

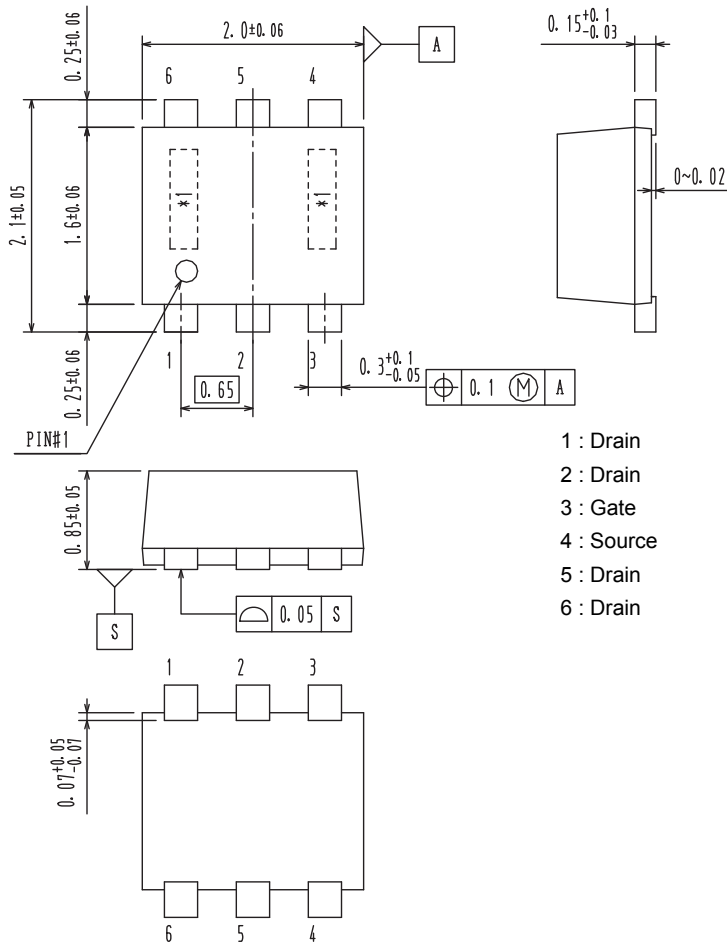

- 1 : Drain
- 2 : Drain
- 3 : Gate
- 4 : Source
- 5 : Drain
- 6 : Drain

Recommended Soldering Footprint

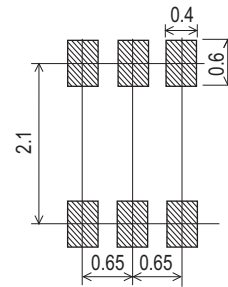

ORDERING INFORMATION

Device	Marking	Package	Shipping (Qty / Packing)
MCH6421-TL-E	KV	SC-88FL / MCPH6 (Pb-Free)	3,000 / Tape & Reel
MCH6421-TL-W		SC-88FL / MCPH6 (Pb-Free / Halogen Free)	

† For information on tape and reel specifications, including part orientation and tape sizes, please refer to our Tape and Reel Packaging Specifications Brochure, BRD8011/D. http://www.onsemi.com/pub_link/Collateral/BRD8011-D.PDF

Note on usage : Since the MCH6421 is a MOSFET product, please avoid using this device in the vicinity of highly charged objects.

ON Semiconductor and the ON logo are registered trademarks of Semiconductor Components Industries, LLC (SCILLC) or its subsidiaries in the United States and/or other countries. SCILLC owns the rights to a number of patents, trademarks, copyrights, trade secrets, and other intellectual property. A listing of SCILLC's product/patent coverage may be accessed at www.onsemi.com/site/pdf/Patent-Marking.pdf. SCILLC reserves the right to make changes without further notice to any products herein. SCILLC makes no warranty, representation or guarantee regarding the suitability of its products for any particular purpose, nor does SCILLC assume any liability arising out of the application or use of any product or circuit, and specifically disclaims any and all liability, including without limitation special, consequential or incidental damages. "Typical" parameters which may be provided in SCILLC data sheets and/or specifications can and do vary in different applications and actual performance may vary over time. All operating parameters, including "Typicals" must be validated for each customer application by customer's technical experts. SCILLC does not convey any license under its patent rights nor the rights of others. SCILLC products are not designed, intended, or authorized for use as components in systems intended for surgical implant into the body, or other applications intended to support or sustain life, or for any other application in which the failure of the SCILLC product could create a situation where personal injury or death may occur. Should Buyer purchase or use SCILLC products for any such unintended or unauthorized application, Buyer shall indemnify and hold SCILLC and its officers, employees, subsidiaries, affiliates, and distributors harmless against all claims, costs, damages, and expenses, and reasonable attorney fees arising out of, directly or indirectly, any claim of personal injury or death associated with such unintended or unauthorized use, even if such claim alleges that SCILLC was negligent regarding the design or manufacture of the part. SCILLC is an Equal Opportunity/Affirmative Action Employer. This literature is subject to all applicable copyright laws and is not for resale in any manner.