

CGHV1J006D

6 W, 18.0 GHz, GaN HEMT Die

Description

WolfSpeed's CGHV1J006D is a high voltage gallium nitride (GaN) High Electron Mobility Transistor (HEMT) on a silicon carbide substrate, using a 0.25 μm gate length fabrication process. This GaN-on-SiC product offers superior high frequency, high efficiency features. It is ideal for a variety of applications operating from 10 MHz to 18 GHz at 40 V with a high breakdown voltage.

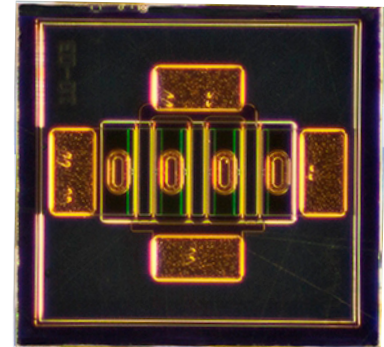

PN: CGHV1J006D

Features

- 17 dB Typ. Small Signal Gain at 10 GHz
- 60% Typ. PAE at 10 GHz
- 6 W Typical P_{SAT}
- 40 V Operation
- Up to 18 GHz Operation

Applications

- Satellite Communications
- PTP Communications Links
- Marine Radar
- Pleasure Craft Radar
- Port Vessel Traffic Services
- Broadband Amplifiers
- High Efficiency Amplifiers



Packaging Information

- Bare die are shipped in Gel-Pak® containers
- Non-adhesive tacky membrane immobilizes die during shipment



Large Signal Models Available for ADS and MWO





Absolute Maximum Ratings (not simultaneous)

Parameter	Symbol	Rating	Units	Conditions
Drain-source Voltage	V_{DS}	100	V_{DC}	25°C
Gate-source Voltage	V_{GS}	-10, +2		
Storage Temperature	T_{STG}	-65, +150	°C	
Operating Junction Temperature	T_J	225		
Maximum Forward Gate Current	I_{GMAX}	1.2	mA	25°C
Maximum Drain Current ¹	I_{DMAX}	0.8	A	
Thermal Resistance, Junction to Case (packaged) ²	$R_{\theta JC}$	17.5	°C/W	85°C
Thermal Resistance, Junction to Case (die only) ²		13.2		
Mounting Temperature	T_S	320	°C	30 seconds

Notes:

¹ Current limit for long term, reliable operation.

² Eutectic die attach using 80/20 AuSn mounted to a 40 mil thick CuMoCu carrier.

Electrical Characteristics (Frequency = 10 GHz unless otherwise stated; $T_c = 25^\circ\text{C}$)

Characteristics	Symbol	Min.	Typ.	Max.	Units	Conditions
DC Characteristics						
Gate Threshold Voltage	$V_{(GS)TH}$	-3.8	-3.0	-2.3	V	$V_{DS} = 10\text{ V}, I_D = 1.2\text{ mA}$
Gate Quiescent Voltage	$V_{(GS)Q}$	-	-2.7	-	V_{DC}	$V_{DD} = 40\text{ V}, I_{DQ} = 70\text{ mA}$
Saturated Drain Current ¹	I_{SAT}	1.0	1.1	-	A	$V_{DS} = 6.0\text{ V}, V_{GS} = 2.0\text{ V}$
Drain-Source Breakdown Voltage	V_{BD}	100	-	-	V	$V_{GS} = -8\text{ V}, I_D = 1.2\text{ mA}$
On Resistance	R_{ON}	-	2.3	-	Ω	$V_{DS} = 0.1\text{ V}, V_{GS} = 0\text{ V}$
Gate Forward Voltage	V_{G-ON}	-	1.85	-	V	$I_{GS} = 1.2\text{ mA}$
RF Characteristics						
Small Signal Gain	G_{SS}	-	17	-	dB	$V_{DD} = 40\text{ V}, I_{DQ} = 70\text{ mA}$
Saturated Power Output ¹	P_{SAT}	-	6	-	W	
Drain Efficiency ²	η	-	60	-	%	
Intermodulation Distortion	IM3	-	-30	-	dBc	$V_{DD} = 40\text{ V}, I_{DQ} = 70\text{ mA}, P_{OUT} = 6\text{ W PEP}$
Output Mismatch Stress	VSWR	-	-	10 : 1	Ψ	No damage at all phase angles, $V_{DD} = 40\text{ V}, I_{DQ} = 70\text{ mA},$ $P_{OUT} = 6\text{ W CW}$
Dynamic Characteristics						
Input Capacitance	C_{GS}	-	2.0	-	pF	$V_{DS} = 40\text{ V}, V_{GS} = -8\text{ V}, f = 1\text{ MHz}$
Output Capacitance	C_{DS}	-	0.35	-		
Feedback Capacitance	C_{GD}	-	0.5	-		

Notes:

¹ Scaled from PCM unit cell

³ Drain Efficiency = P_{OUT} / P_{DC}

² P_{SAT} is defined as $I_G = 0.12\text{ mA}$

Die Dimensions (units in microns)

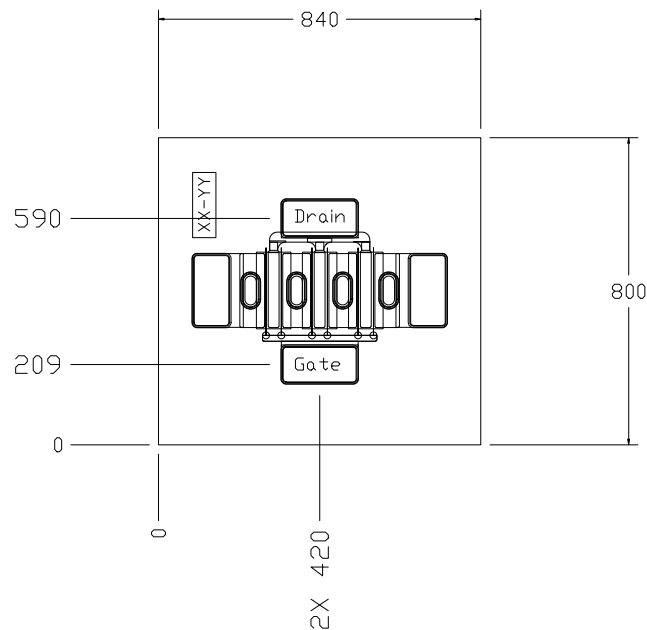

Overall die size 800 x 840 (+0/-50) microns, die thickness 100 (+/-10) microns.
All Gate and Drain pads must be wire bonded for electrical connection.

Pad	Size (microns)
Drain	202 x 102
Gate	202 x 102

Assembly Notes

- Recommended solder is AuSn (80/20) solder. Refer to Wolfspeed's website for the Eutectic Die Attach Procedure application note at www.wolfspeed.com/document-library/?documentType=application-notes&productLine=rf
- Vacuum collet is the preferred method of pick-up
- The backside of the die is the Source (ground) contact
- Die back side gold plating is 5 microns thick minimum
- Thermosonic ball or wedge bonding are the preferred connection methods
- Gold wire must be used for connections
- Use the die label (XX-YY) for correct orientation

Electrostatic Discharge (ESD) Classifications

Parameter	Symbol	Class	Classification Level	Test Methodology
Human Body Model	HBM	1A	ANSI/ESDA/JEDEC JS-001 Table 3	JEDEC JESD22 A114-D



G_{MAX} and K Factor

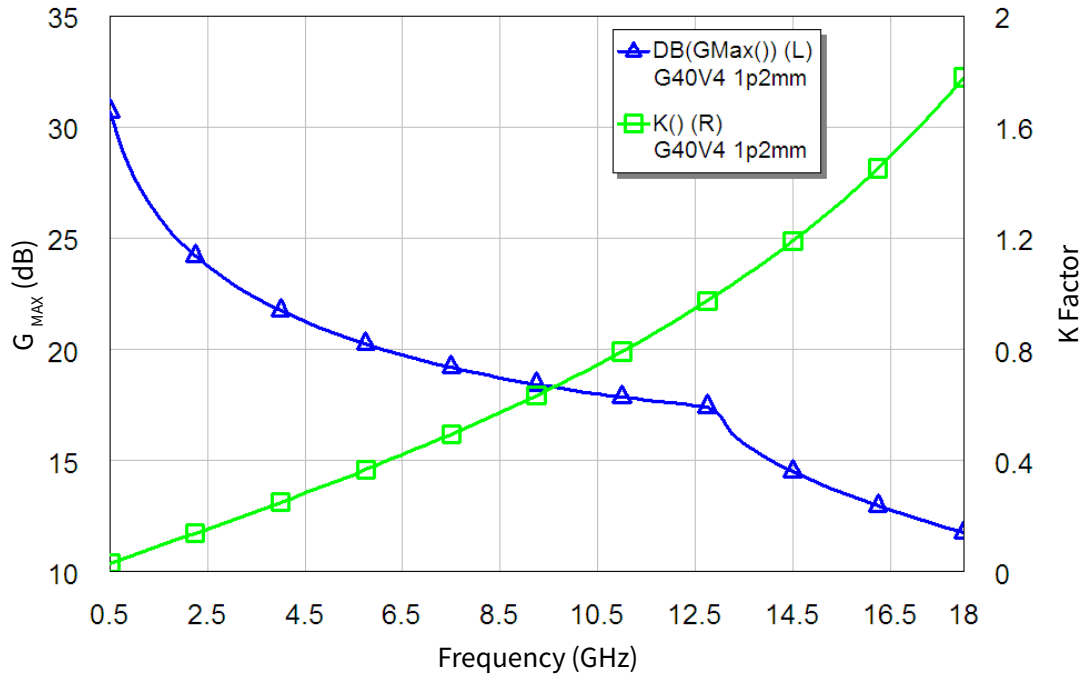

Figure 1. CGHV1J006D - Stability with G_{MAX} and K Factor
V_{DD} = 40 V, I_{DS} = 30 mA

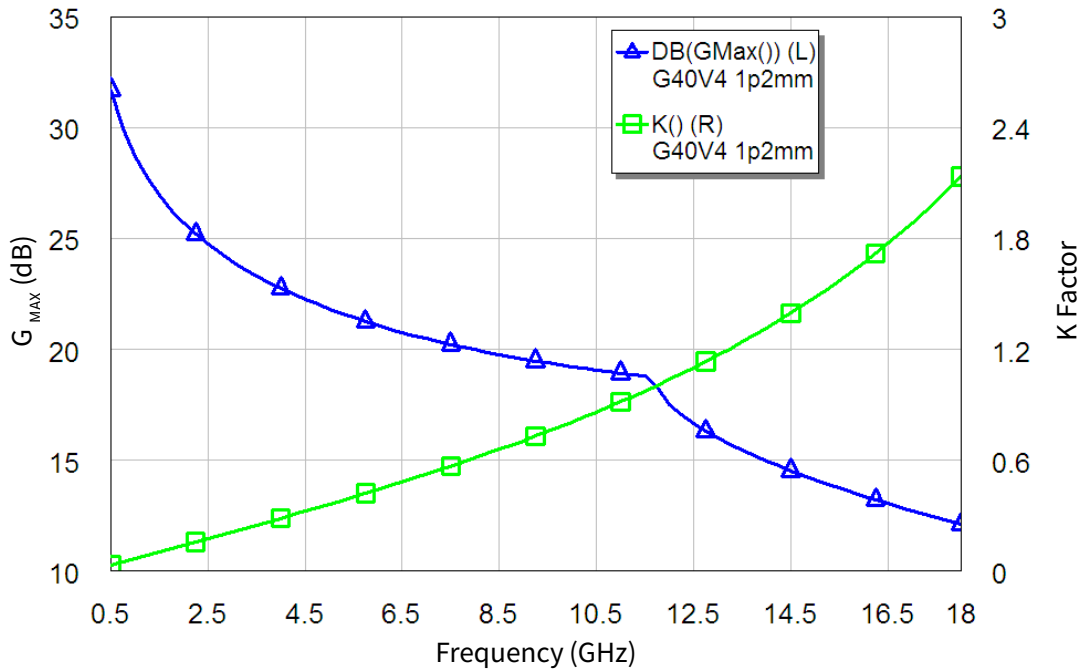
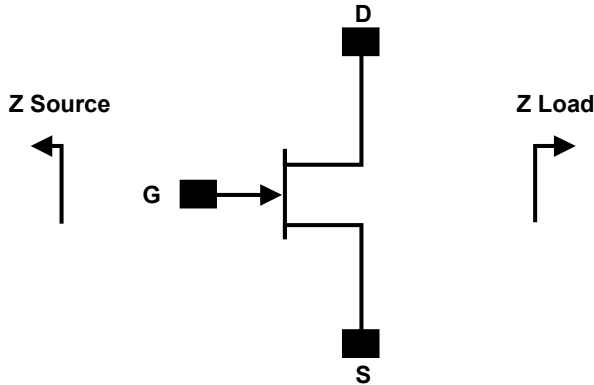

Figure 2. CGHV1J006D - Stability with G_{MAX} and K Factor
V_{DD} = 40 V, I_{DS} = 60 mA



Source and Load Impedances



Frequency (GHz)	Z Source	Z Load
1.0	33.5 + j43.4	136.8 + j99
2.0	14.8 + j19.9	66.1 + j103.5
3.0	8.92 + j13.2	36.3 + j81.3
4.0	7.28 + j9.64	25 + j69.1
5.0	6.25 + j7.2	19.1 + j58
6.0	5.4 + j5.2	13.47 + j49.5
7.0	4.9 + j3.54	11 + j43.4
8.0	4.67 + j2.39	9.84 + j38.5
9.0	4 + j1.21	8.76 + j34.2
10.0	3.56 + j0.155	7.93 + j30.75
11.0	3.2 - j0.226	7.68 + j27.87
12.0	1.7 - j0.35	7.36 + j24.8
13.0	1.68 - j1.27	6.76 + j23
14.0	1.73 - j2.18	5.59 + j20.5
15.0	1.99 - j3.04	4.88 + j18.76
16.0	2.41 - j3.89	4.27 + j17.11
17.0	1.72 - j4.84	3.9 + j15.26
18.0	2.1 - j5.71	3.4 + j14

Note: $V_{DD} = 40\text{ V}$, $I_{DQ} = 45\text{ mA}$

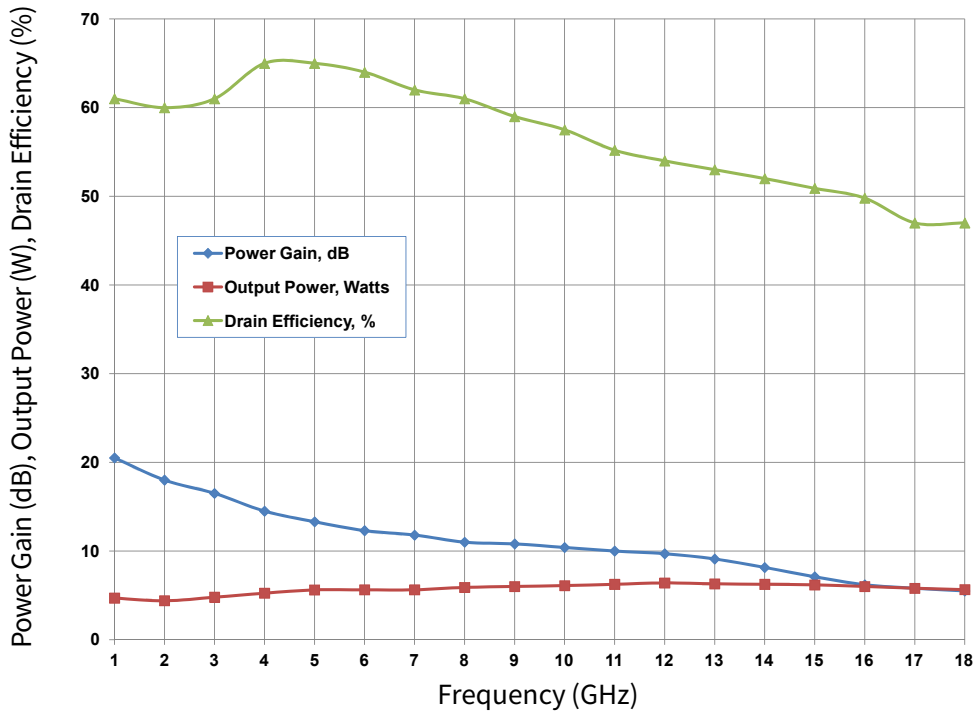

Figure 3. CGHV1J006D - Power Gain, Output Power and Drain Efficiency using Source and Load Pull Impedances (Series gate stability resistor values chosen to make $K > 1$)



Typical S-Parameters for CGHV1J006D
 (Small Signal, $V_{DS} = 40\text{ V}$, $I_{DQ} = 30\text{ mA}$, angle in degrees)

Frequency	Mag S11	Ang S11	Mag S21	Ang S21	Mag S12	Ang S12	Mag S22	Ang S22
500 MHz	0.987	-38.19	15.03	156.70	0.013	67.25	0.827	-13.92
1.00 GHz	0.962	-69.56	12.91	137.32	0.022	48.44	0.769	-25.11
1.50 GHz	0.940	-92.69	10.74	122.53	0.027	34.21	0.717	-33.51
2.00 GHz	0.925	-109.31	8.96	111.22	0.030	23.46	0.681	-40.24
2.50 GHz	0.915	-121.46	7.56	102.25	0.032	15.04	0.660	-46.13
3.00 GHz	0.910	-130.61	6.48	94.83	0.033	8.18	0.649	-51.59
3.50 GHz	0.906	-137.71	5.63	88.46	0.033	2.38	0.646	-56.81
4.00 GHz	0.904	-143.40	4.95	82.85	0.033	-2.67	0.647	-61.83
4.50 GHz	0.903	-148.06	4.39	77.79	0.033	-7.17	0.651	-66.69
5.00 GHz	0.903	-151.98	3.93	73.16	0.033	-11.24	0.658	-71.37
5.50 GHz	0.903	-155.34	3.54	68.86	0.032	-14.97	0.666	-75.87
6.00 GHz	0.904	-158.26	3.21	64.84	0.032	-18.42	0.675	-80.19
6.50 GHz	0.904	-160.85	2.93	61.05	0.031	-21.64	0.685	-84.33
7.00 GHz	0.905	-163.18	2.68	57.46	0.030	-24.66	0.695	-88.30
7.50 GHz	0.906	-165.28	2.47	54.05	0.030	-27.50	0.706	-92.09
8.00 GHz	0.908	-167.22	2.27	50.79	0.029	-30.19	0.716	-95.71
8.50 GHz	0.909	-169.00	2.11	47.66	0.028	-32.73	0.726	-99.18
9.00 GHz	0.910	-170.67	1.95	44.67	0.027	-35.14	0.736	-102.49
9.50 GHz	0.911	-172.24	1.82	41.78	0.027	-37.44	0.746	-105.65
10.00 GHz	0.912	-173.72	1.70	39.01	0.026	-39.63	0.755	-108.67
10.50 GHz	0.914	-175.12	1.59	36.33	0.025	-41.71	0.764	-111.56
11.00 GHz	0.915	-176.47	1.49	33.74	0.024	-43.70	0.773	-114.33
11.50 GHz	0.916	-177.75	1.40	31.23	0.024	-45.60	0.781	-116.99
12.00 GHz	0.917	-179.00	1.31	28.80	0.023	-47.41	0.788	-119.53
12.50 GHz	0.918	-179.80	1.24	26.45	0.022	-49.15	0.796	-121.97
13.00 GHz	0.919	-178.64	1.17	24.16	0.021	-50.81	0.803	-124.31
13.50 GHz	0.920	-177.51	1.10	21.94	0.021	-52.40	0.809	-126.57
14.00 GHz	0.921	-176.41	1.05	19.78	0.020	-53.91	0.816	-128.74
14.50 GHz	0.922	-175.33	0.99	17.67	0.019	-55.37	0.822	-130.82
15.00 GHz	0.922	-174.27	0.94	15.62	0.019	-56.75	0.827	-132.84
15.25 GHz	0.923	-173.75	0.92	14.61	0.018	-57.42	0.830	-133.82
15.50 GHz	0.923	-173.24	0.90	13.62	0.018	-58.08	0.833	-134.78
15.75 GHz	0.923	-172.73	0.87	12.64	0.017	-58.71	0.835	-135.73
16.00 GHz	0.924	-172.22	0.85	11.66	0.017	-59.34	0.838	-136.66
16.25 GHz	0.924	-171.72	0.83	10.70	0.017	-59.95	0.840	-137.57
16.50 GHz	0.924	-171.22	0.81	9.75	0.016	-60.54	0.843	-138.47
16.75 GHz	0.925	-170.72	0.79	8.81	0.016	-61.12	0.845	-139.36
17.00 GHz	0.925	-170.23	0.78	7.88	0.016	-61.68	0.847	-140.23
17.25 GHz	0.925	-169.74	0.76	6.96	0.015	-62.23	0.849	-141.09
17.50 GHz	0.926	-169.26	0.74	6.05	0.015	-62.77	0.851	-141.93
17.75 GHz	0.926	-168.77	0.72	5.15	0.015	-63.29	0.853	-142.76
18.00 GHz	0.926	-168.29	0.71	4.26	0.015	-63.79	0.855	-143.58

To download the s-parameters in s2p format, go to the [CGHV1J006D](#) Product page and click on the documentation tab.



Typical S-Parameters for CGHV1J006D
 (Small Signal, $V_{DS} = 40\text{ V}$, $I_{DQ} = 60\text{ mA}$, angle in degrees)

Frequency	Mag S11	Ang S11	Mag S21	Ang S21	Mag S12	Ang S12	Mag S22	Ang S22
500 MHz	0.984	-43.78	18.23	153.94	0.012	64.52	0.776	-15.67
1.00 GHz	0.956	-77.79	15.10	133.43	0.020	44.60	0.706	-27.34
1.50 GHz	0.935	-101.29	12.21	118.66	0.025	30.42	0.650	-35.52
2.00 GHz	0.922	-117.38	9.99	107.78	0.027	20.12	0.616	-41.92
2.50 GHz	0.914	-128.78	8.34	99.30	0.028	12.23	0.598	-47.57
3.00 GHz	0.909	-137.20	7.10	92.33	0.029	5.85	0.590	-52.89
3.50 GHz	0.906	-143.67	6.14	86.37	0.029	0.48	0.590	-58.01
4.00 GHz	0.905	-148.80	5.38	81.10	0.029	-4.20	0.594	-62.98
4.50 GHz	0.904	-153.01	4.76	76.33	0.028	-8.37	0.601	-67.78
5.00 GHz	0.904	-156.53	4.26	71.95	0.028	-12.16	0.610	-72.42
5.50 GHz	0.905	-159.55	3.84	67.88	0.028	-15.63	0.620	-76.88
6.00 GHz	0.905	-162.19	3.48	64.05	0.027	-18.86	0.631	-81.15
6.50 GHz	0.906	-164.52	3.17	60.43	0.027	-21.87	0.643	-85.25
7.00 GHz	0.907	-166.62	2.90	56.99	0.026	-24.70	0.655	-89.17
7.50 GHz	0.908	-168.54	2.67	53.70	0.025	-27.38	0.667	-92.91
8.00 GHz	0.909	-170.29	2.46	50.56	0.025	-29.90	0.679	-96.48
8.50 GHz	0.910	-171.92	2.28	47.54	0.024	-32.30	0.691	-99.90
9.00 GHz	0.912	-173.45	2.12	44.63	0.023	-34.58	0.702	-103.16
9.50 GHz	0.913	-174.89	1.97	41.83	0.023	-36.75	0.713	-106.27
10.00 GHz	0.914	-176.25	1.84	39.12	0.022	-38.81	0.724	-109.25
10.50 GHz	0.915	-177.55	1.72	36.51	0.021	-40.78	0.734	-112.10
11.00 GHz	0.916	-178.80	1.62	33.97	0.021	-42.65	0.744	-114.83
11.50 GHz	0.917	-180.00	1.52	31.52	0.020	-44.44	0.753	-117.45
12.00 GHz	0.918	-178.84	1.43	29.14	0.019	-46.14	0.762	-119.96
12.50 GHz	0.919	-177.72	1.35	26.82	0.019	-47.77	0.770	-122.37
13.00 GHz	0.920	-176.62	1.27	24.57	0.018	-49.31	0.778	-124.68
13.50 GHz	0.921	-175.56	1.20	22.38	0.017	-50.79	0.786	-126.90
14.00 GHz	0.922	-174.52	1.14	20.25	0.017	-52.19	0.793	-129.05
14.50 GHz	0.922	-173.49	1.08	18.16	0.016	-53.52	0.800	-131.11
15.00 GHz	0.923	-172.49	1.03	16.13	0.015	-54.78	0.806	-133.10
15.25 GHz	0.923	-172.00	1.00	15.14	0.015	-55.38	0.810	-134.07
15.50 GHz	0.924	-171.51	0.98	14.15	0.015	-55.97	0.813	-135.02
15.75 GHz	0.924	-171.02	0.95	13.18	0.015	-56.53	0.816	-135.96
16.00 GHz	0.924	-170.54	0.93	12.21	0.014	-57.09	0.818	-136.88
16.25 GHz	0.925	-170.06	0.91	11.26	0.014	-57.62	0.821	-137.79
16.50 GHz	0.925	-169.58	0.89	10.32	0.014	-58.13	0.824	-138.68
16.75 GHz	0.925	-169.11	0.87	9.38	0.013	-58.63	0.827	-139.55
17.00 GHz	0.926	-168.63	0.85	8.46	0.013	-59.11	0.829	-140.42
17.25 GHz	0.926	-168.16	0.83	7.54	0.013	-59.57	0.832	-141.27
17.50 GHz	0.926	-167.70	0.81	6.64	0.012	-60.02	0.834	-142.10
17.75 GHz	0.926	-167.23	0.79	5.74	0.012	-60.44	0.836	-142.93
18.00 GHz	0.927	-166.77	0.78	4.86	0.012	-60.84	0.839	-143.74

To download the s-parameters in s2p format, go to the [CGHV1J006D](#) Product page and click on the documentation tab.



Part Number System

CGHV1J006D

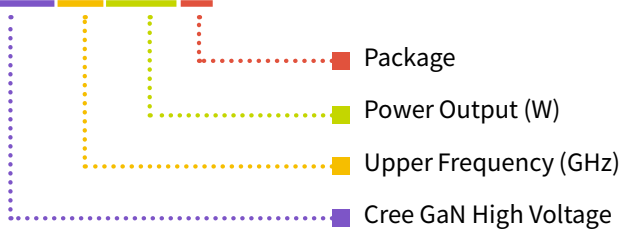

Table 1.

Parameter	Value	Units
Lower Frequency	DC	GHz
Upper Frequency ¹	18.0	GHz
Power Output	6	W
Package	Bare Die	-

Notes:

¹ Alpha characters used in frequency code indicate a value greater than 9.9 GHz. See Table 2 for value

Table 2.

Parameter	Value
A	0
B	1
C	2
D	3
E	4
F	5
G	6
H	7
J	8
K	9
Examples:	1A = 10.0 GHz 2H = 27.0 GHz

Product Ordering Information

Order Number	Description	Unit of Measure
CGHV1J006D	GaN HEMT Bare Die	Each

**For more information, please contact:**

4600 Silicon Drive
Durham, NC 27703 USA
Tel: +1.919.313.5300
www.wolfspeed.com/RF

Sales Contact
RFSales@wolfspeed.com

RF Product Marketing Contact
RFMarketing@wolfspeed.com

Notes & Disclaimer

Specifications are subject to change without notice. “Typical” parameters are the average values expected by Wolfspeed in large quantities and are provided for information purposes only. Wolfspeed products are not warranted or authorized for use as critical components in medical, life-saving, or life-sustaining applications, or other applications where a failure would reasonably be expected to cause severe personal injury or death. No responsibility is assumed by Wolfspeed for any infringement of patents or other rights of third parties which may result from use of the information contained herein. No license is granted by implication or otherwise under any patent or patent rights of Wolfspeed.

© 2011-2022 Wolfspeed, Inc. All rights reserved. Wolfspeed® and the Wolfstreak logo are registered trademarks and the Wolfspeed logo is a trademark of Wolfspeed, Inc.
PATENT: <https://www.wolfspeed.com/legal/patents>

The information in this document is subject to change without notice.