

order number	lens name	Azimuth
0701-391-000-40	Rodagon 4/80	-
0701-391-000-42	Rodagon 4/80	marked

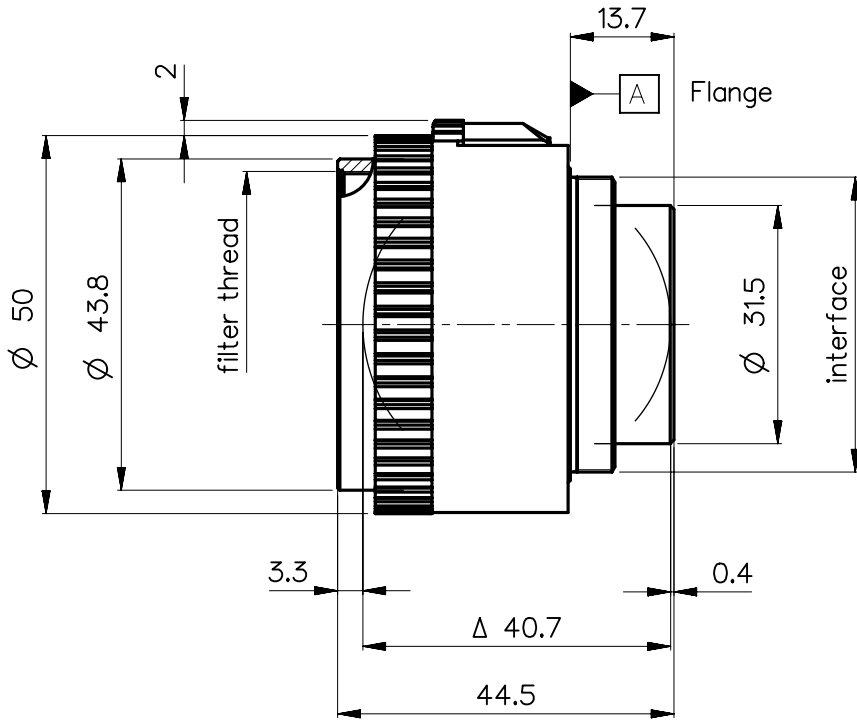

Specification		ON	7431-9001
image circle max. (mm)	62	working distance (mm)	216 - 1406
focal length f' (mm)	81.1	interface	M39 x1/26" (Leica)
magnification β' [range]	-0.25 [-0.5 ... -0.06]	filter thread	M40.5 x0.5
spectral range λ (nm)	400 - 750	weight (g)	115

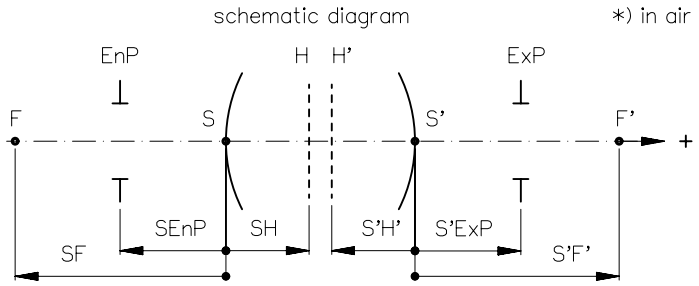

design includes CCD cover glass:		no		
SF (mm)	-57.7	f-stop	Ø EnP	Ø ExP
S'F' (mm) *	61.3	4	20.3	20.3
HH' (mm) *	-2.6	5.6	14.5	14.5
SH (mm)	23.4	8	10.1	10.1
S'H' (mm) *	-19.9	11	7.4	7.4
SEnP (mm)	23.5	16	5.1	5.1
S'ExP (mm) *	-19.8	22	3.7	3.7

Schutzvermerk "DIN ISO 16016" beachten	EU-D		AL-T1A		US-D		US-ML		not export controlled		
	Rev.		Datum		Freigabe		PDM-Status		-		
	a Neuausg						Freigabe				
	b 11-027		22.09.11		Schiffe		Maßstab		1:1		
	c 12-0185		27.03.12		Schuber		Werkstoff				
	d 14-0184		17.04.14		Schiffe		Tolerierung		Benennung		
e 14-0184		12.08.14		Schiffe		Erster- stellung		Rodagon 4/80			
f 16-0384		16.06.16		Bo II							
										Datum	
						22.07.11		Kuehne			
						Prüfung		22.07.11		Stauder	
								Zeichnungsnummer		Blatt 1	
								0701-391-100-00-0001f		von 1	
								Ersatz für			

DIN A 4

Alle Maße in mm, inklusive Oberflächenbehandlung



Rodagon_80

MTF at ratio 0.25x f/ 4

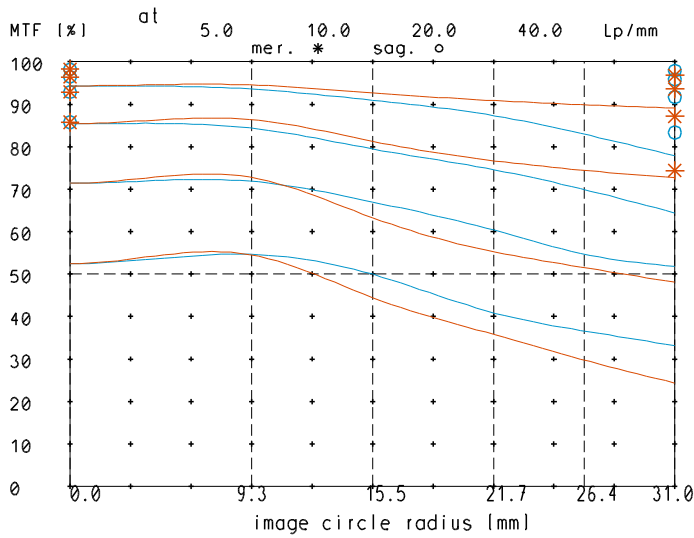

relative light fall-off at ratio 0.25x

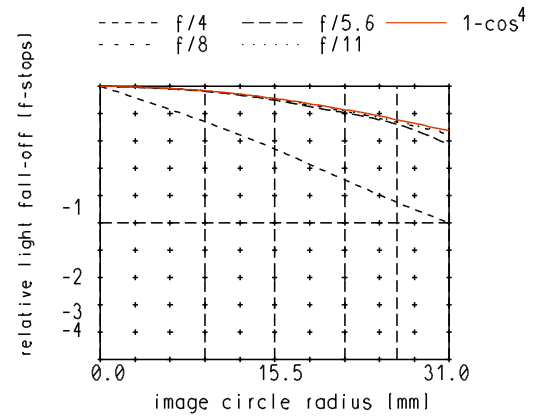

MTF at ratio 0.25x f/ 8

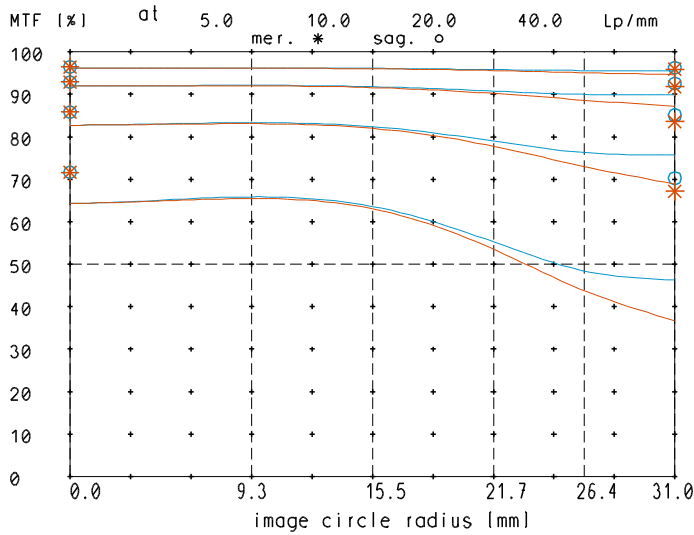

Distortion at ratio 0.1x to 0.5x

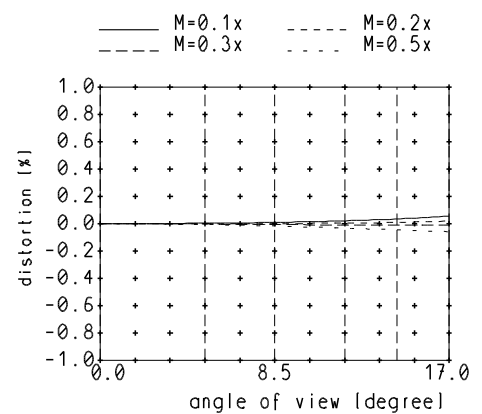

— sagittal. o Diffraction limited value
— meridional * Diffraction limited value

Longitudinal color aberration at ratio 0.25x

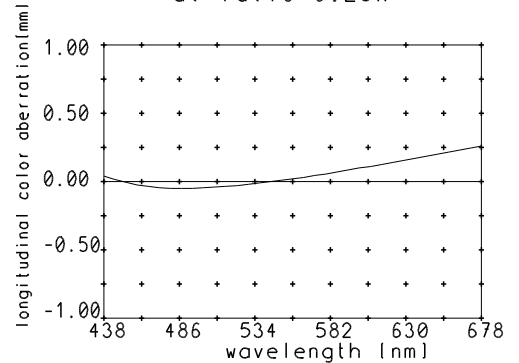

Named frequencies (line pairs/mm) in modular transfer function (MTF) as well as diagrams of relative light fall-off, distortion and longitudinal color aberration refer to film plane.