

CLC501

High Speed, Output Clamping Op Amp

General Description

The CLC501 is a high speed current-feedback op amp with the unique feature of output voltage clamping. This feature allows both the maximum positive (V_{HIGH}) and negative (V_{LOW}) output voltage levels to be established. This is useful in a number of applications in which "downstream" circuitry must be protected from over driving input signals. Not only can this prevent damage to downstream circuitry, but can also reduce time delays since saturation is avoided. The CLC501's very fast 1ns overload/clamping recovery time is useful in applications in which information containing signals follow overdriving signals.

Engineers designing high resolution, subranging A/D systems have long sought an amplifier capable of meeting the demanding requirements of the residue amplifier function. Amplifiers providing the residue function must not only settle quickly, but recover from overdrive quickly, protect the second stage A/D, and provide high fidelity at relatively high gain settings. The CLC501, which excels in these areas, is the ideal design solution in this onerous application. To further support this application, the CLC501 is both characterized and tested at a gain setting of +32—the most common gain setting for residue amplifier applications.

The CLC501's other features provide a quick, high performance design solution. Since the CLC501's current feedback design requires no external compensation, designers need not spend their time designing compensation networks. The small 8-pin package and low, 180mW power consumption make the CLC501 ideal in numerous applications having small power and size budgets.

The CLC501 is available in several versions to meet a variety of requirements. A three letter suffix determines the version:

- Enhanced Solutions (Military/Aerospace)
- SMD Number: 5962-94597

*Space level version also available.

*For more information, visit <http://www.national.com/mil>

Features

- Output clamping (V_{HIGH} and V_{LOW})
- 1ns recovery from clamping/overdrive
- 0.05% settling in 12ns
- Characterized and guaranteed at $A_V = +32$
- Low power: 180mW

Applications

- Residue amplifier in high accuracy, subranging A/D systems
- High speed communications
- Output clamping applications
- Pulse amplitude modulation systems

Clamped Pulse Response

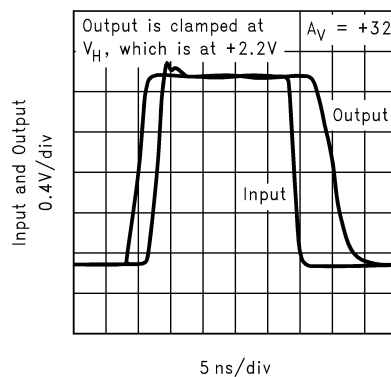

Connection Diagram

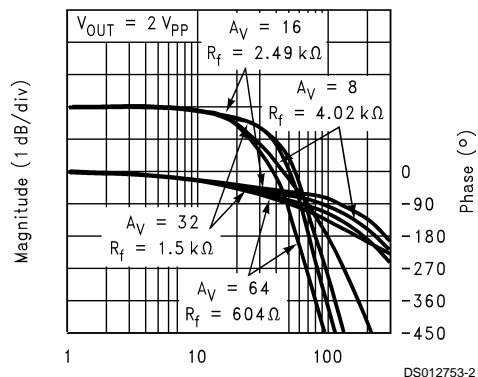
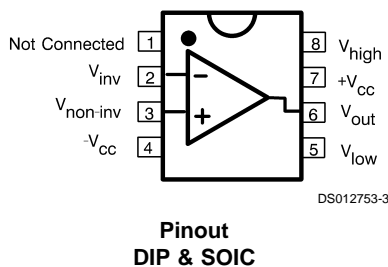

Ordering Information

Package	Temperature Range Industrial	Part Number	Package Marking	NSC Drawing
8-Pin Plastic DIP	-40°C to +85°C	CLC501AJP	CLC501AJP	N08E
8-Pin Plastic SOIC	-40°C to +85°C	CLC501AJE	CLC501AJE	M08A

Absolute Maximum Ratings (Note 1)

If Military/Aerospace specified devices are required, please contact the National Semiconductor Sales Office/Distributors for availability and specifications.

Supply Voltage (V_{CC}) $\pm 7V$

I_{OUT}

Output is short circuit protected to ground, but maximum reliability will be maintained if I_{OUT} does not exceed...

60mA

Common Mode Input Voltage $\pm V_{CC}$

Junction Temperature $+150^{\circ}C$

Operating Temperature Range $-40^{\circ}C$ to $+85^{\circ}C$

Storage Temperature Range $-65^{\circ}C$ to $+150^{\circ}C$

Lead Solder Duration ($+300^{\circ}C$) 10 sec

ESD Rating (Human Body Model) $<1000V$

Recommended Gain Range $+7$ to $+50$
 -1 to -50

Operating Ratings

Thermal Resistance

Package (θ_{JC}) (θ_{JA})

MDIP $70^{\circ}C/W$ $125^{\circ}C/W$

SOIC $65^{\circ}C/W$ $145^{\circ}C/W$

Electrical Characteristics

($A_V = +32$, $V_{CC} = \pm 5V$, $R_L = 100\Omega$, $R_f = 1.5\Omega$, $V_H = +3V$; unless specified)

Symbol	Parameters	Condition	Typ	Max & Min Ratings(Notes 2)			Units
Ambient Temperature		CLC501AJ	$+25^{\circ}C$	$-40^{\circ}C$	$+25^{\circ}C$	$+85^{\circ}C$	
Frequency Domain Response							
SSBW	-3dB Bandwidth	$V_{OUT} < 5V_{PP}$	75	>60	>60	>45	MHz
SS20	-3dB Bandwidth	@ $A_V = +20$, $V_{OUT} < 2V_{PP}$	110	>85	>85	>55	MHz
	Gain Flatness	$V_{OUT} < 5V_{PP}$					
GFPL	Peaking	$<15MHz$	0	<0.1	<0.1	<0.1	dB
GFPH	Peaking	$>15MHz$	0	<0.2	<0.2	<0.2	dB
GFR	Rolloff	$<30MHz$	0.2	<1.0	<1.0	<1.3	dB
LPD	Linear Phase Deviation	DC to 30MHz	0.2	<1.0	<1.0	<1.0	deg
Time Domain Response							
TRS	Rise and Fall Time	2V Step	4.7	<5.8	<5.8	<7.8	ns
TRL		5V Step	5.5	<6.5	<6.5	<8.0	ns
TSP	Settling Time to $\pm 0.05\%$	2V Step	12	<18	<18	<24	ns
OS	Overshoot	2V Step	0	<5	<5	<5	%
SR	Slew Rate		1200	>800	>800	>700	V/ μs
Distortion And Noise Response							
HD2	2nd Harmonic Distortion	$2V_{PP}$, 20MHz	-45	<-30	<-33	<-30	dBc
HD3	3rd Harmonic Distortion	$2V_{PP}$, 20MHz	-60	<-45	<-50	<-50	dBc
	Equivalent Input Noise						
SNF	Noise Floor	$>1MHz$	-158	<-156	<-156	<-155	dBm (1Hz)
INV	Integrated Noise	1MHz to 100MHz	28	<35	<35	<40	μV
Clamp Performance							
OVC	Overshoot in Clamp	32x Overdrive	5	-	<15	-	%
TSO	Overload Recovery from Clamp	32x Overdrive	1	<3	<3	<3	ns
CDR	V_{io} Drift after Recovery		150	<200	<200	<200	μV
VOC	Clamp Accuracy(Notes 3)	$>2x$ Overdrive	0.1	<0.2	<0.2	<0.2	V
ICL	Input Bias Current on V_H , V_L		20	<100	<50	<50	μA
CBW	-3dB Bandwidth	$V_L, V_H = 2V_{PP}$	50	-	-	-	MHz
CMC	Useful Clamping Range	V_H or V_L		$<\pm 3.0$	$<\pm 3.3$	$<\pm 3.3$	V
Static, DC Performance							
VIO	Input Offset Voltage(Notes 3)		1.5	<4.6	<3.0	<5.0	mV
DVIO	Average Temperature Coefficient		10	<20	-	<20	$\mu V/^{\circ}C$
IBN	Input Bias Current(Notes 3)	Non-Inverting	10	<37	<25	<35	μA

Electrical Characteristics (Continued)

($A_V = +32$, $V_{CC} = \pm 5\text{ V}$, $R_L = 100\Omega$, $R_f = 1.5\Omega$, $V_H = +3\text{V}$; unless specified)

Symbol	Parameters	Condition	Typ	Max & Min Ratings(Note 2)			Units
Static, DC Performance							
DIBN	Average Temperature Coefficient		100	<150	–	<100	nA/°C
IBI	Input Bias Current(Note 3)	Inverting	10	<46	<30	<40	μA
DIBI	Average Temperature Coefficient		100	<200	–	<100	nA/°C
PSRR	Power Supply Rejection Ratio		70	>55	>60	>60	dB
CMRR	Common Mode Rejection Ratio		70	>55	>60	>60	dB
ICC	Supply Current(Note 3)	No Load	18	<25	<24	<24	mA
Miscellaneous Performance							
RIN	Non-Inverting Input	Resistance	150	>50	>100	>100	k Ω
CIN		Capacitance	4	<7	<7	<7	pF
RO	Output Impedance	at DC	0.2	<0.3	<0.3	<0.3	Ω
CMIR	Common Mode Input Range		3.0	>2.0	>2.5	>2.5	V
VO	Output Voltage Range	No Load	$\pm 3.5\text{V}$	$>\pm 3.0$	$>\pm 3.2$	$>\pm 3.2$	V
IO	Output Current	-40°C to $+85^\circ\text{C}$	± 60	$>\pm 35$	$>\pm 50$	$>\pm 50$	mA
IO		-55°C to $+125^\circ\text{C}$	± 60	$>\pm 30$	$>\pm 50$	$>\pm 50$	mA

Note 1: "Absolute Maximum Ratings" are those values beyond which the safety of the device cannot be guaranteed. They are not meant to imply that the devices should be operated at these limits. The table of "Electrical Characteristics" specifies conditions of device operation.

Note 2: Min/max ratings are based on product characterization and simulation. Individual parameters are tested as noted. Individual parameters are tested as noted. Outgoing quality levels are determined from tested parameters.

Note 3: AJ 100% tested at $+25^\circ\text{C}$, sample at $+85^\circ\text{C}$

Typical Performance Characteristics ($T_A = 25^\circ$, $A_V = +32$, $V_{CC} = \pm 5\text{V}$, $R_L = 100\Omega$, $R_f = 1.5\Omega$, $V_H = +3\text{V}$, $V_L = -3\text{V}$)

Non-Inverting Frequency Response

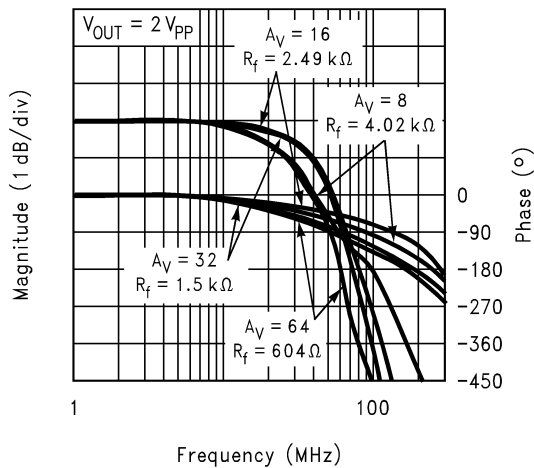

Inverting Frequency Response

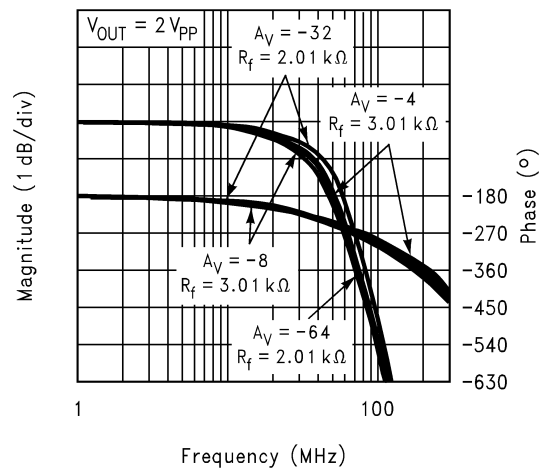

Typical Performance Characteristics ($T_A = 25^\circ$, $A_V = +32$, $V_{CC} = \pm 5V$, $R_L = 100\Omega$, $R_f = 1.5\Omega$, $V_H = +3V$, $V_L = -3V$) (Continued)

Frequency Response for R_L S

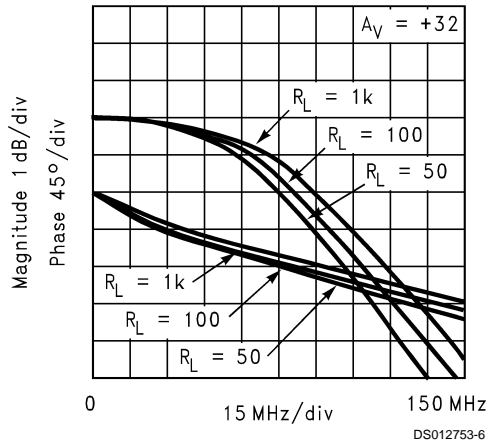

Open-Loop Transimpedance Gain, $Z(s)$

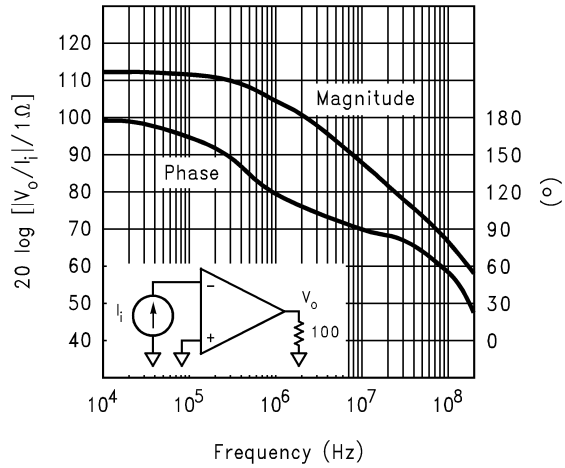

2nd and 3rd Harmonic Distortion

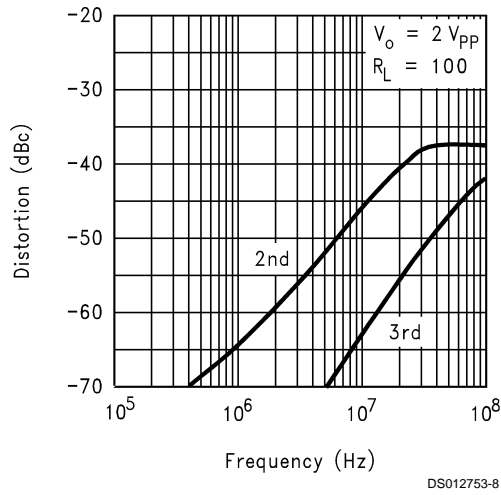

2-Tone, 3rd Order, Intermodulation Intercept

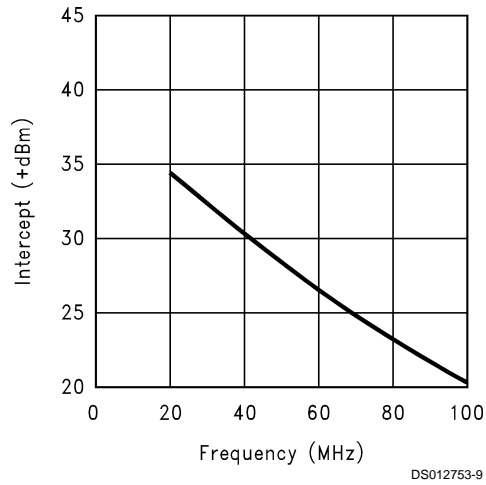

Equivalent Input Noise

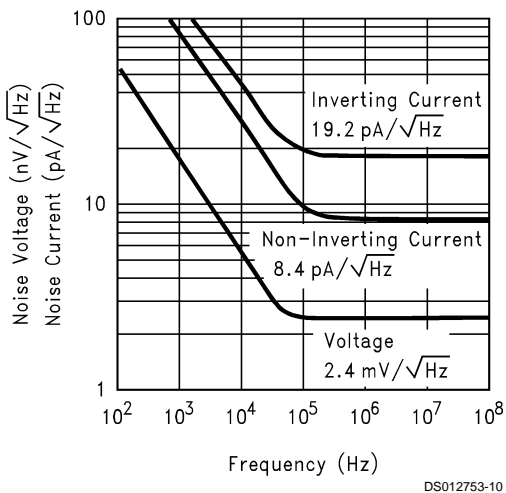

CMRR and PSRR

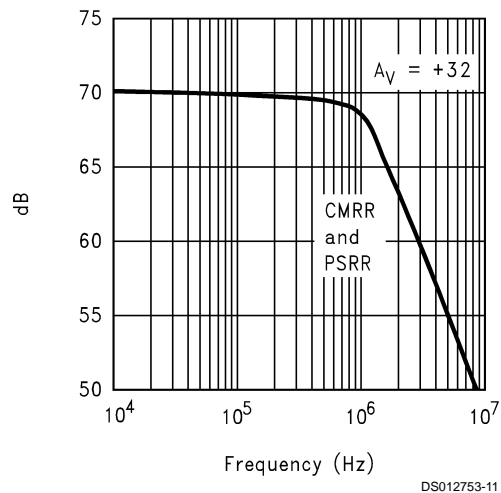

Typical Performance Characteristics ($T_A = 25^\circ$, $A_V = +32$, $V_{CC} = \pm 5V$, $R_L = 100\Omega$, $R_f = 1.5\Omega$, $V_H = +3V$, $V_L = -3V$) (Continued)

Clamped Pulse Response

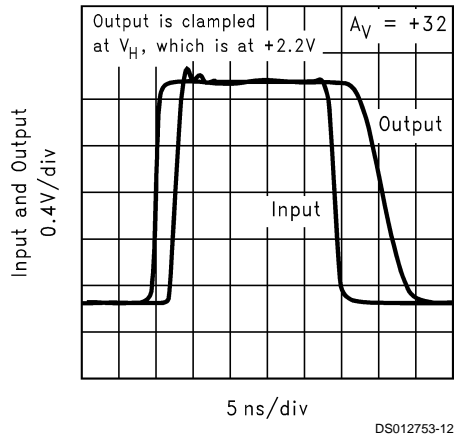

Settling, Clamped (32x overdrive)

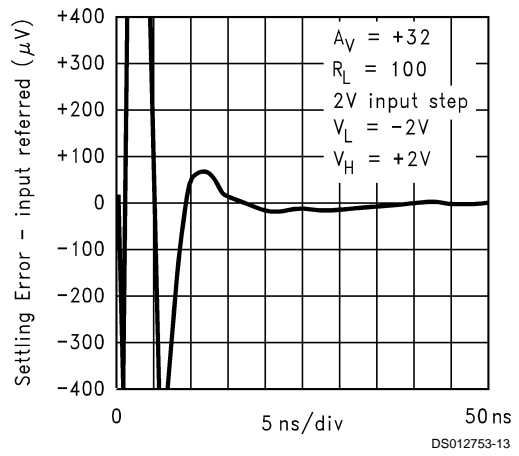

Long-Term Settling, Clamped (32x overdrive)

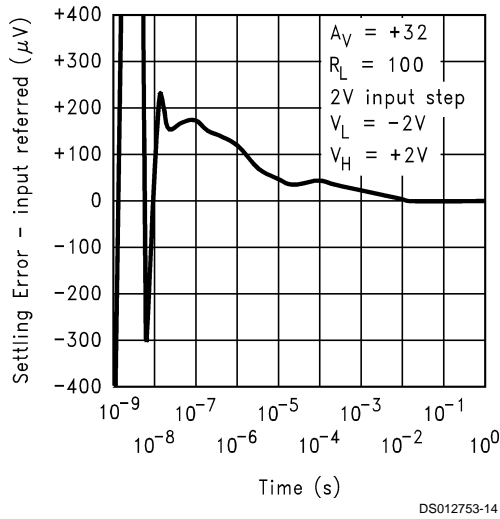

Nonlinearity Near Clamp Voltage

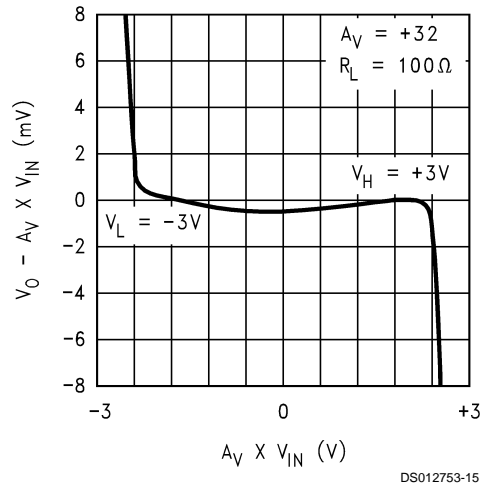

Settling, Unclamped

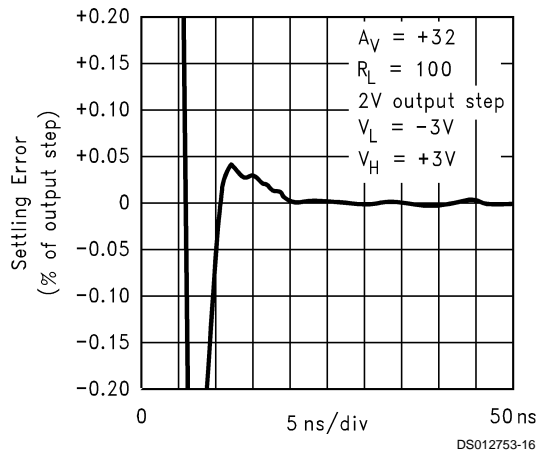

Long-Term Settling, Unclamped

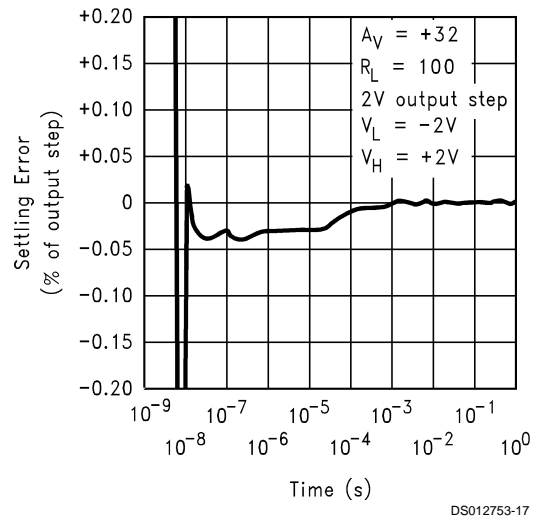

Typical Performance Characteristics ($T_A = 25^\circ$, $A_V = +32$, $V_{CC} = \pm 5V$, $R_L = 100\Omega$, $R_f = 1.5\Omega$, $V_H = +3V$, $V_L = -3V$) (Continued)

Settling Time vs. Capacitive Load

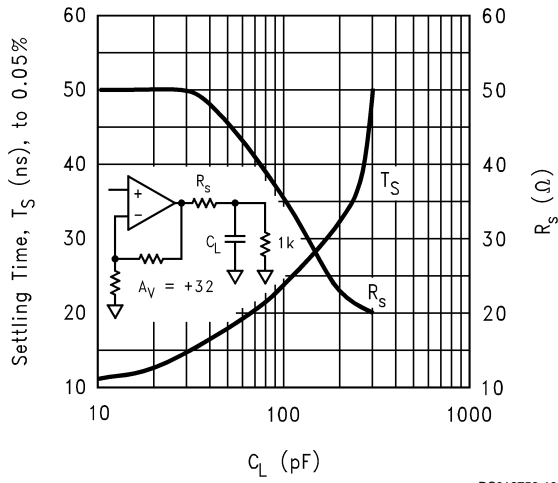

DS012753-18

Application Division

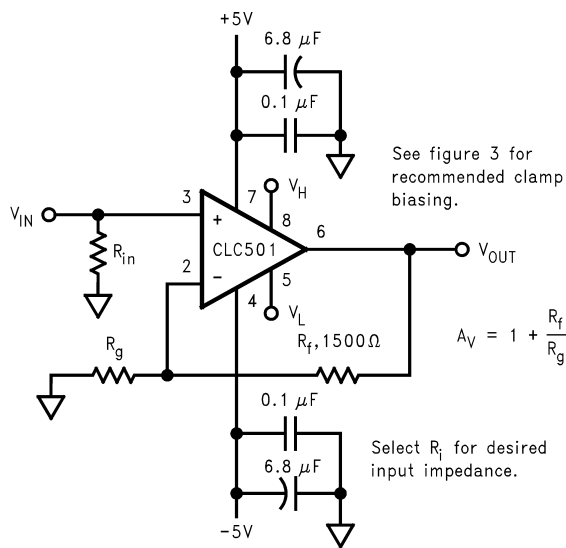

DS012753-19

FIGURE 1. Recommended non-Inverting gain circuit

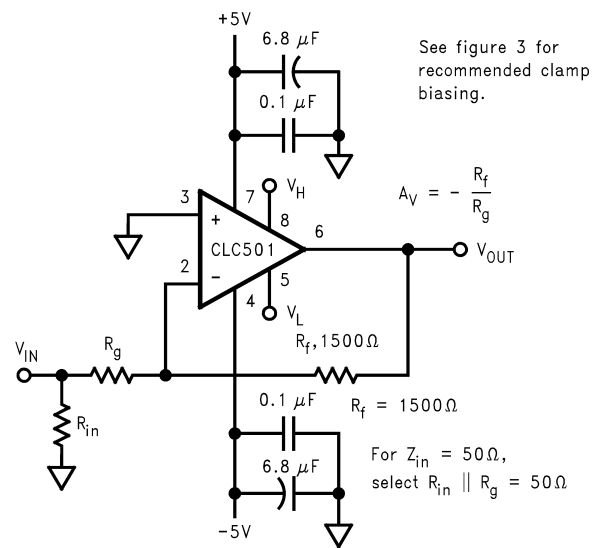

DS012753-20

FIGURE 2. Recommended Inverting gain circuit

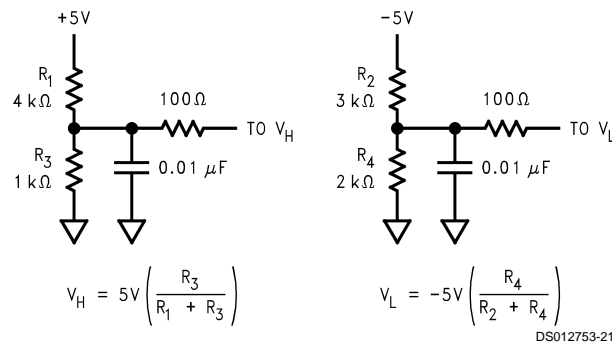

DS012753-21

FIGURE 3. Recommended clamp biasing for clamp levels of +1V and -2V

Application Division (Continued)

Clamp Operation

The maximum positive or negative excursion of the output voltage is determined by voltage applied to the clamping pins, V_H and V_L . V_H determines the positive clamping level; V_L determines the negative level. For example, if V_H is set at +2V and V_L is set at -0.5V the output voltage is restricted within this -0.5V to +2V range. When the output voltage tries to exceed this level, the amplifier goes into "clamp mode" and the output voltage limits at the clamp voltage.

Clamp Accuracy and Amplifier Linearity

Ideally, the clamped output voltage and the clamp voltage should be identical. In practice, however, there are two sources of clamp inaccuracy: the inherent clamp accuracy (which is shown in the specification page) and resistor divider action of open-loop output resistance of 10Ω and the load resistor. Or, in equation form,

$$V_{OUT, CLAMP} = (V_H \text{ or } L \pm 200 \text{ mV}) \frac{R_L}{R_L = 10\Omega} \quad (1)$$

When setting the clamping voltage, the designer should also recognize that within about 200mV of the clamp voltage, amplifier linearity begins to deteriorate. (See plot on the previous page.)

Biasing V_H and V_L

Each of the clamping pins is buffered internally so simple resistive voltage divider circuits work well in providing the clamp voltages (see *Figure 3*). The 100Ω isolating resistor ensures stability when the clamp pin is connected to V_{CC} or when the clamp pins is driven by an external signal source; in other situations, such as the one described in *Figure 3*, the isolating resistor is not necessary.

V_H should be biased more positively than V_L . V_H may be biased below 0V; however, with this biasing, the output voltage will actually clamp at 0V unless a simple pull down circuit is added to the op amp output. (When clamped against V_H , the output cannot sink current.) An analogous situation and design solution exists for V_L when it is biased above 0V, but in this case, a pull up circuit is used to source current when the amplifier is clamped against V_L .

The clamps, which have a bandwidth of about 50MHz, may be driven by high frequency signal source. This allows the clamping level to be modulated, which is useful in many applications such as pulse amplitude modulation. The source resistance of the signal source should be less than 500Ω to ensure stability.

Clamp-Mode Dynamics

As can be seen in the clamped pulse response plot on the previous page, clamping is virtually instantaneous. Note, however, that there can be a small amount of overshoot, as indicated on the specification page. The output voltage stays at the clamp voltage level as long as the product of the input voltage and the gain setting exceeds the clamp voltage. When the input voltage decreases, it will eventually reach a point where it is no longer trying to drive the output voltage above the clamp voltage. When this occurs, there is typically a 1ns "overload recovery from clamp," which is the time it takes for the op amp to resume linear operation. The normal op amp parameters, such as the rise time, apply when the op amp is in linear operation.

When the op amp is in clamp mode for more than about 100ns, a small thermal tail can be detected in the settling

performance. This tail, which has a maximum value of $200\mu\text{V}$ referred to the input, is proportional to the amount of time spent in clamp mode. In most applications, this will have only a minor effect. For example, in a system with a 100ns overdrive occurring with a duty cycle of 10%, the input-referred tail is $20\mu\text{V}$ which is only 0.001% of a 2V signal.

DC Accuracy and Noise

Since the two inputs for the CLC501 are quite dissimilar, the noise and offset error performance differs somewhat from that of a standard differential input amplifier. Specifically, the inverting input current noise is much larger than the non-inverting current noise. Also the two input bias currents are physically unrelated rendering bias current cancellation through matching of the inverting and non-inverting pin resistors ineffective.

In equation 3, the output offset is the algebraic sum of the equivalent input voltage and current sources that influence DC operation. Output noise is determined similarly except that a root-sum-of-squares replaced the algebraic sum. R_s is the non-inverting pin resistance.

PSRR and CMRR

The PSRR and CMRR performance plots on the previous page show performance for a circuit set at a gain of +32 and a source resistance of 0Ω . In current feedback op amps, common mode and power supply variations manifest themselves in changes in the op amp's bias currents (IBI for the inverting input and IBN for the non-inverting input) and in the offset voltage (VIO). At DC, these values are:

$$\begin{aligned} \text{CMRR: } \frac{\Delta V_{IO}}{\Delta V_{cm}} &= 130 \mu\text{V/V} & \text{PSRR: } \frac{\Delta V_{IO}}{\Delta V_{CC}} &= 180 \mu\text{V/V} \\ \frac{\Delta IBN}{\Delta V_{cm}} &= 6 \mu\text{A/V} & \frac{\Delta IBN}{\Delta V_{CC}} &= 3 \mu\text{A/V} \\ \frac{\Delta IBI}{\Delta V_{cm}} &= 2 \mu\text{A/V} & \frac{\Delta IBI}{\Delta V_{CC}} &= 3 \mu\text{A/V} \end{aligned}$$

(2)

The total effect, as reference to the input, is given by the following:

$$\begin{aligned} \text{PSRR: } &= -20 \log \left[\frac{\Delta V_{IO}}{\Delta V_{CC}} + \frac{\Delta IBN}{\Delta V_{CC}} R_s + \frac{\Delta IBI}{\Delta V_{CC}} R_{eq} \right] \\ \text{CMRR: } &= -20 \log \left[\frac{\Delta V_{IO}}{\Delta V_{cm}} + \frac{\Delta IBN}{\Delta V_{cm}} R_s + \frac{\Delta IBI}{\Delta V_{cm}} R_{eq} \right] \end{aligned}$$

(3)

Where R_s is the equivalent resistance seen by the non-inverting input and R_{eq} is the equivalent resistance of R_g in parallel with R_f .

Printed circuit Layout

As with any high frequency device, a good PCB layout will enhance performance. Ground plane construction and good power supply bypassing close to the package are critical to achieving full performance. In the non-inverting configuration, the amplifier is sensitive to stray capacitance to ground at the inverting input. Hence, the inverting node connections should be small with minimal coupling to the ground plane. Shunt capacitance across the feedback resistor should not be used to compensate for this effect.

Evaluation PC boards (part number CLC730013 for through-hole and CLC730027 for SOIC) for the CLC501 are available.

Physical Dimensions inches (millimeters) unless otherwise noted

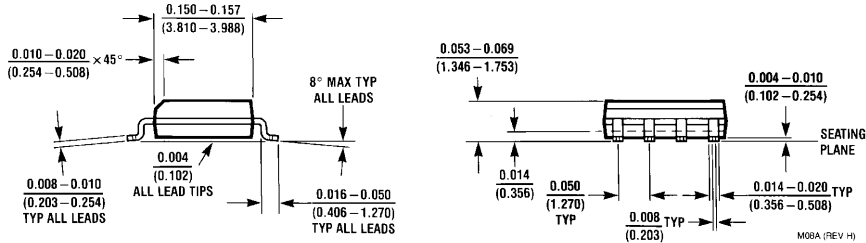
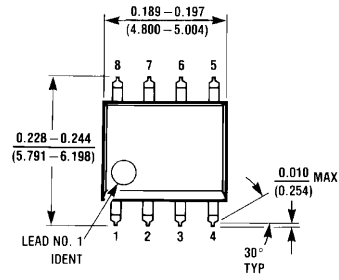

8-Pin SOIC
NS Package Number M08A

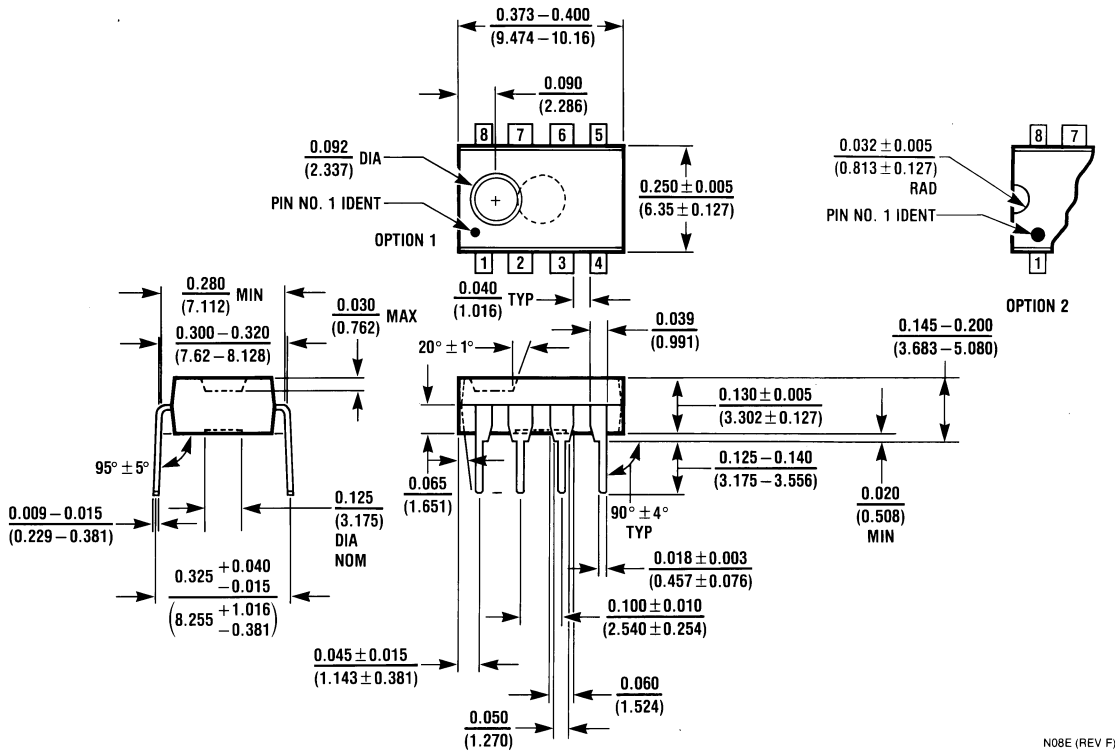

8-Pin MDIP
NS Package Number N08E

Notes

LIFE SUPPORT POLICY

NATIONAL'S PRODUCTS ARE NOT AUTHORIZED FOR USE AS CRITICAL COMPONENTS IN LIFE SUPPORT DEVICES OR SYSTEMS WITHOUT THE EXPRESS WRITTEN APPROVAL OF THE PRESIDENT AND GENERAL COUNSEL OF NATIONAL SEMICONDUCTOR CORPORATION. As used herein:

1. Life support devices or systems are devices or systems which, (a) are intended for surgical implant into the body, or (b) support or sustain life, and whose failure to perform when properly used in accordance with instructions for use provided in the labeling, can be reasonably expected to result in a significant injury to the user.
2. A critical component is any component of a life support device or system whose failure to perform can be reasonably expected to cause the failure of the life support device or system, or to affect its safety or effectiveness.



National Semiconductor Corporation
Americas
Tel: 1-800-272-9959
Fax: 1-800-737-7018
Email: support@nsc.com
www.national.com

National Semiconductor Europe
Fax: +49 (0) 180-530 85 86
Email: europe.support@nsc.com
Deutsch Tel: +49 (0) 69 9508 6208
English Tel: +44 (0) 870 24 0 2171
Français Tel: +33 (0) 1 41 91 8790

National Semiconductor Asia Pacific Customer Response Group
Tel: 65-2544466
Fax: 65-2504466
Email: ap.support@nsc.com

National Semiconductor Japan Ltd.
Tel: 81-3-5639-7560
Fax: 81-3-5639-7507

CLC501 Product Folder

High Speed, Output Clamping Op Amp

General Description	Features	Datasheet	Package & Models	Samples & Pricing	Design Tools	Application Notes
-------------------------------------	--------------------------	---------------------------	--------------------------------------	---------------------------------------	------------------------------	-----------------------------------

Datasheet

Title	Size in Kbytes	Date	View Online	Download	Receive via Email
CLC501 High Speed, Output Clamping Op Amp	307 Kbytes	7-Feb-01	View Online	Download	Receive via Email
CLC501 High Speed, Output Clamping Op Amp (JAPANESE)	373 Kbytes		View Online	Download	Receive via Email
CLC501 Mil-Aero Datasheet MNCLC501A-X	117 Kbytes		View Online	Download	Receive via Email

If you have trouble printing or viewing PDF file(s), see [Printing Problems](#).

Package Availability, Models, Samples & Pricing

Part Number	Package			Status	Models		Samples & Electronic Orders	Budgetary Pricing		Std Pack Size	Package Marking
	Type	Pins	MSL		SPICE	IBIS		Qty	\$US each		
CLC501AJE	SOIC NARROW	8	MSL	Lifetime buy	clc501.cir	N/A	Buy Now	1K+	\$5.9000	rail of 95	[logo]c2cT CLC501AJE
CLC501AJE-TR13	SOIC NARROW	8	MSL	Lifetime buy	clc501.cir	N/A	Buy Now	1K+	\$5.9000	reel of 2500	[logo]c2cT CLC501AJE
CLC501AJ-MIL	CERDIP	8	MSL	Lifetime buy	clc501.cir	N/A				rail of N/A	[logo]cZcSc4cASE CLC501AJ-MIL
CLC501AJ-MPR	CERDIP	8	MSL	Preliminary	clc501.cir	N/A				rail of N/A	[logo]cZcSc4cASE CLC501AJ-MPR PROTO

5962-8997401PA	CERDIP	8	MSL	Lifetime buy	clc501.cir	N/A		25+	\$34.3000	rail of 40	[logo]cZcSc4cASE CLC501AJ-QML 5962-8997401 PA
CLC501AJ	CERDIP	8	MSL	Lifetime buy	clc501.cir	N/A		500+	\$23.7000	rail of 40	[logo]cUcZc2cTcP CLC501AJ
CLC501AWG-MLS	Ceramic SOIC	10	MSL	Preliminary	clc501.cir	N/A				tray of N/A	cZcSc4cA CLC501 AWG-MLS [logo] SE

General Description

The CLC501 is a high speed current-feedback op amp with the unique feature of output voltage clamping. This feature allows both the maximum positive (V_{HIGH}) and negative (V_{LOW}) output voltage levels to be established. This is useful in a number of applications in which "downstream" circuitry must be protected from over driving input signals. Not only can this prevent damage to downstream circuitry, but can also reduce time delays since saturation is avoided. The CLC501's very fast 1ns overload/clamping recovery time is useful in applications in which information containing signals follow overdriving signals.

Engineers designing high resolution, subranging A/D systems have long sought an amplifier capable of meeting the demanding requirements of the residue amplifier function. Amplifiers providing the residue function must not only settle quickly, but recover from overdrive quickly, protect the second stage A/D, and provide high fidelity at relatively high gain settings. The CLC501, which excels in these areas, is the ideal design solution in this onerous application. To further support this application, the CLC501 is both characterized and tested at a gain setting of +32-the most common gain setting for residue amplifier applications.

The CLC501's other features provide a quick, high performance design solution. Since the CLC501's current feedback design requires no external compensation, designers need not spend their time designing compensation networks. The small 8-pin package and low, 180mW power consumption make the CLC501 ideal in numerous applications having small power and size budgets.

The CLC501 is available in several versions to meet a variety of requirements. A three letter suffix determines the version:

Enhanced Solutions (Military/Aerospace)

SMD Number: 5962-94597

*Space level version also available.

*For more information, visit <http://www.national.com/mil>

Features

- Output clamping (V_{HIGH} and V_{LOW})
- 1ns recovery from clamping/overdrive
- 0.05% settling in 12ns
- Characterized and guaranteed at $A_V = +32$
- Low power: 180mW

Applications

- Residue amplifier in high accuracy, subranging A/D systems
- High speed communications
- Output clamping applications
- Pulse amplitude modulation systems

Design Tools

Title	Size in Kbytes	Date	<input type="checkbox"/> View Online	<input type="checkbox"/> Download	<input type="checkbox"/> Receive via Email
Amplifiers Selection Guide software for Windows	7 Kbytes	12-Jun-2002	View		
CLC730013EB 8-pin Op Amp Evaluation Board	130 Kbytes	15-May-2001	View Online	Download	Receive via Email
CLC730027EB 8-Pin SOIC Evaluation Board	130 Kbytes	15-May-2001	View Online	Download	Receive via Email

If you have trouble printing or viewing PDF file(s), see [Printing Problems](#).

Application Notes

Title	Size in Kbytes	Date	<input type="checkbox"/> View Online	<input type="checkbox"/> Download	<input type="checkbox"/> Receive via Email
CLC730013EB: CLC730013EB/CLC730027EB/CLC730077EB 8-pin Op Amp Evaluation Boards	130 Kbytes	2-Jan-01	View Online	Download	Receive via Email
CLC730027EB: CLC730013EB/CLC730027EB/CLC730077EB 8-pin Op Amp Evaluation Boards	130 Kbytes	2-Jan-01	View Online	Download	Receive via Email
CLC730077EB: CLC730013EB/CLC730027EB/CLC730077EB 8-pin Op Amp Evaluation Boards	130 Kbytes	2-Jan-01	View Online	Download	Receive via Email
OA-07: OA-07 Current- Feedback Op Amp Applications Circuit Guide	308 Kbytes	28-Oct-96	View Online	Download	Receive via Email
OA-11: OA-11 A Tutorial on Applying Op Amps to RF Applications	769 Kbytes	2-Apr-99	View Online	Download	Receive via Email
OA-12: OA-12 Noise Analysis for Comlinear's Op Amps	108 Kbytes	24-Feb-99	View Online	Download	Receive via Email
OA-13: OA-13 Current- Feedback Loop Gain Analysis	527 Kbytes	28-Oct-96	View Online	Download	Receive via Email
OA-14: OA-14 Improving Amplifier Noise Figure for High 3rd Intercept Amplifiers	92 Kbytes	15-Dec-00	View Online	Download	Receive via Email
OA-15: OA-15 Frequent Faux Pas in Applying Wideband Current Feedback Amplifiers	527 Kbytes	28-Jan-99	View Online	Download	Receive via Email
OA-18: OA-18 Simulation SPICE Models for Comlinear's Op Amps	337 Kbytes	23-May-00	View Online	Download	Receive via Email

OA-20: OA-20 Current Feedback Myths Debunked	139 Kbytes	10-Jul-97	View Online	Download	Receive via Email
OA-23: OA-23 CLC522 Advanced Operating Considerations and Military Specifications	250 Kbytes	29-Oct-99	View Online	Download	Receive via Email
OA-25: OA-25 Stability Analysis of Current Feedback Amplifier	262 Kbytes	10-Oct-96	View Online	Download	Receive via Email
OA-30: OA-30 Current vs. Voltage Feedback Amplifiers	56 Kbytes	5-Jun-98	View Online	Download	Receive via Email

If you have trouble printing or viewing PDF file(s), see [Printing Problems](#).

[Information as of 5-Aug-2002]

[Search](#) **[Design](#)** **[Purchasing](#)** **[Quality](#)** **[Company](#)** **[Home](#)**

[About Languages](#) . [Website Guide](#) . [About "Cookies"](#) . National is [QS 9000 Certified](#) . [Privacy/Security Statement](#) . [Contact Us](#) . [Site Terms & Conditions of Use](#) . Copyright 2002 © National Semiconductor Corporation . [My Preferences](#) . [Feedback](#)