

EMD-BL-V-230(-PT)

Electronic monitoring relay for undervoltage monitoring of direct and alternating voltages in single-phase networks



Data sheet
105671_en_01

© PHOENIX CONTACT - 2016-03-22

1 Description

Safety and system availability requirements are constantly on the increase – across all industries. Processes are becoming more and more complex, not only in machine building and the chemical industry but also in building technology. The demands placed on energy technology are also constantly on the rise.

It is only by continuously monitoring key network and system parameters that error-free and therefore cost-effective operation can be achieved. Electronic monitoring relays from the EMD series are available for a wide range of monitoring tasks so that the consequences of errors can be avoided or kept within limits.

The operating states are signaled via color LEDs and any errors that occur can be sent to a controller via a floating contact or can shut down a section of the system. All device versions are equipped with response delays so that measured values outside the set monitoring range can be briefly tolerated.

Features

- Undervoltage monitoring
- Adjustable threshold values
- Adjustable hysteresis
- Adjustable response delay
- Window function
- Supply voltage from the measuring circuit
- One PDT



WARNING: Risk of electric shock

Never carry out work when voltage is present.



Make sure you always use the latest documentation.
It can be downloaded from the product at phoenixcontact.net/products.

2 Ordering data

| Description | Type | Order No. | Pcs./Pkt. |
|---|-----------------|-----------|-----------|
| Electronic monitoring relay for undervoltage monitoring of direct and alternating voltages in single-phase networks | EMD-BL-V-230-PT | 2903524 | 1 |
| Electronic monitoring relay for undervoltage monitoring of direct and alternating voltages in single-phase networks | EMD-BL-V-230 | 2903523 | 1 |

3 Technical data

| Input data | |
|---------------------------------------|--|
| Input name | Measuring input |
| Measured value | DC, AC sine (48 Hz ... 63 Hz) |
| Input voltage range | 0 V DC ... 24 V DC (connection terminal blocks: U1 and GND) 0 V AC ... 24 V AC (connection terminal blocks: U2 and GND) 0 V AC ... 230 V AC (connection terminal blocks: U3 and GND) |
| Min. setting range | 75 % ... 115 % (From U_N) |
| Max. setting range | 80 % ... 120 % (From U_N) |
| Maximum temperature coefficient | ≤ 0.05 % |
| Setting range for response delay | 0.1 s ... 10 s |
| Function | Undervoltage, window |
| Basic accuracy | ≤ 5 % (of scale end value) |
| Setting accuracy | ± 5 % (of scale end value) |
| Repeat accuracy | ≤ 2 % |
| Recovery time | > 500 ms |
| Output data | |
| Contact type | 1 floating PDT |
| Maximum switching voltage | 250 V AC (in acc. with IEC 60664-1) |
| Interrupting rating (ohmic load) max. | 1250 VA (5 A/250 V AC) |
| Output fuse | 5 A (fast-blow) |
| Supply | |
| Supply voltage | -25 % ... +20 % (= measuring voltage) |
| Frequency range | 48 Hz ... 63 Hz |
| Nominal power consumption | 10 VA (At 230 V AC (0.6 W)) |
| General data | |
| Mains type | 1-phase |
| Operating voltage display | Green LED |
| Status display | Yellow LED |
| Indication | Red LED |
| Mechanical service life | 15×10^6 cycles |
| Service life, electrical | 1×10^5 cycles |
| Switching frequency | ≤ 6 (per minute at 1250 VA ohmic load) |
| Operating mode | 100% operating factor |
| Degree of protection | IP40 (housing) / IP20 (connection terminal blocks) |
| Degree of pollution | 2 (DIN EN 60947-5-1) |
| Overvoltage category | III, 300 V basic insulation (DIN EN 60947-5-1) |
| Rated insulation voltage | 300 V (Supply circuit/measuring circuit (DIN EN 60947-5-1)) |
| Mounting | on standard DIN rail NS 35 in accordance with EN 60715 |

General data [...]

| | |
|-------------------|------------------------------------|
| Mounting position | any |
| Width | 17.5 mm |
| Height | 88 mm |
| Depth | 65.5 mm |
| Type of housing | Polyamide PA66, self-extinguishing |
| Color | gray |

Connection data

| | Push-in connection | Screw connection |
|-----------------------------------|--|---|
| Conductor cross section, solid | 0.14 mm ² ... 2.5 mm ² | 0.5 mm ² ... 2.5 mm ² |
| Conductor cross section, flexible | 0.14 mm ² ... 2.5 mm ² | 0.5 mm ² ... 2.5 mm ² |
| AWG | 26 ... 14 | 20 ... 14 |
| Stripping length | 8 mm | 8 mm |
| Tightening torque | | 1 Nm |

Ambient conditions

| | |
|---|-----------------------------|
| Ambient temperature (operation) | -25 °C ... 55 °C |
| Ambient temperature (storage/transport) | -25 °C ... 70 °C |
| Permissible humidity (operation) | 15 % ... 85 % |
| Climatic class | 3K3 (in acc. with EN 60721) |

Conformance / approvals

| | |
|------------------|--|
| Conformance | CE-compliant |
| UL, USA / Canada |  ENEC |
| UL, USA / Canada | UL/C-UL listed UL 508 |

Conformance with EMC Directive 2004/108/EC

| | |
|-----------------------------|--------------|
| Noise immunity according to | EN 61000-6-2 |
| Noise emission according to | EN 61000-6-3 |

Conformance with LV directive 2006/95/EC

| | |
|-------------------------------------|--------------|
| Low voltage switchgear according to | EN 60947-5-1 |
|-------------------------------------|--------------|

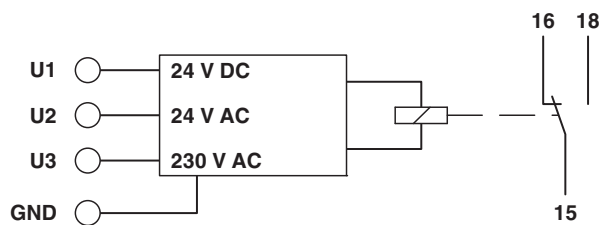
4 Block diagram**5 Safety notes****WARNING: Risk of electric shock**

Never carry out work when voltage is present.

6 Structure

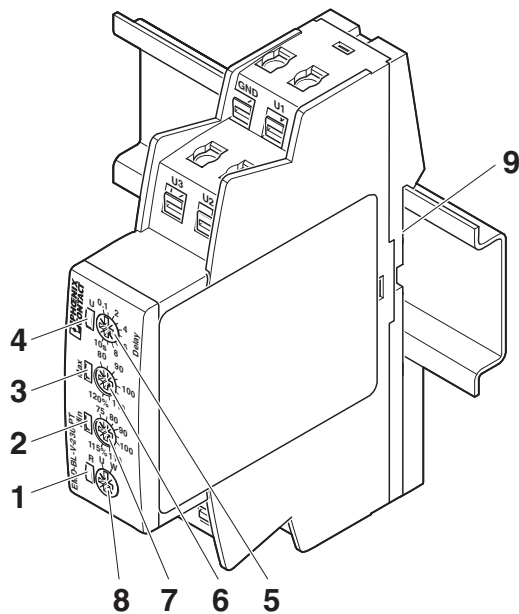

- 1 LED: output relay R
- 2 LED: minimum threshold value (Min)
- 3 LED: maximum threshold value (Max)
- 4 LED: supply U
- 5 "DELAY" potentiometer: Response delay
- 6 "MAX" potentiometer: Upper threshold value
- 7 "MIN" potentiometer: Lower threshold value
- 8 Rotary switch for function selection
- 9 Snap-on foot for DIN rail mounting

7 Installation



WARNING: Risk of electric shock

Never carry out work when voltage is present.

The module can be snapped onto all 35 mm DIN rails according to EN 60715.

8 Diagnostics

The LEDs indicate the following error states:

"U" LED (Green)

- LED ON: Supply voltage present

"MIN" and "MAX" LEDs (Red)

- LED flashing: indicates response delay for the corresponding threshold
- LED ON: indicates error for the corresponding threshold

"R" LED (yellow)

- LED ON: Output relay has picked up
- LED OFF: Output relay has dropped out

9 Connection examples

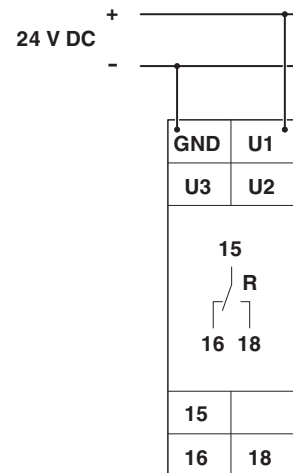
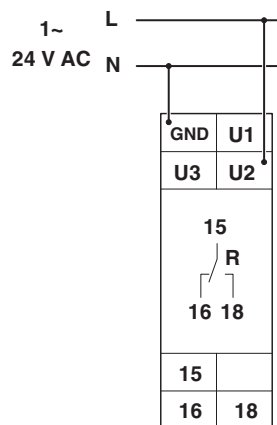
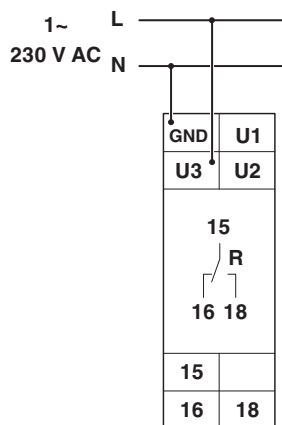

10 Function

The "FUNCTION" rotary switch is used to set the desired function:

- U = Undercurrent monitoring (UNDER)
- W = Monitoring of the area between thresholds MIN and MAX (window function) (WIN)

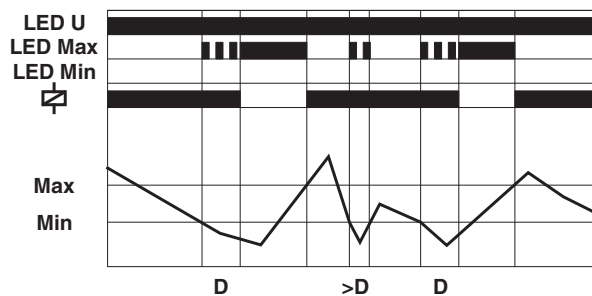

Undervoltage Monitoring (UNDER)

When supply voltage U is applied, output relay "R" picks up (yellow "R" LED is ON).

If the measured voltage falls below the value set at the "MIN" controller, the set response delay ($D = \text{DELAY}$) starts (red "MIN" LED flashes). After the delay time has elapsed (red "MIN" LED is ON), output relay "R" drops out (yellow "R" LED is OFF). If the measured voltage exceeds the value set at the "MAX" controller, output relay "R" picks up again (yellow "R" LED is ON).

The "MIN" and "MAX" LEDs flash alternately if the minimum value selected for the measured voltage is greater than the maximum value.

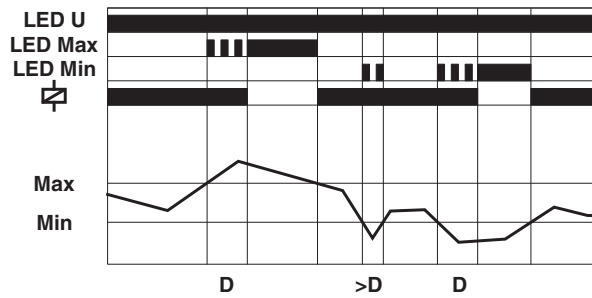

Window Function (WIN)

Output relay "R" picks up (yellow "R" LED is ON) if the measured voltage exceeds the value set at the "MIN" controller. If the measured voltage exceeds the value set at the "MAX" controller, the set response delay ($D = \text{DELAY}$) starts (red "MAX" LED flashes). After the delay time has elapsed (red "MAX" LED is ON), output relay "R" drops out (yellow "R" LED is OFF).

Output relay "R" picks up again (yellow "R" LED is ON) if the measured voltage falls below the maximum value again (red "MAX" LED is OFF). If the measured voltage falls below the value set at the "MIN" controller, the set response delay ($D = \text{DELAY}$) starts (red "MIN" LED flashes). After the delay time has elapsed (red "MIN" LED is ON), output relay "R" drops out (yellow "R" LED is OFF).