

Mechanical Dimensions: Inches [mm]

Tolerances ± 0.012 [0.3] Unless Otherwise Specified

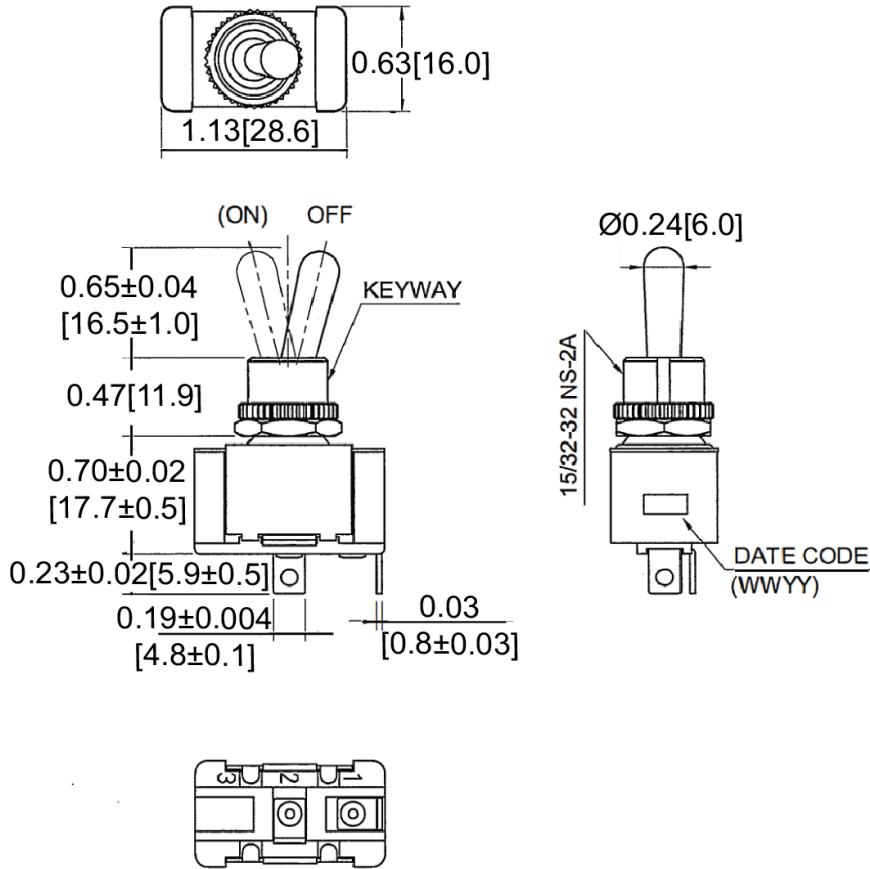

Mounting Hole

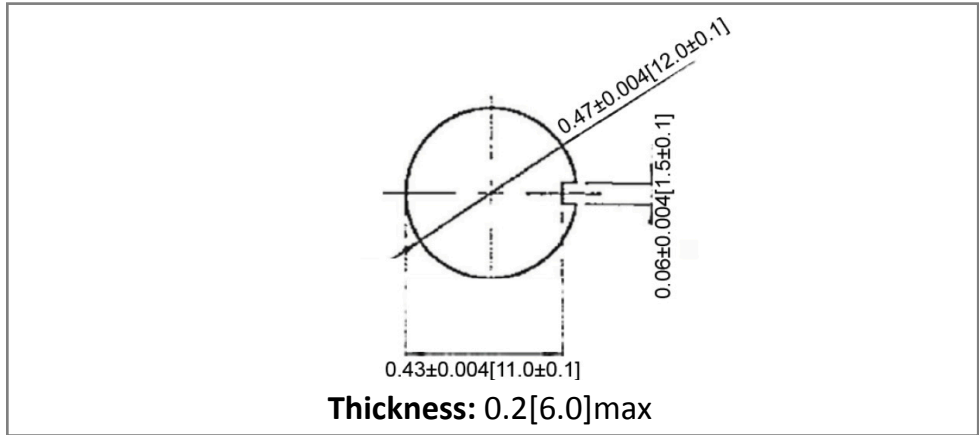

Circuit Diagram

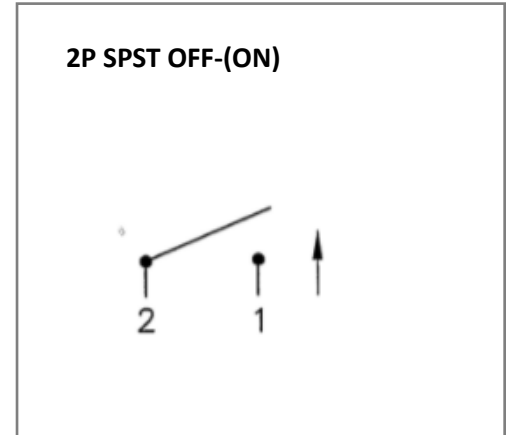

Electrical Specifications

Rating	21A 14V DC
Contact Resistance	50m ohm Max
Insulation Resistance	DC 500V 100M ohm Min
Dielectric Strength	AC 1500V 1 minute
Operation Temperature	-20°C ~ 85°C

Material Specifications

Operation Force	1100gf ± 400 gf
	1 hex nut assy
	1 knurl nut assy

Rev	Date of issue	Revision Notes	Designed	Approved
B	02-18-2020	Initial Drawing	RC	OF