



TR220M SERIES 220 WATT MEDICAL SWITCH ADAPTER

Features

- Universal Input Range 80~264Vac
- High Efficiency up to 94%
- Class I (TR220MA), Class II (TR220MB)
- No Load Input Power Consumption < 150mW
- Approval IEC/EN/UL 60601-1 2 MOPP
- Approval IEC/EN 60601-1-11 (TR220MB)
- Approval EN55011 and CISPR/FCC Class B
- Approval IP22
- Operating Altitude 5000m
- Continuous Short Circuit Protection
- Over Voltage Protection
- Meets CoC Tier 2 and DOE Level VI



MODEL NUMBER	OUTPUT VOLTAGE	OUTPUT CURRENT	RIPPLE & NOISE NOTE1	VOLTAGE ACCURACY NOTE2	LINE REGULATION NOTE3	LOAD REGULATION NOTE4	%EFF. (Typ.) NOTE5
TR220MA120	12 V	16.67 A	120mV	±2%	±1%	±4%	91%
TR220MA240	24 V	9.17 A	200mV	±2%	±1%	±3%	93%
TR220MA360	36 V	6.11 A	200mV	±2%	±1%	±2%	93%
TR220MA480	48 V	4.58 A	200mV	±2%	±1%	±2%	94%
TR220MA560	56 V	3.93 A	200mV	±2%	±1%	±2%	94%
TR220MB120	12 V	16.67A	120mV	±2%	±1%	±4%	91%
TR220MB240	24 V	9.17 A	200mV	±2%	±1%	±3%	93%
TR220MB360	36 V	6.11 A	200mV	±2%	±1%	±2%	93%
TR220MB480	48 V	4.58 A	200mV	±2%	±1%	±2%	94%
TR220MB560	56 V	3.93 A	200mV	±2%	±1%	±2%	94%

Note:

1. Add a 0.1uF ceramic capacitor and a 10uF E.L. capacitor to output for ripple & noise measuring @20MHz BW.
2. Voltage accuracy is set at 60% full load.
3. Line regulation is measured from 100V_{ac} to 240V_{ac} with full load.
4. Load regulation measured from 60% to 100% full load and from 60% to 20% full load (60%±40% full load).
5. Typical efficiency at 230V_{ac} and 75% full load at 25°C.

PART NUMBER

Series		Output Voltage	DC Plug Type	Cable Type	Cable Length
TR220M	X	XXX	-XX	E	XX
220W Medical Adapter	A : Class I B : Class II	120 : 12V	See Page 6	E : UL2464 with OVP	471 : 950mm with Ferrite Core 12 : 1220mm with Ferrite Core 13 : 1800mm with DC Jack See page 6 restrictions
		240 : 24V			
		360 : 36V			
		480 : 48V			
		560 : 56V			

Part Number Example:

TR220MA240-1538E12, 220W, Class I, 24V_{dc} Output, Din Power Plug Molded Type, Cable Length 1220mm

TR220MB360-11E13, 220W, Class II, 36V_{dc} Output, DC Jack Type, Cable Length 1800mm



TR220M Series

TECHNICAL SPECIFICATIONS

(All specifications are typical at nominal input, full load at 25°C unless otherwise noted.)

ABSOLUTE MAXIMUM RATINGS

PARAMETER	NOTES and CONDITIONS	Device	Min.	Typ.	Max.	Units
Input Voltage		All	80		264	V _{ac}
Operating Temperature	See Derating Curve	All	-30		70	°C
Storage Temperature		All	-40		85	°C
Input/Output Isolation Voltage	1 minute	All	4000			V _{ac}
Operating Altitude		All			5000	m

INPUT CHARACTERISTICS

PARAMETER	NOTES and CONDITIONS	Device	Min.	Typ.	Max.	Units
Operating Voltage Range		All	100		240	V _{ac}
Input Frequency Range		All	47		63	Hz
Maximum Input Current	100% Load, V _{in} =100V _{ac}	All			2.5	A
Leakage Current (Earth)		All			300	uA
Leakage Current (Touch)		All			100	uA
Under Voltage Protection		All	50	60	65	V
Power Factor	230V _{ac} /50Hz @ Full load	All	0.92			

OUTPUT CHARACTERISTICS

PARAMETER	NOTES and CONDITIONS	Device	Min.	Typ.	Max.	Units
Output Voltage Set Point	V _{in} =115V _{ac} and 230V _{ac} , I _o =60% Full load T _c =25°C	TR220MA/B120	11.76	12	12.24	V _{dc}
		TR220MA/B240	23.52	24	24.48	
		TR220MA/B360	35.28	36	36.72	
		TR220MA/B480	47.04	48	48.96	
		TR220MA/B560	54.88	56	57.12	
Operating Output Current Range	V _{in} =115V _{ac} and 230V _{ac} , T _c =25°C	TR220MA/B120	0		16.67	A
		TR220MA/B240	0		9.17	
		TR220MA/B360	0		6.11	
		TR220MA/B480	0		4.58	
		TR220MA/B560	0		3.93	
Holdup Time	V _{in} =115V _{ac}	All	20	22		ms
Output Voltage Regulation						
Load Regulation	60%±40% Full load change	TR220MA/B120			±4	%
		TR220MA/B240			±3	
		TR220MA/B360			±2	
		TR220MA/B480			±2	
		TR220MA/B560			±2	
Line Regulation	V _{in} =High line to low line	All			±1	%
Over Voltage Protection	Latch Off	TR220MA/B120		13.5		V _{dc}
		TR220MA/B240		30		
		TR220MA/B360		42		
		TR220MA/B480		56		
		TR220MA/B560		59.2		
Output Ripple and Noise	1. Add a 0.1uF ceramic capacitor and a 10uF aluminum electrolytic capacitor to output 2. Oscilloscope is 20MHz band width 3. Ambient temperature=25°C	TR220MA/B120			120	mV
		TR220MA/B240			200	
		TR220MA/B360			200	
		TR220MA/B480			200	
		TR220MA/B560			200	



TR220M Series

PARAMETER	NOTES and CONDITIONS	Device	Min.	Typ.	Max.	Units
Load Capacitance	1. $V_{in}=115V_{ac}$ and $230V_{ac}$ 2. Output is max. load 3. Ambient temperature= $25^{\circ}C$	TR220MA/B120			16500	uF
		TR220MA/B240			9270	
		TR220MA/B360			6160	
		TR220MA/B480			4540	
		TR220MA/B560			4070	
Efficiency	1. $V_{in}=230V_{ac}$ 2. Output is 75% full load 3. Ambient temperature= $25^{\circ}C$	TR220MA/B120		91%		%
		TR220MA/B240		93%		
		TR220MA/B360		93%		
		TR220MA/B480		94%		
		TR220MA/B560		94%		

ISOLATION CHARACTERISTICS

PARAMETER	NOTES and CONDITIONS	Device	Min.	Typ.	Max.	Units
Input to Output	1 minute (without dielectric breakdown)	All			4400	V_{ac}
Input to Earth (Ground)	1 minute (without dielectric breakdown)	All			1800	V_{ac}
Output to Earth (Ground)	1 minute (without dielectric breakdown)	All			1800	V_{ac}
Isolation Resistance	Input to output	All	100			M Ω

FEATURE CHARACTERISTICS

PARAMETER	NOTES and CONDITIONS	Device	Min.	Typ.	Max.	Units
Switching Frequency		All		100		kHz

GENERAL SPECIFICATIONS

PARAMETER	NOTES and CONDITIONS	Device	Min.	Typ.	Max.	Units
MTBF	$I_o=100\%$; $T_a=25^{\circ}C$ per MIL-HDBK-217F	All	585			k hours
Life Time	@ 75% Load, $40^{\circ}C$	All	26			k hours
Humidity	Non-condensing	All			93	% RH
Shock	MIL-STD-810F Table 516.5, TABLE 516.5-1 10ms, each axis 3 times($\pm X$ 、 $\pm Y$ 、 $\pm Z$ axis)	All		75		g
Vibration	MIL-STD-810F Table 514.5C-VIII, 15~2000Hz, X、Y、Z axis, 1 hour(each axis),. total 3 hours.	All		4		g
Weight		All		950		grams
Dimension		All	7.087x2.953x1.752 Inches (180x75x44.5mm)			
Safety	Class I, Class II, IEC60601-1, EN60601-1, ANSI/AAMI ES60601-1 IEC/EN 60601-1-11 for TR220MB (Home Health Care)					Ed 3.1
EMC Emission	EN55011:2016+A1:2017, EN61000-3-2:2014, EN6100-3-3:2013, FCC CFR47 Part 15					
Conducted Disturbance	EN55011:2016+A1:2017, FCC CFR47 Part 15					Class B
Radiated Disturbance	EN55011:2016+A1:2017, FCC CFR47 Part 15					Class B
Harmonic Current Emissions	EN 61000-3-2:2014					Class A
Voltage Fluctuations & Flicker	EN 61000-3-3:2013					Criterion A
EMC Immunity	EN60601-1-2:2015, IEC61000-4-2, 3, 4, 5, 6, 8, 11					Ed 4.0
Electrostatic Discharge (ESD)	IEC 61000-4-2:2008 Air Discharge: $\pm 15kV$ Contact Discharge: $\pm 8kV$					Criterion A
Radio-Frequency, Continuous Radiated Disturbance	IEC 61000-4-3:2020					Criterion A
Electrical Fast Transient (EFT)	IEC61000-4-4:2012, $\pm 1kV$, $\pm 2kV$					Criterion A
Surge	IEC61000-4-5:2014+A1:2017, L-N: $\pm 0.5kV$, $\pm 1kV$, $\pm 2kV$ L-E (Ground): $\pm 0.5kV$, $\pm 1kV$, $\pm 2kV$					Criterion A
Conducted Disturbances, Induced by RF Fields	IEC 61000-4-6:2013+COR1:2015					Criterion A
Power Frequency Magnetic Field	IEC 61000-4-8:2009					Criterion A
Voltage Dips	IEC 61000-4-11:2004+A1:2017, Dips:30% reduction, Dips: >95% Reduction, Criteria A					Criterion A
Voltage Interruptions	IEC 61000-4-11:2004+A1:2017, >95% Reduction					Criterion B
Application Note Link						TR220M Series App Notes



TR220M Series

CHARACTERISTIC CURVE

Power Derating Curve

TR220M Derating Curve

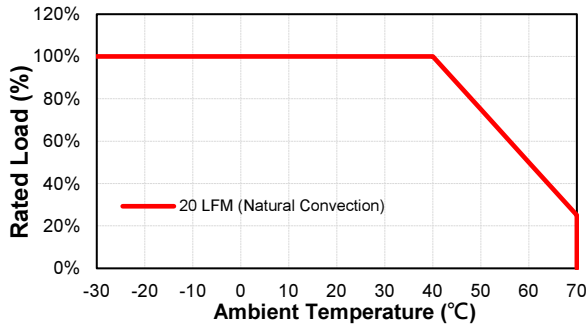

TR220M Input Voltage Derating Curve

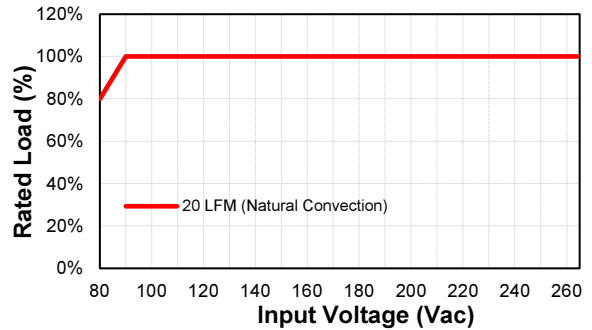

Performance Data

TR220M120 (Eff Vs Io)

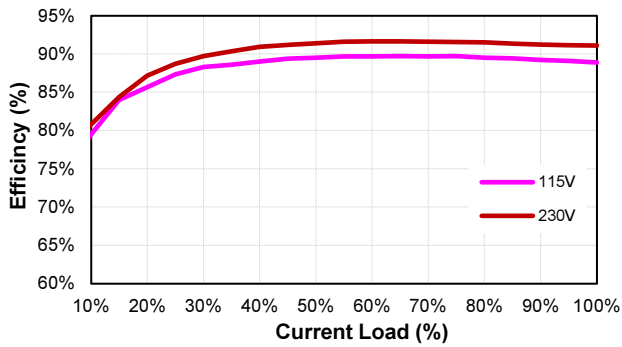

TR220M240 (Eff Vs Io)

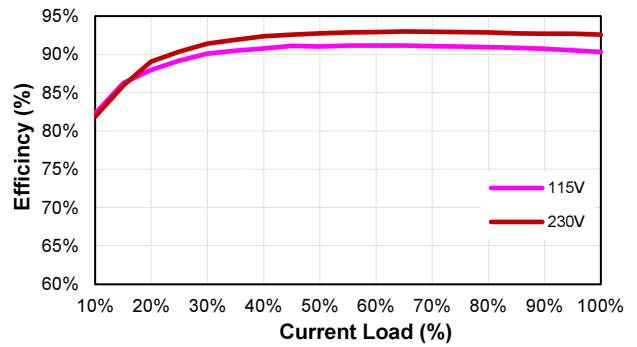

TR220M360 (Eff Vs Io)

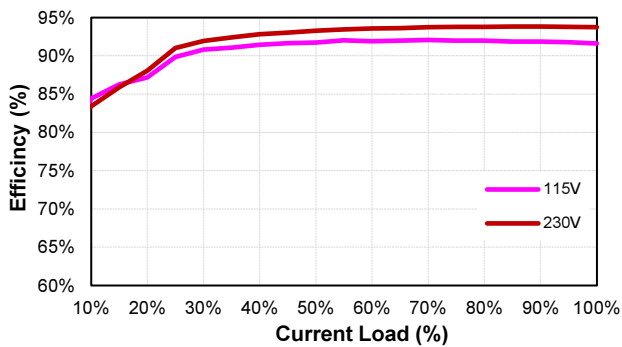

TR220M480 (Eff Vs Io)

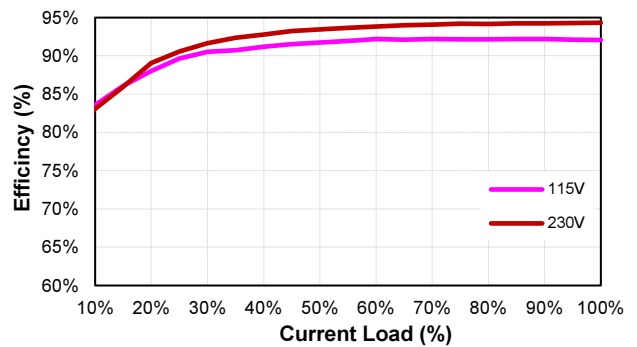

TR220M560 (Eff Vs Io)

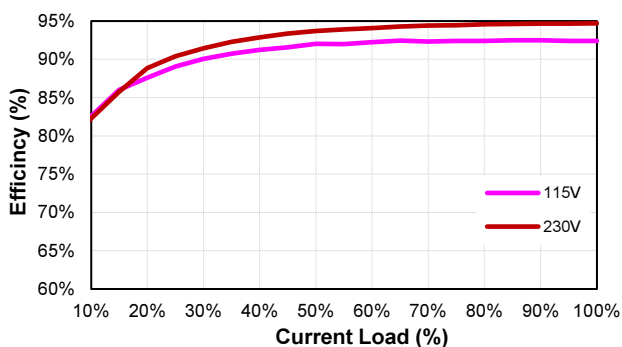



TR220M Series

MECHANICAL SPECIFICATION

All Dimensions are in inches[mm]
 Tolerance: Inches: X.XXX±0.02
 Millimeters: X.XX±0.5
 UNIT: inches[mm]

Din Power Plug

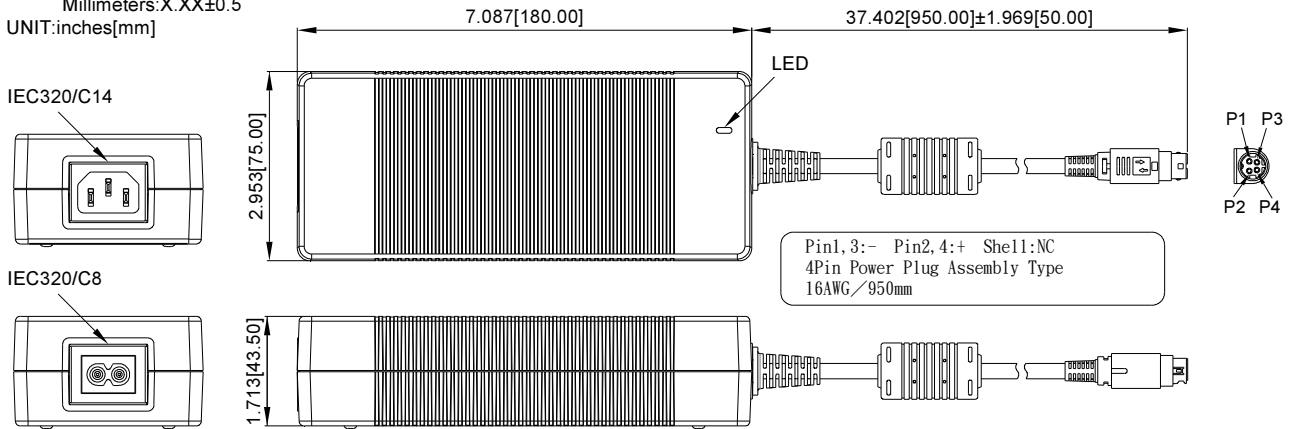

DC Jack

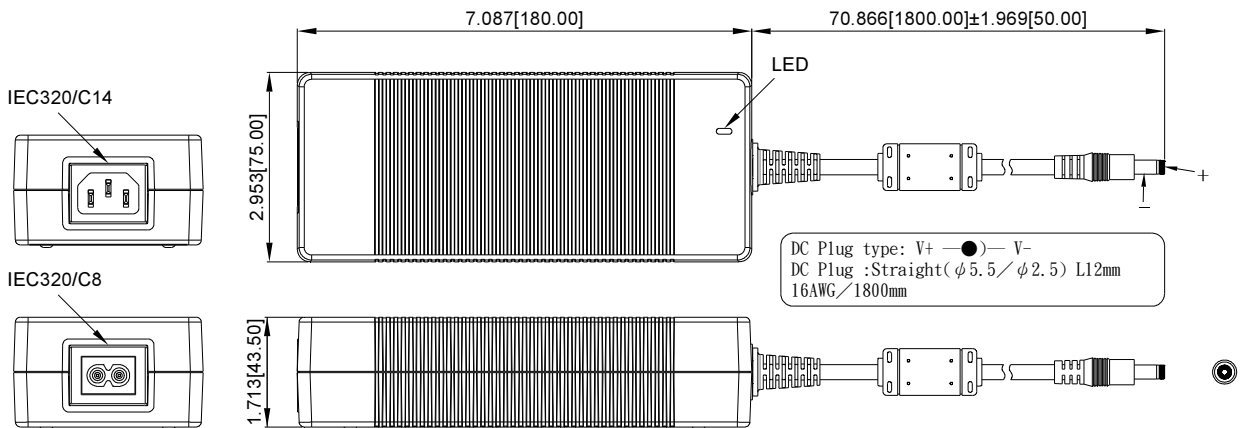

* For Output Voltage 12Vdc and 24V model, it must select Din Power Plug Molded Type or equivalent

* For Output Voltage 36Vdc to 56Vdc models, it's able to select Din Power Plug Molded Type, DC Jack or equivalent.



TR220M Series

STANDARD OUTPUT DC PLUG

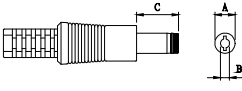
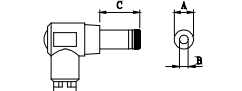
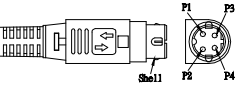
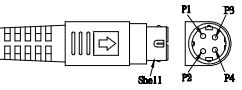
DC Plug Type	Cable Number-XXXXX	A	B	C	Cable Type	Cable Length	Cable AWG
		OD (mm)	ID (mm)	L (mm)			
 <p>Straight/Inner+Outer-</p> <p>+ ● -</p>	11E13	Φ5.5	Φ2.1	12	UL2464	1800mm with Ferrite Core	16AWG for 36V,48V,56V
	12E13	Φ5.5	Φ2.5	12			
	23E13	Φ5.5	Φ2.1	9.5			
	26E13	Φ5.5	Φ2.5	9.5			
 <p>Right Angle/Inner+Outer-</p> <p>+ ● -</p>	01E13	Φ5.5	Φ2.1	12			
	02E13	Φ5.5	Φ2.5	12			
	21E13	Φ5.5	Φ2.5	9.5			
	24E13	Φ5.5	Φ2.1	9.5			
Din Plug Type	Cable Number -XXXXX	Pin Assignment		Cable Type	Cable Length	Cable AWG	
		PIN No.	Polarity				
KYCON KPPX-4P equivalent with Lock (Din Power Plug Assembly Type) 	1446E12	P1	-	UL2464	1200mm with Ferrite Core	16AWG for 24V	
		P2	+				
		P3	-				
	1446E471	P4	+		950mm with Ferrite Core	16AWG for 12V	
		Shell	No Connection				
KYCON KPPX-4P equivalent without Lock (Din Power Plug Molded Type) 	1538E12	P1	+	UL2464	1200mm with Ferrite Core	16AWG for 24V	
		P2	+				
		P3	-				
	1538E471	P4	-		950mm with Ferrite Core	16AWG for 12V	
		Shell	No Connection				

※Other DC Plug Type please refer to the link: <https://www.cincon.com/productdownload/TR220M-cable-DC-plug.pdf>

CINCON Electronics Co. Ltd.
 Add: 14F, No. 306, Sec.4, Hsin Yi Rd., Taipei, Taiwan
 Tel: 886-2-27086210
 Fax: 886-2-27029852
 E-mail: sales@cincon.com.tw
 Web: www.cincon.com