

74ALVC32

Low Voltage Quad 2-Input OR Gate with 3.6V Tolerant Inputs and Outputs

Features

- 1.65V to 3.6V V_{CC} supply operation
- 3.6V tolerant inputs and outputs
- t_{PD} :
 - 2.8ns max for 3.0V to 3.6V V_{CC}
 - 3.1ns max for 2.3V to 2.7V V_{CC}
 - 4.7ns max for 1.65V to 1.95V V_{CC}
- Power-off high impedance inputs and outputs
- Uses patented Quiet Series™ noise/EMI reduction circuitry
- Latchup conforms to JEDEC JED78
- ESD performance:
 - Human body model > 2000V
 - Machine model > 250V

General Description

The ALVC32 contains four 2-input OR gates. This product is designed for low voltage (1.65V to 3.6V) V_{CC} applications with I/O compatibility up to 3.6V.

The ALVC32 is fabricated with an advanced CMOS technology to achieve high-speed operation while maintaining low CMOS power dissipation.

Ordering Information

Order Number	Package Number	Package Description
74ALVC32M	M14A	14-Lead Small Outline Integrated Circuit (SOIC), JEDEC MS-012, 0.150" Narrow
74ALVC32MTC	MTC14	14-Lead Thin Shrink Small Outline Package (TSSOP), JEDEC MO-153, 4.4mm Wide

Device also available in Tape and Reel. Specify by appending suffix letter "X" to the ordering number.

 All packages are lead free per JEDEC: J-STD-020B standard.

Connection Diagram

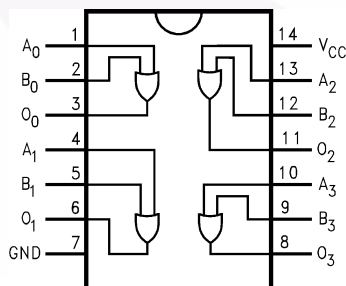

Logic Symbol

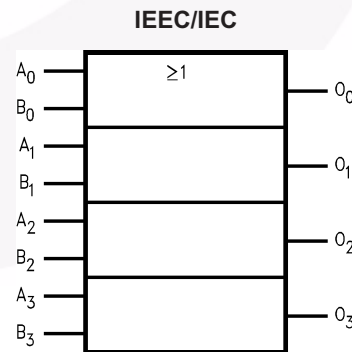

Pin Description

Pin Names	Description
A_n, B_n	Inputs
O_n	Outputs

Absolute Maximum Ratings

Stresses exceeding the absolute maximum ratings may damage the device. The device may not function or be operable above the recommended operating conditions and stressing the parts to these levels is not recommended. In addition, extended exposure to stresses above the recommended operating conditions may affect device reliability. The absolute maximum ratings are stress ratings only.

Symbol	Parameter	Rating
V_{CC}	Supply Voltage	-0.5V to +4.6V
V_I	DC Input Voltage	-0.5V to 4.6V
V_O	Output Voltage ⁽¹⁾	-0.5V to V_{CC} +0.5V
I_{IK}	DC Input Diode Current, $V_I < 0V$	-50mA
I_{OK}	DC Output Diode Current, $V_O < 0V$	-50mA
I_{OH}/I_{OL}	DC Output Source/Sink Current	±50mA
I_{CC} or GND	DC V_{CC} or GND Current per Supply Pin	±100mA
T_{STG}	Storage Temperature Range	-65°C to +150°C

Note:

1. I_O Absolute Maximum Rating must be observed, limited to 4.6V.

Recommended Operating Conditions⁽²⁾

The Recommended Operating Conditions table defines the conditions for actual device operation. Recommended operating conditions are specified to ensure optimal performance to the datasheet specifications. Fairchild does not recommend exceeding them or designing to absolute maximum ratings.

Symbol	Parameter	Rating
V_{CC}	Supply Voltage	1.65V to 3.6V
V_I	Input Voltage	0V to V_{CC}
V_O	Output Voltage	0V to V_{CC}
T_A	Free Air Operating Temperature	-40°C to +85°C
$\Delta V / \Delta t$	Minimum Input Edge Rate: $V_{IN} = 0.8V$ to $2.0V$, $V_{CC} = 3.0V$	5ns/V

Note:

2. Floating or unused control inputs must be held HIGH or LOW.

DC Electrical Characteristics

Symbol	Parameter	V _{CC} (V)	Conditions	Min.	Max.	Units
V _{IH}	HIGH Level Input Voltage	1.65–1.95		0.65 x V _{CC}		V
		2.3–2.7		1.7		
		2.7–3.6		2.0		
V _{IL}	LOW Level Input Voltage	1.65–1.95			0.35 x V _{CC}	V
		2.3–2.7			0.7	
		2.7–3.6			0.8	
V _{OH}	HIGH Level Output Voltage	1.65–3.6	I _{OH} = -100μA	V _{CC} - 0.2		V
		1.65	I _{OH} = -4mA	1.2		
		2.3	I _{OH} = -6mA	2.0		
		2.3	I _{OH} = -12mA	1.7		
		2.7		2.2		
		3.0		2.4		
		3.0	I _{OH} = -24mA	2		
V _{OL}	LOW Level Output Voltage	1.65–3.6	I _{OL} = 100μA		0.2	V
		1.65	I _{OL} = 4mA		0.45	
		2.3	I _{OL} = 6mA		0.4	
		2.3	I _{OL} = 12mA		0.7	
		2.7			0.4	
		3.0	I _{OL} = 24mA		0.55	
I _I	Input Leakage Current	3.6	0 ≤ V _I ≤ 3.6V		±5.0	μA
I _{CC}	Quiescent Supply Current	3.6	V _I = V _{CC} or GND, I _O = 0		10	μA
ΔI _{CC}	Increase in I _{CC} per Input	3–3.6	V _{IH} = V _{CC} - 0.6V		750	μA

AC Electrical Characteristics

Symbol	Parameter	T _A = -40°C to +85°C, R _L = 500Ω								Units
		C _L = 50pF				C _L = 30pF				
		V _{CC} = 3.3V ± 0.3V		V _{CC} = 2.7V		V _{CC} = 2.5V ± 0.2V		V _{CC} = 1.8V ± 0.15V		
		Min.	Max.	Min.	Max.	Min.	Max.	Min.	Max.	
t _{PHL} , t _{PLH}	Propagation Delay	1.0	2.8		2.9	1.0	3.1	1.0	4.7	ns

Capacitance

Symbol	Parameter	Conditions	T _A = +25°C		Units
			V _{CC}	Typical	
C _{IN}	Input Capacitance	V _I = 0V or V _{CC}	3.3	4	pF
C _{PD}	Power Dissipation Capacitance	f = 10MHz, C _L = 50pF	3.3	26	pF
			2.5	24	
			1.8	23	

AC Loading and Waveforms

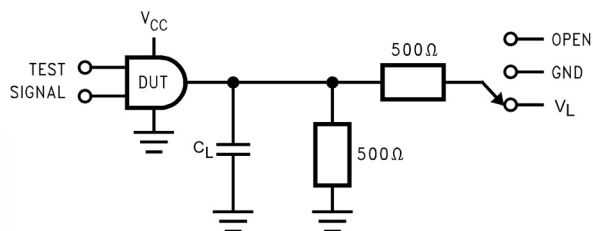

Figure 1. AC Test Circuit

Table 1. Values for Figure 1

Test	Switch
t_{PLH} , t_{PHL}	Open

Table 2. Variable Matrix

(Input Characteristics: $f = 1\text{MHz}$; $t_r = t_f = 2\text{ns}$; $Z_0 = 50\Omega$)

Symbol	V_{CC}			
	$3.3\text{V} \pm 0.3\text{V}$	2.7V	$2.5\text{V} \pm 0.2\text{V}$	$1.8\text{V} \pm 0.15\text{V}$
V_{mi}	1.5V	1.5V	$V_{CC} / 2$	$V_{CC} / 2$
V_{mo}	1.5V	1.5V	$V_{CC} / 2$	$V_{CC} / 2$

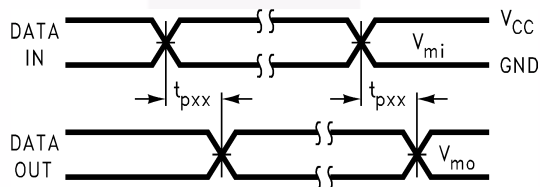
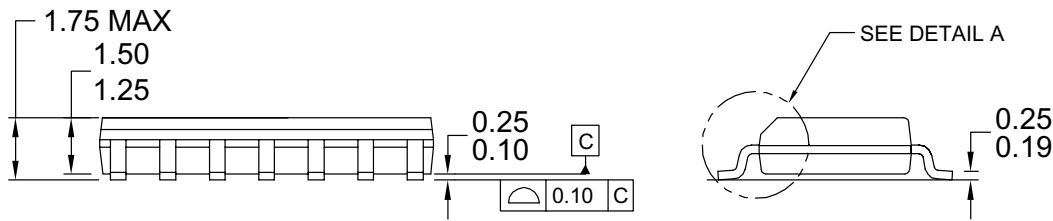
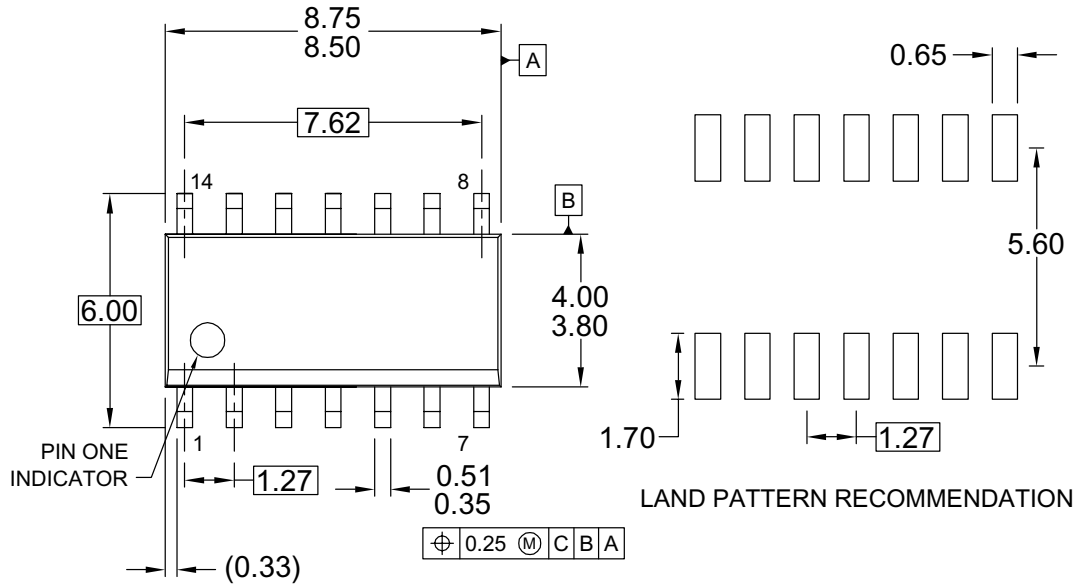
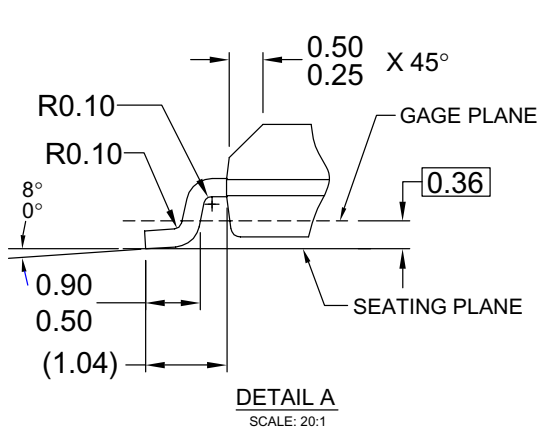

Figure 2. Waveform for Inverting and Non-inverting Functions

Physical Dimensions



NOTES: UNLESS OTHERWISE SPECIFIED



- A) THIS PACKAGE CONFORMS TO JEDEC MS-012, VARIATION AB, ISSUE C,
- B) ALL DIMENSIONS ARE IN MILLIMETERS.
- C) DIMENSIONS DO NOT INCLUDE MOLD FLASH OR BURRS.
- D) LANDPATTERN STANDARD: SOIC127P600X145-14M
- E) DRAWING CONFORMS TO ASME Y14.5M-1994
- F) DRAWING FILE NAME: M14AREV13

Figure 3. 14-Lead Small Outline Integrated Circuit (SOIC), JEDEC MS-012, 0.150" Narrow

Package drawings are provided as a service to customers considering Fairchild components. Drawings may change in any manner without notice. Please note the revision and/or date on the drawing and contact a Fairchild Semiconductor representative to verify or obtain the most recent revision. Package specifications do not expand the terms of Fairchild's worldwide terms and conditions, specifically the warranty therein, which covers Fairchild products.

Always visit Fairchild Semiconductor's online packaging area for the most recent package drawings:

<http://www.fairchildsemi.com/packaging/>

Physical Dimensions (Continued)

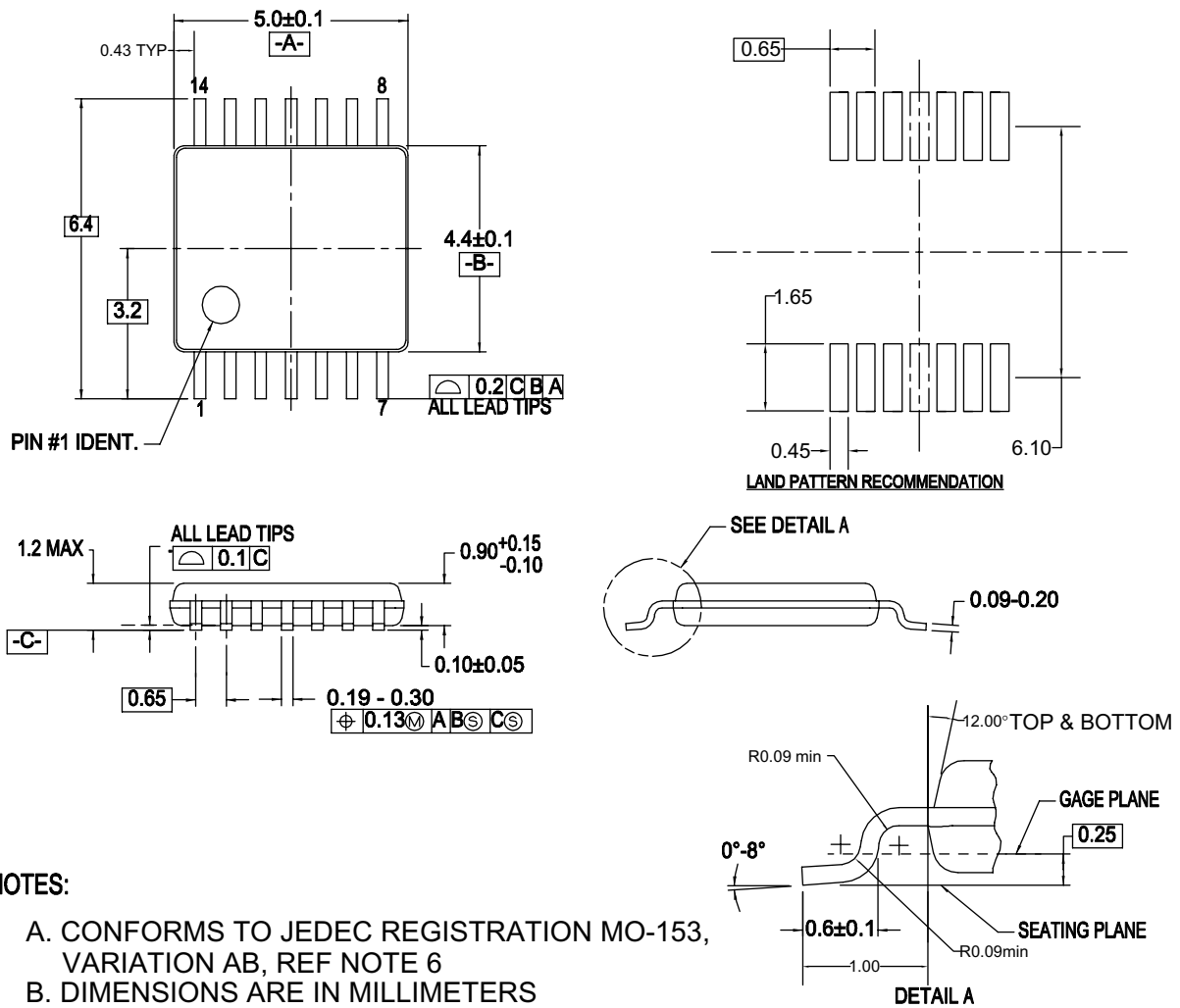

NOTES:

- A. CONFORMS TO JEDEC REGISTRATION MO-153, VARIATION AB, REF NOTE 6
- B. DIMENSIONS ARE IN MILLIMETERS
- C. DIMENSIONS ARE EXCLUSIVE OF BURRS, MOLD FLASH, AND TIE BAR EXTRUSIONS
- D. DIMENSIONING AND TOLERANCES PER ANSI Y14.5M, 1982
- E. LANDPATTERN STANDARD: SOP65P640X110-14M
- F. DRAWING FILE NAME: MTC14REV6

Figure 4. 14-Lead Thin Shrink Small Outline Package (TSSOP), JEDEC MO-153, 4.4mm Wide

Package drawings are provided as a service to customers considering Fairchild components. Drawings may change in any manner without notice. Please note the revision and/or date on the drawing and contact a Fairchild Semiconductor representative to verify or obtain the most recent revision. Package specifications do not expand the terms of Fairchild's worldwide terms and conditions, specifically the warranty therein, which covers Fairchild products.



Always visit Fairchild Semiconductor's online packaging area for the most recent package drawings:

<http://www.fairchildsemi.com/packaging/>



TRADEMARKS

The following includes registered and unregistered trademarks and service marks, owned by Fairchild Semiconductor and/or its global subsidiaries, and is not intended to be an exhaustive list of all such trademarks.

- | | | | |
|---|------------------------|----------------------------|----------------------|
| ACEx® | FPST™ | PDP-SPM™ | SyncFET™ |
| Build it Now™ | FRFET® | Power220® | SYSTEM GENERAL® |
| CorePLUS™ | Global Power Resource™ | Power247® | The Power Franchise® |
| CROSSVOLT™ | Green FPS™ | POWEREDGE® | the power® |
| CTL™ | Green FPS™ e-Series™ | Power-SPM™ | franchise |
| Current Transfer Logic™ | GTO™ | PowerTrench® | TinyBoost™ |
| EcoSPARK® | i-Lo™ | Programmable Active Droop™ | TinyBuck™ |
| EZSWITCH™ * | IntelliMAX™ | QFET® | TinyLogic® |
|  ™ | ISOPLANAR™ | QST™ | TINYOPTO™ |
|  ™ | MegaBuck™ | QT Optoelectronics™ | TinyPower™ |
| Fairchild® | MICROCOUPLER™ | Quiet Series™ | TinyPWM™ |
| Fairchild Semiconductor® | MicroFET™ | RapidConfigure™ | TinyWire™ |
| FACT Quiet Series™ | MicroPak™ | SMART START™ | µSerDes™ |
| FACT® | MillerDrive™ | SPM® | UHC® |
| FAST® | Motion-SPM™ | STEALTH™ | Ultra FRFET™ |
| FastvCore™ | OPTOLOGIC® | SuperFET™ | UniFET™ |
| FlashWriter® * | OPTOPLANAR® | SuperSOT™-3 | VCX™ |
| | | SuperSOT™-6 | |
| | | SuperSOT™-8 | |

* EZSWITCH™ and FlashWriter® are trademarks of System General Corporation, used under license by Fairchild Semiconductor.

DISCLAIMER

FAIRCHILD SEMICONDUCTOR RESERVES THE RIGHT TO MAKE CHANGES WITHOUT FURTHER NOTICE TO ANY PRODUCTS HEREIN TO IMPROVE RELIABILITY, FUNCTION, OR DESIGN. FAIRCHILD DOES NOT ASSUME ANY LIABILITY ARISING OUT OF THE APPLICATION OR USE OF ANY PRODUCT OR CIRCUIT DESCRIBED HEREIN; NEITHER DOES IT CONVEY ANY LICENSE UNDER ITS PATENT RIGHTS, NOR THE RIGHTS OF OTHERS. THESE SPECIFICATIONS DO NOT EXPAND THE TERMS OF FAIRCHILD'S WORLDWIDE TERMS AND CONDITIONS, SPECIFICALLY THE WARRANTY THEREIN, WHICH COVERS THESE PRODUCTS.

LIFE SUPPORT POLICY

FAIRCHILD'S PRODUCTS ARE NOT AUTHORIZED FOR USE AS CRITICAL COMPONENTS IN LIFE SUPPORT DEVICES OR SYSTEMS WITHOUT THE EXPRESS WRITTEN APPROVAL OF FAIRCHILD SEMICONDUCTOR CORPORATION.

As used herein:

- Life support devices or systems are devices or systems which, (a) are intended for surgical implant into the body or (b) support or sustain life, and (c) whose failure to perform when properly used in accordance with instructions for use provided in the labeling, can be reasonably expected to result in a significant injury of the user.
- A critical component in any component of a life support, device, or system whose failure to perform can be reasonably expected to cause the failure of the life support device or system, or to affect its safety or effectiveness.

PRODUCT STATUS DEFINITIONS

Definition of Terms

Datasheet Identification	Product Status	Definition
Advance Information	Formative or In Design	This datasheet contains the design specifications for product development. Specifications may change in any manner without notice.
Preliminary	First Production	This datasheet contains preliminary data; supplementary data will be published at a later date. Fairchild Semiconductor reserves the right to make changes at any time without notice to improve design.
No Identification Needed	Full Production	This datasheet contains final specifications. Fairchild Semiconductor reserves the right to make changes at any time without notice to improve the design.
Obsolete	Not In Production	This datasheet contains specifications on a product that has been discontinued by Fairchild Semiconductor. The datasheet is printed for reference information only.

Rev. I32