

FAN6206

Highly Integrated Dual-Channel Synchronous Rectification Controller for Dual-Forward Converter

Features

- Highly Integrated Dual-Channel SR Controller
- Receives Synchronized Driving Signal from the Primary Side
- Internal Linear-Predict Timing Control for DCM Operation
- Ultra-Low V_{DD} Operating Voltage for Different Output Voltage of PC Power
- V_{DD} Over-Voltage Protection
- 14V Gate Driver Clamp

Applications

- PC Power
- Server Power
- Open-Frame SMPS

Description

The highly integrated FAN6206 is a dual-channel synchronous rectification (SR) controller. FAN6206 allows design of a cost-effective power supply with fewer external components, especially suited for dual-forward topology used to obtain higher efficiency for ATX power supplies.

The primary-side control method provides synchronous rectification control for dual-forward converters that operate in continuous conduction mode (CCM). FAN6206 includes a proprietary linear-predict timing control mechanism for dual-forward converters that operate in discontinuous conduction mode (DCM) at fixed or variable frequency. PWM frequency tracking with secondary-side winding detection is provided by adding dividing resistors. The primary-side signals are generated from Fairchild's FAN6210 (Primary-Side Synchronous Rectifier Signal Trigger for Dual-Forward Converter). The primary-side signals are transferred through a pulse transformer to the secondary-side. The benefits of this technique include simple control method and improved power system reliability.

FAN6206 is available in 8-pin SOP package.

Ordering Information

Part Number	Operating Temperature Range	Package	Packing Method
FAN6206MY	-40°C to +105°C	8-Pin Small Outline Package (SOP)	Tape & Reel

Application Diagram

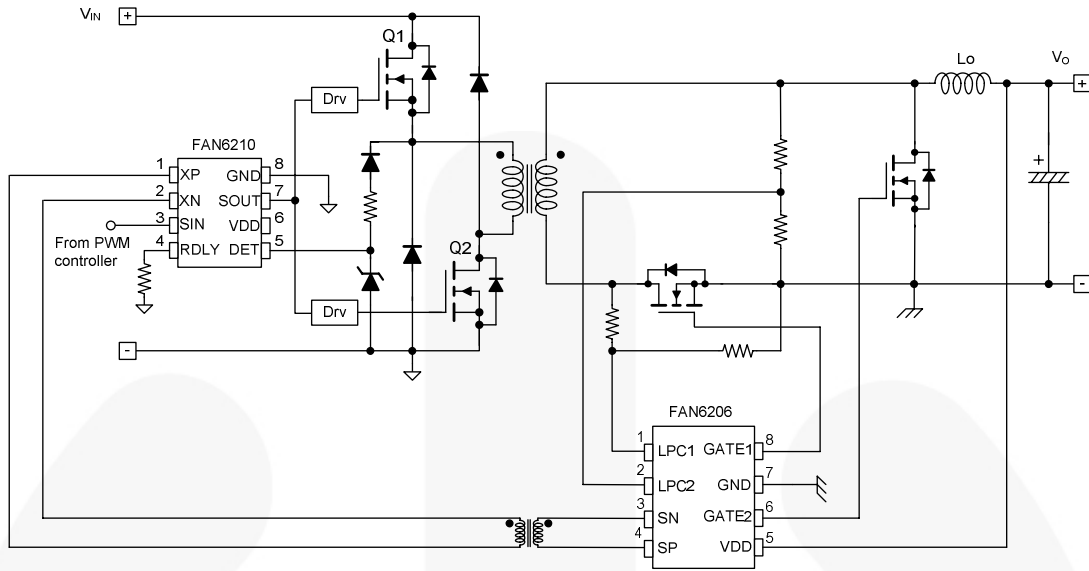

Figure 1. Typical Application

Internal Block Diagram

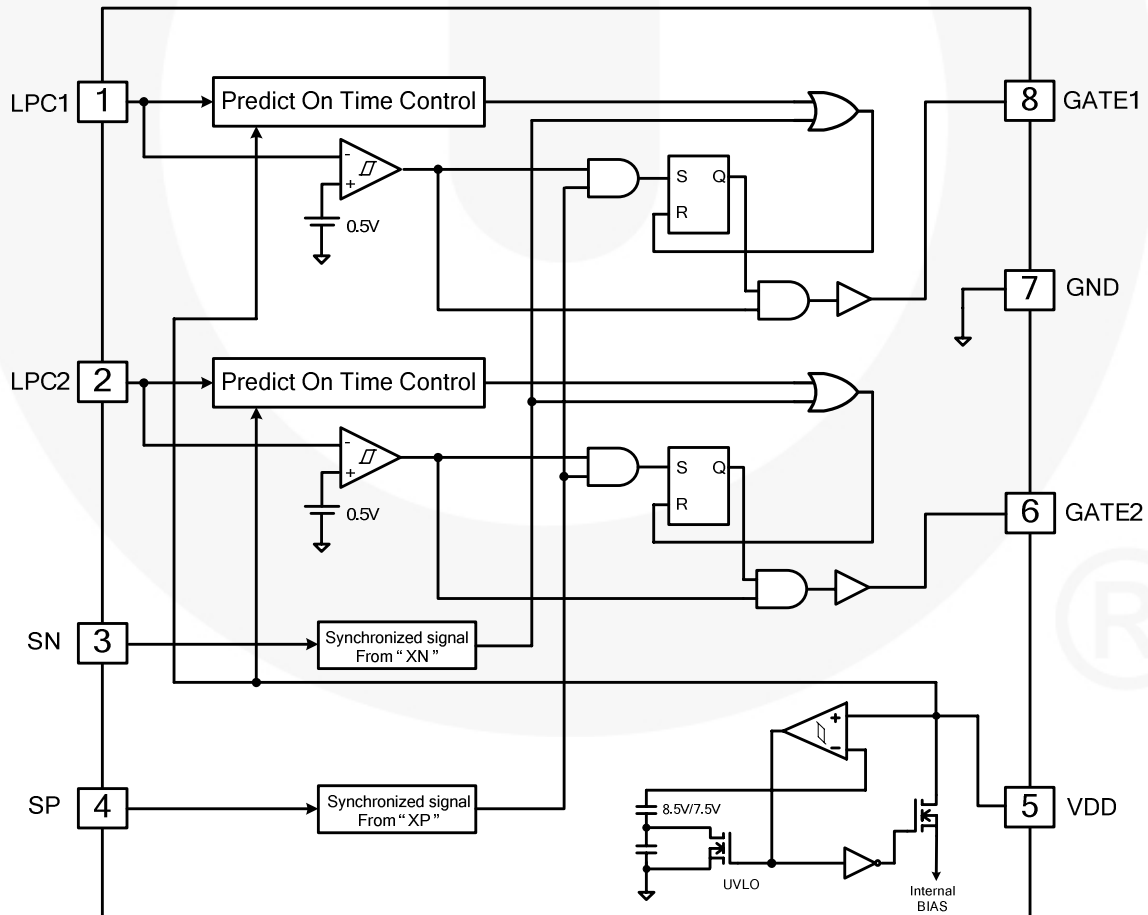
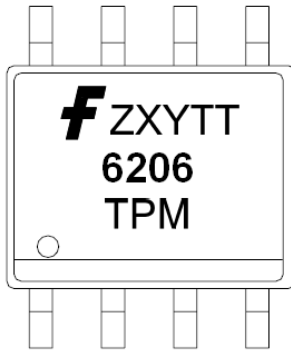

Figure 2. Functional Block Diagram

Marking Information



- F: Fairchild Logo
- Z: Plant Code
- X: Year Code
- Y: Week Code
- TT: Package Type
- T: M=SOP
- P: Y: Green Package
- M: Manufacture Flow Code

Figure 3. Top Mark

Pin Configuration

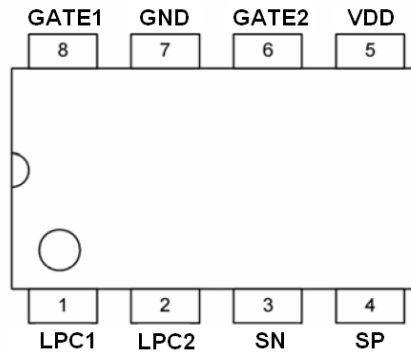

Figure 4. Pin Configuration

Pin Definitions

Pin #	Name	Description
1,2	LPC1, LPC2	Winding detection. This pin is used to detect the voltage on the winding during the on-time period of the primary GATE. An internal current source, I_{CHG} , is determined according to the voltage on the DET pin.
3	SN	Synchronized signal to turn on SR. This pin is used to receive the “XN” signal from the primary side to turn off the SR gate.
4	SP	Synchronized signal to turn on SR. This pin is used to receive the “XP” signal from the primary-side to turn-on the SR gate.
5	VDD	Power supply pin. The threshold voltages for startup and turn-off are 8.5V and 7.5V, respectively.
6	GATE2	Driver output for freewheeling synchronous rectifier MOSFET.
7	GND	Ground
8	GATE1	Driver output for rectifying synchronous rectifier MOSFET.

Absolute Maximum Ratings

Stresses exceeding the absolute maximum ratings may damage the device. The device may not function or be operable above the recommended operating conditions and stressing the parts to these levels is not recommended. In addition, extended exposure to stresses above the recommended operating conditions may affect device reliability. The absolute maximum ratings are stress ratings only.

Symbol	Parameter	Min.	Max.	Unit
V _{DD}	DC Supply Voltage		30	V
V _{HV}	SP, SN		30	V
V _L	LPC	-0.3	7.0	V
P _D	Power Dissipation at T _A < 50°C		400	mW
θ _{JA}	Junction to Ambient Thermal Resistance		130	°C/W
ψ _{Jt}	Junction to Top Thermal Characteristics		46	°C/W
T _J	Operating Junction Temperature	-40	+125	°C
T _{STG}	Storage Temperature Range	-55	+150	°C
T _L	Lead Temperature, (Soldering 10 Seconds)		+260	°C
ESD	Human Body Model, JESD22-A114		4.00	kV
	Charged Device Model, JESD22-C101		1.25	

Notes:

1. Stresses beyond those listed under Absolute Maximum Ratings may cause permanent damage to the device.
2. All voltage values, except differential voltages, are given with respect to GND pin.

Recommended Operating Conditions

The Recommended Operating Conditions table defines the conditions for actual device operation. Recommended operating conditions are specified to ensure optimal performance to the datasheet specifications. Fairchild does not recommend exceeding them or designing to Absolute Maximum Ratings.

Symbol	Parameter	Min.	Max.	Unit
T _A	Operating Ambient Temperature	-40	+105	°C

Electrical Characteristics

$V_{DD}=20V$, $T_A=25^{\circ}C$, unless otherwise specified.

Symbol	Parameter	Conditions	Min.	Typ.	Max.	Units
V_{DD} Section						
V _{OP}	Continuously Operating Voltage				25	V
V _{TH-ON1}	Turn-On Threshold Voltage		8.0	8.5	9.0	V
V _{TH-ON2}	Turn-On Threshold Voltage		8.0	8.5	9.0	V
V _{TH-OFF1}	Turn-Off Threshold Voltage		7.0	7.5	8.0	V
V _{TH-OFF2}	Turn-Off Threshold Voltage		7.0	7.5	8.0	V
I _{DD-OP}	Operating Current	V _{DD} =15V, DET=50KHz		3	5	mA
I _{DD-ST}	Startup Current	V _{DD} = 7.5V		340	500	μA
V _{DD-OVP1}	V _{DD} Over-Voltage Protection 1		20	21	22	V
V _{DD-OVP2}	V _{DD} Over-Voltage Protection 2		20	21	22	V
V _{DD-OVP-HYS1}	Hysteresis Voltage for V _{DD} OVP 1		1.2	1.7	2.2	V
V _{DD-OVP-HYS2}	Hysteresis Voltage for V _{DD} OVP 2		1.2	1.7	2.2	V
t _{OVP1}	V _{DD} OVP Debounce Time 1		40	60	100	μs
t _{OVP2}	V _{DD} OVP Debounce Time 2		40	60	100	μs
Output Drive for SR MOSFET Section						
V _{Z1}	Output Voltage Maximum (Clamp) 1	V _{DD} = 20V		12	14	V
V _{Z2}	Output Voltage Maximum (Clamp) 2	V _{DD} = 20V		12	14	V
V _{OL1}	Output Voltage LOW 1	V _{DD} =12V, I _O =50mA			0.5	V
V _{OL2}	Output Voltage LOW 2	V _{DD} =12V, I _O =50mA			0.5	V
V _{OH1}	Output Voltage HIGH 1	V _{DD} =12V, I _O =50mA	9			V
V _{OH2}	Output Voltage HIGH 2	V _{DD} =12V, I _O =50mA	9			V
t _{R1}	Rising Time 1	V _{DD} =12V, C _L =7nF, OUT=2V~9V	30	70	120	ns
t _{R2}	Rising Time 2	V _{DD} =12V, C _L =7nF, OUT=2V~9V	30	70	120	ns
t _{F1}	Falling Time1	V _{DD} =12V, C _L =7nF, OUT=9V~2V	20	50	100	ns
t _{F2}	Falling Time 2	V _{DD} =12V, C _L =7nF, OUT=9V~2V	20	50	100	ns
V _{Z1}	Output Voltage Maximum (Clamp)	V _{DD} = 20V		12	14	V
t _{PD-HIGH-SP1}	Propagation Delay to OUT HIGH	t _R +t _{PD} , (Trigger by SP), SP-SN =5V	280	350	450	ns
t _{PD-HIGH-SP2}			280	350	450	
t _{PD-LOW-SN1}	Propagation Delay to OUT LOW	t _R +t _{PD} , (Trigger by SN), SP-SN =5V	180	250	350	ns
t _{PD-LOW-SN2}			180	250	350	
t _{PD-LOW-LPC1}	Propagation Delay to OUT LOW	t _R +t _{PD} , (Trigger by LPC)	100	150	200	ns
t _{PD-LOW-LPC2}			100	150	200	
t _{ON-MAX1}	Maximum On Time		12	13	14	μs
t _{ON-MAX2}			12	13	14	μs

Continued on the following page...

Electrical Characteristics

$V_{DD}=20V$, $T_A=25^{\circ}C$, unless otherwise specified.

Symbol	Parameter	Conditions	Min.	Typ.	Max.	Units
SP/SN Section						
$V_{N-P(\text{turn off})1}$	Threshold Voltage of V_N-V_P to Turn-Off SR MOS 1	Sweep V_{N-P} from LOW to HIGH	3	4	5	V
$V_{N-P(\text{turn off})2}$	Threshold Voltage of V_N-V_P to Turn-Off SR MOS 2		3	4	5	V
$V_{P-N(\text{turn on})1}$	Threshold Voltage of V_P-V_N to Turn-On SR MOS 1	Sweep V_{P-N} from LOW to HIGH	3	4	5	V
$V_{P-N(\text{turn on})2}$	Threshold Voltage of V_P-V_N to Turn-On SR MOS 2	Sweep V_{P-N} from LOW to HIGH	3	4	5	V
Ratio_SP-SN	Voltage Difference between SP and SN	$ V_{SP}-V_{SN} / \text{MIN}(V_{SP}, V_{SN})$			5	%
LPC Section						
Ratio_LPC-RES	Charge Divide Discharge Current Transfer Ratio vs. Input Voltage	Connect a Diode 1N4148 and Divider (Ratio 12) to LPC, $V_{DET} = 3V$, $V_{LPC} = 3V$	2.79	3.00	3.21	
$V_{LPC-EN1}$	LPC Enable Threshold Voltage 1		1.8	2.0	2.2	V
$V_{LPC-EN2}$	LPC Enable Threshold Voltage 2		1.8	2.0	2.2	V
$V_{LPC-CLAMP1}$	Lower Clamp Voltage 1	$I_{LPC} = -5\mu A$	0.10	0.25	0.40	V
$V_{LPC-CLAMP2}$	Lower Clamp Voltage 2	$I_{LPC} = -5\mu A$	0.10	0.25	0.40	V
$I_{LPC-SOURCE1}$	Maximum Source Current 1	$V_{LPC} = -0.3V$		250	300	μA
$I_{LPC-SOURCE2}$	Maximum Source Current 2	$V_{LPC} = -0.3V$		250	300	μA
$V_{LPC-LOW1}$	Threshold Voltage for Disable LPC Function		1.3	1.5	1.7	V
$V_{LPC-LOW2}$	Threshold Voltage for Disable LPC Function		1.3	1.5	1.7	V
$t_{LPC-LOW1}$	Debounce Time for Disable LPC Function	$V_{LPC} < V_{LPC-LOW}$	70	100	130	μs
$t_{LPC-LOW2}$	Debounce Time for Disable LPC Function	$V_{LPC} < V_{LPC-LOW}$	70	100	130	μs

Typical Performance Characteristics

These characteristic graphs are normalized at $T_A = 25^\circ\text{C}$.

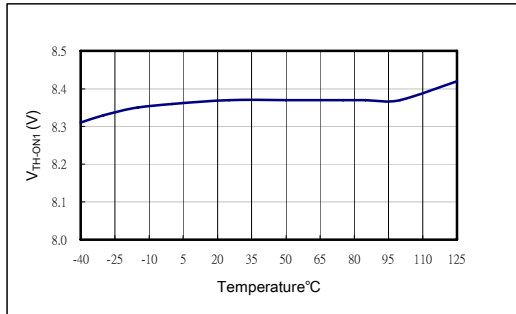

Figure 5. Turn-On Threshold Voltage 1

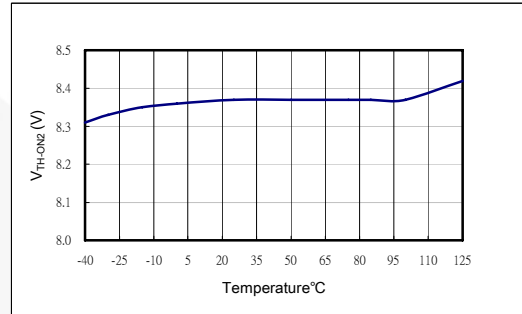

Figure 6. Turn-On Threshold Voltage 2

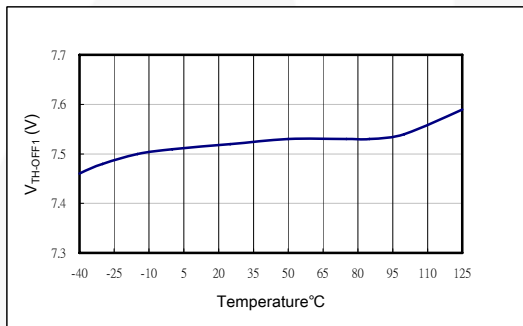

Figure 7. Turn-Off Threshold Voltage 1

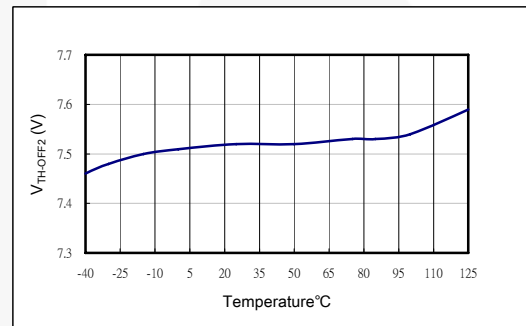

Figure 8. Turn-Off Threshold Voltage 2

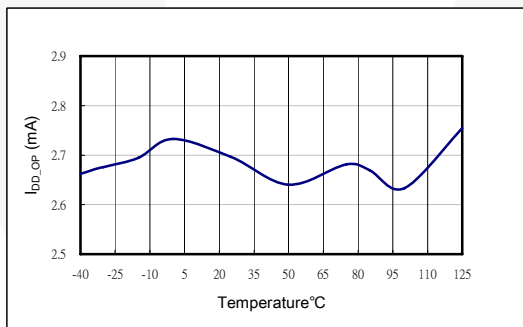

Figure 9. Operating Current

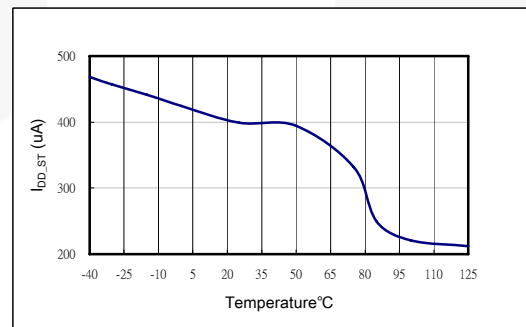

Figure 10. Startup Current

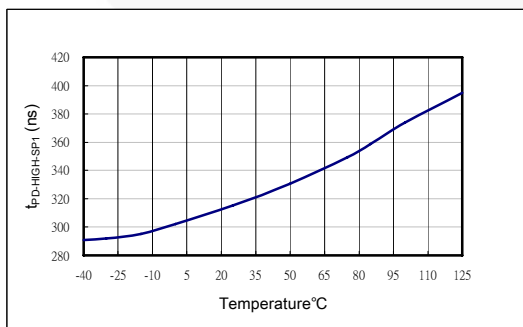

Figure 11. Propagation Delay to OUT HIGH 1 (Trigger by SP)

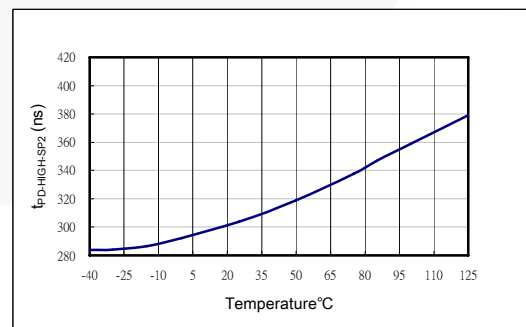

Figure 12. Propagation Delay to OUT HIGH 2 (Trigger by SP)

Typical Performance Characteristics

These characteristic graphs are normalized at $T_A = 25^\circ\text{C}$.

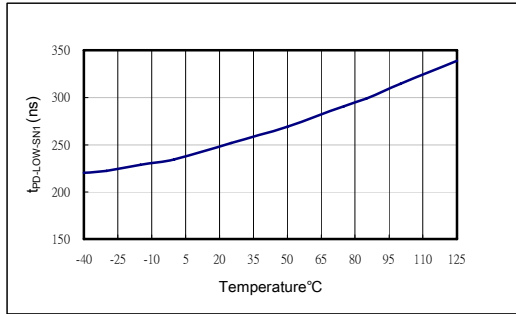

Figure 13. Propagation Delay to OUT LOW 1 (Trigger by SN)

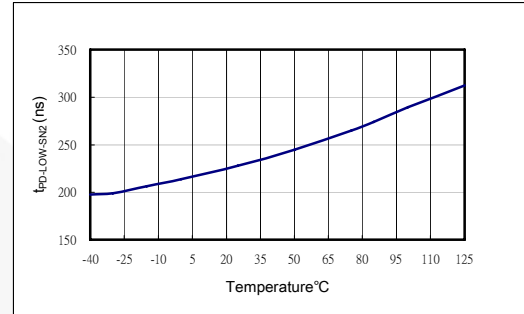

Figure 14. Propagation Delay to OUT LOW 2 (Trigger by SN)

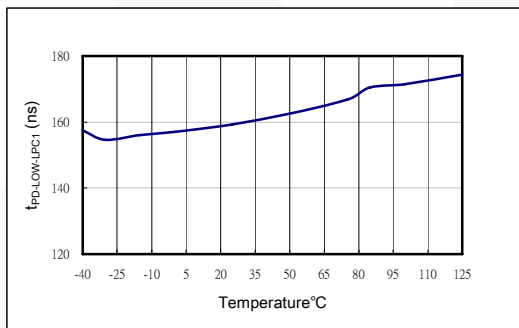

Figure 15. Propagation Delay to OUT LOW 1 (Trigger by LPC)

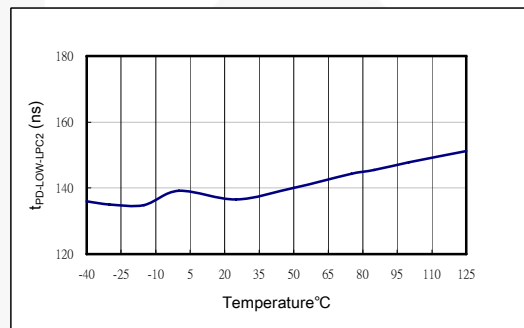

Figure 16. Propagation Delay to OUT LOW 2 (Trigger by LPC)

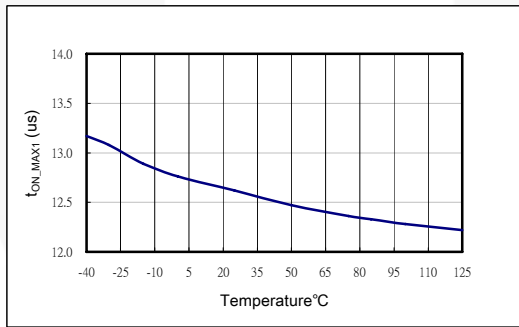

Figure 17. Maximum On Time 1

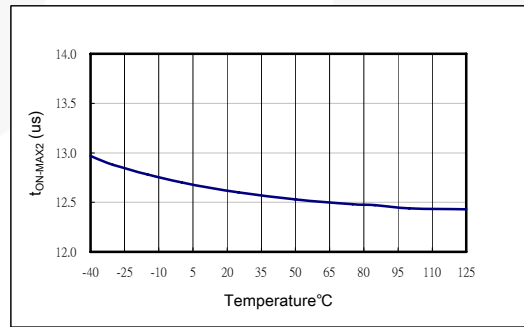

Figure 18. Maximum On Time 2

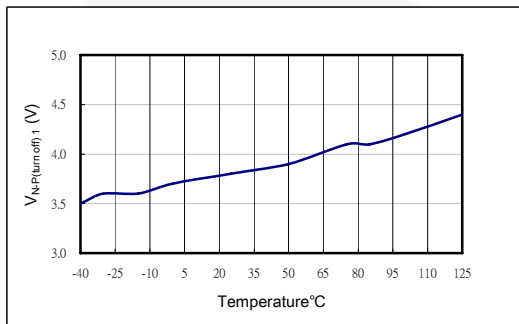

Figure 19. Threshold Voltage of V_N-V_P to Turn Off SR MOS 1

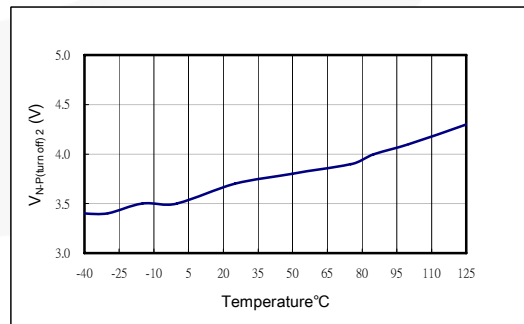

Figure 20. Threshold Voltage of V_N-V_P to Turn Off SR MOS 2

Typical Performance Characteristics

These characteristic graphs are normalized at $T_A = 25^\circ\text{C}$.

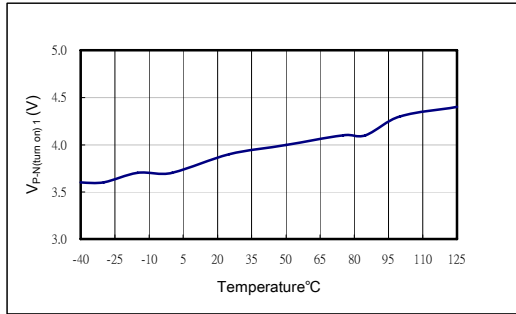

Figure 21. Threshold Voltage of VP-VN to Turn On SR MOS 1

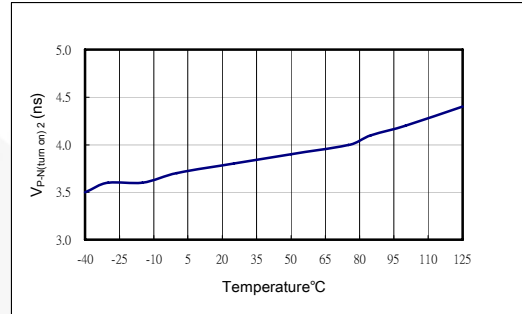

Figure 22. Threshold Voltage of VP-VN to Turn On SR MOS 2

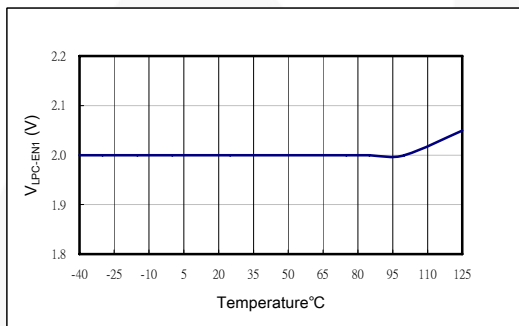

Figure 23. LPC Enable Threshold Voltage 1

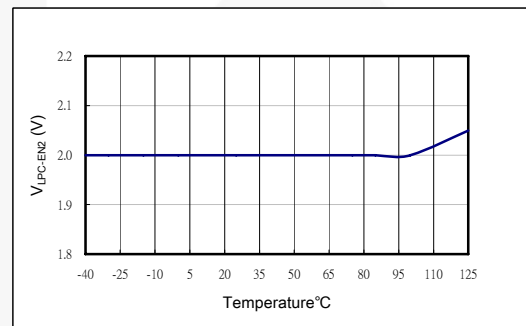

Figure 24. LPC Enable Threshold Voltage 2

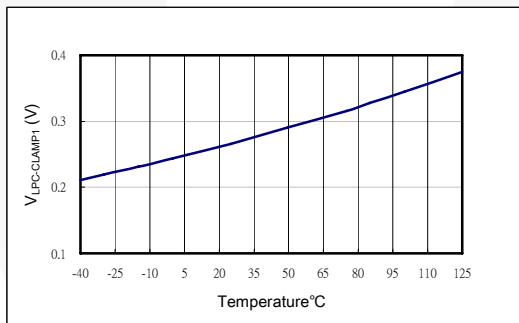

Figure 25. Lower Clamp Voltage 1

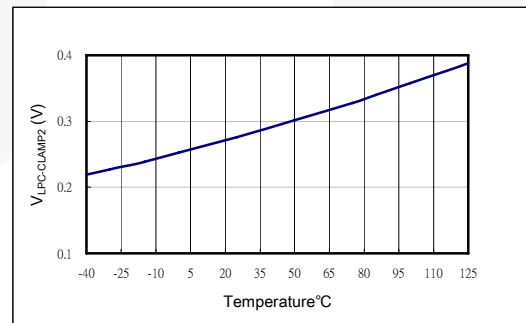

Figure 26. Lower Clamp Voltage 2

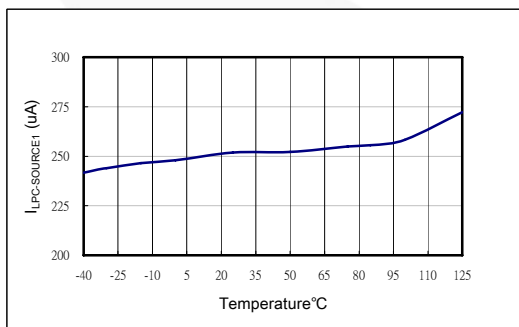

Figure 27. Maximum Source Current 1

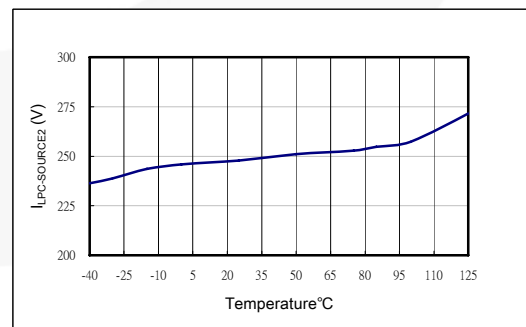

Figure 28. Maximum Source Current 2

Function Description

Figure 29 and Figure 30 show the simplified circuit diagram of a dual-forward converter and its key waveforms. Switches Q_1 and Q_2 are turned on and off together. Once Q_1 and Q_2 are turned on, input voltage is applied across the transformer primary side and power is delivered to the secondary side through the transformer, powering D_1 . During this time, the magnetizing current linearly increases. When Q_1 and Q_2 are turned off, the magnetizing current of the transformer forces the reset diodes (D_{R1} and D_{R2}) and negative input voltage is applied across the transformer primary side. During this time, magnetizing current linearly decreases to zero and the secondary-side inductor current freewheels through diode D_2 . When synchronous rectifier SR_1 and SR_2 are used instead of diodes D_1 and D_2 , it is important to have proper timing between drive signals for SR_1 and SR_2 .

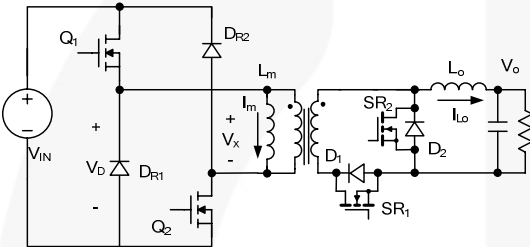

Figure 29. Simplified Circuit Diagram of Dual-Forward Converter

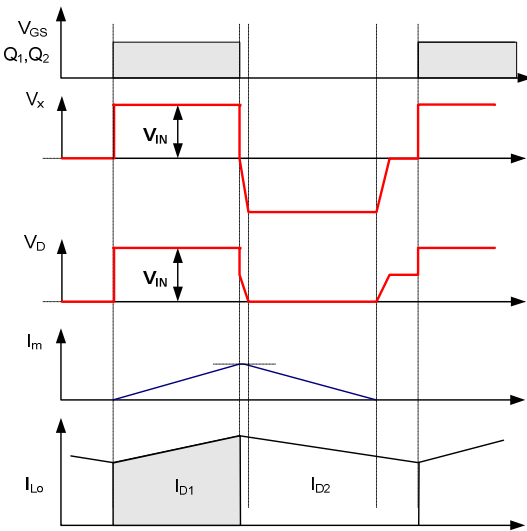

Figure 30. Key Waveforms of Dual-Forward Converter

Figure 31 shows a typical application circuit. When a dual-forward converter operates in continuous conduction mode, the SR signals (GATE1 and GATE2) are mainly controlled by SP and SN signals. SP and SN signals are transferred through a pulse transformer from XP and XN signals, which are generated by FAN6210 (Primary-Side Synchronous Rectifier Signal Trigger for Dual Forward Converter).

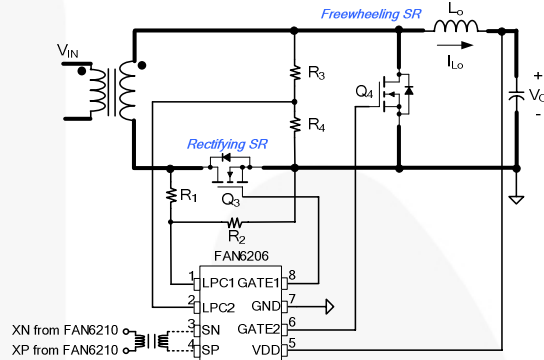

Figure 31. Typical Application Circuit

Figure 32 shows the timing diagram for continuous conduction mode (CCM). Figure 33 shows the timing diagram for discontinuous conduction mode (DCM).

The switching operation of SR MOSFETs Q_3 and Q_4 is determined by the SN and SP signals. FAN6206 turns on SR MOSFETs at the rising edge of the SP signal, while it turns off the SR MOSFETs at the rising edge of the SN signal. Within one switching cycle, SP and SN are obtained two times.

With a voltage divider R_1 and R_2 connected from LPC1 to secondary winding, R_3 and R_4 connected from LPC2 to secondary winding, the PWM timing sequences and frequency can be tracked precisely. The SR MOSFET is turned on by SP signal only when the voltage level on LPC1 or LPC2 pin is pulled LOW to GND.

During PWM-on period, the rectifying SR Q_3 is turned on by the rising edge of the SP signal after a propagation delay ($t_{PD-HIGH-SP1}$) and Q_3 is turned off by the rising edge of the SN signal after a propagation delay ($t_{PD-LOW-SN1}$). During PWM-off period, the freewheeling SR Q_4 is turned on by the rising edge of the SP signal after a propagation delay ($t_{PD-HIGH-SP2}$) and Q_4 is turned off by the rising edge of the SN signal after a propagation delay ($t_{PD-LOW-SN2}$) in CCM operation.

In DCM operation, the proprietary Linear-Predict Timing Control (LPC) technique can provide synchronous rectification control mechanism for freewheeling SR MOSFET. Since SN signal is sent following with PWM signal, the freewheeling SR MOSFET cannot be turned off in time by SN signal before I_{L_o} linearly decreases to zero. Therefore, the LPC mechanism is applied to turn off Q_3 in DCM mode.

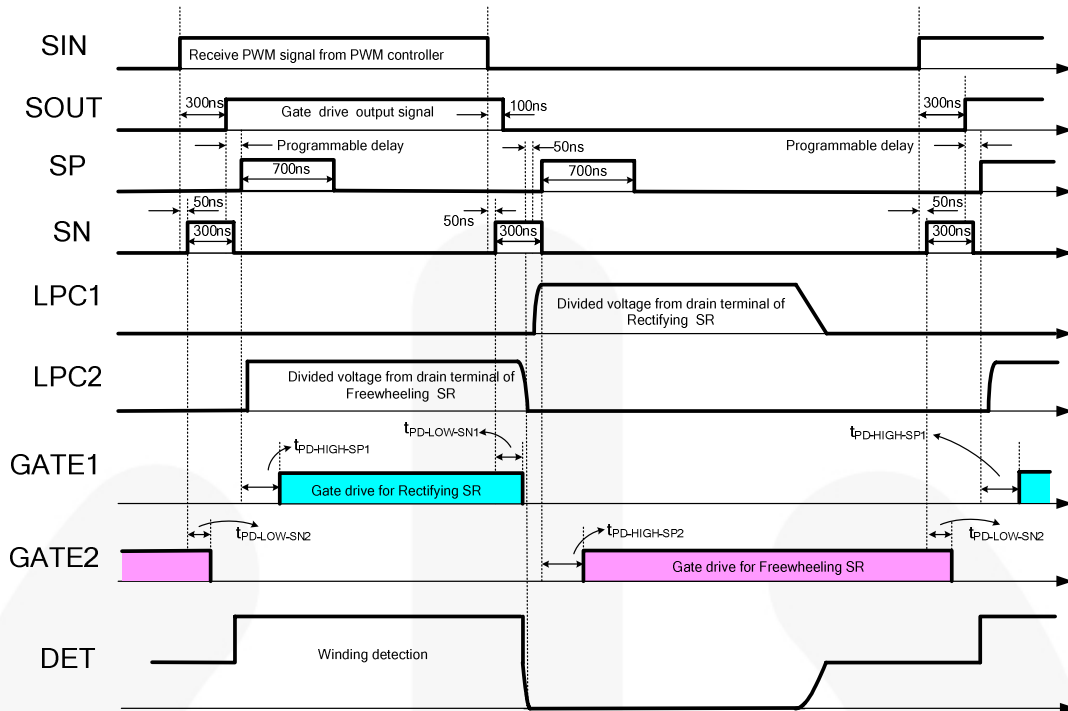

Figure 32. SR Gate is Driven by SP & SN Signal in CCM Mode

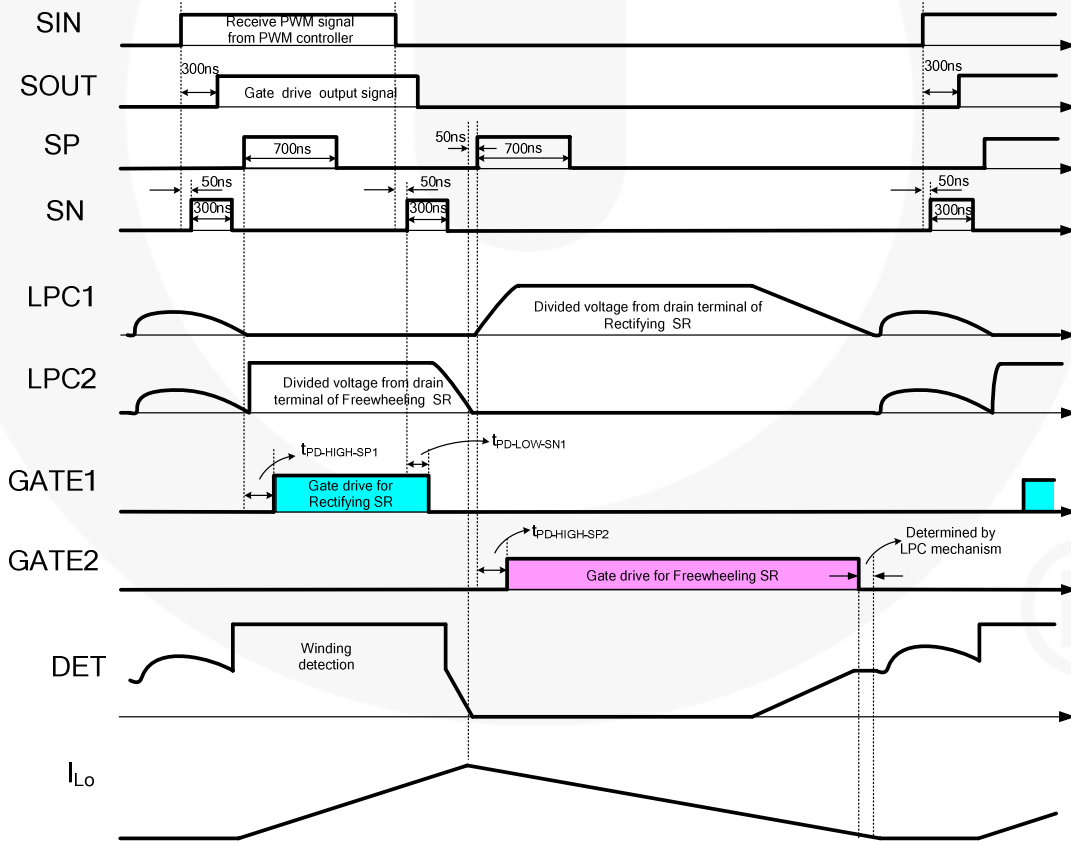

Figure 33. Freewheeling SR Turned Off by LPC Mechanism in DCM Mode

Linear-Predict Timing Control

When a dual-forward converter operates in CCM or DCM; in PWM t_{ON} period, the V_{IN} voltage is applied to the primary winding and the secondary inductor starts to rise linearly and store energy. The across voltage on secondary winding is coupled from primary winding and proportional to V_{IN} . The SR controller can detect this winding voltage through a voltage divider and acquire the V_{IN} level. According to this detected V_{IN} level during PWM turn-on period, SR controller produces a charge current I_{CHG} to charge internal capacitor, CT, of the SR controller. On the other hand, at PWM turn-off period, the energy stored in the secondary inductor is discharged. The SR controller also detects the output voltage level to modulate discharge current I_{DISCHG} of internal capacitor, CT. Once the internal capacitor voltage reaches zero, SR controller turns off SR MOS immediately.

R_4 is connected between the LPC2 pin and the drain terminal of Q_4 . During PWM turn-on period, voltage on the LPC2 pin is pulled HIGH due to the secondary winding coupled from primary winding. At this moment, SR MOS is turned off and the internal body diode of SR MOS is reverse-biased. During PWM turn-off period, the potential on the primary winding reverses and the internal body diode starts to conduct output current. The voltage on the LPC2 pin is also pulled LOW to GND. R_2 is recommended as $10k\Omega$ and the divided voltage level on the LPC1 pin is suggested between $3V\sim 5V$. If the voltage level of V_O is $12V$, the resistor values are recommended as $105k\Omega$ for R_3 and $10k\Omega$ for R_4 . The turn-off timing of Q_4 is determined by the ratio $\frac{R_4}{R_3 + R_4}$

as Figure 34 shows. If $\frac{R_4}{R_3 + R_4}$ decreases, Q_4 is turned off earlier.

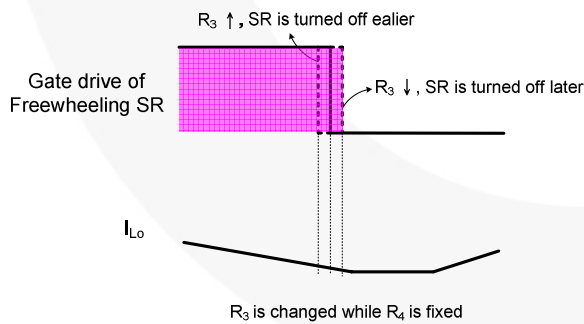

Figure 34. Turn-Off Timing of Freewheeling SR

Under-Voltage Lockout (UVLO)

The power-on and off thresholds are fixed at $8.5V$ and $7.5V$. The VDD pin is connected to a $12V$ output voltage terminal.

VDD Pin Over-Voltage Protection

The over-voltage conditions are usually caused by open feedback loops. V_{DD} over-voltage protection is built in to prevent damage if over voltage occurs. When the voltage on the VDD pin exceeds $21V$, the SR controller turns off all of SR MOS operations.

Typical Application Circuit (Dual-Forward Converter with SR)

Application	Fairchild Devices	Input Voltage Range	Output
PC Power	FAN4801 FAN6210 FAN6206	90~264V _{AC}	12V/25A

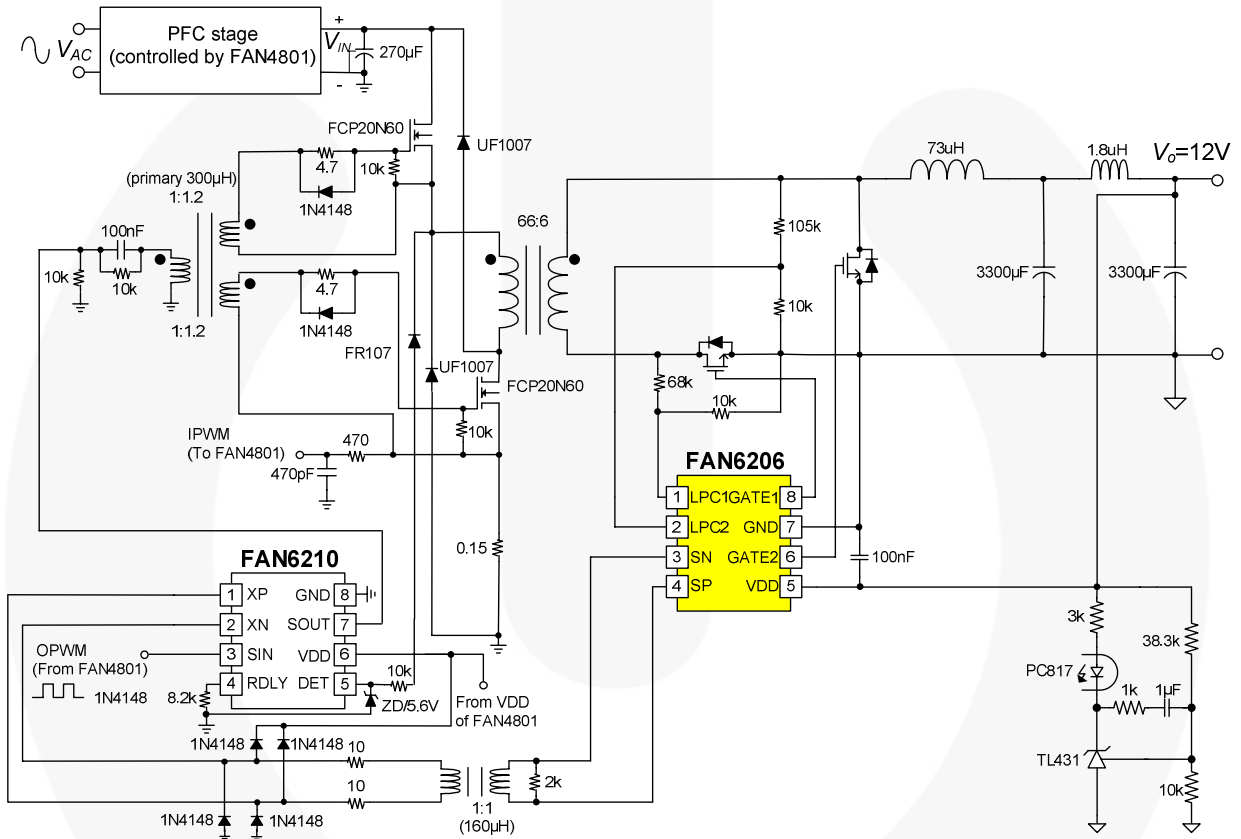

Figure 35. Application Circuit

Physical Dimensions

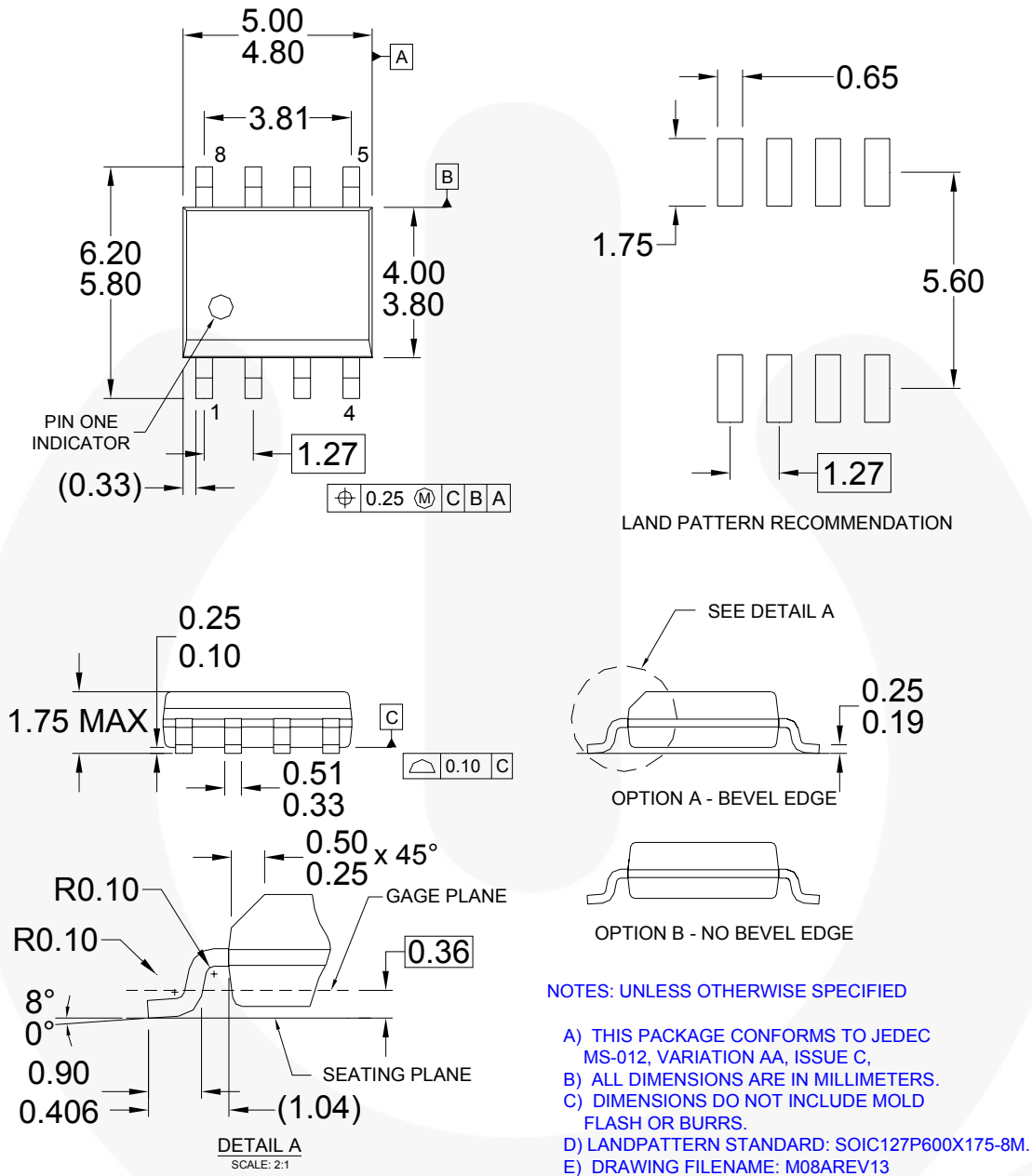

Figure 36. 8-Pin Small Outline Package (SOP)

Package drawings are provided as a service to customers considering Fairchild components. Drawings may change in any manner without notice. Please note the revision and/or date on the drawing and contact a Fairchild Semiconductor representative to verify or obtain the most recent revision. Package specifications do not expand the terms of Fairchild's worldwide terms and conditions, specifically the warranty therein, which covers Fairchild products.

Always visit Fairchild Semiconductor's online packaging area for the most recent package drawings:
<http://www.fairchildsemi.com/packaging/>



TRADEMARKS

The following includes registered and unregistered trademarks and service marks, owned by Fairchild Semiconductor and/or its global subsidiaries, and is not intended to be an exhaustive list of all such trademarks.

AccuPower™
 Auto-SPM™
 Build it Now™
 CorePLUS™
 CorePOWER™
 CROSSVOL7™
 CTL™
 Current Transfer Logic™
 DEUXPEED®
 Dual Cool™
 EcoSPARK®
 EfficientMax™
 ESBC™
 F®
 Fairchild®
 Fairchild Semiconductor®
 FACT Quiet Series™
 FACT®
 FAST®
 FastvCore™
 FETBench™
 FlashWriter®
 FPS™

F-PFS™
 FRFET®
 Global Power Resource™
 Green FPS™
 Green FPS™ e-Series™
 Gmax™
 GTO™
 IntelliMAX™
 ISOPLANAR™
 MegaBuck™
 MICROCOUPLER™
 MicroFET™
 MicroPak™
 MicroPak2™
 MillerDrive™
 MotionMax™
 Motion-SPM™
 OptoHIT™
 OPTOLOGIC®
 OPTOPLANAR®
 PDP SPM™

Power-SPM™
 PowerTrench®
 PowerXS™
 Programmable Active Droop™
 QFET®
 QS™
 Quiet Series™
 RapidConfigure™

 Saving our world, 1mW/w/kW at a time™
 SignalWise™
 SmartMax™
 SMART START™
 SPM®
 STEALTH™
 SuperFET™
 SuperSOT™-3
 SuperSOT™-6
 SuperSOT™-8
 SupreMOS™
 SyncFET™
 Sync-Lock™

 SYSTEM GENERAL®
 The Power Franchise®
 power franchise
 TinyBoost™
 TinyBuck™
 TinyCalc™
 TinyLogic®
 TINYOPTO™
 TinyPower™
 TinyPWM™
 TinyWire™
 TriFault Detect™
 TRUECURRENT™*
 μSerDes™
 SerDes™
 UHC®
 Ultra FRFET™
 UniFET™
 VCX™
 VisualMax™
 XST™

* Trademarks of System General Corporation, used under license by Fairchild Semiconductor.

DISCLAIMER

FAIRCHILD SEMICONDUCTOR RESERVES THE RIGHT TO MAKE CHANGES WITHOUT FURTHER NOTICE TO ANY PRODUCTS HEREIN TO IMPROVE RELIABILITY, FUNCTION, OR DESIGN. FAIRCHILD DOES NOT ASSUME ANY LIABILITY ARISING OUT OF THE APPLICATION OR USE OF ANY PRODUCT OR CIRCUIT DESCRIBED HEREIN; NEITHER DOES IT CONVEY ANY LICENSE UNDER ITS PATENT RIGHTS, NOR THE RIGHTS OF OTHERS. THESE SPECIFICATIONS DO NOT EXPAND THE TERMS OF FAIRCHILD'S WORLDWIDE TERMS AND CONDITIONS, SPECIFICALLY THE WARRANTY THEREIN, WHICH COVERS THESE PRODUCTS.

LIFE SUPPORT POLICY

FAIRCHILD'S PRODUCTS ARE NOT AUTHORIZED FOR USE AS CRITICAL COMPONENTS IN LIFE SUPPORT DEVICES OR SYSTEMS WITHOUT THE EXPRESS WRITTEN APPROVAL OF FAIRCHILD SEMICONDUCTOR CORPORATION.

As used herein:

1. Life support devices or systems are devices or systems which, (a) are intended for surgical implant into the body or (b) support or sustain life, and (c) whose failure to perform when properly used in accordance with instructions for use provided in the labeling, can be reasonably expected to result in a significant injury of the user.
2. A critical component in any component of a life support, device, or system whose failure to perform can be reasonably expected to cause the failure of the life support device or system, or to affect its safety or effectiveness.

ANTI-COUNTERFEITING POLICY

Fairchild Semiconductor Corporation's Anti-Counterfeiting Policy. Fairchild's Anti-Counterfeiting Policy is also stated on our external website, www.fairchildsemi.com, under Sales Support.

Counterfeiting of semiconductor parts is a growing problem in the industry. All manufacturers of semiconductor products are experiencing counterfeiting of their parts. Customers who inadvertently purchase counterfeit parts experience many problems such as loss of brand reputation, substandard performance, failed applications, and increased cost of production and manufacturing delays. Fairchild is taking strong measures to protect ourselves and our customers from the proliferation of counterfeit parts. Fairchild strongly encourages customers to purchase Fairchild parts either directly from Fairchild or from Authorized Fairchild Distributors who are listed by country on our web page cited above. Products customers buy either from Fairchild directly or from Authorized Fairchild Distributors are genuine parts, have full traceability, meet Fairchild's quality standards for handling and storage and provide access to Fairchild's full range of up-to-date technical and product information. Fairchild and our Authorized Distributors will stand behind all warranties and will appropriately address any warranty issues that may arise. Fairchild will not provide any warranty coverage or other assistance for parts bought from Unauthorized Sources. Fairchild is committed to combat this global problem and encourage our customers to do their part in stopping this practice by buying direct or from authorized distributors.

PRODUCT STATUS DEFINITIONS

Definition of Terms

Datasheet Identification	Product Status	Definition
Advance Information	Formative / In Design	Datasheet contains the design specifications for product development. Specifications may change in any manner without notice.
Preliminary	First Production	Datasheet contains preliminary data; supplementary data will be published at a later date. Fairchild Semiconductor reserves the right to make changes at any time without notice to improve design.
No Identification Needed	Full Production	Datasheet contains final specifications. Fairchild Semiconductor reserves the right to make changes at any time without notice to improve the design.
Obsolete	Not In Production	Datasheet contains specifications on a product that is discontinued by Fairchild Semiconductor. The datasheet is for reference information only.

Rev. 148