

# GP1S74PJ000F

Gap : 5mm Slit : 0.5mm  
Phototransistor Output,  
Snap-in fixing  
Transmissive Photointerrupter with  
Connector



## ■ Description

**GP1S74PJ000F** is a standard, phototransistor output, transmissive photointerrupter with opposing emitter and detector in a case, providing non-contact sensing. For this family of devices, the emitter and detector are inserted in a case, and a 3-pin connector is included to allow remote-mount or off-board designs.

## ■ Features

1. Transmissive with phototransistor output
2. Highlights :
  - Special position hooks compatible with 3 different plate thicknesses (1.0, 1.2, 1.6mm)
  - Snap insertion
3. Key Parameters :
  - Gap Width : 5mm
  - Slit Width (detector side): 0.5mm
  - Package : 17×12.8×8mm (without connector and hooks)
  - Connector : Tyco Electronics AMP K.K. (PN : 292133-3)
4. Lead free and RoHS directive compliant

## ■ Agency approvals/Compliance

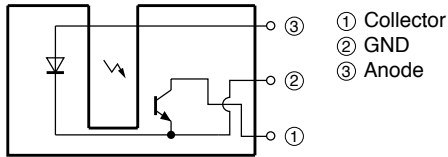
1. Compliant with RoHS directive

## ■ Applications

1. General purpose detection of object presence or motion.
2. Example : PPC, FAX, Printer

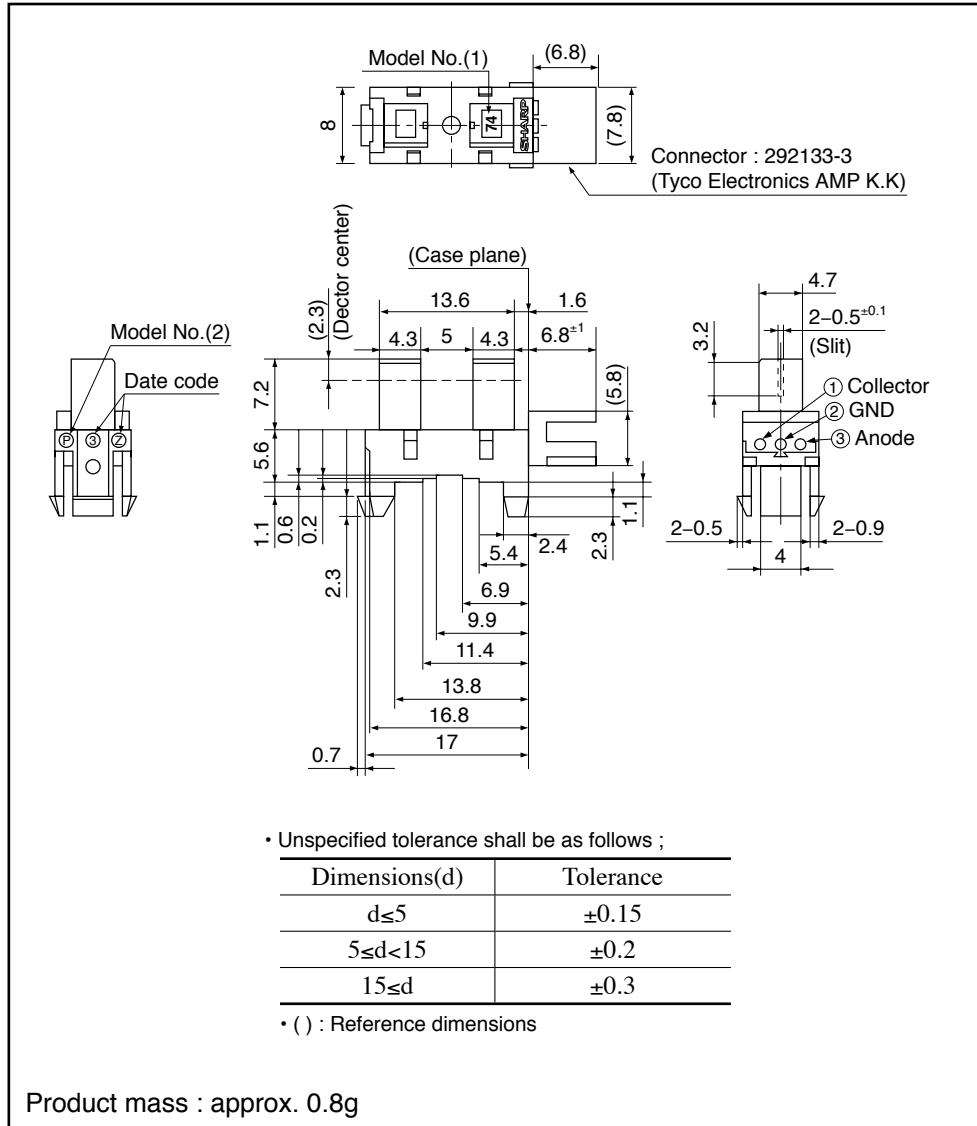
Notice The content of data sheet is subject to change without prior notice.  
In the absence of confirmation by device specification sheets, SHARP takes no responsibility for any defects that may occur in equipment using any SHARP devices shown in catalogs, data books, etc. Contact SHARP in order to obtain the latest device specification sheets before using any SHARP device.

## Internal Connection Diagram



## Outline Dimensions

(Unit : mm)



Connector terminal plating material : Sn

**Date code (2 digit)**

1st digit		2nd digit	
Year of production		Month of production	
A.D.	Mark	Month	Mark
2000	0	1	1
2001	1	2	2
2002	2	3	3
2003	3	4	4
2004	4	5	5
2005	5	6	6
2006	6	7	7
2007	7	8	8
2008	8	9	9
2009	9	10	X
2010	0	11	Y
:	:	12	Z

repeats in a 10 year cycle

**Country of origin**

Japan or Philippines

(Indicated on the packing case)

## ■ Absolute Maximum Ratings (T<sub>a</sub>=25°C)

Parameter		Symbol	Rating	Unit
Input	*1 Forward current	I <sub>F</sub>	50	mA
	*1, 2 Peak forward current	I <sub>FM</sub>	1	A
	Reverse voltage	V <sub>R</sub>	6	V
	Power dissipation	P	75	mW
Output	Collector-emitter voltage	V <sub>CEO</sub>	35	V
	Emitter-collector voltage	V <sub>ECO</sub>	6	V
	Collector current	I <sub>C</sub>	20	mA
	*1 Collector power dissipation	P <sub>C</sub>	75	mW
*3 Operating temperature		T <sub>opr</sub>	-25 to +85	°C
*3 Storage temperature		T <sub>stg</sub>	-40 to +85	°C

\*1 Refer to Fig. 1, 2, 3

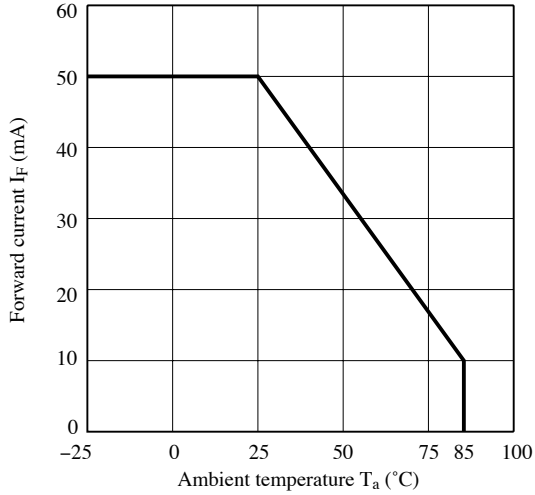
\*2 Pulse width ≤ 100μs, Duty ratio=0.01

\*3 The connector should be plugged in/out at normal temperature.

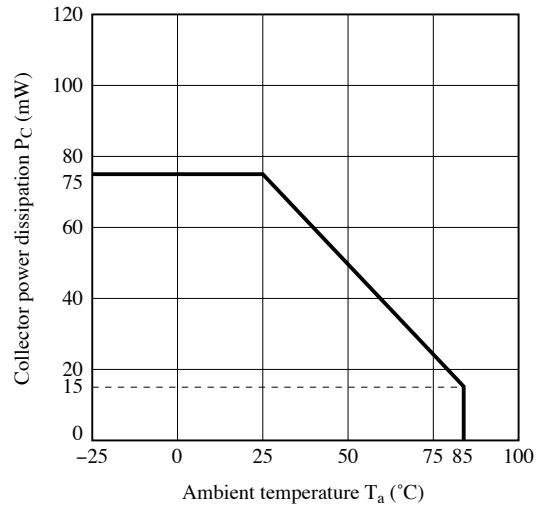
## ■ Electro-optical Characteristics (T<sub>a</sub>=25°C)

Parameter		Symbol	Condition	MIN.	TYP.	MAX.	Unit
Input	Forward voltage	V <sub>F</sub>	I <sub>F</sub> =20mA	-	1.2	1.4	V
	Peak forward voltage	V <sub>FM</sub>	I <sub>FM</sub> =0.5A	-	3	4	V
	Reverse current	I <sub>R</sub>	V <sub>R</sub> =3V	-	-	10	μA
Output	Collector dark current	I <sub>CEO</sub>	V <sub>CE</sub> =20V	-	1	100	nA
Transfer characteristics	Collector current	I <sub>C</sub>	V <sub>CE</sub> =5V, I <sub>F</sub> =20mA	0.5	-	15	mA
	Collector-emitter saturation voltage	V <sub>CE(sat)</sub>	I <sub>F</sub> =40mA, I <sub>C</sub> =0.5mA	-	-	0.4	V
	Response time	Rise time	t <sub>r</sub>	V <sub>CE</sub> =2V, I <sub>C</sub> =2mA, R <sub>L</sub> =100Ω	-	3	15
Fall time		t <sub>f</sub>	-		4	20	

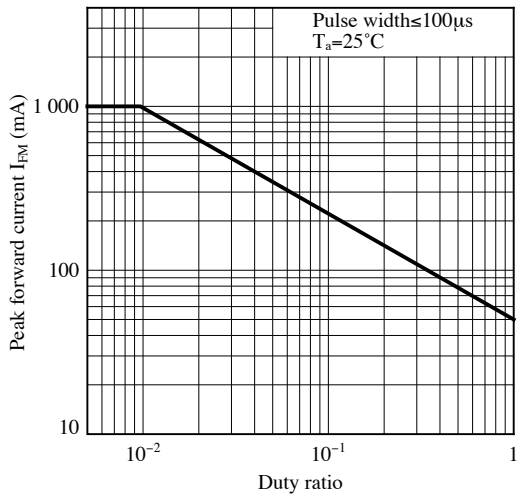
**Fig.1 Forward Current vs. Ambient Temperature**



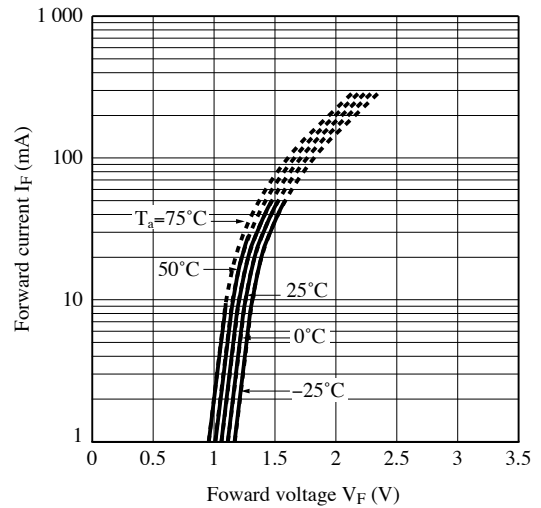
**Fig.2 Collector Power Dissipation vs. Ambient Temperature**



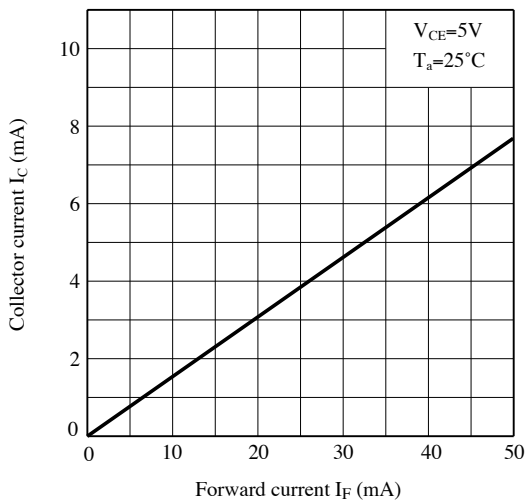
**Fig.3 Peak Forward Current vs. Duty Ratio**



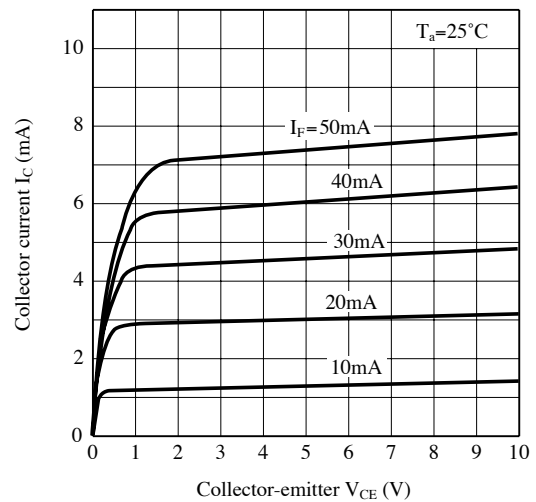
**Fig.4 Forward Current vs. Forward Voltage**



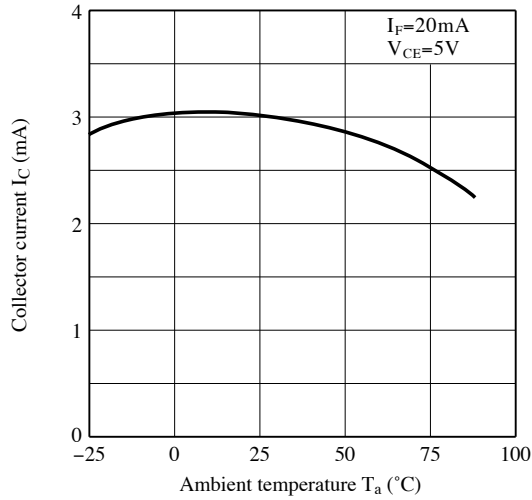
**Fig.5 Collector Current vs. Forward Current**



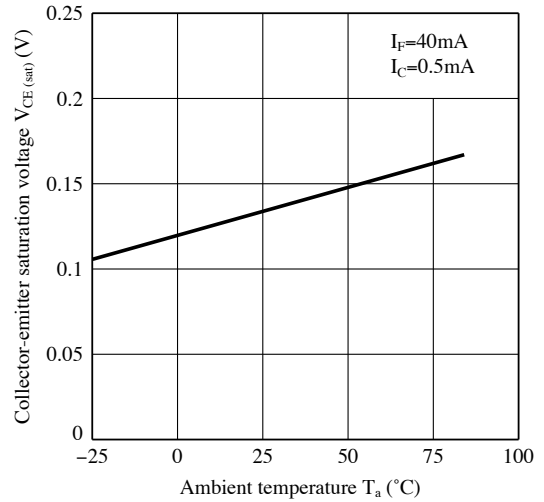
**Fig.6 Collector Current vs. Collector-emitter Voltage**



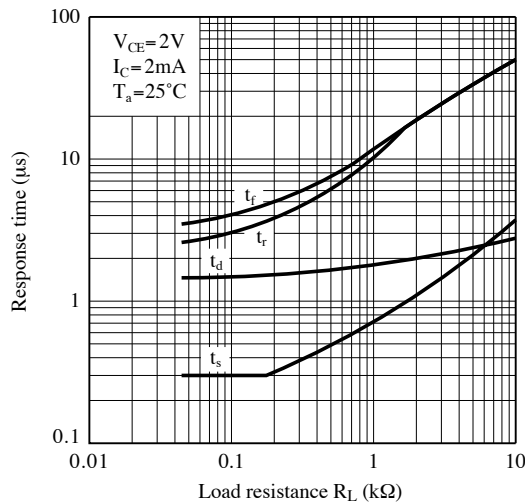
**Fig.7 Collector Current vs. Ambient Temperature**



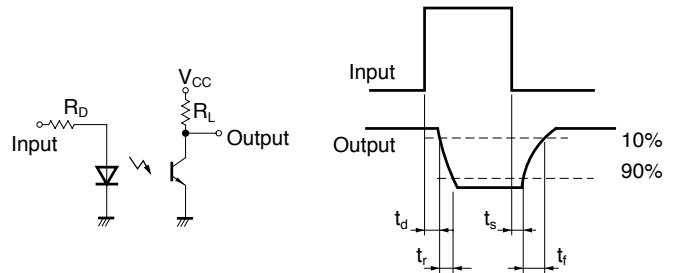
**Fig.8 Collector-emitter Saturation Voltage vs. Ambient Temperature**



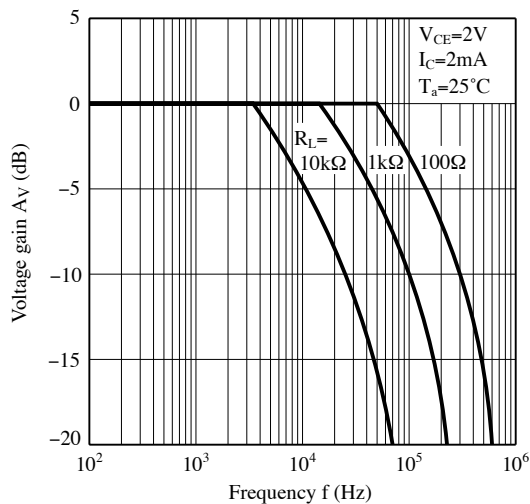
**Fig.9 Response Time vs. Load Resistance**



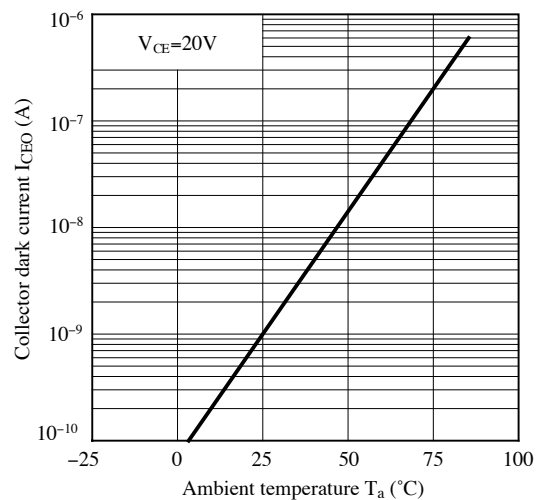
**Fig.10 Test Circuit for Response Time**



**Fig.11 Frequency Response**

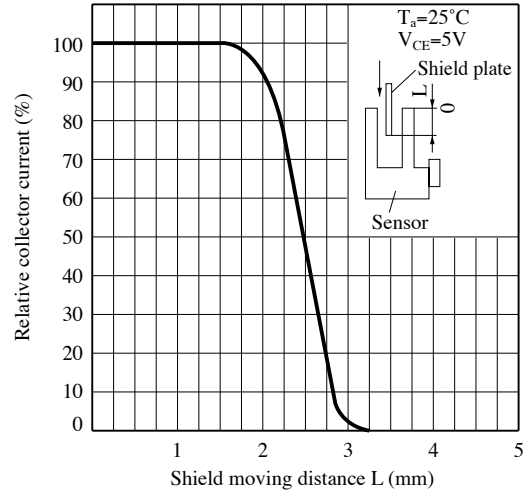
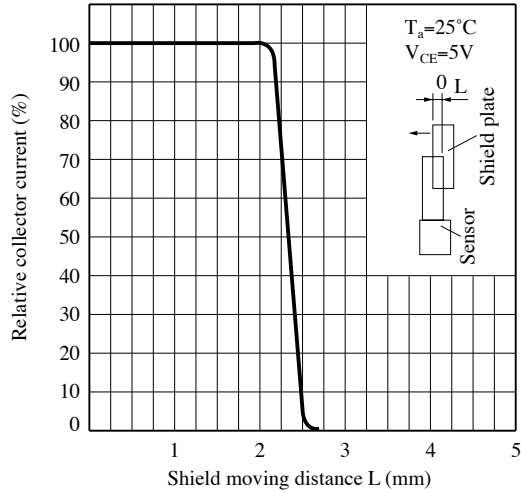


**Fig.12 Collector Dark Current vs. Ambient Temperature**



**Fig.13 Detecting Position Characteristics (1)**

**Fig.14 Detecting Position Characteristics (2)**



Remarks : Please be aware that all data in the graph are just for reference and not for guarantee.

■ **Design Considerations**

● **Design guide**

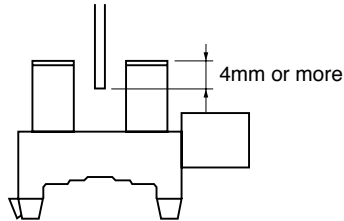
1) Prevention of detection error

To prevent photointerrupter from faulty operation caused by external light, do not set the detecting face to the external light.

2) Position of opaque board

Opaque board shall be installed at place 4mm or more from the top of elements.

(Example)



This product is not designed against irradiation and incorporates non-coherent IRED.

● **Degradation**

In general, the emission of the IRED used in photocouplers will degrade over time.

In the case of long term operation, please take the general IRED degradation (50% degradation over 5 years) into the design consideration.

● **Parts**

This product is assembled using the below parts.

• Photodetector (qty. : 1)

Category	Material	Maximum Sensitivity wavelength (nm)	Sensitivity wavelength (nm)	Response time (μs)
Phototransistor	Silicon (Si)	930	400 to 1 200	3

• Photo emitter (qty. : 1)

Category	Material	Maximum light emitting wavelength (nm)	I/O Frequency (MHz)
Infrared emitting diode (non-coherent)	Gallium arsenide (GaAs)	950	0.3

• **Material**

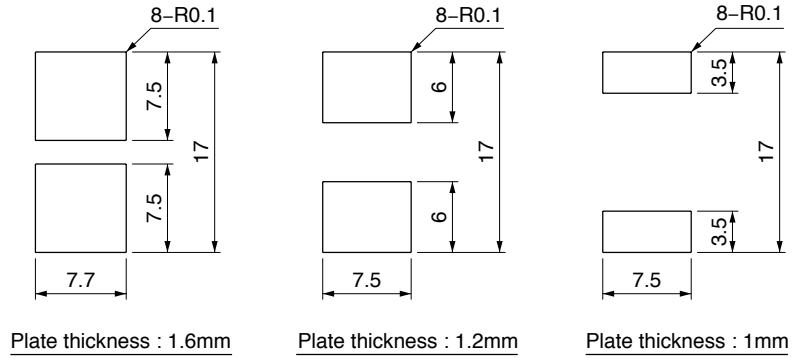
Case	Lead frame	Connector terminal finish
Black polycarbonate resin (UL94 V-2)	42Alloys (No plating)	Sn plating



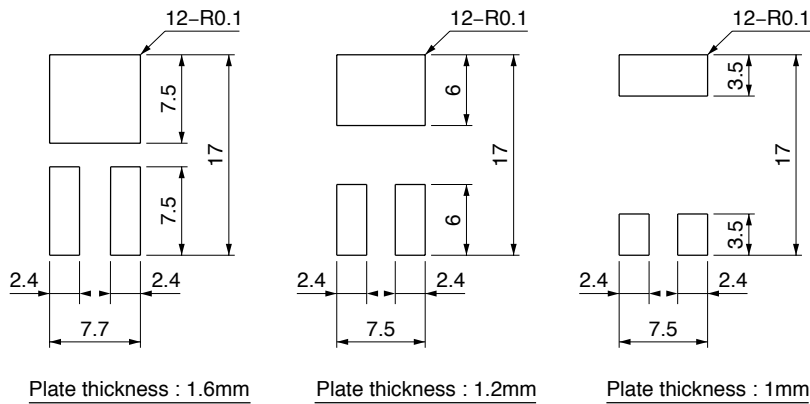
● **Recommended Installation Hole drawing**

- 1) We recommend to fix the product at punching side on the fixing plate (metal plate).
- 2) Please decide the final dimensions at your side after confirmation by the actual applications. Because mounting efficiency and mounted stabilization are dependent on mounting hole corner curve and punched state.
- 3) Tolerance shall be  $\pm 0.1\text{mm}$

**Normal type**



**Reverse-insertion prevention type**



---

**■ Manufacturing Guidelines****● Notes of cleaning**

Please carry out neither the immersion cleaning nor the ultrasonic cleaning to avoid the solvent residue inside the case.

When necessary, dust and stain shall clean by air-blow or wipe off by soft cloth soaked in cleaning agent. The cleaning agent used to wipe off must use only the following kind. Ethyl alcohol, Methyl alcohol and Isopropyl alcohol.

**● Presence of ODC**

This product shall not contain the following materials.

And they are not used in the production process for this product.

Regulation substances : CFCs, Halon, Carbon tetrachloride, 1.1.1-Trichloroethane (Methylchloroform)

Specific brominated flame retardants such as the PBBOs and PBBs are not used in this product at all.

This product shall not contain the following materials banned in the RoHS Directive (2002/95/EC).

•Lead, Mercury, Cadmium, Hexavalent chromium, Polybrominated biphenyls (PBB), Polybrominated diphenyl ethers (PBDE).

**■ Package specification****● Case package****Package materials**

Anti-static plastic bag : Polyethylene

Moltopren : Urethane

Partition : Corrugated fiberboard

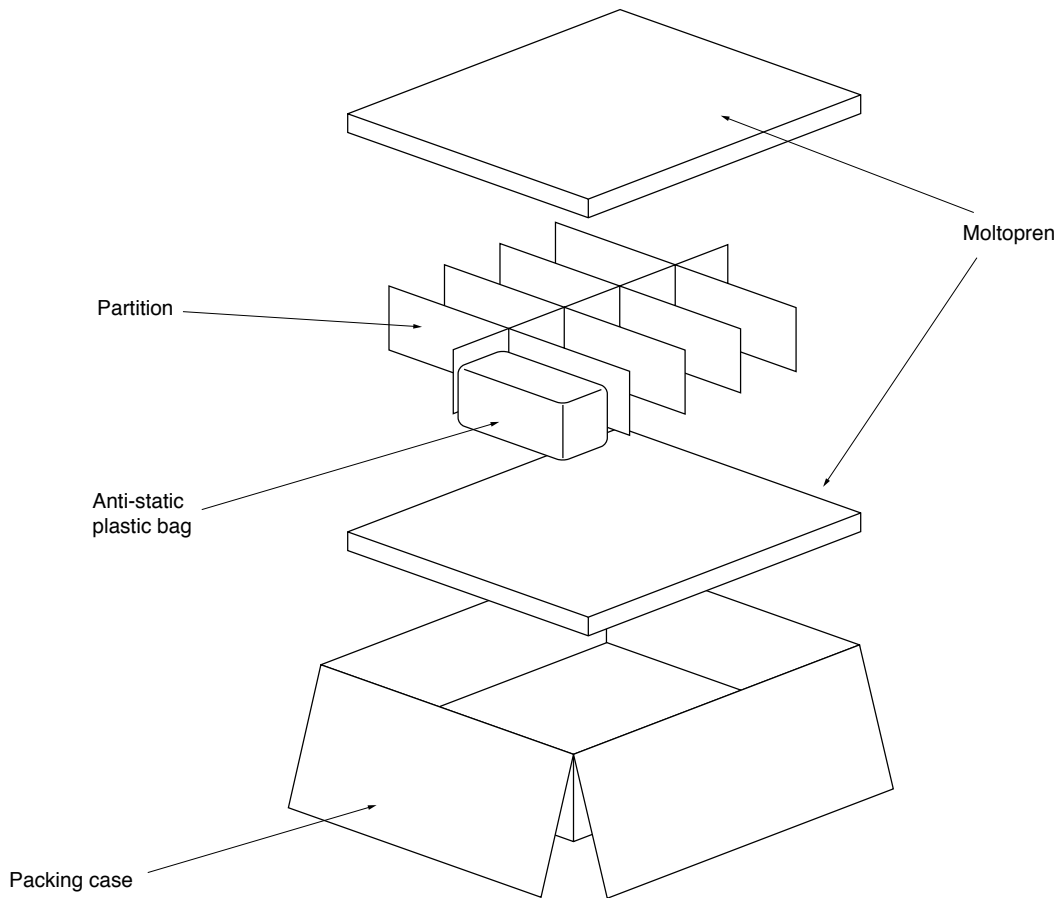
Packing case : Corrugated fiberboard

**Package method**

100 pcs of products shall be packaged in a plastic bag, Ends shall be sealed by stapler. The bottom of the packing case is covered with moltopren, and the partition is set in the packing case. Each partition should have 1 plastic bag.

The 10 plastic bags containing a product are put in the packing case.

Moltopren should be located after all product are settled (1 packing contains 1 000 pcs).

**Packing composition**

## ■ Important Notices

· The circuit application examples in this publication are provided to explain representative applications of SHARP devices and are not intended to guarantee any circuit design or license any intellectual property rights. SHARP takes no responsibility for any problems related to any intellectual property right of a third party resulting from the use of SHARP's devices.

· Contact SHARP in order to obtain the latest device specification sheets before using any SHARP device. SHARP reserves the right to make changes in the specifications, characteristics, data, materials, structure, and other contents described herein at any time without notice in order to improve design or reliability. Manufacturing locations are also subject to change without notice.

· Observe the following points when using any devices in this publication. SHARP takes no responsibility for damage caused by improper use of the devices which does not meet the conditions and absolute maximum ratings to be used specified in the relevant specification sheet nor meet the following conditions:

(i) The devices in this publication are designed for use in general electronic equipment designs such as:

- Personal computers
- Office automation equipment
- Telecommunication equipment [terminal]
- Test and measurement equipment
- Industrial control
- Audio visual equipment
- Consumer electronics

(ii) Measures such as fail-safe function and redundant design should be taken to ensure reliability and safety when SHARP devices are used for or in connection

with equipment that requires higher reliability such as:

- Transportation control and safety equipment (i.e., aircraft, trains, automobiles, etc.)
- Traffic signals
- Gas leakage sensor breakers
- Alarm equipment
- Various safety devices, etc.

(iii) SHARP devices shall not be used for or in connection with equipment that requires an extremely high level of reliability and safety such as:

- Space applications
- Telecommunication equipment [trunk lines]
- Nuclear power control equipment
- Medical and other life support equipment (e.g., scuba).

· If the SHARP devices listed in this publication fall within the scope of strategic products described in the Foreign Exchange and Foreign Trade Law of Japan, it is necessary to obtain approval to export such SHARP devices.

· This publication is the proprietary product of SHARP and is copyrighted, with all rights reserved. Under the copyright laws, no part of this publication may be reproduced or transmitted in any form or by any means, electronic or mechanical, for any purpose, in whole or in part, without the express written permission of SHARP. Express written permission is also required before any use of this publication may be made by a third party.

· Contact and consult with a SHARP representative if there are any questions about the contents of this publication.