

Average RMS AC Current Transducer

DIN RAIL / PANEL MOUNT, AVERAGE RMS



CR4410 CR4411 CR4420

Single Element - .79" Window
0.5 to 600 AAC Input Range



CR4450 CR4460

Two Element - .26" Window
0.5 to 30 AAC Input Range



CR4470 CR4480

Three Element - .26" Window
0.5 to 30 AAC Input Range

The **CR4400** Series, Current Transducers and Transmitters are designed to produce a DC output signal that is proportional to the average RMS input AC current. Designed for multi-point current sensing, these devices provide excellent features in a value package .

Applications

- Multi-point current sensing and control panels
- Monitor motor faults
- Monitor heating elements
- Monitor lighting elements

Features

- Low cost
- DIN rail or panel mount
- Available with 0-5 VDC, 0-10VDC or 4-20 mADC output
- High Accuracy
- Interfaces with most commercially available instrumentation
- Connection diagram printed on case

Regulatory Agencies

- Recognized to meet UL 61010B-1
- Constructed to meet CAN/CSA-C22.2, No. 61010-1-2004
- Meets requirement of IEC 61010-1 and BS EN 61010-1

C
Transducers



Use a 5 Amp Secondary
Current Transformer to extend
the ranges of all CR Magnetics
Current Transducers



All single phase current
transducers are available in split
core design. Simply put an "S"
at the end of the prefix*
I.E. CR4410S-10
* **Not UL Recognized**

PART NUMBERS

| | | | |
|-----------|---|--|--|
| CR4410(S) | - | | Single element with 0 - 5 VDC output (split core design) |
| CR4411(S) | - | | Single element with 0 - 10 VDC output (split core design)* |
| CR4420(S) | - | | Single element with 4 - 20 mADC output (split core design) |
| CR4450 | - | | Two element with 0 - 5 VDC output * |
| CR4460 | - | | Two element with 4 to 20 mADC output * |
| CR4470 | - | | Three element with 0 - 5 VDC output * |
| CR4480 | - | | Three element with 4 - 20 mADC output * |

Two and three element transducers are available only in ranges of 0.5 to 30 AAC

Add suffix for input range

- 5** - 0-5 AAC
- 10** - 0-10 AAC
- 15** - 0-15 AAC
- 20** - 0-20 AAC
- 25** - 0-25 AAC
- 30** - 0-30 AAC
- 40** - 0-40 AAC
- 50** - 0-50 AAC
- 75** - 0-75 AAC
- 100** - 0-100 AAC
- 150** - 0-150 AAC

Ranges available up to and including 600 AAC

SPECIFICATIONS

| | | | |
|-----------------------------|---------------------------------|-------------------------|---------------------------|
| Basic Accuracy:..... | 0.5% | Cleaning:..... | Water-dampened cloth |
| Linearity:..... | 10% to 100% FS | Relative Humidity:..... | 5% to 95%, Non-Condensing |
| Thermal Drift:..... | 500 PPM/°C | Supply Voltage:..... | 24 VDC ±10% |
| Operating Temperature:..... | 0°C to +60°C | Supply Current: | |
| Installation Category:..... | CAT II | CR4410/11..... | Typical 20mA Max 40mA |
| Vibration Tested To:..... | IEC 60068-2-6,1995 | CR4420..... | Typical 25mA Max 45mA |
| Pollution Degree:..... | 2 | CR4450..... | Typical 20mA Max 75mA |
| Response Time:..... | 250 ms max., 0-90% FS | CR4460..... | Typical 40mA Max 90mA |
| MTBF:..... | Greater than 100 K hours | CR4470..... | Typical 25mA Max 110mA |
| Altitude:..... | 2000 meter max. | CR4480..... | Typical 55mA Max 120mA |
| Calibration:..... | Average Sensing, RMS Calibrated | CR4410S..... | Typical ---mA Max ----mA |
| Insulation Voltage:..... | 2500 VDC | CR4420S..... | Typical ---mA Max ----mA |
| Power Source:..... | 24 VDC | Torque Specs:..... | 3.0 inch lbs. (0.4Nm) |
| Frequency Range:..... | 50Hz - 400Hz | Weight:..... | 0.5 lbs. |
| Output Load:..... | 4-20 mADC - 0 to 300 Ω | | |
| | 0-5 VDC - 2K Ω or Greater | | |

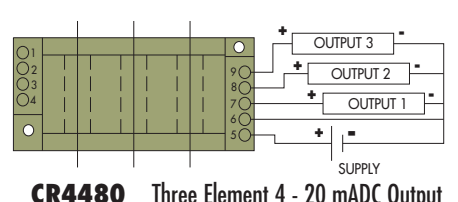
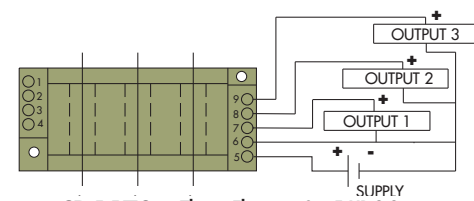
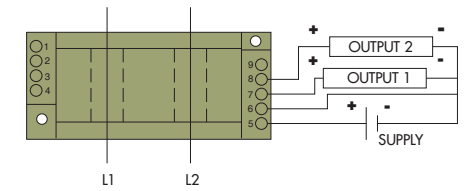
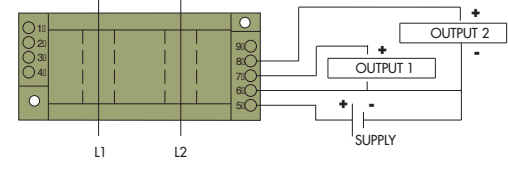
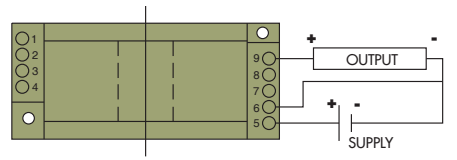
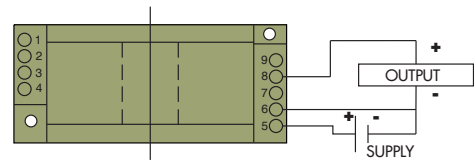
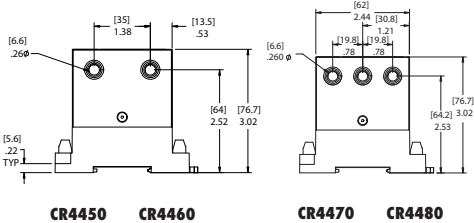
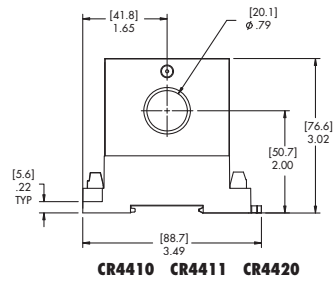
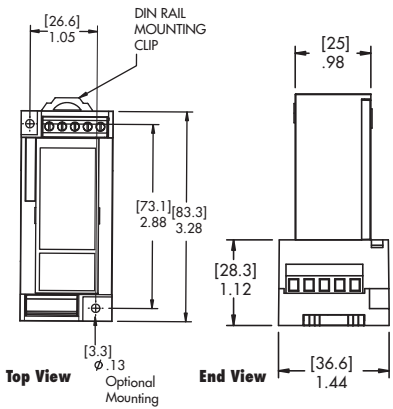

*Request CR Magnetics Low & Medium Voltage Current Transformers Catalog.

CONNECTION DIAGRAM

OUTLINE DRAWING

NOTE: The building installation must have a switch or circuit-breaker that is in close proximity and within easy reach of the operator. The switch or circuit breaker shall be marked as the disconnecting device for the equipment.



3500 Scarlet Oak Blvd. St. Louis MO USA 63122 V: 636-343-8518 F: 636-343-5119

Web: <http://www.crmagnetics.com>

E-mail: sales@crmagnetics.com